

Communication

Development and Testing of a 4-Columns Periodic Counter-Current Chromatography System Based on Membrane Adsorbers

Chantal Brämer ¹, Frank Lammers ², Thomas Scheper ¹ and Sascha Beutel ^{1,*}

¹ Institute of Technical Chemistry, Callinstraße 5, 30167 Hannover, Germany; braemer@iftc.uni-hannover.de (C.B.); scheper@iftc.uni-hannover.de (T.S.)

² Sanofi-Aventis Deutschland GmbH, 65926 Frankfurt am Main, Germany; frank.lammers@sanofi.com

* Correspondence: beutel@iftc.uni-hannover.de; Tel.: +49-511-762-2868

Received: 8 October 2019; Accepted: 20 November 2019; Published: 22 November 2019

Abstract: Continuous chromatography can surmount the disadvantages of batch chromatography like low productivities and extensive usage of consumables. In this work, a 4-column continuous chromatographic system based on the principle of periodic counter-current chromatography (PCCC) was developed and tested with a model protein mixture of BSA and lysozyme. The PCCC system was specially designed for membrane adsorbers as an alternative to conventional columns to facilitate the use of disposable process units and to further increase the productivity due to higher convective mass transport in the membrane adsorber. Membrane adsorber Sartobind® Q was used to continuously purify BSA from the protein mixture. The usage of PCCC led to an increased capacity utilization (here 20%) and higher space–time-yields, and thus to a remarkable productivity increase and cost savings.

Keywords: membrane adsorber; continuous chromatography; periodic counter-current chromatography

1. Introduction

The biotechnological industry produces biopharmaceuticals for the treatment of a wide variety of diseases like cancer or autoimmune diseases [1], enzymes for the detergent industry to achieve better cleaning performance [2], or for the production of fragrances for expensive perfumes [3]. The manufacturing process of a biotechnological product consists of cell cultivation (upstream processing), mostly of genetically modified microorganisms, yeasts, or mammalian cells and purification of the product (downstream processing). To date, the batch process is predominantly used for production, especially since it is easier to handle. Nevertheless, the batch has disadvantages such as the increased effort involved in operating, emptying, and refilling to start a new batch. This leads to long downtimes between batches. Thus, the batch process is not very efficient. Therefore, the trend is moving toward continuous processing as a continuous process is more efficient and achieves higher space–time-yields [1,4,5]. When considering the cost distribution for the production of a biotechnological product, it is noticeable that the purification of the product is unequally distributed with up to 80% of the total production costs [6]. Therefore, the interest in continuous processes is increasing, especially in the field of chromatography as the method of choice [7]. Continuous chromatography is intended to remedy limited productivities by increasing the capacity utilization and decreasing the usage of consumables, thus leading to higher space–time-yields [5,8–10]. However, the introduction of continuous processes involves hurdles: planning, setup, and handling are much more complex than for batch processes [1,11].

The first continuous multi-column chromatography was carried out in the 1920s (merry-go-round installation). The system consisted of three chromatography units, of which two were always loaded and one was regenerated. The two chromatography units were connected in a row so that the product breakthrough of the first chromatography unit was captured on the second chromatography unit. This method allowed an improvement in capacity utilization and continuous sample introduction. In the 1950s, various methods for continuous chromatography were developed, mainly to purify metals or wastewater by liquid–liquid extraction [12]. These (chromatography) methods were based on the counter-current principle: the mobile and stationary phases move in opposite directions. The sample to be separated is applied in the middle of the chromatography unit and the separated substances can be collected at the ends of the chromatography unit. First, true moving bed (TMB) liquid–liquid chromatography was implemented, and finally simulated moving bed (SMB) chromatography was developed [10]. Further examples of continuous methods are continuous annular chromatography [7] and periodic counter-current chromatography [4,8,13,14]. SMB [15] and periodic counter-current chromatography (PCCC) are pseudo-continuous methods, since the counter-current is simulated using the column switching approach. Usually, these continuous methods are operated with chromatographic columns. In this work, the PCCC was run with membrane adsorbers, which will be explained in more detail shortly. In PCCC, up to two chromatography units are loaded in series to capture the product breakthrough of the first chromatography unit on the second chromatography unit. The UV signal of the breakthrough curve serves as the dynamic control strategy for automation (see Figure 1, operated with membrane adsorbers). This mode of operation allows for the chromatography unit to be loaded close to the static binding capacity (available capacity of the chromatography unit in equilibrium) and thus results in a higher capacity utilization of the chromatography unit [1,2,8,9].

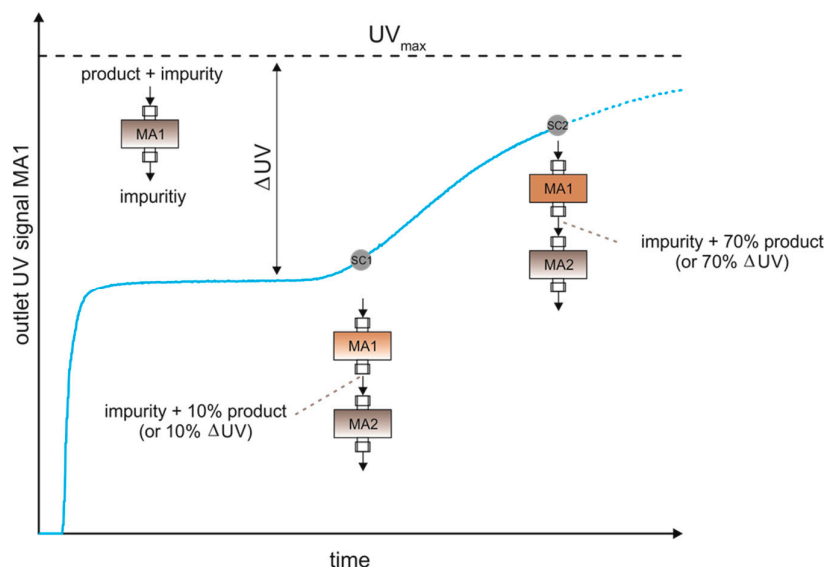

Figure 1. Loading principle of periodic counter-current chromatography operated with membrane adsorbers.

M. Hall and K. Lacki (GE Healthcare Bio-Sciences AB) patented (WO 2008/153472 A1) a semi-continuous chromatography method based on the PCCC principle. The system can be operated with three (3C-PCC) or four (4C-PCC) chromatography units. GE Healthcare offers the commercial system ÄKTA™ pcc 75, which is based on the ÄKTA™ avant system and is operated with Unicorn software. The system can be operated with flow rates up to 75 mL/min and contains a UV measurement after each chromatography unit (at 280 nm) as well as sensors for pH and conductivity measurement.

Some examples of 3C-PCC or 4C-PCC application can be found in the literature, mainly for the purification of monoclonal antibodies [16–19]. In addition, a few other applications are used such as

desalting, virus purification, plasma protein purification [16], purification of unstable proteins [8], lipase [2], and a sesquiterpene synthase purification [3].

In addition to the hardware development described above, new chromatography materials and ligands have been developed to overcome the limitation of mass transport in conventional columns by diffusion. Recent developments have made membrane chromatography particularly interesting for the purification of biomolecules [20]. (Disposable) membrane adsorbers (MA) [12] can be used in continuous low-pressure chromatography systems. The ligands are attached to the membrane surface so that the mass transport is mainly due to convection and not to pore diffusion [21]. The capacity of membrane adsorbers is independent of the flow rate [14] and thus enables higher throughputs or the processing of lower product titers up to a few g/L. Nevertheless, the breakthrough capacities of conventional columns and membrane adsorbers are comparable [22]. In addition, the up- and down-scale of membrane adsorbers is simple because the capacity depends only on the membrane surface [23]. A continuous chromatography system, in which MA can be operated as an alternative to classical columns, could further increase productivity of a purification process [24,25]. This applies particularly to the purification of special pharmaceuticals or highly valuable proteins from complex mixtures such as antibodies, proteins from human serum, growth factors, etc.

In this work, a new PCCC system was developed and tested using MA devices instead of conventional chromatography columns. The MA offers the advantages of being disposable and can be easily exchanged. Furthermore, cleaning and validation costs are eliminated through the use of disposables. The PCCC system setup in this study was designed for four MA units and was equipped with a flexible UV measurement in the range from 230–650 nm. The 4MA-PCCC system can be operated with the interconnected wash, which is very important to avoid product loss [26], in comparison to the previously developed 3MA-PCCC system. In the course of its development, the PCCC system was redesigned to be compact and portable. In addition, a GUI (graphical user interface) was developed to increase usability. In this work, the continuous purification of a model protein mixture of BSA (bovine serum albumin) and lysozyme was performed to evaluate the continuous chromatography system. BSA ($pI = 4.7$) and lysozyme ($pI = 11.4$) were chosen because of their different pI (isoelectric point) values, which makes purification by ion exchange chromatography very easy. Therefore, the anion exchange membrane adsorber Sartobind® Q was used to bind BSA at $pH 7$ due to its negative surface net charge.

2. Materials and Methods

2.1. Materials

BSA and lysozyme were purchased from Sigma-Aldrich (now Merck, Darmstadt, Germany) of a technical purity grade. All other chemicals were bought from Carl-Roth (Karlsruhe, Germany).

2.2. Methods

2.2.1. Protein Purification

The batch purification was performed using the commercial system ÄKTA™ pure (GE Healthcare, Uppsala, Sweden). In this study, the membrane adsorber (MA) Sartobind® Q (anion-exchange chromatography) was used to bind BSA. The membrane adsorber has a surface area of 75 cm² and a membrane volume of 2.1 mL. The dynamic binding capacity for BSA was 54.2 mg and the static binding capacity was 73.5 mg per unit.

The model proteins BSA and lysozyme were diluted in binding buffer (20 mM KH₂PO₄-buffer $pH 7.0$) to the desired concentration. Elution was performed by adding 0.5 M NaCl. For continuous purification, a chromatographic (PCCC) system with four membrane adsorbers was used. The PCCC system and procedure is further described in Section 3.1.

2.2.2. Protein Quantification

For protein quantification, Bradford assay was performed using the reagent Roti®-Quant (Carl-Roth). A 20 µL sample was mixed with 300 µL of the reagent in a 96-well plate. Incubation was performed for 5 min. At 595 nm, detection was carried out with Multiskan GO. BSA and lysozyme standards in the range of 0.0125–0.2 g/L BSA and 0.0125–0.75 g/L lysozyme were measured for calibration.

2.2.3. Qualitative Analysis Using SDS-PAGE

SDS-PAGE (sodium dodecyl sulfate polyacrylamide gel electrophoresis) was used for qualitative analysis of the purification. The gel consisted of a stacking gel (6%) and a separating gel (15%). The gel was run for 15 min at 100 V and 1.5 h at 150 V. Samples were diluted 1:1 with Lämmli buffer and boiled for 10 min at 95 °C. A sample of 5 µL of the marker (Unstained Protein Molecular Weight Marker, Thermo Fisher Scientific, Waltham, MA, USA) and 10 µL of the sample was applied onto the gel.

3. Results

In previous work, a PCCC system was developed and tested with three membrane adsorbers (3MA-PCCC) and a simple schedule. This system was further used for the purification of two industrial relevant proteins *Candida Antarctica* lipase B [2] and patchoulol synthase [3]. In these experiments, product was lost in the washing steps. To recover more product and increase effectivity, the interconnected wash [2,18,26] was implemented, meaning that the wash fraction is passed through another MA. Therefore, a fourth chromatography unit with measurement system was added to the PCCC system. After installation and reconstruction, the new 4MA-PCCC device was tested with the model proteins BSA and lysozyme and put into operation for the separation of a simple two-component system. Due to the different isoelectric points of BSA and lysozyme, BSA can be separated specifically by an anion-exchange membrane adsorber (Sartobind® Q).

3.1. System Setup

The 3MA-PCCC system components (pump, valves, UV measurement) were described in Brämer et al., (2018) whereas the 4MA-PCCC fraction collector was changed to a BioFrac™ Fraction Collector and 16 additional 3–2-way valves (The Lee company, Westbrook, CT, USA) were added. Furthermore, a fourth UV measurement unit and UV flowthrough cuvettes with a pathlength of 2 mm (Hellma Analytics, Müllheim, Germany) can also be used in the system. Different pathlengths are useful when maintaining different purification tasks. In this work, 2 mm cuvettes were used. The PCCC system circuit diagram is shown in Figure 2.

3.2. Integration of SiLA2 and Blockly

The PCCC system consists of various components that are addressed in the program scripts using python™. Due to the complexity of the device, the program script is very long. To simplify the operation for the user, Blockly was implemented. Blockly is a graphical tool developed by Google Developers that uses simple graphical tools that create syntactically correct source code. The user can create a method by selecting the required blocks and entering values, for example, pump rates. To guarantee standardized device communication, SiLA 2 was implemented. SiLA 2 is a standard driver protocol and was developed to ensure compatibility of laboratory systems and here, enables the user to access the functionality of the system in a uniform way.

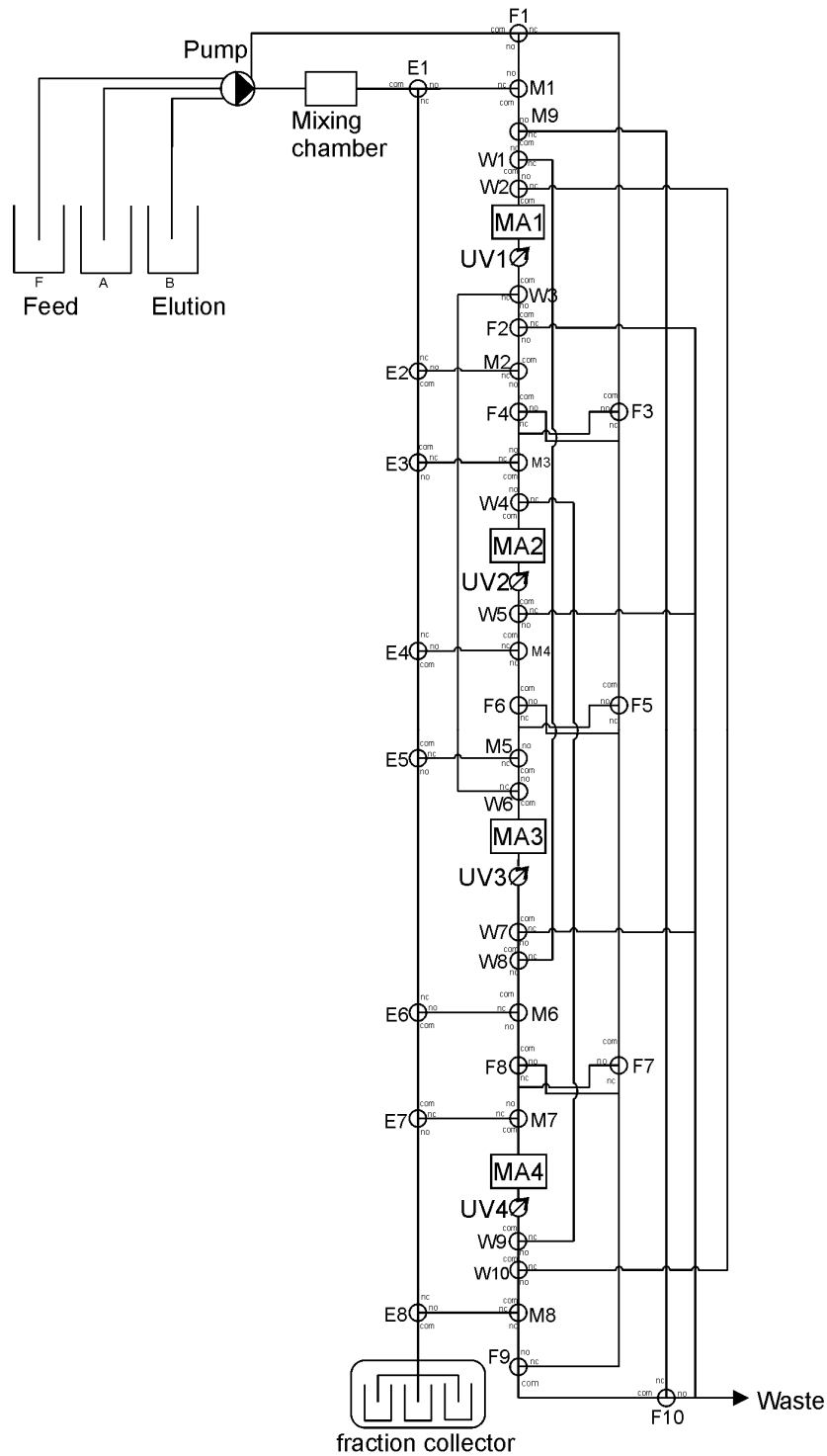

Figure 2. Circuit diagram of the periodic counter-current chromatography system with four membrane adsorber units.

3.3. Continuous Chromatography with Model Proteins

Protein concentrations of the model purification task were chosen according to the calibration data (Appendix A, Figure A1) for BSA and lysozyme. A total of 5 g/L BSA and 1.25 g/L lysozyme was used to achieve a double breakthrough curve so that the UV signal could be used to control the process. By continuously applying the protein mixture onto a MA, a double breakthrough can be recorded at the outlet of the MA (see Figure 1). The impurity (here lysozyme) breaks through while

BSA binds to the MA. When the MA is slowly saturated with BSA, BSA (here the product) also breaks through and can be measured at the outlet. The aim is to represent the PCCC process as displayed in Figure 3.

As described in Figure 1, in step 1, MA 1 is loaded until a certain amount of the product breaks through (here 10%, SC1). The process switches to step 2 and MA 2 is added to the load. The breakthrough from MA 1 is then bound to MA 2. The second step stops when MA 1 is saturated with product [4,5] (here 70%, SC2). The MA is decoupled from the circuit, the product is eluted, and the MA is regenerated and fed back into the circuit. The procedure described for MA 1 is continued with MA 2 to 4, resulting in the process schedule in Figure 3 [13]. By washing, eluting, and regenerating (displayed in grey) in parallel to the loading (displayed in light blue), the process can begin again at step 1 after step 8 [8]. Steps 1 to 8 show the nested cyclic process of the 4MA-PCCC. By linking two MA units, the loading can be carried out quasi-continuously. Furthermore, by linking the units, loading takes longer and thus more capacity is used without product being lost. In contrast to the 3MA-PCCC system [2], this 4MA-PCCC system can be used with the interconnected wash. This means that the wash after loading is applied on a further MA to increase the product yield while the feed stream is applied continuously. This can be seen, for example, in step 3 for MA 1. After loading in steps 1 and 2, a wash step is performed in step 3. Unbound product is captured on MA 3 and the loss is consequently reduced. As already described [17], there are the following degrees of freedom for the operation of the PCCC: the pump rates of the feed and the buffers A and B.

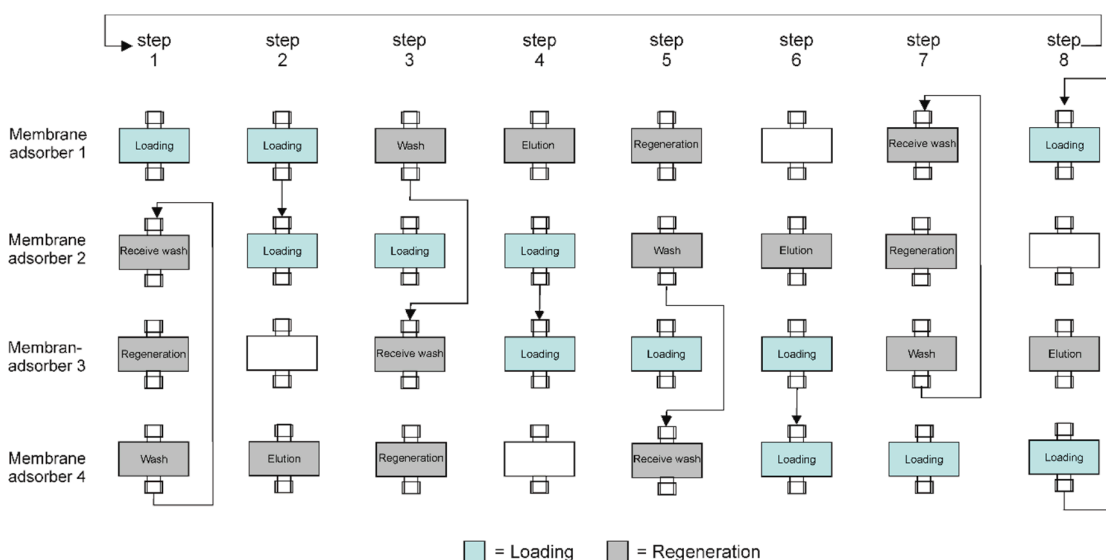

Figure 3. Schematic schedule for the continuous chromatography with four membrane adsorbers. Four membrane adsorbers are loaded, washed, and regenerated in eight steps based on the periodic counter-current principle. Thus, quasi-continuous processing is realized by loading the membrane adsorbers in a sequential and cyclic manner.

3.3.1. Time-Controlled Process (Static Control)

At first, a simplified experiment was performed to check if the 4MA-PCCC system setup (especially the complex circuit and program script) fulfills the requirements for PCCC. Therefore, a time-controlled (static control) experiment was performed, which can be seen in Figure 4a. The feed rate was set to 0.5 mL/min as the BSA concentration was quite high with 5 g/L. The pump rates for buffer A and B were set to 8.6 mL/min (maximum pump rate with utilized tubing). The chromatography was run at room temperature. Each step of the continuous process from Figure 3 was maintained for 5 min. During the experiment, 105 mL feed containing 5 g/L BSA and 1.25 g/L lysozyme were purified within 3.5 h and four PCCC-cycles. The chromatogram in Figure 4a shows the absorption at 280 nm of the four sequentially loaded membrane adsorbers. Uniform breakthroughs and elution peaks can be seen, which indicate that the circuit and programming was

correctly implemented: both the loading of the four MA as well as the implementation of the interconnected wash were successful.

3.3.2. Dynamic Control with UV-Signal

The 4MA-PCCC system is to be used by running it with the dynamic control using the UV-signal at 280 nm. The UV-signal provides information on how much of the MA's capacity has already been used. The capacity can be used more efficiently by setting the switching conditions SC1 and SC2 [4,8]. SC1 corresponds to the dynamic binding capacity whereas SC2 corresponds to a nearly saturated MA (Figure 1). These were calculated as follows:

$$SC1 = 10\% \cdot \Delta UV + UV_{\text{lysozyme/impurity}} = 0.51 \text{ AU} \quad (1)$$

$$SC2 = 70\% \cdot \Delta UV + UV_{\text{lysozyme/impurity}} = 0.84 \text{ AU} \quad (2)$$

where ΔUV is the difference between the UV-signal of the protein mixture or feed (UV_{max}) and the UV-signal of lysozyme (here $UV_{\text{lysozyme/impurity}}$).

A total of 80 mL protein solution with 5 g/L BSA and 1.25 g/L lysozyme (feed) was used for the dynamically controlled experiment. This required 1.8 L buffer (equilibration and elution buffer) for the washing, elution, and regeneration phases. Two PCCC cycles were performed in 2.75 h. Product recovery was over 90%.

The two cycles are shown in Figure 4b. The expected double breakthroughs of the four MA can be seen. The elution peaks were above 1.5 AU in the non-linear range. Therefore, no statement can be made about the different heights of the peaks between membrane adsorbers 1, 2, 3, and 4. The capacity utilization under these conditions was increased by about 20% (see Appendix A, Figure A2). Compared to the batch process, a cost saving of about 17% with regard to the chromatography unit could be achieved.

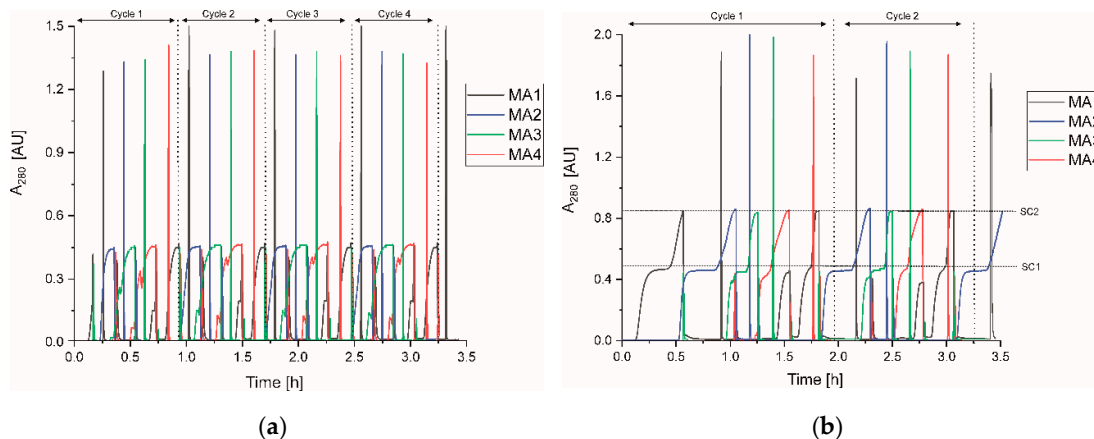

Figure 4. Chromatogram of continuous run with temporal control, duration of one phase is 5 min (a) and dynamic control (b).

4. Discussion

This study depicts the successful establishment of a PCCC device operated with four membrane adsorbers, enabling the use of disposable process units. The measurement components were optimized for the intended use so that the UV measurement is very flexible and changeable flowthrough cuvettes (2 mm and 10 mm) can be used, depending on the purification process. The optimized 4MA-PCCC system was successfully tested with BSA and lysozyme as the model purification task, whereas BSA was bound to the MA Sartobind Q[®] MA75. This strong anion exchange membrane adsorber was selected as BSA has a negative surface net charge in the selected buffer and thus binds to the membrane adsorber. With the system static, dynamic control is possible and protein concentrations in the absorption range of 0.01–1.5 AU can be measured.

The application example with model proteins enabled a higher space–time–yield compared to batch chromatography, which was reached by increased capacity utilization (20%). Furthermore, buffer and time savings were achieved using the PCCC. The feasibility and performance depend on the individual process, respective product, and impurities to separate, and therefore needs to be investigated in detail before applying the continuous system. It is important for the PCCC to have a high product concentration in the feed for the dynamic control via UV-signal. It must be sufficiently high and measurable in relation to the impurities, so that the dynamic process control is possible. Here, a high concentration with 5 g/L BSA was used, whereas only 1.25 g/L lysozyme were added as an impurity. It should be noted that this concentration ratio is further dependent on the extinction coefficient at 280 nm, which differs for every product. Furthermore, the feed to be purified may contain various contaminants. These can be host cell proteins, media components, DNA, etc.; all of these have different absorption behaviors. Specific online measurement methods could be used to detect the product (e.g., fluorescence for either aromatic amino acid-rich proteins or fluorescent proteins). The PCCC is particularly suitable for the purification of secreted proteins from mammalian cells or microorganisms, whereby the ratio of product to impurity is decisive. In particular, the purification of highly valuable products leads to significant process cost savings.

5. Conclusions

In this study, a model protein mixture of BSA and lysozyme was purified with an advanced 4MA-PCCC. The system had decisive advantages over the previously developed 3MA-PCCC. Due to the extended design, the yield could be increased, particularly because the so-called interconnected wash was implemented. Due to the graphical user interface and the integration of a method editor, the implementation was easy for the user and thus meets the current standards. In particular, the use of SiLA2 is advantageous, because the connection to other devices is possible via this standardized device control. This is crucial with regard to integrated or continuous processes from upstream and downstream processing.

Author Contributions: Conceptualization, C.B. and S.B.; Methodology, C.B.; Software, C.B.; Formal analysis, S.B.; Investigation, C.B.; Resources, T.S. and S.B.; Writing—original draft preparation, C.B.; Writing—review and editing, F.L., T.S., and S.B.; Visualization, C.B.; Supervision, T.S. and S.B.; Project administration, S.B.; Funding acquisition, S.B.

Funding: Part of this work was funded by the German Federal Ministry of Education and Research (BMBF, funding number: 031B0463C).

Acknowledgments: The authors would like to thank Laura Niemeyer for her work on Blockly GUI. The publication of this article was funded by the Open Access fund of Leibniz Universität Hannover.

Conflicts of Interest: The authors have declared no conflicts of interest.

Appendix A

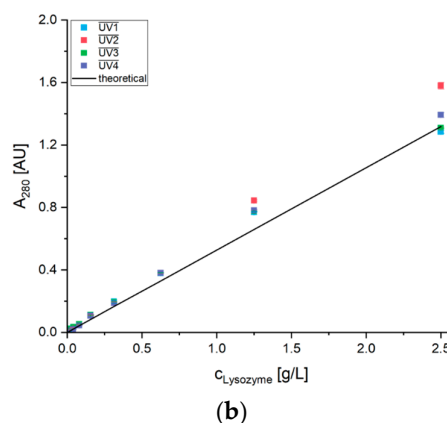
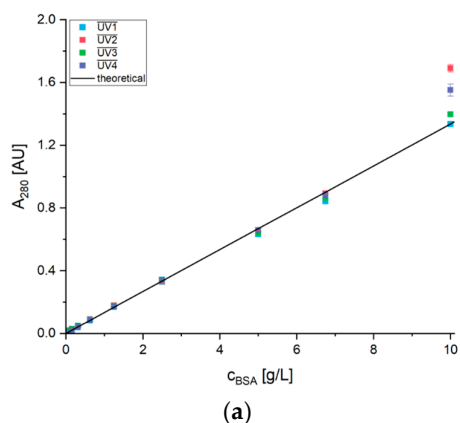

Figure A1. Calibration data of the four UV measurements at 280 nm with BSA (bovine serum albumin) (a) and lysozyme (b) using a pathlength of 2 mm.

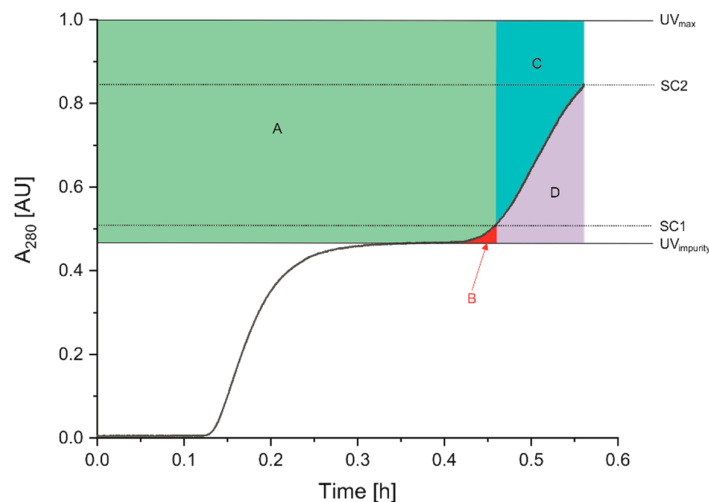

Figure A2. Capacity utilization in periodic counter-current chromatography vs. batch chromatography. (A) Bound product batch; (B) product loss batch; (C) further product bound in continuous chromatography on first chromatography unit; (D) product bound on second chromatography unit.

References

- Ozturk, S.S. Opportunities and Challenges for the Implementation of Continuous Processing in Biomanufacturing. *Contin. Process. Pharm. Manuf.* **2014**, *457–478*, doi:10.1002/9783527673681.ch18.
- Brämer, C.; Schreiber, S.; Scheper, T.; Beutel, S. Continuous purification of *Candida antarctica* lipase B using 3-membrane adsorber periodic counter-current chromatography. *Eng. Life Sci.* **2018**, *18*, 414–424.
- Brämer, C.; Ekramzadeh, K.; Lammers, F.; Scheper, T.; Beutel, S. Optimization of continuous purification of recombinant patchouli synthase from *Escherichia coli* with membrane adsorbers. *Biotechnol. Prog.* **2019**, 1–10. doi:10.1002/btpr.2812.
- Warikoo, V.; Godawat, R.; Brower, K.; Jain, S.; Cummings, D.; Simons, E.; Johnson, T.; Walther, J.; Yu, M.; Wright, B.; et al. Integrated continuous production of recombinant therapeutic proteins. *Biotechnol. Bioeng.* **2012**, *109*, 3018–3029.
- Heeter, G.A.; Liapis, A.I. Perfusion chromatography: Performance of periodic countercurrent column operation and its comparison with fixed-bed operation. *J. Chromatogr. A* **1995**, *711*, 3–21.
- Pathak, M.; Ma, G.; Bracewell, D.G.; Rathore, A.S. Re-use of protein A resin: Fouling and economics. *BioPharm Int.* **2015**, *28*, 28–33.
- Wolfgang, J.; Prior, A. Continuous Annular Chromatography. *Modern Advances in Chromatography* **2002**, *76*, 233–255.
- Godawat, R.; Brower, K.; Jain, S.; Konstantinov, K.; Riske, F.; Warikoo, V. Periodic counter-current chromatography—design and operational considerations for integrated and continuous purification of proteins. *Biotechnol. J.* **2012**, *7*, 1496–1508.
- Janson, J.-C. *Protein Purification: Principles, High Resolution Methods, and Applications*; John Wiley & Sons: Hoboken, NJ, USA, 2012; Volume 151.
- Rajendran, A.; Paredes, G.; Mazzotti, M. Simulated moving bed chromatography for the separation of enantiomers. *J. Chromatogr. A* **2009**, *1216*, 709–738.
- Whitaker, S.C.; Francis, R.; Siegel, R.C. Validation of Continuously Perfused Cell Culture Processes for Production of Monoclonal Antibodies. In *Validation of Biopharmaceutical Manufacturing Processes*; American Chemical Society: Washington, DC, USA, 1998; Volume 698, pp. 3–28.
- Bisschops, M. Bio SMB™ Technology: Continuous Countercurrent Chromatography Enabling a Fully Disposable Process. *Biopharm. Prod. Technol.* **2012**, *1*, 769–791.
- Steinebach, F.; Müller-Späth, T.; Morbidelli, M. Continuous counter-current chromatography for capture and polishing steps in biopharmaceutical production. *Biotechnol. J.* **2016**, *11*, 1126–1141.

14. Skoglar, H.; Blom, H.; Mathiasson, L.; Akerblom, A.; Łącki, K. The use of dynamic control in periodic counter-current chromatography. *Bioprocess Int.* **2015**, *13*, 29150261.
15. Heuer, C.; Küsters, E.; Plattner, T.; Seidel-Morgenstern, A. Design of the simulated moving bed process based on adsorption isotherm measurements using a perturbation method. *J. Chromatogr. A* **1998**, *827*, 175–191.
16. Mathiasson, L.; Skoglar, H.; Berg, M.; Sichtung, M.; Chmielowski, R.; Forma, E.; Nordvarg, H. Continuous chromatography beyond affinity capture of monoclonal antibodies. **2017**.
17. Baur, D.; Angarita, M.; Müller-Späth, T.; Steinebach, F.; Morbidelli, M. Comparison of batch and continuous multi-column protein A capture processes by optimal design. *Biotechnol. J.* **2016**, *11*, 920–931.
18. Pollock, J.; Bolton, G.; Coffman, J.; Ho, S.V.; Bracewell, D.G.; Farid, S.S. Optimising the design and operation of semi-continuous affinity chromatography for clinical and commercial manufacture. *J. Chromatogr. A* **2013**, *1284*, 17–27.
19. El-Sabbahy, H.; Fagan, L.; Nancollis, V. Factors affecting the productivity of 4-Column Periodic Counter Current Chromatography (4C-PCC). **2015**.
20. Rathore, A.S.; Kateja, N.; Agarwal, H. Continuous Downstream Processing for Production of Biotech Therapeutics. *Continuous Biomanufacturing: Innov. Technol. Methods* **2017**, 261–288, doi:10.1002/9783527699902.ch10.
21. Knudsen, H.L.; Fahrner, R.L.; Xu, Y.; Norling, L.A.; Blank, G.S. Membrane ion-exchange chromatography for process-scale antibody purification. *J. Chromatogr. A* **2001**, *907*, 145–154.
22. Gebauer, K.H.; Thömmes, J.; Kula, M.R. Breakthrough performance of high-capacity membrane adsorbers in protein chromatography. *Chem. Eng. Sci.* **1997**, *52*, 405–419.
23. Demmer, W.; Nussbaumer, D. Large-scale membrane adsorbers. *J. Chromatogr. A* **1999**, *852*, 73–81.
24. Mothes, B.; Pezzini, J.; Schroeder-Tittmann, K.; Villain, L. Accelerated, seamless antibody purification. *Bioprocess. Int.* **2016**, *14*, 5.
25. Zobel-Roos, S.; Stein, D.; Strube, J. Evaluation of Continuous Membrane Chromatography Concepts with an Enhanced Process Simulation Approach. *Antibodies* **2018**, *7*, 13.
26. Mahajan, E.; George, A.; Wolk, B. Improving affinity chromatography resin efficiency using semi-continuous chromatography. *J. Chromatogr. A* **2012**, *1227*, 154–162.



© 2019 by the authors. Licensee MDPI, Basel, Switzerland. This article is an open access article distributed under the terms and conditions of the Creative Commons Attribution (CC BY) license (<http://creativecommons.org/licenses/by/4.0/>).