

Cancer proteomics of mouse serum and liver tissue samples
to discover candidate biomarkers for
hepatocellular carcinoma (HCC) in c-Myc transgenic mice

Von der Naturwissenschaftlichen Fakultät
der Gottfried Wilhelm Leibniz Universität Hannover
zur Erlangung des Grades
Doktorin der Naturwissenschaften

Dr. rer. nat.

genehmigte Dissertation von

Dottore in Farmacia

Maria Stella Ritorto

geboren am 27.09.1979 in Rom (Italien)

Referent:

Prof. Dr. Juergen Borlak
Lehrstuhl fuer Pharmaco- und Toxikogenomik
Medizinische Hochschule Hannover

Abteilung Molekulare Medizin und Medizinische Biotechnologie
Fraunhofer Institut fuer Toxikologie und Experimentelle Medizin

Korreferent:

Prof. Dr. Rer. Nat. Juergen Alves
Biophysikalische Chemie
Medizinische Hochschule Hannover

Tag der Promotion:

10. Februar 2011

Die vorliegende Arbeit wurde in der Zeit von 2006 bis 2010 am Fraunhofer Institut für Toxicologie und Experimentelle Medizin in Hannover in der Abteilung für Molekulare und Medizinische Biotechnologie angefertigt.

Erklärung:

Hiermit erkläre ich, dass ich diese Dissertation selbstständig verfasst und alle benutzten Hilfsmittel und Quelle sowie gegebenenfalls die zu Hilfeleistung herangezogene Institutionen vollständig angegeben habe.

Diese Dissertation wurde nicht schon als Masterarbeit, Diplomarbeit oder andere Prüfungsarbeit verwendet.

Hannover, im November 2010

Acknowledgments

The work behind this dissertation has been an incredible journey and a monumental milestone in my academic life. I could not have embarked on this expedition and travelled this far without the passionate and continued support of advisors, colleagues, friends and family.

First of all,

.....I would like to express my gratitude to Professor Jürgen Borlak, my main dissertation advisor and supervisor. Over the past four years, we had numerous conversations and electronic exchanges that constantly improved and refined this work.

A big gratitude

.....goes to Professors Uwe Heinrich and Clemens Dasenbrock from Fraunhofer Institute for Toxicology and Experimental Medicine who were of great importance in finalizing this work and make it true.

Moreover, I thank

.....Professors Jürgen Alves and Andreas Pich for their particular kindness in accepting to be my Coreferent and third Examiner, as well as Prof Christoph Peterhaensel for moderating the defence.

.....Professor Arndt Vogel and his collaborators Jutta Lamle and Silke Marhenke, for their professional help in clinical studies.

.....Among my colleagues, Kathrin Hoffmeyer for genomic data, as well as Gudrun Muehlbauer and Kathrin Eidenschink for the optimum technical support in IHC analysis.

In particular,

.....I would like to thank Dott Ignazio Garaguso, Dr. Bijon Chatterji, Dr. Roman Halter as well as Eckhard Belau which were more than colleagues and they gave colour to my hard task.

This extraordinary voyage would certainly have been less extraordinary and colorful if not for the engaging and heartwarming time spent with my fantastic friends, Tatjana, Christine, Dietmar and Luan, along to all my Italian and other European crew of friends: to them, I want to say thank for supporting my dark moments and giving a spread of smiles. I will be thankful to them forever.

Vorrei ringraziare in particolare Ignazio, con cui ho condiviso tutto il dottorato e a cui devo molto, poiché è grazie al suo supporto professionale che sono riuscita a raggiungere la meta.

Il ringraziamento piú grande é rivolto alla mia famiglia ed in particolare ai miei fantastici genitori, con cui ho condiviso gioie e dolori di questo dottorato e senza cui non ce l'avrei mai potuta fare.

To my parents, for their love

(Ai miei genitori, per il loro amore)

Contents

ABSTRACT	1
KURZZUSAMMENFASSUNG	3
INTRODUCTION	5
THEORY	7
THE ROLE OF MYC TRANSCRIPTION FACTOR IN NORMAL BIOLOGY AND CANCER	8
Myc biological functions	11
Myc and cancer.....	12
HEPATOCELLULAR CARCINOMA.....	16
Diagnosis of HCC	17
Treatment of HCC.....	18
The role of c-Myc in HCC.....	19
Biomarkers for HCC.....	19
Animal models of HCC.....	20
A c-Myc transgenic mouse model of HCC.....	22
PROTEOMICS-BASED BIOMARKER DISCOVERY.....	23
AIMS OF THE DOCTORAL THESIS	29
APPLIED METHODS	31
MANTAINANCE OF TRANSGENIC MICE.....	32
PATIENT CHARACTERISTICS	32
TISSUE AND SERUM PROTEOME ANALYSIS.....	34
<i>Protein separation and quantitation by 2-DE</i>	35
<i>MALDI-TOF/TOF mass spectrometry</i>	39
VALIDATION OF PROTEIN REGULATIONS.....	41
<i>Western immunoblotting</i>	41
<i>Immunohistochemistry</i>	41
GENE EXPRESSION DATA OF REGULATED PROTEINS	42
BIOINFORMATICS	43
<i>Search for c-Myc binding sites in promoters of regulated genes/proteins</i>	43
<i>GPI-anchored protein predictors</i>	44
<i>Gene Ontology</i>	44
RESULTS & DISCUSSION	45
PART 1: “ <i>A SIMPLE AND RELIABLE PROTOCOL FOR MOUSE SERUM PROTEOME PROFILING STUDIES BY USE OF TWO-DIMENSIONAL ELECTROPHORESIS AND MALDI TOF/TOF MASS SPECTROMETRY</i> ”	46
PART 2: “ <i>A COMBINED SERUM AND TISSUE PROTEOMIC STUDY APPLIED TO A C-MYC TRANSGENIC MOUSE MODEL OF HEPATOCELLULAR CARCINOMA IDENTIFIED NOVEL DISEASE REGULATED PROTEINS SUITABLE FOR DIAGNOSIS AND THERAPEUTIC INTERVENTION STRATEGIES</i> ”	54
PART 3: “ <i>INDUCTION OF THE GPI-SPECIFIC PHOSPHOLIPASE D SIGNALLING IN A C-MYC TRANSGENIC MOUSE MODEL OF HEPATOCELLULAR CARCINOMA</i> ”	76
CONCLUSIONS	85
BIBLIOGRAPHY	88
WEBGRAPHY	102
TABLES	109
APPENDICES	I
APPENDIX 1: C-MYC EXPRESSION IN LIVER TISSUE BY IHC.....	II
APPENDIX 2: IMMUNOHISTOCHEMISTRY OF REGULATED PROTEINS.....	III
APPENDIX 3: PUBLICATION 1, TITLE-PAGE	IV
APPENDIX 4: PUBLICATION 2, SUBMISSION	V
ABBREVIATIONS	VI

INSTRUMENTS	VIII
SOFTWARES & CHEMICALS	XI
CHEMICALS	XII
PUBLISHED DATA.....	II
PUBLICATIONS	III
POSTERS.....	III
PATENT	III
CURRICULUM VITAE	IV
PERSONAL DATA.....	V
EDUCATION.....	V
FELLOWSHIPS	VI
TRAINING COURSES.....	VI

Abstract

Hepatocellular carcinoma (HCC) is the third leading cause of cancer death in the U.S. Notably, most HCCs display c-Myc hyperactivity but this transcription factor participates in the regulation of as many as 15-20% of genes of the entire human genome. To better understand its oncogenic activity, a mass spectrometry-based proteomic approach was employed to search for disease regulated proteins in HCC.

Specifically, the first part of the thesis describes a simple and reliable protocol for serum proteome analysis that combines an optimized resolution of 2-D gels spots and improved sample-matrix preparations for MALDIMS analysis was developed. The protocol allowed automated data acquisition for both CHCA and DHB and simplified the MS data acquisition therefore avoiding time-consuming procedures. The simplicity and reliability of the developed protocol may be applied universally. Specifically, in the present work an integrated serum and tissue proteomic approach was applied to a c-Myc transgenic mouse model that specifically developed HCC. By use of the α -1 antitrypsin promoter, targeted overexpression of c-Myc to the liver was achieved as originally reported by Dalemans *et al.*

In the second part of the thesis, a total of 90 differentially expressed proteins in HCC of c-Myc transgenic disease model were identified with retinol binding protein 4, transthyretin, major urinary protein family, apolipoprotein E and glutathione peroxidase being regulated in common in tissue and serum of HCC mice.

Moreover, this study identified n=22 novel tumor regulated proteins that could be traced back to either cell cycle regulation and proliferation, nucleotide biosynthesis & DNA metabolism, as well as regulation of ribosomal proteins. In this regard, bioinformatics revealed the coding sequences of regulated proteins to be either direct or indirect targets of c-Myc.

Translation of the findings to human disease was achieved by Western immunoblotting of serum proteins and by immunohistochemistry of human HCC.

This study therefore helps to define a c-Myc proteome suitable for diagnostic and possible therapeutic intervention strategies.

In the third part of the thesis, research focused on the glycosylphosphatidylinositol-specific phospholipase D (GPI-PLD) protein. Specifically, to better understand the role of c-Myc in the regulation of GPI-anchored proteins gene expression, Western blotting of regulated proteins as well as enzyme activity of GPI-PLD was investigated in sera of transgenic mice and human HCC. Since the expression and activity of GPI-PLD was also elevated in sera of patients diagnosed with HCC and non-alcoholic steatohepatitis, transcriptional regulation of GPI-anchored proteins in cultures of human hepatocytes under conditions of NASH was investigated as well. Here gene expression data evidenced down-regulation of 25 and 9 GPI-anchored coding genes in mouse HCC and human hepatocyte cultures, respectively, most of which presented E-box motifs in the promoter of regulated genes. Thus, a link between c-Myc activity and modulation of transcriptional response of targeted genes can be proposed. Furthermore, the findings of the present study are highly suggestive for the GPI-PLD to stabilize the c-Myc protein and that induction of the lipoprotein ApoE and PON1 facilitate sustained activity of GPI-PLD to foster survival signalling in malignancy. With human HCC induction and activity of GPI-PLD depended on the complexity of disease and was most pronounced in patients diagnosed with NASH and diabetes mellitus while activity was reduced in alcoholic steatohepatitis.

Taken collectively, this study evidences a novel role of GPI-PLD in liver cancer and modulation of other GPI-anchored proteins by c-Myc.

Keywords: *hepatocellular carcinoma, c-Myc, proteomics, biomarkers.*

Kurzzusammenfassung

Das hepatozelluläre Karzinom (HCC) ist die dritthäufigste Todesursache bei Krebspatienten in den USA. Häufig wird in HCCs eine c-Myc-Hyperaktivität beobachtet. Das Ziel der Doktorarbeit war deshalb spezifische Biomarker für die Diagnostik von HCC und deren Regulation in Tumorgewebe zu finden. Hierzu wurde ein c-Myc transgenes Maus Model untersucht.

Im ersten Abschnitt der Doktorarbeit wurde zunächst ein einfaches und zuverlässiges Protokoll zur Serumproteomanalyse entwickelt, das zugleich eine optimierte Auflösung von 2-D-Gel-Spots und Verbesserungen bei der Aufbereitung der Probenmatrix für die MALDI MS-Analyse bietet. Durch Entwickeln einer automatisierten Datenerhebung sowohl für CHCA als auch DHB Matrix-Protein gemischen konnte die aufwendige massenspektrometrische Datenerhebung vereinfacht werden, so dass mit hoher Zuverlässigkeit eine Identifizierung von Proteinen erfolgen konnte.

Im zweiten Abschnitt der Doktorarbeit wurden nach differentiell exprimierte Proteinen des HCC gesucht. Insgesamt konnten 90 differentiell exprimierte Proteine identifiziert werden, wobei Retinol-Binding-Protein 4, Transthyretin, die Major-Urinary-Protein-Familie, Apolipoprotein E und Glutathionperoxidase sowohl im Gewebe als auch im Serum von Tumormäusen gemeinsam reguliert waren.

Es wurden 22 bisweilen unbekannte tumorregulierte Proteine identifiziert, die an der Regulation des Zellzyklus, in der Zellproliferation, der Biosynthese von Nukleotiden und dem DNA-Stoffwechsel bzw der Regulation ribosomaler Proteine beteiligt sind.

Anhand Western-Immunblotting und durch immunhistochemische Färbungen konnte zahlreiche Ergebnisse für das menschliche HCC übertragen werden.

Im dritten Abschnitt der Doktorarbeit wurde die Aktivität des Glykosylphosphatidylinositol-spezifischen Phospholipase D (GPI-PLD) untersucht. Mit Hilfe von Genexpression Analysen, Western-Blots sowie Bestimmung der Enzymaktivität konnte die Regulation insbesondere in Patienten mit HCC und nicht-alkoholische Steatohepatitis (NASH) gezeigt werden. Darüber hinaus wurde die differenzielle Regulation weiterer GPI-verankerter Proteine in HCC und Kulturen menschlicher Leberzellen unter NASH-Bedingungen untersucht, so dass ein Zusammenhang zwischen c-Myc-Aktivität und den transkriptionellen Antwort der betroffenen Gene gezeigt werden konnte. Insgesamt liefert diese Studie Beweise für eine bislang unbekannte Rolle von GPI-PLD bei Leberkrebs und eine Modulierung anderer GPI-verankerter Proteine durch c-Myc.

Schlagwörter: hepatozelluläre Karzinom, c-Myc, Proteomik, Biomarker

Introduction

Hyperactivity of c-Myc is frequently observed in human cancers as has been evidenced for hepatocellular carcinoma (HCC).

Indeed, HCC is on the rise and estimated to be the fifth most common cause of cancer and the third leading cause of cancer related deaths more in men than women [Jemal,A et.al., 2008].

While early detection of hepatocellular carcinoma significantly improves survival and prognosis, it is a finding by chance as most patients are asymptomatic until the disease has progressed considerably. As of today only a few serum biomarkers are used for disease diagnosis and therapeutic-monitoring and primarily include alpha-fetoprotein (AFP) [Durazo,FA et.al., 2008]. Unfortunately, serum AFP levels are within normal range in about 40 percent of patients with hepatocellular carcinoma of less than 2 cm in diameter while in patients with tumors of 2 to 5 cm in diameter nearly 30% have normal AFP serum levels [Giannelli,G et.al., 2006, Zinkin,NT et.al., 2008]. Moreover, not all hepatocellular carcinomas secrete AFP. Finally, AFP was shown to be elevated in pregnancy, by other tumors of gonadal origin and in acute or chronic viral hepatitis without a tumor [Robinson,L et.al., 1989, Xuan,SY et.al., 2007].

The work described in this thesis aims to identify candidate biomarkers for HCC. For this purpose, a c-Myc mouse model, which specifically develops HCC, was investigated in detail using a modified method in proteome research. As shown in the first part of the *Results and Discussion* section, an improved method for the detection of serum proteins was used, while in the second part of this thesis, novel tissue and serum biomarkers of HCC could be identified. The work has been complemented by gene expression studies and further validation by Western immunoblotting and immunohistochemistry. Importantly, the relevance of the animal findings was assessed in human HCC to further validate the importance of the newly identified disease regulated proteins. In the third and final part of this thesis, regulation of GPI-phospholipase D (GPI-PLD) activity was studied in detail and in relation to other GPI-anchored proteins with the aim to link c-Myc hyperactivity with aberrant signalling activity by GPI-PLD.

Overall, a total of 28 different proteins are novel and reported for the first time in HCC. Knowledge on the activity of these proteins will help to define new biomarkers of HCC and possible represent therapeutic targets in intervention strategies.

Theory

The role of Myc transcription factor in normal biology and cancer



Figure 1. *The Statue of Janus (Janus - Roman God of Gates & Doors, Wilstar.com)*

A paradox for cancer biology is represented by the fact that some oncogenes, such as *c-myc*, provide an advantage to cancer cells by stimulating uncontrolled proliferation while, at the same time, they exert a pro-apoptotic activity.

For that reason, *c-myc* has recently been portrayed as *Janus*, the old Roman deity with two faces who presides over everything, by regulating cell proliferation and cell death [Supino et al. 2004].

More than 20 years ago, Myc was originally defined as an oncogene (*v-myc*) transduced by a number of avian retroviruses capable of potently inducing neoplastic disease [Dellafavera, R et al., 1982]. Subsequently *c-myc*, the cellular homolog of *v-myc*, was identified and eventually shown to be a member of a family of proto-oncogenes comprising *c-myc*, *N-myc*, and *L-myc* [Vennstrom, B et al., 1982].

The c-Myc protein may be O-linked glycosylated and phosphorylated, and those post-translational modifications may alter its half-life. The c-Myc sequence contains several conserved N-terminal domains, termed Myc boxes, which are found to be in closely related Myc proteins, N-Myc and L-Myc (**Figure 2**).

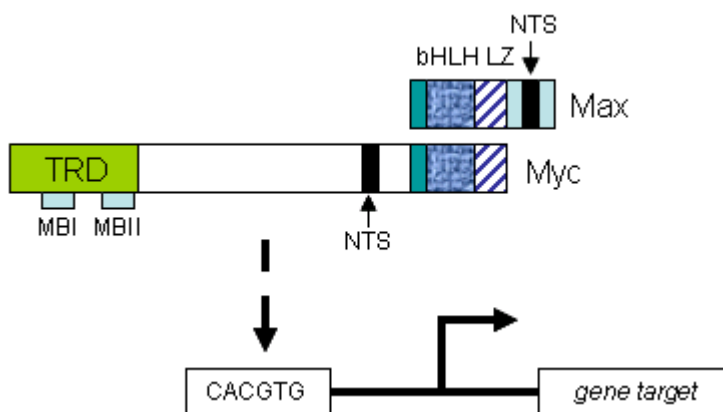

NTS: Nuclear Targeting Signal

bHLH LZ: basic region/helix-loop-helix/leucine zipper domain

MBI/MBII: Myc boxes or conserved sequences among Myc protein family

TRD: TransRegulatory Domain

Figure 2: Scheme of specific N- and C-terminal sequences on Myc gene. The N-terminal presents Myc boxes domains (MBI and MBII), whilst C-terminal is characterized by the helix-loop-helix zipper domain, important for the heterodimerization Myc-Max.

The Myc proteins encoded by myc family genes are predominantly localized in the cell nucleus and their expression generally correlates with cell proliferation.

At the C-terminal region, c-Myc contains a dimerization motif, termed basic region/helix-loop-helix/leucine zipper domain (bHLHZip). The Myc dimerization provides its role as transcriptional activator. Specifically, Myc protein homodimerization (Myc-Myc) have been reported as unstable and to bind DNA in a non-efficient manner [Soucek, L *et al.*, 2002]. In 1991, the bHLHZip protein Max was identified as a c-Myc obligate partner (Myc-Max) allowed instead a stable DNA binding by its evolutionary conserved bHLHZip at the protein's COOH terminus. Max was shown to interact specifically with all Myc family proteins, and the resulting heterocomplexes recognize the hexameric DNA sequence CACGTG (belonging to the larger class of sequences known as *E-boxes*, CANNTG) at concentrations at which binding by either partner alone is undetectable [Blackwood, EM *et al.*, 1991, Prendergast, GC *et al.*, 1991].

Importantly, Myc requires Max to act on genes containing canonical or non-canonical E-box binding sites [Amati,B *et al.*, 1992]. DNA-bound Myc-Max complexes activate transcription through the amino terminal 143 amino acids of c-Myc, termed the transcriptional activation domain (TAD).

Transcriptional activation by c-Myc involves the recruitment of histone acetyltransferases and other coactivators [McMahon,SB *et al.*, 2000]. These enzymes modify the chromatin surrounding c-Myc target gene loci, thereby facilitating increased transcription.

In contrast, transcriptional repression by c-Myc appears to involve multiple, distinct mechanisms [Gartel,AL *et al.*, 2003, Kleine-Kohlbrecher,D *et al.*, 2006]. At the biochemical level, the best characterized of these mechanisms depends on c-Myc binding and inhibiting the activity of the transcriptional activator Miz-1 (Myc-interacting zinc-finger protein-1) [Facchini,LM *et al.*, 1998, Patel,JH *et al.*, 2006]. In the absence of c-Myc, Miz-1 binds to specific genes and activates their transcription [Liu,Q *et al.*, 2010]. When over-expressed, c-Myc binds directly to Miz-1 and blocks this transcription (**Figure 3**) [Li,LH *et al.*, 1994].

Finally, the N-terminal transregulatory domain (TRD) of c-Myc is required for cell transformation and that likely both its activation and repression functions are required for neoplastic transformation.

Gene target activation

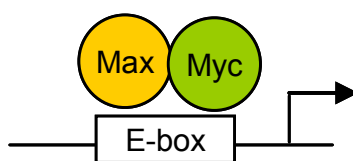

Gene target suppression

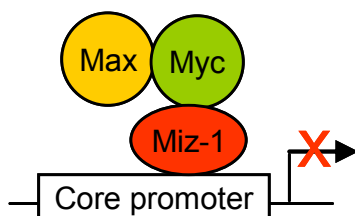

Figure 3: Scheme of gene target regulation by Max and Miz-1 heterodimers of c-Myc.

Myc biological functions

The continuous and intense scrutiny with which *myc* has been still studied after its discovery derives mainly from its involvement in a wide range of cellular proliferation, differentiation and tumorigenesis [Larsson, LG et al., 2010]. The initiation or stimulation of tumor formation is obviously not the normal function of Myc proteins but a reflection of its ability to stimulate cell cycle progression. Indeed, expression of *c-myc* in normal cells is regulated by external (such as growth factors) and by internal signals (cell cycle) [Pelengaris, S et al., 2003]. Cellular abnormal or ectopic over-expression of *c-myc* activates protective pathways, such as p19/p14ARF and a p53-dependent cell death, hence eliminating those cells [Felsher, DW et al., 1999]. In contrast, ligands such as transforming factor beta and gamma interferon, can even cause rapid down-regulation of *c-myc* expression [Pietenpol, JA et al., 1990, Ramana, CV et al., 2000].

The expression of Myc genes and proteins are strictly controlled at multiple levels. The *c-myc* gene is expressed during all stages of the cell cycle in dividing cells and is normally down-regulated during differentiation. Its expression is induced by various mitogenic signalling pathways, such as Wnt, Notch and STAT. Myc proteins, however, are turned over at a very high rate via ubiquitin/proteasome pathways, in a complex mechanism (**Figure 4**) [Adhikary, S et al., 2005, Schulein, C et al., 2009].

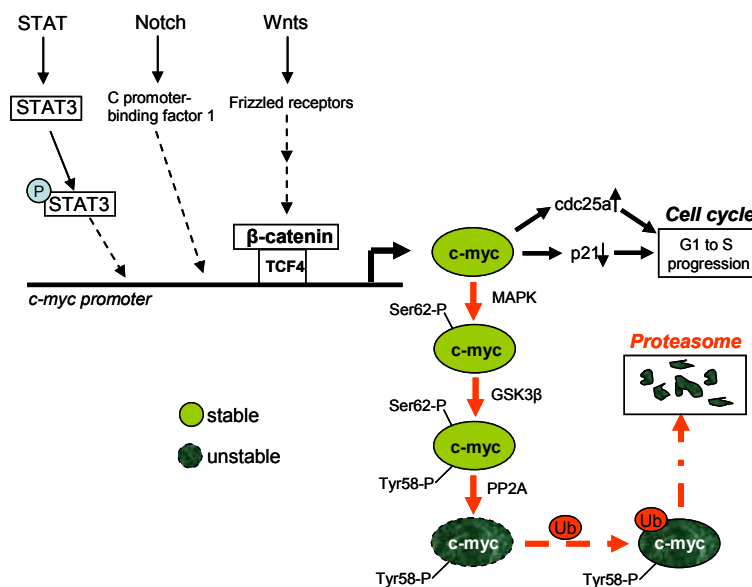

Figure 4: Scheme of activation of *c-myc* gene by STAT, Notch and Wnt. In particular, the β -catenin acts in conjunction with the transcription factor TCF4 to activate the *c-myc* gene target.

In red is highlighted the degradation of c-Myc protein through ubiquitin/proteasome pathway (MAPK: Mitogen-Activated Protein Kinase; GSK3 β : Glycogen Synthase Kinase 3 β ; PP2A: Protein Phosphatase 2A)

Myc and cancer

The findings that human cancers frequently display altered expression of human *c-myc* underscore the importance of this gene in the cause of human cancers.

Indeed, the ability of over-expressed c-Myc to facilitate proliferation and inhibit terminal differentiation fits well with the fact that tumors of diverse origins contain genetic rearrangements involving *myc* family genes. For instance, increased *c-myc* gene transcription may account for the observed elevation of Myc in human colon carcinoma [Arango,D *et.al.*, 2003, Santi,V *et.al.*, 2007]. Moreover, since the co-activator beta-catenin might activate *myc* expression through TCF4 transcription factor, it is not surprising that activated beta-catenin proteins have been found in liver, colon and other cancers with concomitant Myc deregulation [van de Wetering,M *et.al.*, 2002].

In addition, *ras* oncogene appears to stabilize the c-Myc protein through a putative post-translational mechanism [Kerkhoff,E *et.al.*, 1998, Sears,R *et.al.*, 1999].

In the 1980s Weinberg and co-workers demonstrated that rat embryo cells were transformed by *c-myc/ras* co-transfection [Land,H *et.al.*, 1986]. Further studies on animal models showed that tissue-targeted expression of *c-myc* leads to tumor in those targeted tissues [Arvanitis,C *et.al.*, 2005].

Although a link between *c-myc* and cancer is well established both *in vivo* and *in vitro*, the molecular mechanisms of *c-myc*-mediated transformation are not fully known.

Recently, a role of c-Myc in cell cycle progression, metabolism, apoptosis and genomic instability has been reported.

Most studies have focused on the effect of c-Myc on regulatory proteins of the G1-S phase transition of the cell cycle. c-Myc has been implicated in inducing cyclin D1 and D2, cyclin E, CDK4 and *cdc25A* (Figure 5).

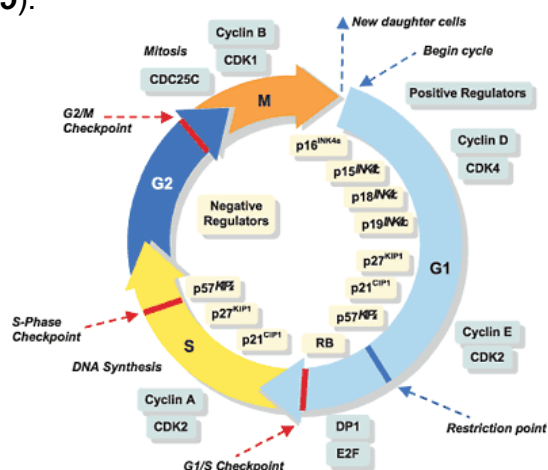

Figure 5: The check-points of c-Myc in the cell cycle

Moreover, c-Myc may provoke genome instability through cell cycle proliferation [Anderson,GR, 2001]. The term *genome instability* refers to genetic changes (i.e. point mutations, deletions, duplications, amplifications, translocations, inversions and aneuploidy) that affect the normal organization and function of genes and chromosomes.

Finally, some studies suggested that c-Myc may induce reactive oxygen species (ROS) production by mitochondria and consequently, DNA damage and genomic instability [Vafa,O et.al., 2002].

High capacity proliferation requires increased energy supply and availability of molecular substrates to meet the demand for increased cellular activity.

According to the Warburg effect, malignant cell growth is caused by the strategy that tumor cells use to generate energy mainly by glycolysis [Warburg, 1956]. This is in contrast to "healthy" cells which mainly generate energy from oxidative breakdown of pyruvate (Krebs cycle). Then, following his hypothesis, cancer may be considered a mitochondrial dysfunction.

After more than 50 years of the Warburg theory, in term of propensity of the cancer to take up glucose avidly and convert it in lactate (aerobic glycolysis), novel hypothesis have been suggested recently.

Up to now, the high glucose uptake has been documented by positron emission topography (PET) scanning of human cancers with radiolabeled 2-deoxyglucose [Chen,X et.al., 2008, Larson,SM, 2004].

The doubts were fuelled by the evidence that not all cancers are PET-positives. To this end, a "rethinking" about the Warburg hypothesis has been suggested recently by Dang (**Figure 6**) [Dang,CV, 2010]. According to his review based on recently published evidences, an alternative energy and anabolic source of carbon and nitrogen for nucleotide biosynthesis is glutamine, an amino acid highly present in human blood. Additionally, previous studies were carried on mainly *in vitro*, condition with which is difficult to encompass the high capability of tumor cells to adapt and tolerate hypoxia. Indeed, tumor tissues are generally hypoxic with some sporadic oxygenated areas. Commensally relations among cancer tissue areas and other evidences which have shown hypotoxic tumor cells producing lactate, let to think a symbiotic mechanism including mitochondrial biogenesis, oxygen consumption, and glycolysis; in that, Myc seems to drive both aerobic glycolysis and oxidative

phosphorylation [Dang,CV *et.al.*, 1999b, Dang,CV *et.al.*, 2008]. When the oxygen is limited in cancer tissue, deregulation of c-Myc plays an important role in collaboration with the hypoxia-inducible factor 1 (HIF-1) in decreasing mitochondrial respiration. However, it does not mean that other functions of mitochondria must be unpaired, such as their biosynthetic functions. An independent discovery by the Thompson laboratory that c-Myc stimulates glutamine metabolism, makes this hypothesis more concrete [Wise,DR *et.al.*, 2008].

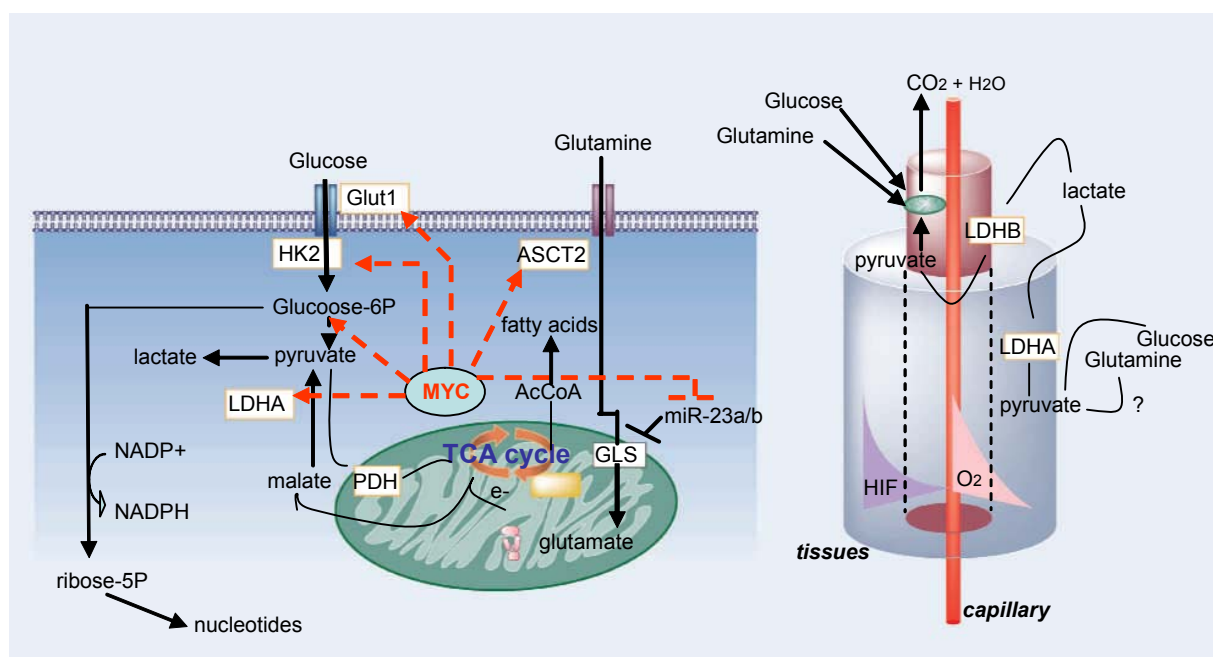

Figure 6: Rearranged scheme from Dang C.V, *Cancer Research* 2010. The boxes evidence the c-Myc targets

In this regard, the “re-thinking” model may explain the role of Myc in increasing mitochondrial biogenesis and glutamine metabolism for ATP production, anabolic carbon and nitrogen sources, in oxygenated tissues, and, in increasing glucose flux, which provides anabolic carbons for ribose and fatty acid biosynthesis.

Protein production is driven by protein translation and relies on ribosomal biogenesis, globally essential for cell growth and proliferation. Deregulation of these sophisticated cellular processes leads to abnormal homeostasis and carcinogenesis. MYC has also been shown to serve as a direct regulator of ribosome biogenesis [Oskarsson,T *et.al.*, 2005, van Riggelen,J *et.al.*, 2010]. It is a key function in stimulating transcription of a number of genes encoding proteins essential for

ribosomal biogenesis and protein translation, including ribosomal proteins. It is debating whether this increase in ribosomal biogenesis is merely the consequences/side effects of cancer transformation or whether an active role in cell transformation (**Figure 7**).

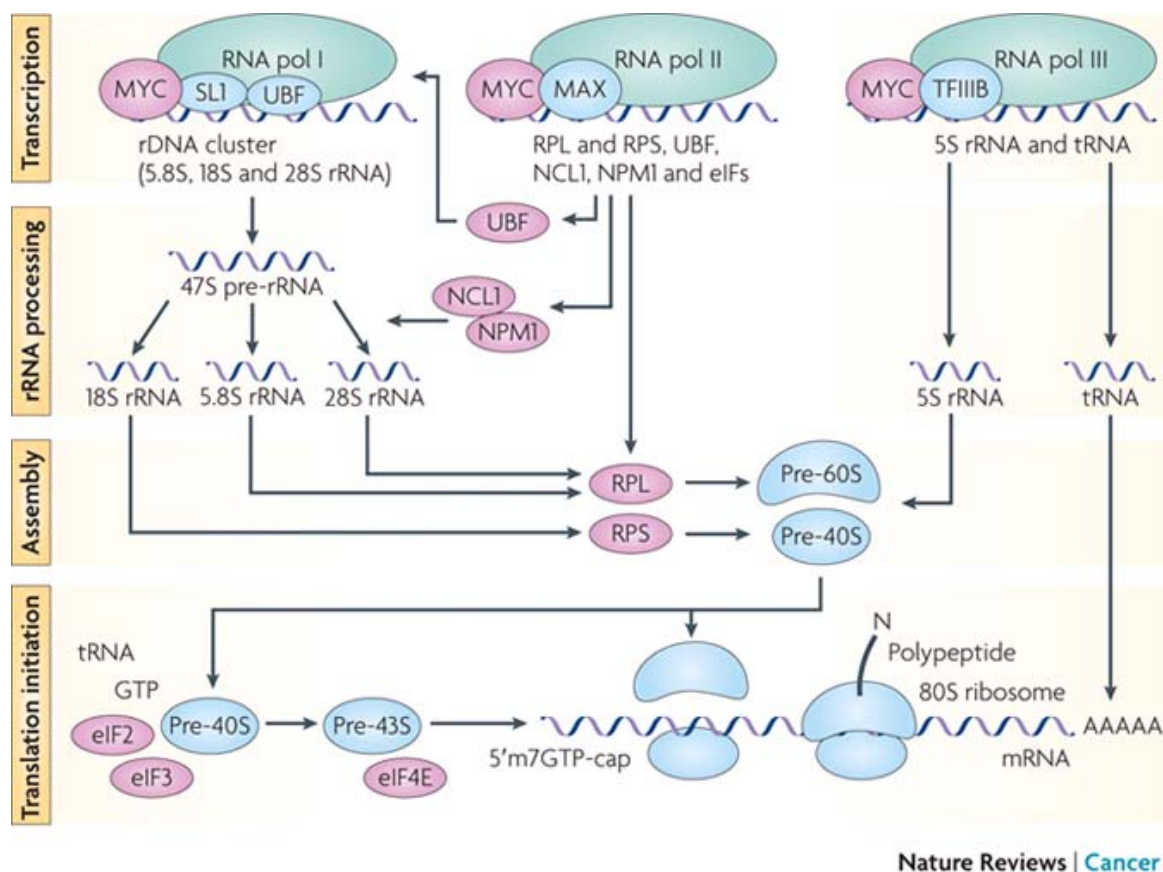

Figure 7: MYC–MAX stimulates the transcription of protein components in an RNA pol II-dependent manner. This includes proteins of the small ribosomal subunit (RPS) and large ribosomal subunit (RPL), nucleolin (NCL) and nucleophosmin (NPM1), which are involved in rRNA processing and export, UBF that serves as a cofactor for RNA pol I-dependent transcription as well as eukaryotic initiation factors that control the initiation of translation. TFIIIB, transcription factor IIIB. *Nature Reviews* 2010

The understanding of Myc's role as an oncogenic switch has evolved through various paradigm shifts over the past two decades but still is not completely understood. However, deregulation of c-Myc is reported in various cancers, including 50% of human HCCs.

Hepatocellular carcinoma

Hepatocellular carcinoma (HCC) is the third leading cause of cancer death in the U.S and 11.3% of cancer mortality worldwide (**Figure 8**).

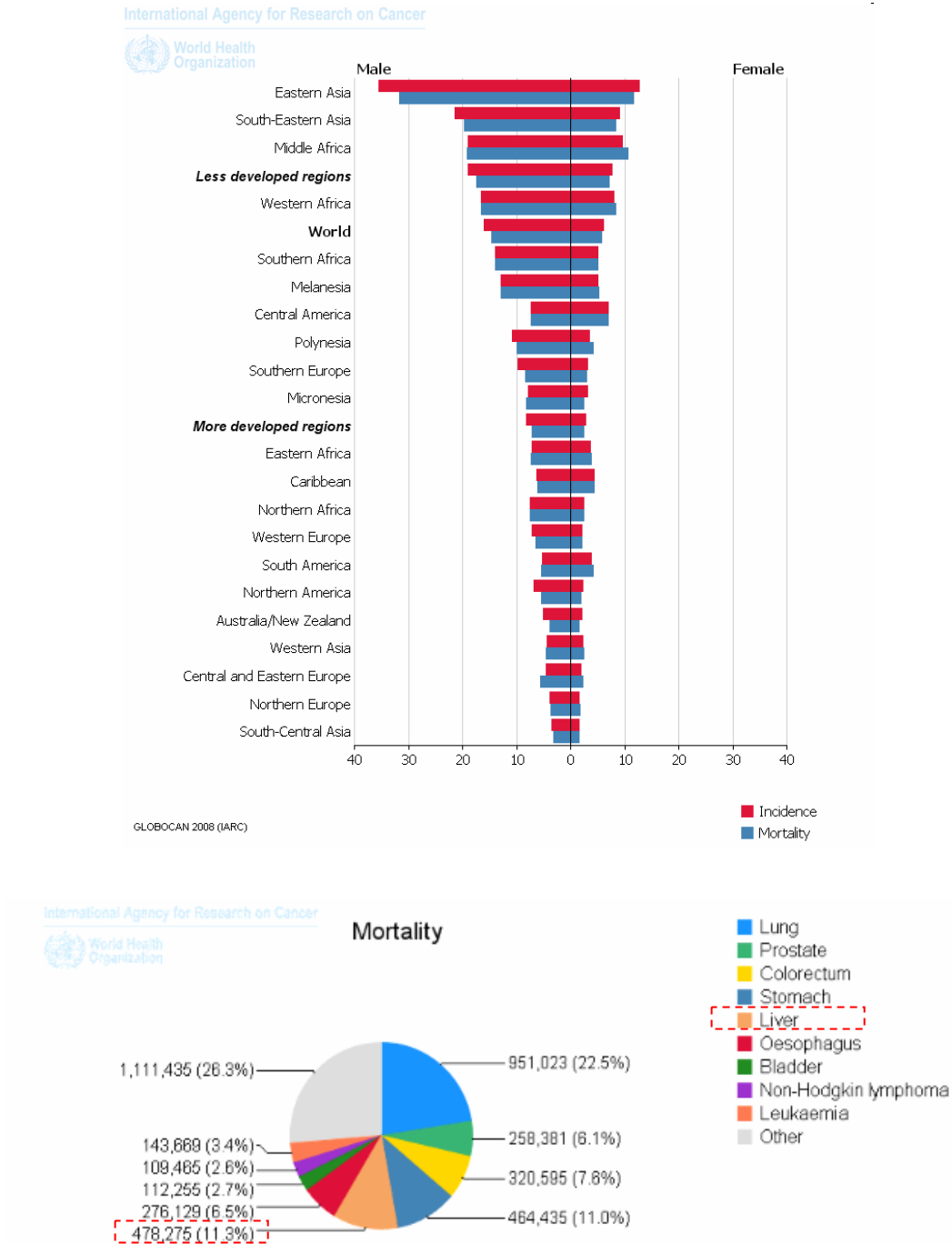

Figure 8: Font "Liver Cancer Incidence and Mortality Worldwide in 2008, GLOBOCAN"

In most cases, the cause of liver cancer is usually scarring of the liver (cirrhosis). Cirrhosis may be caused by alcohol abuse (the most common cause in the United States), certain autoimmune diseases of the liver, diseases that cause long-term inflammation of the liver, aflatoxin B1 (mycotoxins found in stored food), chronic hepatitis B or C virus infection or hemochromatosis (abnormal amount of iron in the body) (**Figure 9**).

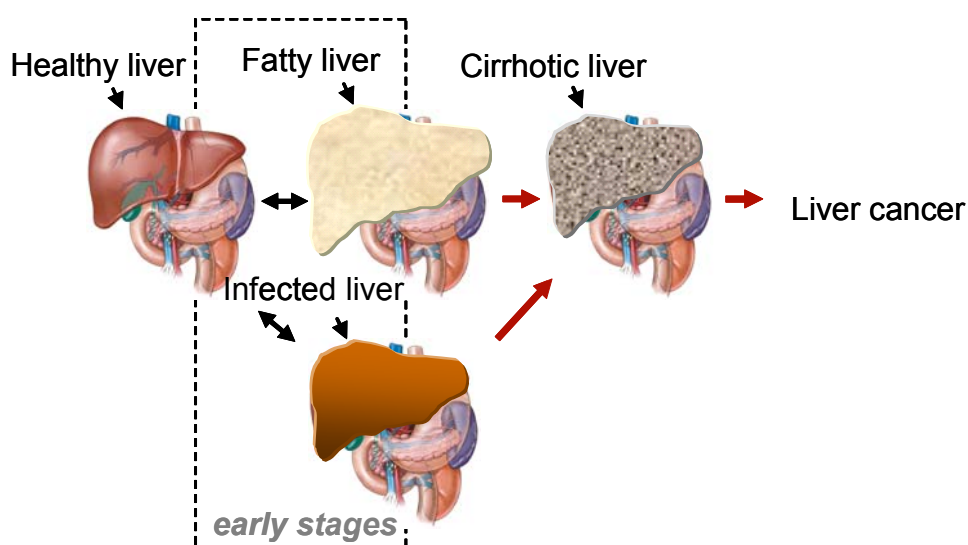

Figure 9: Early stages of liver cancer. Alcoholic and non-alcoholic steatohepatitis or chronic viral infection (HBV/HCV viruses) are the most common causes of cirrhotic liver, an irreversible stage of liver disease which leads to primary liver cancer. Other causes of liver malignancy are aflatoxins, haemochromatosis as well as diabetes.

Diagnosis of HCC

Unfortunately, diagnosis of the hepatocellular carcinoma occurs at the last stages of the malignancy, since symptoms at the early stages, whether any, are generally not specific and they do not conduct clearly to liver malignancy (fever, feeling of fullness, weight loss, easy bruising or bleeding, enlarged abdomen, yellow skin or eyes – jaundice-).

Clinically, invasive techniques (such as biopsy or liver scan) are used to monitor liver cancer but are of limited value due to the heterogeneity of disease.

Treatment of HCC

Cryotherapy, radiofrequency ablation and hepatic artery embolization all are techniques for debulking unresectable tumors (mainly liver metastasis) in order to decrease tumor burden and to treat the carcinoid syndrome. Effective debulking can improve the carcinoid syndrome and also prolong survival. Probes that freeze (cryotherapy) or deliver radiofrequency waves (RF ablation) can be inserted into the liver to debulk the liver of metastases from carcinoid tumors.

Hepatic artery embolization involves blocking the arterial blood supply to carcinoid tumors (using oil-gelatin sponge particles) in the liver followed by chemotherapy to debulk the remaining the liver tumors. Alternatively, radioactive microspheres can be injected into hepatic arteries to kill the liver tumors.

Even novel targeted medicines are monitored for non-invasive treatment of the hepatocellular carcinoma, such as sorafenib (*Nexavar*®, Bayer), the survival rate of patients after diagnosis does not overcome the 5% at 5 years (**Figure 10**).

Sorafenib is a multi-tyrosine kinase inhibitor drug which has been approved for treatment of advanced primary liver cancer.

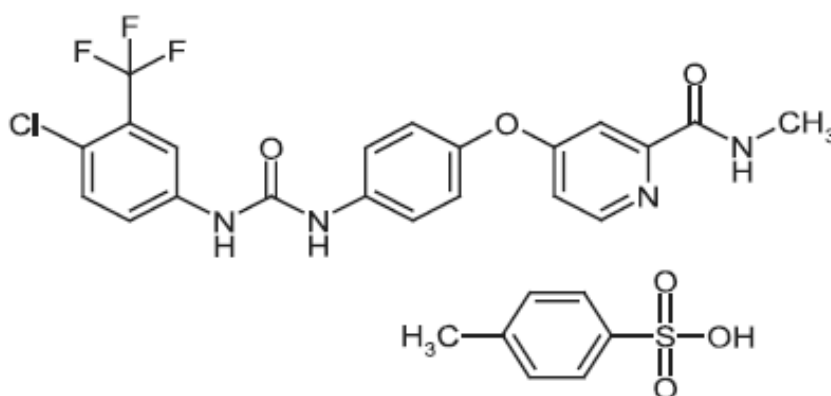

Figure 10: Structure of sorafenib

It has shown a 44% improvement in patients who received sorafenib compared to placebo (hazard ratio 0.69; 95% CI, 0.55 to 0.87; $p=0.0001$). However, it is not without side effects, such as skin rash, hand-foot skin reactions, diarrhea,

hypertension and development of reversible posterior leukoencephalopathy syndrome and reversible erythrocytosis [Alexandrescu,DT et.al., 2008] and some countries, such as U.K., have declined to approve the drug, since the effectiveness does not justify the high price -at up to 3600 Euro per patient per month!-

The role of c-Myc in HCC

Most HCCs over-express c-Myc transcription factor that may participate in the regulation of as many as 15% of genes of the human genome.

At the molecular level, genetic analyses had revealed that c-Myc is frequently over-expressed, i.e. in up to 70% of human viral and alcohol-related HCC [Schlaeger,C et.al., 2008] and high throughput tissue microarray analysis had clearly demonstrated c-Myc as an important driver in HCC and chronic liver diseases [Chan,KL et.al., 2004]. Moreover, studies on hepatitis B virus infected HCC patients had revealed a strong activation of MYC gene by HBx while activation of c-Myc accelerates the HBx oncogenic potential, resulting in a central role of c-Myc in HCC promotion and progression.

Given the importance of c-Myc in HCC carcinogenesis, it is not surprising that it is an attractive target for novel therapies, as recently reviewed [Larsson,LG et.al., 2010].

Biomarkers for HCC

Since the liver can not tolerate doses of radiation and the disease is not responsive to chemotherapy, immunotherapy, biological therapy, and gene therapy techniques are being tested, and the scientific community is working hardly to search for markers which can be easily detected and specifically recognised at early stages of HCC.

According to the official NIH definition, a biomarker is "a characteristic that is objectively measured and evaluated as an indicator of normal biologic processes, pathogenic processes, or pharmacologic responses to a therapeutic intervention".

Search for those "characteristics" are carried on generally in bio fluids, such as plasma, serum or urine. Indeed, general blood and urine analyses are not invasive and they are well-tolerated from patients.

Up to now, few serum biomarkers are used in clinical trials for detecting HCC, such as alpha-fetoprotein (AFP) [Durazo,FA et.al., 2008].

AFP is a glycoprotein of 591 amino acids and a carbohydrate moiety. The human fetus has the highest amount of AFP levels found in humans. These AFP levels

gradually decrease after birth down to the low, but detectable levels found in adults by the time a newborn reaches 8 to 12 months. AFP has no known function in healthy adults. However, this protein has been reported as high concentrated in serum of HCC patients. At the clinical level, the protein is still analysed for HCC detection, but its low specificity and sensitivity has doubted its efficiency as HCC biomarker. Moreover, serum AFP levels are reported within normal range in about 40 percent of patients with hepatocellular carcinoma of less than 2 cm in diameter while in patients with tumors of 2 to 5 cm in diameter nearly 30% have normal AFP serum levels. Thus, it is excluded for early detection of HCC. Finally, not all hepatocellular carcinomas secrete AFP. For instance the AFP was shown to be elevated in pregnancy, by other tumors of gonadal origin and in acute or chronic viral hepatitis without a tumor [Castelli,A, 2009, Sherman,M, 2001].

Other serum candidate biomarkers for HCC are object of study and they were recently evaluated for their clinical utility that included a comparison of AFP-L3 and des-gamma- carboxy prothrombin (DCP) with DCP being a more robust and reliable marker as reported elsewhere [Durazo,FA et.al., 2008]. Other candidates were also suggested that function in metabolism, calcium homeostasis, cytoskeleton dynamics tumor suppression, and apoptosis. Owing to the complexity of the disease such candidate biomarkers need to be validated for specificity and usefulness in the diagnosis and the monitoring of disease progression.

Animal models of HCC

The drawback in searching for specific candidate biomarkers in human beings is mainly the high variability among different patients. To overcome this problem, biomedical researchers use animal models, such as mice or rats.

The research involves a long-term objective, such as developing a new drug for diabetics, screening a particular compound for human toxicity, studying a gene or mutation found in both animals and humans or studying a fundamental process such as gene transcription. The short-term objective is to use the animal model in experiments to determine how it responds to the treatments. If it is a faithful model of humans, then humans should respond in the same way. Animal models are used because the research can not be done on humans for practical or ethical reasons.

Hepatocellular carcinoma is a complex malignancy and several transgenic mouse models have been employed to exploit molecular mechanisms behind the promotion and progression of this primary liver cancer (**Table A**).

Among them, there are *implantation models* and *engineered mouse models*.

The *implantation models* are among the most widely used models to accomplish HCC formation in mice, since they are suitable for studies in preclinical evaluation of anticancer agents. The earliest implantation model is the syngeneic transplantable tumor model, in which a HCC cell line or liver tissue fragment is implanted in mice. However, this method is less used now, since it has been overcome by the use of immunodeficient mice which can be implanted with human HCC cell lines, such as HepG2 or Hep3B (xenograft models). The implantation in both cases can be made in an ectopic (subcutaneously) or orthotopic (either by subserosal injection of HCC cells or by surgical orthotopic implantation of liver tumor fragments) manner.

The xenografts of human HCCs are generally used in preclinical evaluation of anticancer agents. However, recent studies have shown that subcutaneous implantation do not always lead to spontaneous metastasis, but they do in orthotopic ones. For that reason ectopic implantations are often validated by orthotopic ones. On the other hand, orthotopic implantations are more difficult and very expensive. Finally, it has been demonstrated that these models have a poor predictive value for the anti-tumor effects in patients, since the cultured cells are maintained for long period and not longer maintained in the original environments.

The introduction of *transgenic mouse models* in the earlier 1980's made it possible to study the molecular features of human malignancies *in vivo* [Palmiter, RD *et al.*, 1982, Shuldiner, AR, 1996].

In particular, the use of genetically *engineered mouse models* (GEM) is of a great importance to understand the role of specific genes in combination with malignancy.

In the development of HCC, different pathways are thought to be involved, even though no exact genetic events in hepatocarcinogenesis are fully clarified.

However, it seems that alterations of p53, Rb and Wnt/ β -catenin pathways are involved during HCC.

Overexpression of *c-myc* and transforming growth factor-alpha (TGF- α) has been frequently observed in human hepatocellular carcinoma (HCC), suggesting a pivotal role played by these protooncogenes in liver oncogenesis [Calvisi, DF *et al.*, 2005b].

Often Myc activation has been associated with chronic viral HCC [Singh, M et al., 2003, Terradillos, O et al., 1997]. These GEM have been useful in understanding genes role in hepatocarcinogenesis.

A c-Myc transgenic mouse model of HCC

The α -1-antitrypsin (AAT) transgenic mouse model was developed in 1990 by Dalemans and co-workers. This HCC mouse model employs the α -1 antitrypsin promoter, thereby targeting overexpression of c-Myc to the liver. [Dalemans, W et al., 1990].

transgene	promoter	mouse strain	references
TGF- α	metallothionein-1	CD1	[Jhappan, C et al., 1990, Lee, GH et al., 1992]
SV40 T-Ag	antithrombin 3	C57BL/6 x DBA2	[Dubois, N et al., 1991]
E2F-1	albumin	C57BL/6 x CBA/J	[Conner, EA et al., 2000]
c-myc/TGF- α	albumin, metallothionein-1	C57BL/6 x CBA/J x CD1	[Thorgeirsson, SS et al., 1996]
c-myc/E2F-1	albumin	C57BL/6 x CBA/J	[Calvisi, DF et al., 2005a]
c-myc	albumin	C57BL/6 x CBA/J	[Thorgeirsson, SS et al., 1996]
c-myc	α 1-antitrypsin	C57BL/6	[Dalemans, W et al., 1990]

TGF- α : transforming growth factor alpha

SV40 T-Ag: simian vacuolating virus 40 TAg

E2F-1: transcription factor E2F1

CD1: albino mice

C57BL76: C57 black 6 mice

CBA/J: CBA substrain, blind mice

DBA2: Dilute Brown Non-Agouti mice

Table A. Here are listed the major mouse models used for the study of hepatocellular carcinoma (HCC).

This transgenic mouse model develops HCC between 8-12 months of life, as confirmed by histopathology (**Figure 11**).

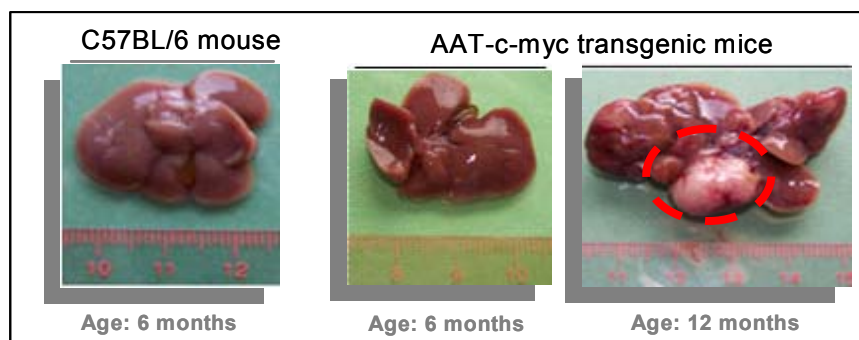

Figure 11: Histology of mouse livers from healthy (C57BL/6) and HCC bearing mice (AAT-c-myc transgenic) at different ages. Macroscopically evidence of HCC was clear only in 12 months aged mice.

Proteomics-based biomarker discovery

The ability of protein biomarkers to provide indications of physiological states or change makes them an important diagnostic and predictive tool in many clinical settings. Since disease processes involve very complex interactions of large numbers of proteins, there is a considerable interest in the technologies and data analysis techniques specially designed to handle this level of complexity, making it possible to study the entire complement of proteins, the “proteome”, of a blood or tissue sample. The simultaneous analysis of many proteins in a single sample may reveal patterns in their presence, abundance and modifications that result in a “protein signature” associated with the presence or absence of disease at a stage when it is otherwise undetectable. The same techniques may also be used to analyse a complex disease process and identify key molecules that could be targets for drug development. Two main strategies are used for protein profiling studies, gel-based and gel-free proteomics, which differ on the use of mono- and two-dimensional gel electrophoresis as separation techniques.

In the gel-based approach the proteins are separated by two dimensional gel electrophoresis (2DE), an established technique since the late 1970s [O'Farrell, 1975], according to their isoelectric point ($pH=pI$) in the first dimension (¹⁻²)

$$pI = (pK_{a1} + pK_{a2}) / 2 \quad (1)$$

$$pK_a = pH + \log \frac{[HA]}{[A^-]} \quad (2)$$

(¹) The isoelectric point (pI) is the pH at which a particular molecule or surface carries no net electrical charge.

(²) Henderson-Hasselbach Equation

and to the molecular mass weight (Mw) in the second dimension (**Figure 12**).

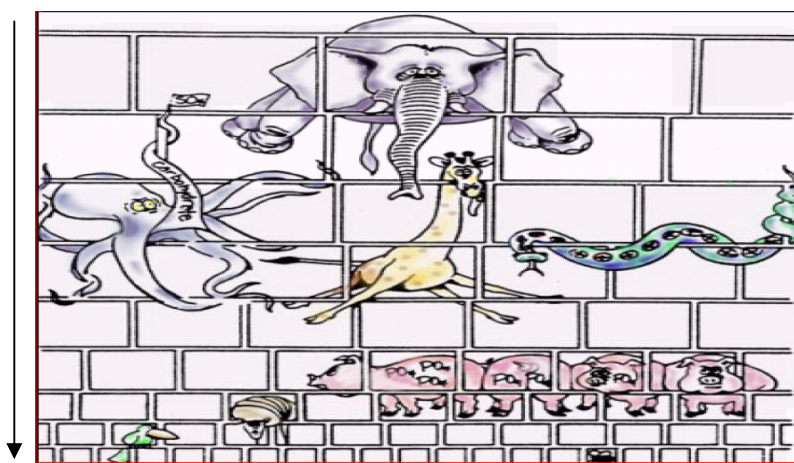

Figure 12: The figure depicts ironically the run of proteins in the second dimension of SDS-PAGE. In particular, it is shown an acrylamide matrix in gradient gels (University of Bologna, Italy).

After the separation, a constellation of protein spots obtained from the different samples can be visualized (**Figure 13**) and compared using appropriate bioinformatics tools, and the differently expressed proteins can be excised, in-gel digested and identified by mass spectrometry [Huang,HL et.al., 2006, Penque,D, 2009, Wulfkuhle,JD et.al., 2003].

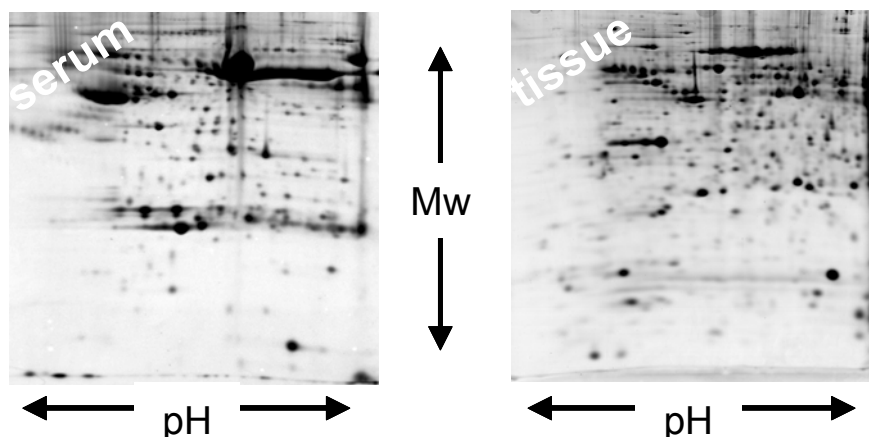

Figure 13: Two-dimensional SDS-PAGE gels at pH 4-7 from mouse serum and tissue extracts.

The *gel-free protein profiling* approaches are based on the study by mass spectrometry of the fingerprint (or protein pattern) of proteins characteristic of a specific sample or biological state [Rocchiccioli, S *et.al.*, 2010]. A typical mass spectrometry protein profiling approach can be performed by enrichment of proteins according to their physical/chemical features followed by MALDI-TOF analysis. The comparison among spectra, one of the critical points of this approach, allows for the evaluation of the proteins differentially expressed which can be identified by MALDI-TOF-TOF analysis or by isolation of the proteins of interest followed by tryptic digestion and MS analysis. The surface-enhanced lasers desorption/ionization (SELDI) TOF MS technology, an extension of MALDI MS, can be also used for these purposes.

Mass spectrometry has been a key part of biomarker discovery for the sensitivity and selectivity in detection, multi-analyte analysis, and for the ability to provide structural information. Nearly 20 years after its introduction to biology research, MS has become a tremendous success [Cravatt, BF *et.al.*, 2007]. It has revolutionized the way in which biological information, especially related to proteins, can be obtained. With time, MS will become a routine technique to tackle a wide variety of biological questions. Due to its ability to acquire high content of information, mass spectrometry has emerged among the proteomic techniques as the method of choice for analysing

the study of the composition, regulation and function of protein complexes in biological systems [Aebersold,R et.al., 2003, Cravatt,BF et.al., 2007, Domon,B et.al., 2006, Yates,JR, 2004]. Mass spectrometers are used either to measure simply the molecular mass of a polypeptide or to determine additional structural features including the amino acid sequence or the site of attachment and type of posttranslational modifications [Domon,B et.al., 2006].

A mass spectrometer can be split into three main parts: the *ionization source* where the gas phase ions are produced from sample molecules, the *mass analyser* where the ion separation occurs and the *mass detector* where the signal is recorded.

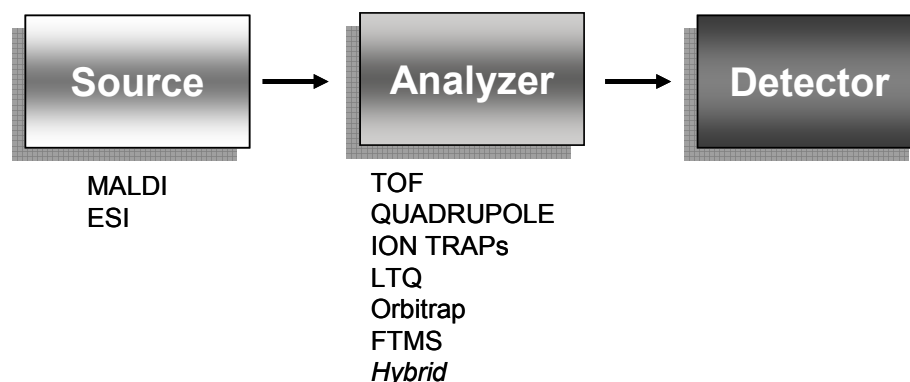

Figure 14: Structure of a mass spectrometer for protein analysis.

Specifically, Matrix-Assisted Laser Desorption/Ionization-mass spectrometry (MALDI-MS) consists in ion generation and desorption of analytes embedded in a solid matrix by using laser irradiation. In MS mode, the ions are all given the same kinetic energy, and the time of flight (TOF) depends on the mass of the analyte. Only fragments formed in source (in-source decay, or ISD) are detectable. In MS/MS mode (**Figure 15**), a LIFT cell is inserted in the ion flight path, which selects a parent ion and its fragments formed after the source (post-source decay, or PSD) on the basis of their flight time in the first TOF region. The parent and fragment ions are then re-accelerated, and therefore travel with different velocities according to their masses, and are focused on the detector after passing through the reflectron.

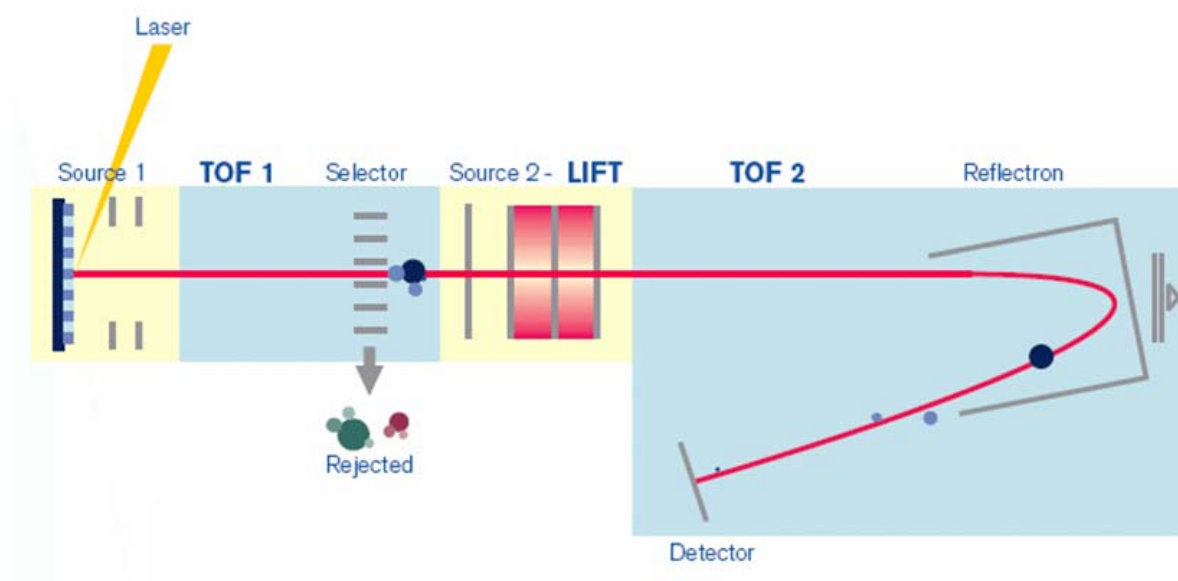
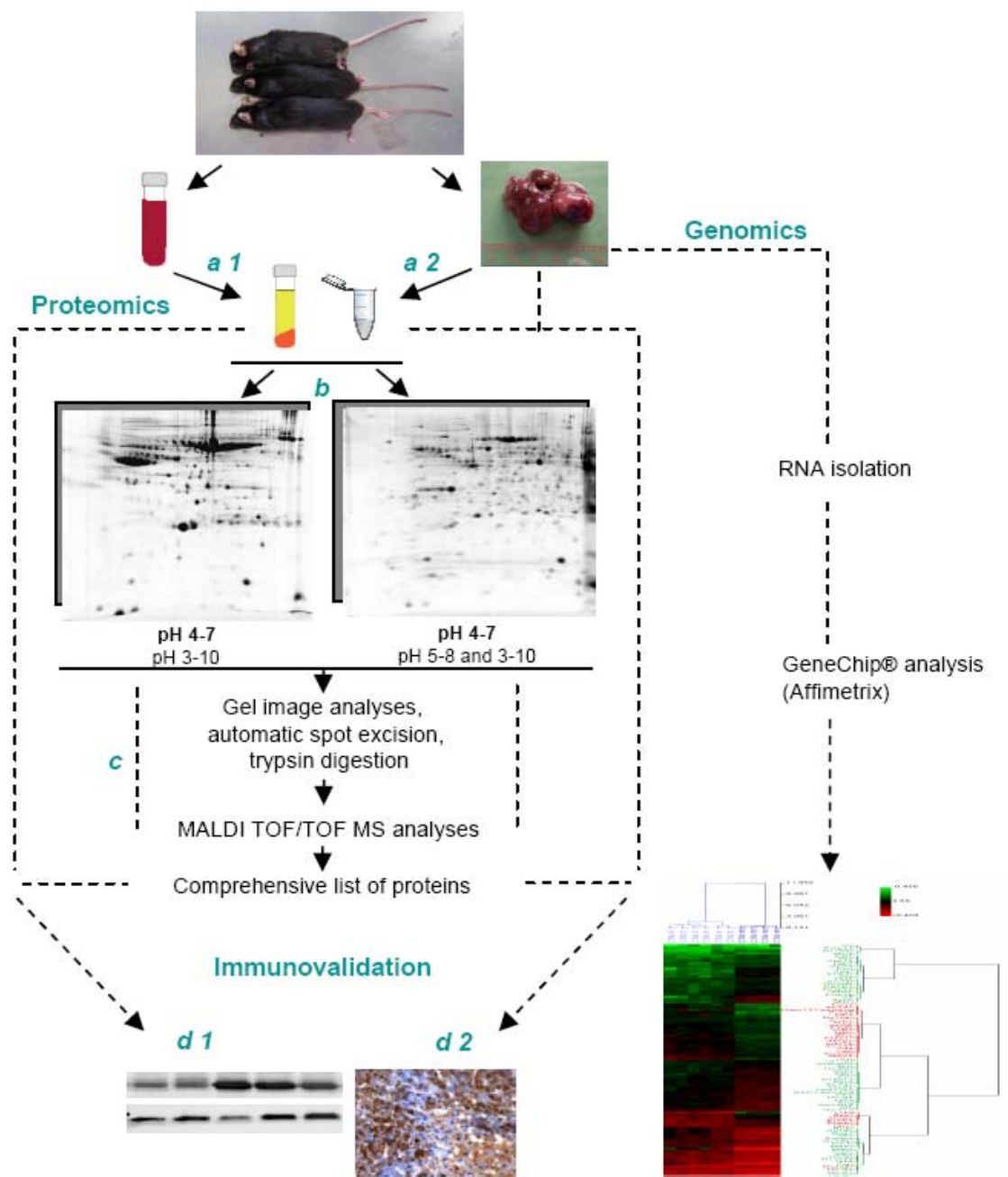

Figure 15: The heart of the ultraflex TOF/TOF system is the LIFT module. This technology has been especially designed to utilize the metastable ions generated by LID (Laser-Induced Decomposition)(Font: Bruker Daltonics Website).

The LIFT™ is a patented technology by Bruker Daltonics which is considered as an high sensitive method to acquire TOF/TOF spectra with high-energy detection of either LID or CID (high-energy Collision-Induced Decomposition). Basically, the fragmented ions are post-accelerated in the LIFT module and detected.

Mass spectrometry (MS) provides a promising strategy for biomarker discovery of HCC and applications of MALDI-TOF MS as an effective technology to profile serum proteome have already been suggested [Beckhaus, T et.al., 2005, Pan, S et.al., 2009]. As shown in **Scheme 1**, a general workflow of serum proteome study was developed, coupled with immune validation and translational research.



Scheme 1: Workflow of the work described in this thesis.

a: extraction of proteins,

b: gel electrophoresis (2-DE),

c: Image analysis and MALDI-MS;

d: immunovallation (d1:WB, d2: Immunohistochemistry)

Aims of the Doctoral Thesis

The aims of the doctoral thesis project can be summarized as follow:

PART 1

- Development of an improved method for serum protein identification
- Map the serum protein of healthy mouse sera

PART 2

- Search for novel serum biomarkers of HCC in the c-myc transgenic mouse model of liver cancer
- Confirm of disease-regulated proteins identified in the c-Myc mouse model of HCC in human HCC by Western immunoblotting of patient sera and immunohistochemistry of human HCC

PART 3

- Investigate the role of GPI-phospholipase D in liver cancer

Applied methods

Maintenance of transgenic mice

The c-Myc transgenic mice are a kind gift from Dr. Dalemans [Dalemans, W *et al.*, 1990].

All animal work followed strictly the Public Health Service (PHS) Policy on Human Care and Use of Laboratory Animals. Formal approval to carry out animal studies was granted by the ethical review board of the city of Hanover (Germany). Transgenic mice were the kind gift of Dr. Dalemans. They were maintained as homozygotes in the C57/Bl6 black round. The transgene was verified by PCR using the forward primer: 5'-CACTGCGAGGGGTTCTGGAGAGGC-3' and the reverse primer: 5'-ATCGTCGTGGCTGTCTGCTGG-3' and the following assay conditions: 15 min 95°C, 1min 60°C, 1min 70°C, 1min 95°C, 31 cycles.

N=6 healthy non-transgenic (C57BL6), n=6 HCC bearing mice aged between 10-12 months and n=3 transgenic mice without cancer aged between 5.5-6.5 months were kept individually with food and water given *ab libitum*.

Patient characteristics

The Ethical committee of the Medical School of Hanover had approved the use of human samples.

Patient characteristics are given in **Chart 1**. Human tumor tissue blocks from patients group **A** (IHC analysis) were provided by Dr. Ferdinand Hofstädter, Institute of Pathology, University of Regensburg (Germany). Tissue blocks were sectioned and processed as described below.

Characteristics of patient group **B**. Sera of HCC patients were obtained from Dr. Arndt Vogel, Hanover Medical School, and used for WBs analyses. Here individuals were chosen according to their tumor staging (i.e. T3/T4, no regional lymph node involvement –N0- and no distant metastasis –M0-).

A) Sera from:	Patient ID	Staging of HCC			Sex	Age	AFP	Therapy
		T	N	M				
<i>Healthy individuals</i>	13	0	0	0	female	21	13	
	25	0	0	0	male	18	25	
	55	0	0	0	female	19	55	
	70	0	0	0	male	36	70	
	60	0	0	0	male	27	60	
	18	0	0	0	male	19	18	
	31	0	0	0	male	42	31	
	35	0	0	0	male	23	35	
	36	0	0	0	female	24	36	
	52	0	0	0	female	19	52	
	59	0	0	0	male	24	59	
<i>HCC patients</i>	347	T3	0	0	male	73	60	Sorafenib
	352	T4	0	0	male	57	7	Sorafenib
	353	T3	0	0	male	78	5	Trans-arterial chemoembolization (TACE)
	364	T4	0	0	male	58	33405	Sorafenib
	373	T3	0	0	male	73	60	Sorafenib
	375	T4	0	0	male	59	174639	Sorafenib
	386	T4	0	0	male	81	24	Trans-arterial chemoembolization (TACE)
	393	T4	0	0	male	52	31	Trans-arterial chemoembolization (TACE)
	399	T4	0	0	male	73	66	Sorafenib / percutaneous ethanol injection (PEI)
	401	T4	0	0	male	60	-	Sorafenib
	115	T4	0	0	female	45	18666	Sorafenib
	163	T4	0	0	female	51	33114	Sorafenib
	200	T3	0	0	female	65	10	Trans-arterial chemoembolization (TACE)
	265	T4	0	0	female	72	5	Sorafenib
	299	T4	0	0	female	84	540	Sorafenib
	359	T4	0	0	female	39	8298	Sorafenib
	366	T4	0	0	female	72	15917	Sorafenib
383	T4	0	0	female	53	10	Trans-arterial chemoembolization (TACE)	

B) Liver tissues from:	Patient ID	Staging of HCC			Sex	Age
		T	N	M		
Healthy individuals	24943/D10(08)	0	0	0	female	68
	14389/E7 (08)	0	0	0	male	54
	17874/B7 (08)	0	0	0	female	72
	22983/6 (08)	0	0	0	male	84
	15374/5 (08)	0	0	0	male	70
	17152/7 (08)	0	0	0	female	61
HCC patients	11899/3 (08)	3	0	0	male	44
	25178/2 (06)	3	0	0	male	80
	22204/ (05)	3	0	0	male	65
	04605/1 (07)	3	0	0	male	56
	22602/3 (06)	3	0	0	male	73
	24954/5 (05)	3	0	0	male	65
	08616/3 (06)	3	0	0	male	72
	12585/8 (08)	3	0	0	male	51
	17798/21 (05)	3	0	0	male	61
	10458/C6 (07)	3	0	0	male	28
	6564/B1 (09)	1	0	0	male	67
	6564/B4 (09)	1	0	0	male	67

Chart 1: Here, characteristics of patients, whose sera (A) and liver (B) were used for WB and immunohistochemistry (IHC) analysis, are shown. The HCC patients were almost all T3 (T= extent of the tumor; N= cancer cells spread to nearby (regional) lymph nodes; M= metastasis).

Tissue and serum proteome analysis

Mouse serum and liver tissue protein extraction

Blood serum was collected from the vena cava and allowed to clot for 2 hours at room temperature. The clotted material was removed by centrifugation at 3000 rpm for 15 min. The obtained sera were immediately frozen in liquid nitrogen and stored at -80°C until further analysis.

Approximately 0.1 g of each mouse liver from n=6 different wild-type and transgenic mice (10-14 months old) was ground in a mortar under liquid nitrogen flow. Then, the samples were processed with 0.5 mL of a buffer containing 40 mM tris base, 7 M

urea, 2 M thiourea, 4% CHAPS, 100 mM DTT and 0.5% (v/v) biolyte. The suspensions were homogenized by sonication (3 × 20 s) and after addition of 3 µL of benzonase for degradation of RNA/DNA they were incubated at room temperature for 20 min. The samples were then centrifuged at 12,000 g for 20 min. The pellets were washed and sonicated for 5 min with further buffer (see above) and centrifuged at 12,000 g for another 20 min. The supernatants were collected.

Protein separation and quantitation by 2-DE

Protein determination

Serum protein concentration was determined by the Bradford assay (Protein Assay Dye Reagent Concentrate, BioRad), using bovine gamma globulin as the standard and ranged between 108 to 128µg/µl for non-transgenic, 128 to 145µg/µl for AAT- c-Myc transgenic mice aged between 5.5-6.5 months and in the case of HCC bearing mice (aged between 10-12 months), the serum concentration ranged between 135 to 160µg/µl; protein concentration for healthy individuals and HCC patients ranged between 90-185µg/µl and between 125-252µg/µl, respectively.

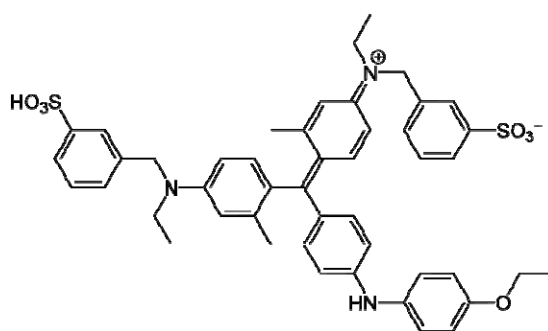

Figure 16: Structure of Coomassie blue G-250. The Bradford Test is based on colorimetric property that Coomassie blue G-250 has at different pHs (it is red at very acid pH-absorbance 470nm- green at “neutral pH-absorbance 670nm- blue when protein linked-absorbance 595nm-)

Two-dimensional electrophoresis

For gel electrophoresis, 500 µg/gel of total proteins from either tissue or serum were loaded and subjected to two-dimensional electrophoresis (2-DE) as described previously. Specifically, proteins were focused by their isoelectric behaviour by use of IPG strips of the same lot/each experiment (12 gels). IPG strips (BioRad) consecutively numbered were used and each IEF experiment (12 gels) was started in the morning, after 12 hours of equilibration. IPG strips were run at pH ranges of 4-7, 3-10 and, in case of liver extracts, of 5-8. Each IEF experiment (12 gels) was followed by 12% SDS-PAGE (DodecaCell, BioRad) after IPG treatment with DDT (2%, w/v) and iodoacetamide (4%, w/v). The second dimension was run to 20mA/gel for 2 hours, followed by 120mA/gel overnight. After washing and fixing steps, the gels were stained with G250 Coomassie Blue. The Coomassie-stained 2-D gels were re-hydrated in ultra pure water for exactly 5 minutes and recorded as digitalized images using a high-resolution scanner (Expression 10000XL, Epson). For the biomarker discovery, the samples from n=6 mouse controls (10-15 months) and the n=6 HCC bearing AAT-c-myc transgenic mice (10-13 months) were run in duplicate in two experiments/each pH (120 gels, in total).

The software analysis was performed using the PDQuest™ software (version 8.0.1, Bio-Rad) with the *Spot Detection Wizard* (**Figure 17**). 2-D spots were automatically matched to a master (=reference) gel, after images warping and manual adding of landmarks present in all gels. Image warping was used to transform gel images so that matched spots can be viewed as overlapping regardless of gel distortion.

Gel images were further processed to remove background noise. Unmatched spots were manually revised and added to the master-gel only when they were present in both replicates and at least in 2 out of 3 biological samples/each group. Spots were considered regulated if quantified in at least 2 out of 3 biological samples/one groups. Specifically, as a group, biological samples from C57Bl6 (control group) and AAT-c-Myc mice (tumor group) were considered. The spot intensity was calculated as normalized values with LOESS (Local Regression Model); data were expressed in *ppm*. Normalization was used to remove systematic gel intensity differences originating, for example, from variations in staining, scanning time and protein loading by mathematically minimizing the median expression difference between matched spots. This allows a satisfactory quantification and comparison of different gels.

Quantification of the 2-D spots was done by means of intensity (total intensity/pixel number) with the PDQuest™ quantity tool. Missing spots were estimated automatically, revised manually and added to the master-gel when present in about 80% of individual animals studied. Technical missing values (within replicas) were discarded. A total of 40% and 20% of missing values remained in serum and tissue 2-DE experiments, respectively.

Spot variation between groups (control and tumour groups) was estimated by the univariate test, foldchange (FC) and coefficient of variation (CV). Differentially expressed proteins were determined with the Student t-test and Mann-Whitney test ($p < 0.05$) of proteins with an FC ≥ 2 for at least one pH range.

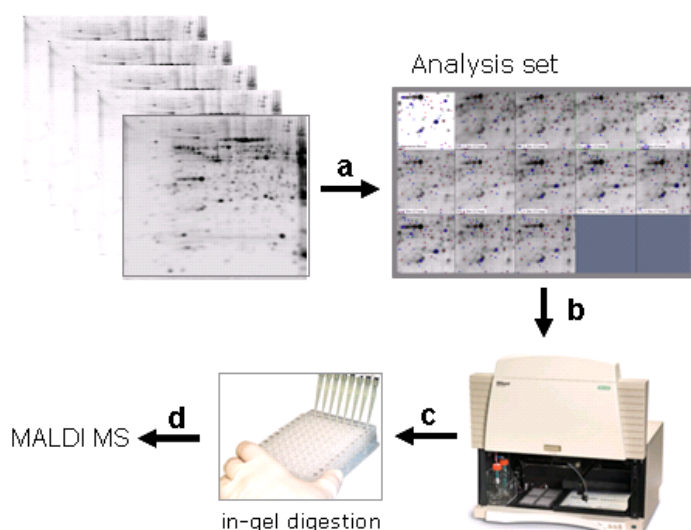

Figure 17: Workflow for detection of 2-D spots and preparation for MALDI MS analysis; **a:** 2-DE analysis and PDQuest™ analysis; **b:** 2-D spot excision and **(c)** trypsin in-gel digestion; **d:** 2-D analysis set is exported to MALDI-MS and the tryptic peptides are analysed with either CHCA or DHB matrix.

Statistical analysis of differentially expressed 2D gel spots

All statistical analyses of 2D spots were done by PDQuest™ software. To reach statistical power, the 2-D maps of replicate gels in order to verify the quality of the experiment were studied. After normalization and before quantitation (Analysis Set, PDQuest™), the scatter plot of 2-D spots from the same biological sample in the two different gels (replicates) were checked and in case needed also manually improved. Overall a linear correlation coefficient of 0.90 was reached.

The Mann-Whitney Signed Rank test, which applies non-parametric statistics, converts all values to ranks, and operates on the ranks was used. This type of test

does not make assumptions about the underlying statistical distribution as opposed to the Student's T-test, which does make certain statistical assumptions about the data. To take the information about reproducibility of the 2-D maps according to the single replicas into account, analysis of the spot volume datasets for the different experiments by the Partial Least Squares (PLS) as multivariate statistical discriminating analysis technique was performed (*Eriksson et.al., Umetrix Academy, 1999*). The choice was set down by the fact that univariate statistical tools (such as Student's T-test) treat each individual variable as being independent, and, thus, can not easily capture information about correlated trends. Finally, univariate tools may increase false-positive results after repeatedly applications. Since proteomic studies based on 2-DE generate large datasets, it is important to be able to achieve statistically reliable decision tools for distinguishing between groups. For that reason, the multivariate statistic tools available in PDQuest™ software (PLS) were used. Spot values were standardized (normalized) for each spot by taking mean and standard deviation of the values across all gels for a spot, and then subtracting the mean and dividing by the standard deviation (namely "Scale spots to ignore size difference"). Overall, for between group comparisons (control vs tumor) the Student's t-test and the Mann-Whitney Signed-Rank test were used, the latter test being more robust against violations of normality. In case of 2-DE of serum proteins, PLS did not always reach significance. For that reason, serum regulated proteins were cross-validated with immunoassay.

MALDI-TOF/TOF mass spectrometry

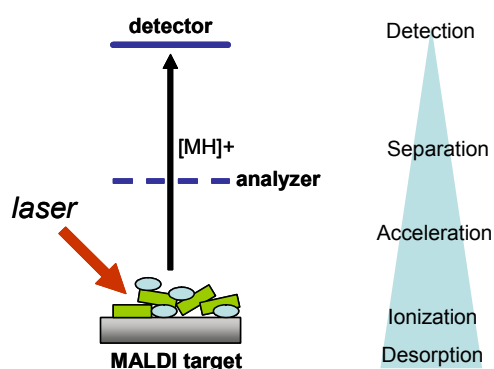

Scheme 2: Scheme of the Matrix-Assisted Laser Desorption Ionization

Tryptic digested peptides were spotted onto a 600 μm /384 well AnchorChip™ sample target and PMF and tandem MS were done with an UltraFlex™ II MALDI-TOF/TOF equipped with a smartbeam™ laser (Bruker Daltonics, Bremen, Germany). Specifically, for sample/matrix preparations we used the α -cyano-4-hydroxycinnamic acid (CHCA) and 2,5-dihydroxybenzoic acid (DHB) matrices; CHCA was saturated in 97% Acetone/0.1% TFA solution; DHB was dissolved in 30% ACN/0.1% TFA at final concentration of 5mg/ml. The matrix-analyte preparations were loaded by the thin layer and the matrix layer (ML) method as described recently [Garaguso, I et.al., 2008]. A mix of peptide standards was used to calibrate the instrument and as external calibration of spectra (Peptide Calibration Standard for Mass Spectrometry, covered mass range ~1000-4000Da, Bruker). Additionally, internal calibration was achieved using trypsin autolysis products (m/zs 1045.564, 2211.108 and 2225.119) resulting in a mass accuracy of ≤ 50 ppm. Spectra were collected by FlexControl™ (2.0, Bruker) without smoothing or baseline subtraction and when peak resolution was higher than 6000 or 7000a.u. in case of DHB and CHCA, respectively. Then, the spectra were sent to FlexAnalysis™ (v.2.4, Bruker), which labelled the peaks for protein identification by ProteinScape™ v.1.3 or BioTools™ v.3.1 (Bruker). Trypsin autolysis products, tryptic peptides of human keratin and matrix ions were automatically discarded by ProteinScape™ (mass control list). ProteinScape™ Score Booster feature was used to improve database search results by automatic iterative recalibrations and background eliminations. Protein scores greater than 53 were

considered significant ($p < 0.05$, Mascot) (Mus) [Ritorto,MS et.al., 2008]. In addition, mouse proteins were requested as the top candidates in the first pass search when no restriction was applied to the species of origin. Identified proteins were checked individually for further considerations. Peptide masses were searched against the Swiss-Prot database (download 2005 - 197228 sequences, 71501181 residues -) employing MASCOT (in-house MASCOT-server, Matrix Sciences Ltd, <http://www.matrixscience.com/>, revision 2.0.0), taking into account carbamidomethyl of cysteines -Carbamidomethyl (C)- as fixed modification and possible oxidation of methionine -Oxidation (M)- as a variable modification but allowing one missed cleavage. Based on initial data, ion precursors were selected by ProteinScape™ for tandem MS data acquisition. In the MASCOT MS/MS ions search, restriction at *Mammalia* species was applied with peptide tolerance of ± 70 ppm and MS/MS tolerance of ± 0.9 Da (fixed and variable modifications as PMF). A result was considered acceptable when the *Individual ion scores* was > 27 , indicating identity or extensive homology ($p < 0.05$). A wide peptide tolerance was not chosen to avoid long searching time and, mostly, without significant effect on the score. This is because most of the discrimination comes from the MS/MS fragment ion matches. On the other hand, a tighter peptide tolerance, in an effort to improve discrimination, may result in lost peptide matches, which would dramatically reduce the overall score.

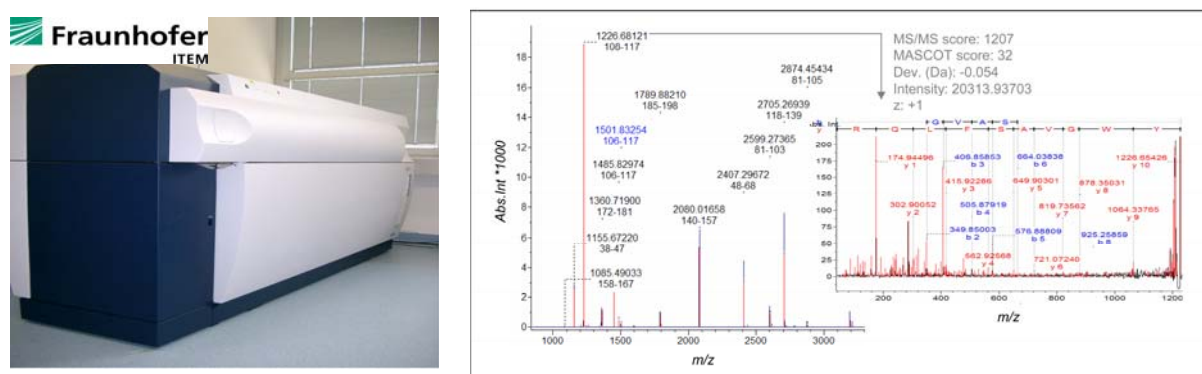

Figure 18: On the right, an example of peptide mass fingerprint (PMF) and peptide fragment fingerprint (PFF) which leads to the identification of serum retinol binding protein (RBP4). On the left, the MALDI TOF-TOF MS, Ultraflex II, Bruker.

Validation of protein regulations

Western immunoblotting

Serum protein extracts were subjected to Western immunoblotting using polyclonal goat and/or rabbit antibodies against alpha-fetoprotein, apolipoprotein E, serum retinol binding protein 4, serum amyloid P in a 1:200 dilution and major urinary protein and transthyretin in a 1:100 dilution (Santa Cruz Biotechnology) and apolipoprotein M in a dilution of 1:10000 (BD Bioscience). Polyclonal monospecific antibodies against PIGR and PHLD were purchased by Atlas Antibodies (Sweden). Notably, total protein extracts from HepG2 human hepatoma cells and Hela total cell extracts served as positive control. Detection was based on the ECL (PerkinElmer) and WesternDot™ 625 (Invitrogen) systems according to the manufactory recommendations. Images were recorded on the Kodak ds (IS 440CF) or alternatively with the Pharos FX™ Plus Molecular Imager with External laser Molecular Imager FX (BioRad) in the case of the Qdot® 625 nanocrystals of streptavidin conjugates. Band semi-quantitation was achieved with the QuantityOne® 1D Analysis software (version 4.6.1; BioRad) using local background subtraction, while data were expressed relative to alpha-tubulin (T/C 1.01±0.25) that served as a housekeeping protein.

Immunohistochemistry

Healthy livers of n=5 individuals aged between 53 and 83 and n=12 cases of HCC aged between 26 and 77 were analyzed. Each tumor section (2-4µm in thickness) was de-paraffinized with Roti-Histol and dehydrate in a descending alcoholic solution according to standard protocols. To unmask the antigens the sections were immersed in citrate buffer and placed in an autoclave for 15 minutes. Endogenous peroxidase activity was blocked with a 3% hydrogen peroxide/methanol peroxidase blocking solution for 30 minutes. Then, the sections were washed with water and incubated with a solution containing the primary polyclonal antibody either against apolipoprotein E or serum amyloid P (at dilution 1:200); staining for hemopexin, paroxonase 1 and major urinary protein was at 1:30. In the case of c-Myc, glutathione peroxidase 3, retinol binding protein and prealbumin a 1:50 dilution of primary

antibody was used and incubated for 45 minutes. After a further washing step a streptavidin horseradish peroxidase detection kit (Envision DAKO) was employed to visualize the protein of interest as recommended by the manufacturer. Harris Hematoxylin (Roth) was used as a counter-stain. The specificity of the reaction was further validated by use of mouse immunoglobulin G instead of the primary antibody.

Gene expression data of regulated proteins

All genomic data from Arraytrack were filtered through the total bag flags (<40%), mean intensities (>200), p-value (<0.05) and fold change (>2).

Extraction of total RNA

RNA-extraction was performed on three control mice and three AAT-c-myc transgenic mice at 2, 6 and 12 months, respectively, with the RNeasy Mini Kit (RNeasy MidiKit Qiagen, Santa Clarita, CA, USA) according to the manufacturer's instruction and measured by NanoDrop ND-1000 (NanoDrop software, version 3.0.0).

Sample preparation for analysis with Affymetrix GeneChip® System

Total RNA (5µg) was used to generate biotin-labeled cRNA (10 µg) by means of GeneChip® One-Cycle cDNA Synthesis Kit and GeneChip® IVT Labeling Kit (Affymetrix). Quality control of cRNA was performed using a Bioanalyzer (Agilent 2001 Biosizing, Agilent Technologies) and labeled cRNA of each sample was hybridized to Affymetrix GeneChip® Mouse Genome - 430 2.0 arrays by Hybridization Oven 640. The arrays were scanned using the GeneChip® Scanner 3000.

GeneMANIA

To predict the gene networking, the GeneMANIA algorithm was employed. It consists of two parts: an algorithm, based on linear regression, for calculating a single, composite functional association network from multiple networks derived from different genomic or proteomic data sources; and a label propagation algorithm for predicting gene function given this composite network [Mostafavi, S et.al., 2008].

Bioinformatics

Search for c-Myc binding sites in promoters of regulated genes/proteins

The *Mus Musculus Promoter Database* was used to extract the promoter regions of genes coding for the regulated proteins [Zhang, MQ, 2003]. For each promoter, the lengths of the 1000bp upstream region and 100bp downstream region of known/predicted transcript start was chosen [Haggerty, TJ et.al., 2003]. The promoters were then analysed with positional weight matrices (PWMs) by TRANSFAC® (professional rel 10.1, BIOBASE GmbH, Germany). Specifically, TRANSFAC®-integrated MATCH™ (Matrix Search for Transcription Factor Binding Sites, 2010.1) was exploited. The matrix profile was done by us (MATCH™ Profiler) including 6 different matrices (M00118, M00322, M00615, M01034, M01145, M01154) in high quality mode (**Figure 20**). Finally, the default cut-off values for matrix similarity was used, whereas the cut-off for the core similarity at 0.75 was set [Reymann, S et.al., 2008].

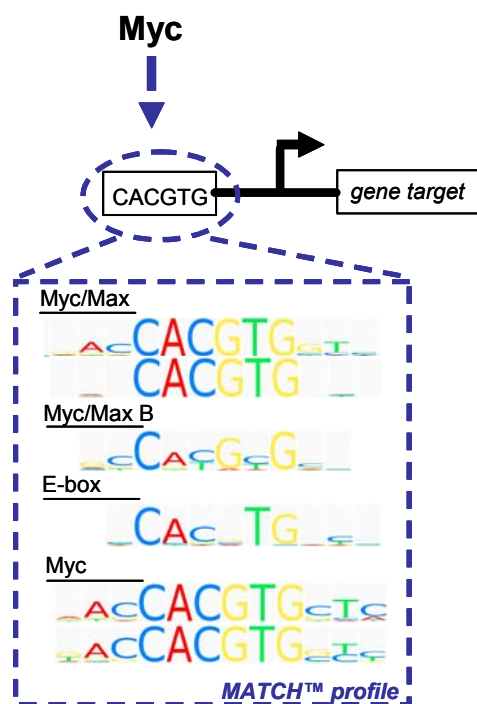

Figure 20: Scheme of matrices used for E-box sequence search (BIOBASE).

GPI-anchored protein predictors

The search for GPI-anchor protein genes was made using four predictors:

BigPI-Metazoa-, *PredGPI*, *GPI-SOM*-no taxon-specific- and *FrangAnchor*.

According to a study conducted in 2006 at the Swiss Institute of Bioinformatics on the prediction performance of three programs (*BigPI*, *DGPI* and *GPI-SOM*) the *BigPI* predictor has reported the minor amount of false positives and therefore, it was chosen for first identification of ω -sites. *BigPI*-algorithm is based on sequence properties extracted from a positive set; while *GPI-SOM* is supposed to predict GPI-anchoring for unknown proteins, based on Kohonen's SOM (Self Organising Map) approach. The Kohonen neural networks are known to be powerful tools for classification of hidden information in large datasets. *FragAnchor* is based on the tandem use of a Neural Network predictor and a Hidden Markov Model predictor. The Neural Network is used to select the potential GPI-anchored sequences and the Hidden Markov Model classifies the selected sequences according to four different levels of precision (highly probable, probable, weakly probable, potential false positive). The Hidden Markov Model proposes also up to three possible locations for the anchor/cleavage site. *PredGPI* (2008) is a prediction method that, by coupling a Hidden Markov Model (HMM) and a Support Vector Machine (SVM), is able to predict efficiently both the presence of the GPI-anchor and the position of the ω -site. *PredGPI* is trained on a non-redundant dataset of experimentally characterized GPI-anchored proteins whose annotation was carefully checked in the literature [Deeg, MA et.al., 2001a].

Gene Ontology

PubGene beta and *ProteinLounge beta* were used for classification of the proteins, according their most reported GO association in literature and their pathways.

PubGene beta has been designed to present information on genes, proteins and related keywords in an organized and intuitive form by graphic interfaces connecting to published data citations and co-cite gene identification records [Jenssen, TK et.al., 2001]. All information that were considered significant were collected ($p < 0.05$).

ProteinLounge beta represents a comprehensive and free web-based database which allows for protein pathways, protein-protein interactions and transcription factor database, as the most. The detailed information obtained from the database was the basis of the system biology study in this work.

.

Results & Discussion

Part 1:

- *Development of an improved method for serum protein identification*
- *Map the serum protein of healthy mouse sera*

This part of the doctoral work was published in 2008:

“A simple and reliable protocol for mouse serum proteome profiling studies by use of two-dimensional electrophoresis and MALDI TOF/TOF mass spectrometry “

Maria Stella Ritorto and Jürgen Borlak

Proteome Science 2008, PMID: PMC2563006

Background

Searching for potential candidate biomarkers in bio fluids, such as serum, is a challenging task, whether it is considered that they may be present in blood at low abundance and may be masked by several other proteins working as carriers and present abundantly.

To overcome this drawback, a modified proteomic protocol based on conventional proteomic workflow has been developed.

Two-dimensional electrophoresis of serum proteins

By this study, narrow 2-D gels improved detection of low abundant proteins in sera, thereby avoiding any pre-fractionation. The 2-DE proteomics carries the advantage of visualizing changes in Mw and pI of a protein, which is helpful in highlighting biologically significant processes. This electrophoresis technique has been applied successfully to identify oncoproteins in human serum and tissues [Chen,R et.al., 2005, Cho,WCS, 2007, Gorg,A et.al., 2004, Juan,HF et.al., 2004]. Notably, mouse serum proteins were separated by 2-D electrophoresis (2-DE) and resolved in the first dimension in a broad pH range with IPGphor strips (pH 3 to 10 NL), and subsequently in a 12% gradient polyacrylamide SDS gel in the second dimension. On average, 350 spots could be detected and 77 unique mouse proteins were identified, of which more than 30% were in the basic region of the gel.

The sample complexity was further reduced by the use of IPG strips in the pH range of 4 to 7. The number of spots was increased by 2-fold. Approximately 660 spots were detected and 59 proteins were identified in this pH range. When compared with gels of the 3 to 10 pH-range, multiple isoforms of proteins can now be visualised and may have arisen from a combination of post-translational modifications as well as chemical modifications that occur during sample preparation [Gorg,A et.al., 2004]. Apart from high abundant proteins, on average three spots for each protein at pH of 4 to 7 could be detected, when compared to one spot for each entry or smears observed with gels at pH of 3 to 10 (**Figure 21**).

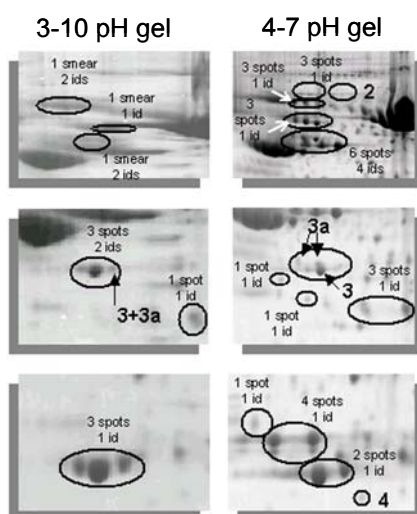
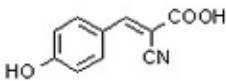
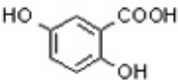

Figure 21: Examples of resolution of the protein smears by the use of narrow ranges of pH (rearrangement of Figure 2 – Ritorto MS, Borlak J, Proteome science 2008)

Improved MALDI TOF-MS analysis of serum proteins

To increase the number of ionized tryptic-digested peptides, the properties of two commonly used matrices, CHCA and DHB were exploited. These matrices differ considerably upon MALDI ionization. CHCA is perceived as more efficient in ionization, often resulting in higher signal intensity, and is preferred for low-abundance peptides. DHB, on the other hand, produces less background signals from matrix clusters and thus better reveals signals in the lower m/z region and is preferred in protein posttranslational modification (PTM) studies since modifications are likely to remain intact during ionization.

Matrix structure	Matrix full-name	Suggested solvent
	α -cyano-4-hydroxycinnamic acid (CHCA)	saturated in (97% Acetone, 0.1% TFA)
	2,5-dihydroxybenzoic acid (DHB)	5mg/mL in (30% AcN, 0.1% TFA)

Scheme 6: Here the two matrices used in the work are shown, namely the CHCA and the DHB. The solutions in which either CHCA (Bruker's instruction) or DHB (ML matrix, Garaguso et al, 2008) were prepared are also described.

However, one the main challenge in using DHB is its low homogeneity onto the target. The AnchorChip® technology (Bruker), equipped with hydrophilic patches surrounding ("anchors") in hydrophobic surroundings which allows for concentration of material in the anchor was used; however, the commonly method for preparing sample-matrix, namely dried droplet deposition, has given difficulties when an

automated acquisition was applied. As shown below, the homogeneity of the sample-DHB is compromised and mostly not reproducible, making difficult any automatic movement of the laser by the MS software.

In the improved method described here, DHB was prepared in 0.1% TFA acidified solution containing 30% ACN. DHB concentration was set at 5 g/L, in order to achieve crystallization solely on the anchor surface but keeping an optimum of analyte-to-matrix ratio. Similar to the conventional CHCA TL preparation, for the DHB preparation method the matrix solution is deposited onto the MALDI target and allowed to dry. Subsequently, an acidified analyte solution is deposited onto the dried DHB matrix. Finally, the preparation is recrystallized “on-target” using a solution containing ethanol/0.1% TFA (80:20 v/v) (**Figure 22**).

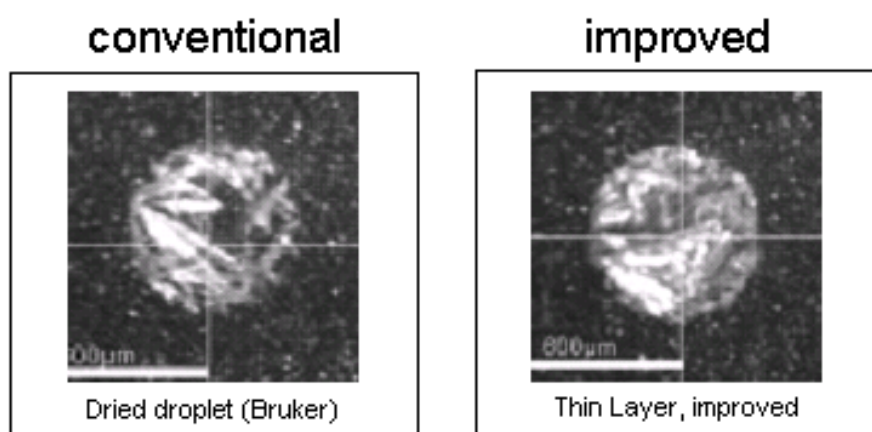

Figure 22: Here is depicted the shape of sample: DHB mix on the AnchorChip. The distribution of the modified thin layer preparation described above resulted high homogeneous, in comparison with conventional dried droplet

The re-crystallization of the sample-matrix mixtures loaded on the target increased considerably the number of identifiable peptide ions in an automated MS and MS/MS spectra acquisition mode. Striking differences in the MALDI MS spectra of peptides were observed when the two matrices were compared (**Figure 23**).

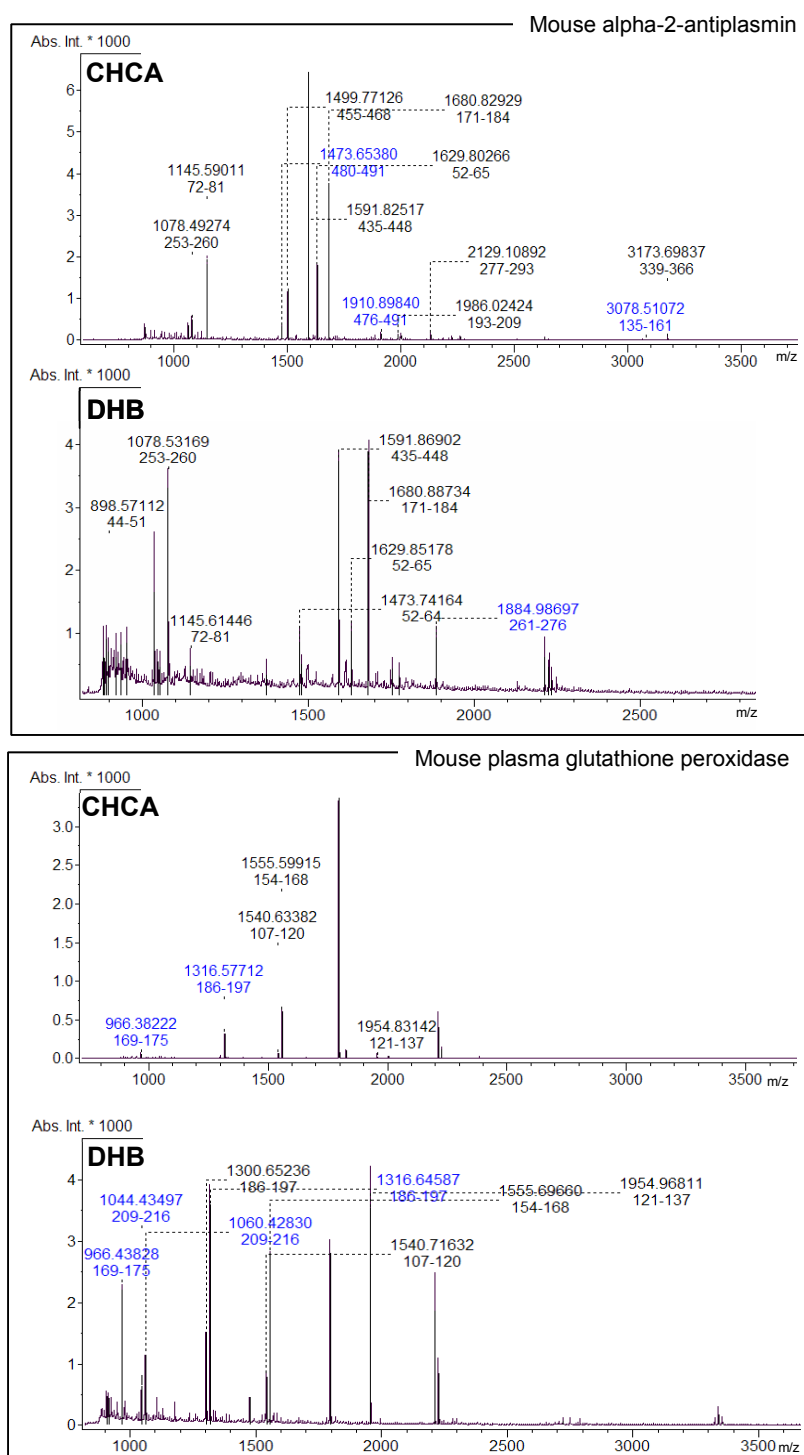

Figure 23: Spectra comparison between CHCA and DHB. Here the spectra of the mouse alpha-2-antiplasmin (A2AP_MOUSE) and glutathione peroxidase 3 (GPX3_MOUSE) are compared. Rearrangement of Figure 3 in PMID: PMC2563006. In blue are the modified peptides or matrix clusters.

Better ionization of peptides from the tryptic-digested proteins was observed with DHB as compared with CHCA. Indeed with CHCA, frequently peaks at m/z 1044, 1060, 1066, 1082, 1249 and 1271 were observed. Matrix ion suppression in deflection mode of m/z 800 was applied. These abundant matrix clusters display high s/n ratio and resulted in poor acquired PMF spectra [Smirnov,IP *et.al.*, 2004]. Previous reports had already highlighted differences in PMF because of different behaviour of the two matrices [Laugesen,S *et.al.*, 2003, Padliya,ND *et.al.*, 2004]. In particular, Zhu and Papayannopoulos tested several matrices and reported that DHB gave the best results without interferences from matrix ion peaks [Zhu,X *et.al.*, 2003]. Furthermore, common interferences from matrix-adducts of CHCA were observed, in particular in the range of m/z 800–1100 of the MALDI spectra.

Nonetheless, there are obvious benefits in the use of the CHCA matrix in the MALDI MS analysis. This included a high uniform layer, which it forms, especially on the AnchorChip™ (data not shown). Its ability to induce desorption of ions at lower laser energies demonstrates transfer of sufficient energy for the pre-formation of ions. In some cases, metastable ions of matrix ion fragments were less formed when compared with DHB [Krutchinsky,AN *et.al.*, 2002]. This enabled acquisition of less ambiguous spectra for the identification of proteins. The different behaviours of both matrices are the subject of several published studies. In particular, Luo *et al.* [Luo,GH *et.al.*, 2002] reported loss of internal energy of ions generated by MALDI and the role of the two matrices in desorption and ionisation processes.

Indeed, in a complex mixture such as serum, it is not really clear why in some cases diagnostic PMFs are obtained with DHB rather than CHCA and *vice versa* and it is difficult to predict which matrix would deliver best PMFs. For that reason, both matrices were exploited in order to redress any drawbacks of one matrix by the use of the other one especially in automatic data acquisition procedures.

Application of the improved method: mapping of the mouse serum

To establish the usefulness of this proteomic approach, mapping of the serum protein content of C57BL6 wild type mice was performed. A total of 90 unique proteins were identified, some of which were reported to be identifiable only after sample pre-treatment or sophisticated and time consuming procedures. For instance, several

members of complement factor family [CFAB_MOUSE, CFAI_MOUSE, CO3_MOUSE, CO4_MOUSE, CO9_MOUSE and C1QB_MOUSE], properdin [PROP_MOUSE] and mannose binding protein A [MBL1_MOUSE] were identified at the basic pH region of the 2-D gels. None of them were reported in previous mouse serum proteome profiling studies using 2-DE and MS analysis [Duan,XB et.al., 2004, Duan,XB et.al., 2005, Wait,R et.al., 2005]. Indeed, when the serum was albumin-depleted, other high abundance proteins were lost as well. Furthermore, complement factor 3 and transthyretin were found in both fractions, albumin-rich and depleted (**Table 1**) [Chen,YY et.al., 2005]. This necessitated repetitive analyses. Indeed, complement factor 3 was shown to be up-regulated in human lung adenocarcinomas [Kuick,R et.al., 2007], as were increased serum levels of transthyretin and down-regulation of transferrin in human type-2 diabetes [Sundsten,T et.al., 2006].

This protocol enabled automated data acquisition and improved significantly the identification of proteins based on higher sequence coverage and the number of matched peptides. For instance, CFAH_MOUSE was identified with a Mascot score of 269, a 31% sequence coverage and 29 matched peptides, instead of 23% sequence coverage and 6 and 18 matched peptides as reported previously (**Table 1**). Similarly, the sequence coverage of apolipoprotein H (APOH_MOUSE) was increased by 17% with 5 additional peptides that could be mapped to this protein [Chen,YY et.al., 2005, Duan,XB et.al., 2005].

A total of 13 different serum proteins were identified as novel (see **Table 2**).

For instance, members of complement cascade activation, a positive mediator for angiogenesis (ANGL6_MOUSE), proteins specifically regulated in several tumor cells such as KPYM_MOUSE and proteins playing an important role in protein degradation and protein ubiquitinylation, whose altered activity could allow for abnormal cell proliferation (CUL-1_MOUSE), were newly identified and, interestingly, some of them might serve as cancer biomarkers [Lai,KKY et.al., 2008, Nalepa,G et.al., 2003, Oike,Y et.al., 2004, Roigas,J et.al., 2003].

Perspectives

Proteomics experimental design should include decisions regarding how to reduce the complexity of the sample (depletion, fractionation, digestion, tagging, affinity capture, and optional clean-up) and how to analyze the sample (LC-MS, LC-MS/MS, MS/MS, MALDI/SELDI MS, 2-D gel electrophoresis, FTMS). In general, with each additional step, reproducibility will decrease and loss of proteins will increase. The combination of zoom in gels and the use of two different sample-matrix preparations in sequence improved protein identification of mouse serum proteins considerably and allowed for automated data acquisition as compared to previous methods using 2-DE and MALDI-MS.

The first part of this doctoral work describes a simple and reliable identification of mouse serum protein and as shown in **Table 2**, and evidences an improved identification when compared with previous studies based on pre-treatments of serum or other sophisticated methods.

Part 2:

- Search for novel serum biomarkers of HCC in the c-myc transgenic mouse model of liver cancer
- Confirm disease regulated proteins identified in the c-Myc mouse model of HCC in human HCC by Western immunoblotting of patient sera and immunohistochemistry of human HCC

This part of the doctoral work is included in a second article:

“A combined serum and tissue proteomic study applied to a c-Myc transgenic mouse model of hepatocellular carcinoma identified novel disease regulated proteins suitable for diagnosis and therapeutic intervention strategies “

Maria Stella Ritorto and Jürgen Borlak

Journal of Proteome Research 2010, under review

Background

There is strong evidence for c-Myc to be frequently over-expressed and to be hyperactive in liver cancer [Dang,CV et.al., 1997, Dang,CV et.al., 1999a, Hui,LJ et.al., 2008]. Notably, the c-myc proto-oncogene encodes a transcription factor known to influence expression of a large number of genes, including cell proliferation and differentiation [Chan,KL et.al., 2004, Guo,QM et.al., 2000] and there is strong evidence for c-myc to function as an oncogenic transcription factor in hepatocarcinogenesis.

To better understand its role in carcinogenesis, a c-Myc transgenic mouse model of HCC was investigated by the improved proteomic approach described in Part 1. Based on a combined serum and tissue proteomic approach, novel c-Myc regulated proteins were identified and further validated by IHC and WB in tissue and serum of HCC patients to explore their usefulness as disease biomarkers and for their possible use in targeted therapeutic intervention strategies.

Proteomic approach

Following the model described by Dalemans and co-workers, transgenic mice for c-Myc which specifically developed HCC around at 8-12 months of life were produced. The transgenicity was verified by PCR, as described in *Applied Method* section and the serum and total liver protein extracts from wild type and AAT c-Myc transgenic mice were analysed with the protocol described above.

In total, 49,430 MS spectra were obtained to give rise to more than 9,000 peptide mass fingerprints (PMF) and ~3000 peptide fragment fingerprints (PFF) which were selected automatically by the ProteinScape™ database according to their goodness. The search was done against SwissProt database and was validated against NCBI non-redundant protein database. Overall, the amount of PMF identifications, which represented the differentially expressed and *de novo* regulated proteins, was 1968 (PFF= 381) and 989 (PFF= 496) for sera and tissue, respectively. Proteins, commonly regulated in tissue and serum, were also searched.

A total of n=17 serum proteins were regulated of which 4 are novel while a total of 73 regulated proteins are tissue specific of which 22 are new. In total, the study results in n=28 newly regulated proteins in HCC and demonstrate 5 of them being commonly regulated in serum and tissue (see **Figure 24**).

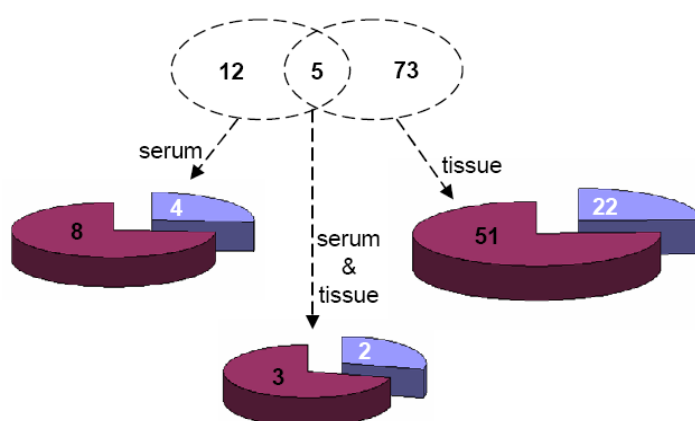

Figure 24. Diagram of regulated proteins in tissue and serum of AAT-c-myc transgenic mice. In white are highlighted the number of newly identified proteins in HCC.

The identification obtained by peptide mass fingerprints were further validated by tandem MS (MS/MS).

Validation

Once potential candidates are recognized, the key step becomes validation. Indeed, a combination of 2D-PAGE and MS/MS allows for identification of few abundance proteins that differed in abundance between the two sample types (e.g. tumor vs control).

MS spectra obtained by the improved method described above, were easily validated by tandem MS (MS/MS), since it was demonstrated that this improved MALDI sample preparation enabled high quality MALDI-TOF MS and MS/MS automated spectra acquisition, due to an improved analyte/matrix distribution and high crystals surface homogeneity.

As an example, the most MS identifications regarding the differentially expressed proteins in mouse sera were validated by MS/MS (**Table 3**)

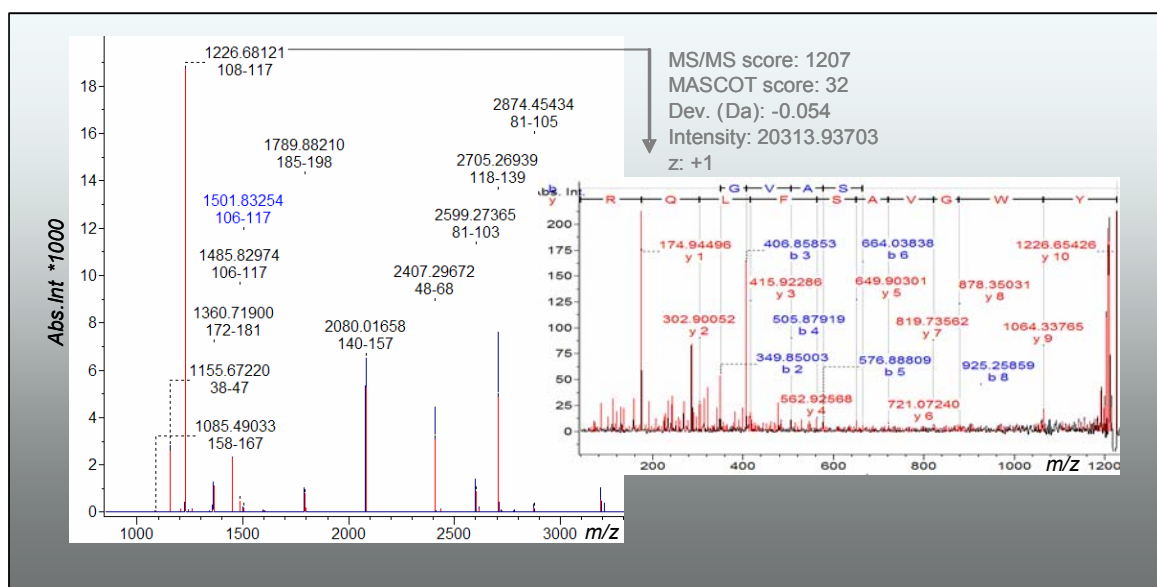

Figure 25: Here is depicted a MS spectrum which identified serum retinol binding protein and the MS/MS of the parental ion at m/z 1226, which confirmed the identification.

Immunological validation and translational research

Traditionally, MS has been used for discovery in a handful of carefully selected samples, whereas antibody-based techniques have been used for larger scale validation. Moreover, to render the identified candidate biomarkers in animal models of interest for clinical trial, the results must be translated on human samples.

In the light of that, regulation of some proteins was investigated by Western immunoblotting and immunohistochemistry of mouse and human HCC. Notably, alpha-fetoprotein was up-regulated in serum of HCC mice, while its expression varied considerably amongst patients.

Based on WB of serum proteins, a clear pattern could be observed. With 5-6 months old mice expression of apoE, retinol binding protein 4, transthyretin, glycosylphosphatidyl-inositol specific phospholipase D (GPI-PLD) and the secretory component of polymeric immunoglobulin receptor (SC-PIGR) increased with disease progression being strongly up-regulated in 12 months HCC bearing mice (**Figure 25**).

With mouse apoE an additional immunoreactive band was visible, probably corresponding to one of the two fragments, detected early in 2-D gels of serum proteins. In contrast, expression of MUP(s) declined with progressive disease and was below detection in 12 months old HCC mice.

With human HCC and in the case of GPI-PLD, serum amyloid component P and SC-PIGR a similar up-regulation was observed, while expression of afamin was completely abolished (**Figure 26**).

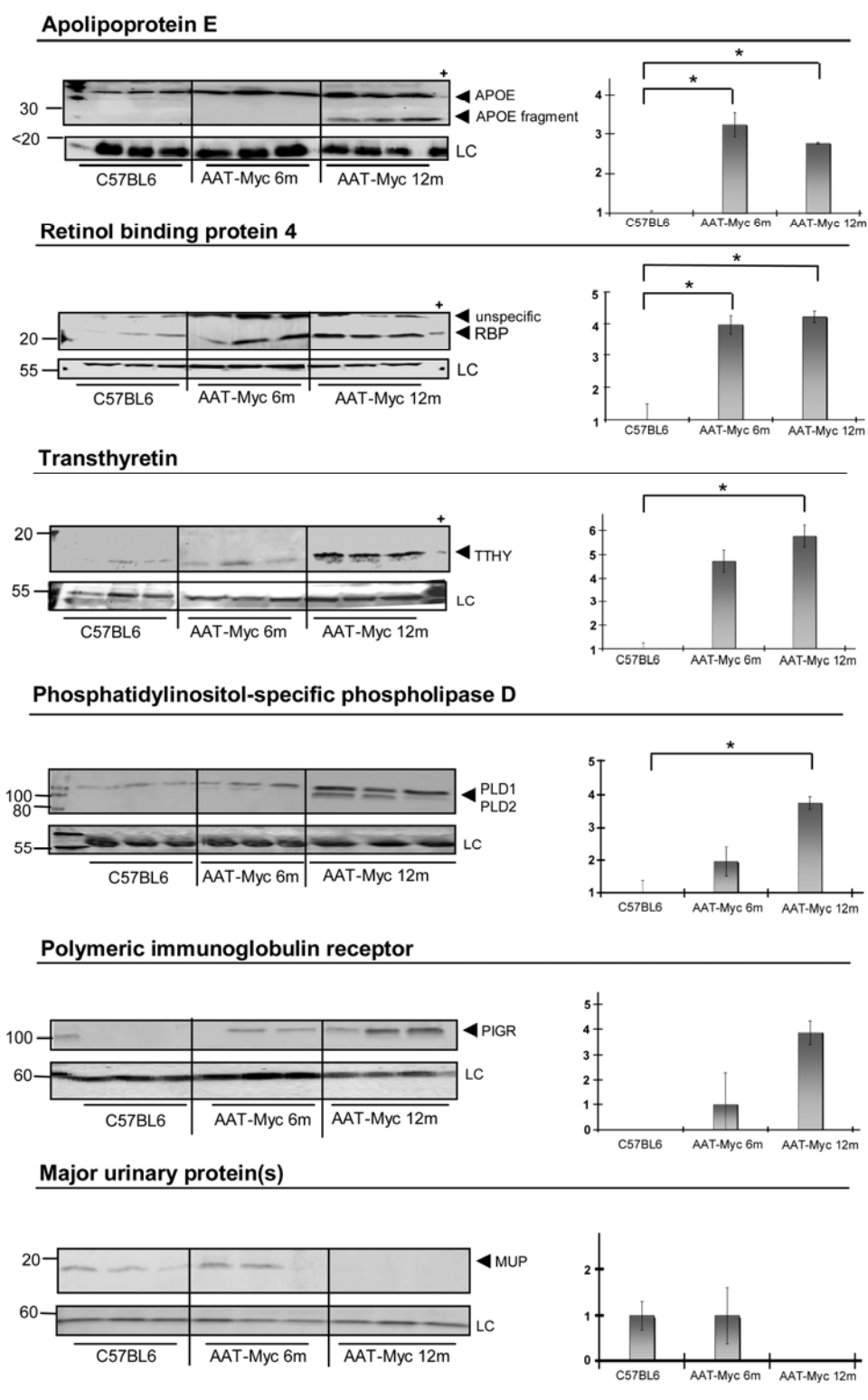

Figure 25: Western blot band-quantitation by QuantityOne® software. The * indicate variations statistically significant ($p < 0.05$). PLD1 and PLD2 are two isoforms of GPI-PLD. + indicates the positive control (HepG2) and LC stands for loading control (α -tubulin).

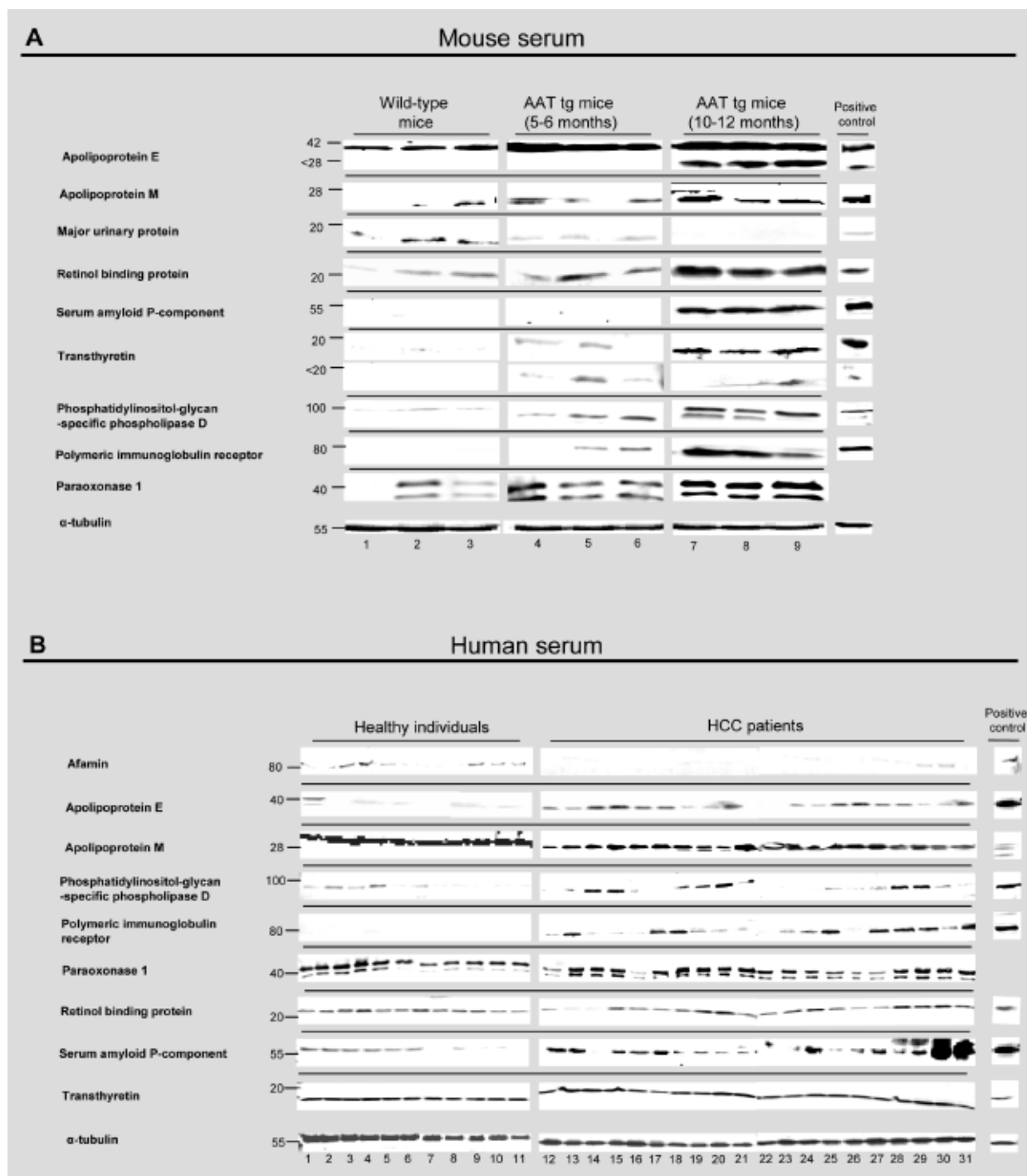

Figure 26: Western blot analysis of mouse (A) and human (B) sera from healthy and tumor samples, respectively.

Further serum proteins of considerable interest were retinol binding protein 4 and transthyretin. Regulation of these serum proteins was studied by Western immunoblotting of n=31 patients diagnosed with either non-alcoholic steatohepatitis (NASH), alcoholic cirrhosis, chronic viral infection (HBV and HCV) or diabetes (DDMII). Here it has been demonstrated that retinol binding protein 4 and transthyretin were strongly up-regulated in HCC cases with DDMII and alcoholic cirrhosis, but less so in NASH or DDMII with NASH (**Figure 27**).

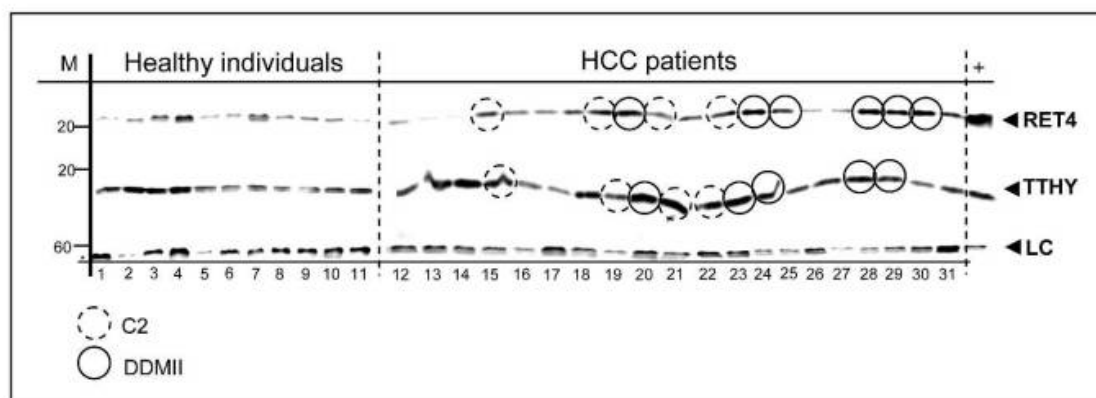

Figure 27. Western blot for the serum retinol binding protein (RET4) and transthyretin (TTHY) on sera from a cohort of HCC patients with different concomitant diseases is depicted. NASH cases without HCC were also analysed. The α -tubulin was used as loading control, whilst HepG2 extracts as positive control (+).

Additionally, disease regulated proteins were studied at the gene expression level with 41% and 52% of regulated proteins in serum and liver tissue being unchanged at the mRNA-level (**Figure 28**).

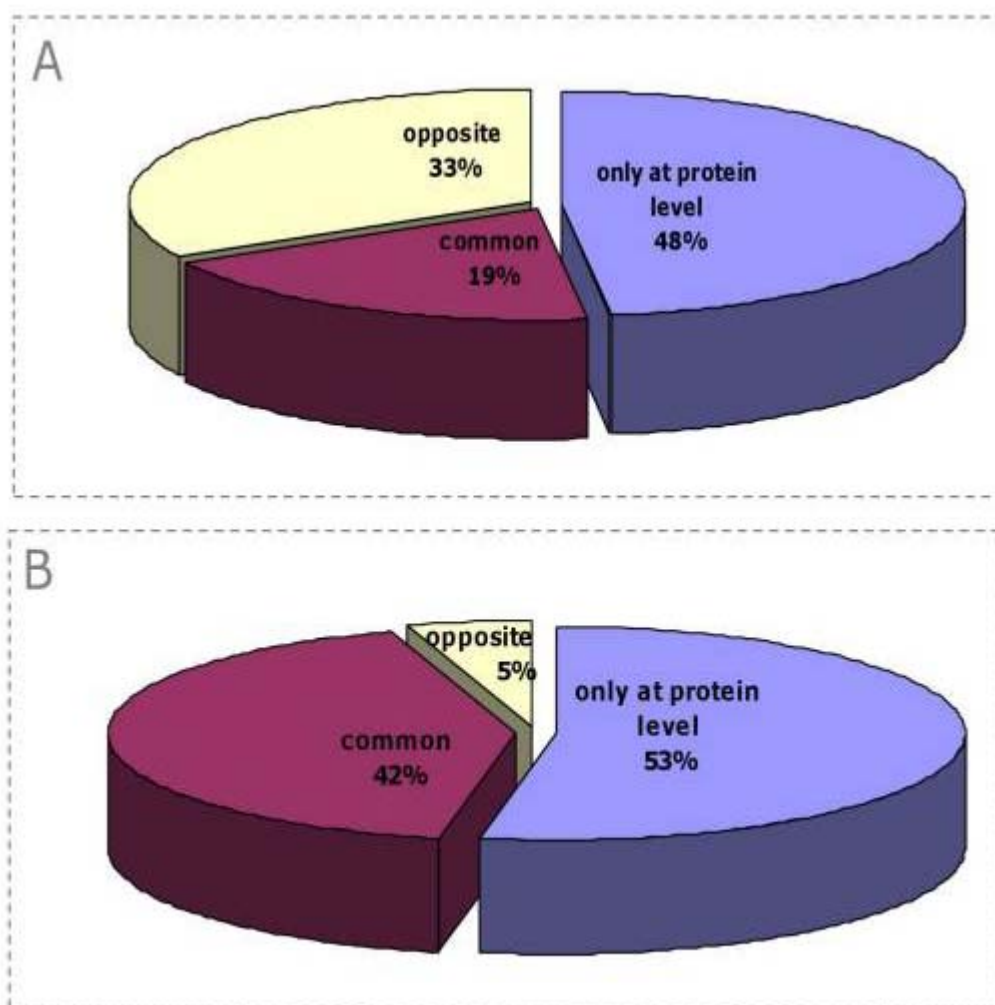

Figure 28. Correlation between protein and gene expression in mouse HCC.

Figure 6: Comparison of gene and protein regulations in HCC transgenic mice

A. Depicted is the comparison of significantly regulated proteins found in serum of HCC transgenic mice.

Their regulation is also studied at the gene and protein level in liver cancer.

B. Depicted is a comparison of significantly regulated genes and proteins found in liver tissue of HCC mice.

The pie charts are coded as follow:

blue = regulation only at the protein level

purple = common regulation at the gene and protein level

yellow = opposite regulation when gene and protein expression is compared.

Regulation of proteins was also investigated by IHC in mouse and human liver tissue. As depicted in **Figure 29**, a similar distribution of hemopexin (mostly cytoplasmatic) but opposite regulation of the major urinary protein family in human and mouse liver tissue was observed. Moreover, nuclear staining for Mup in human control tissue was observed. Moreover, nuclear staining for Mup in human control tissue was high, while a predominant cytoplasmatic staining in liver tissue of control and AAT-c-Myc transgenic mice was noted.

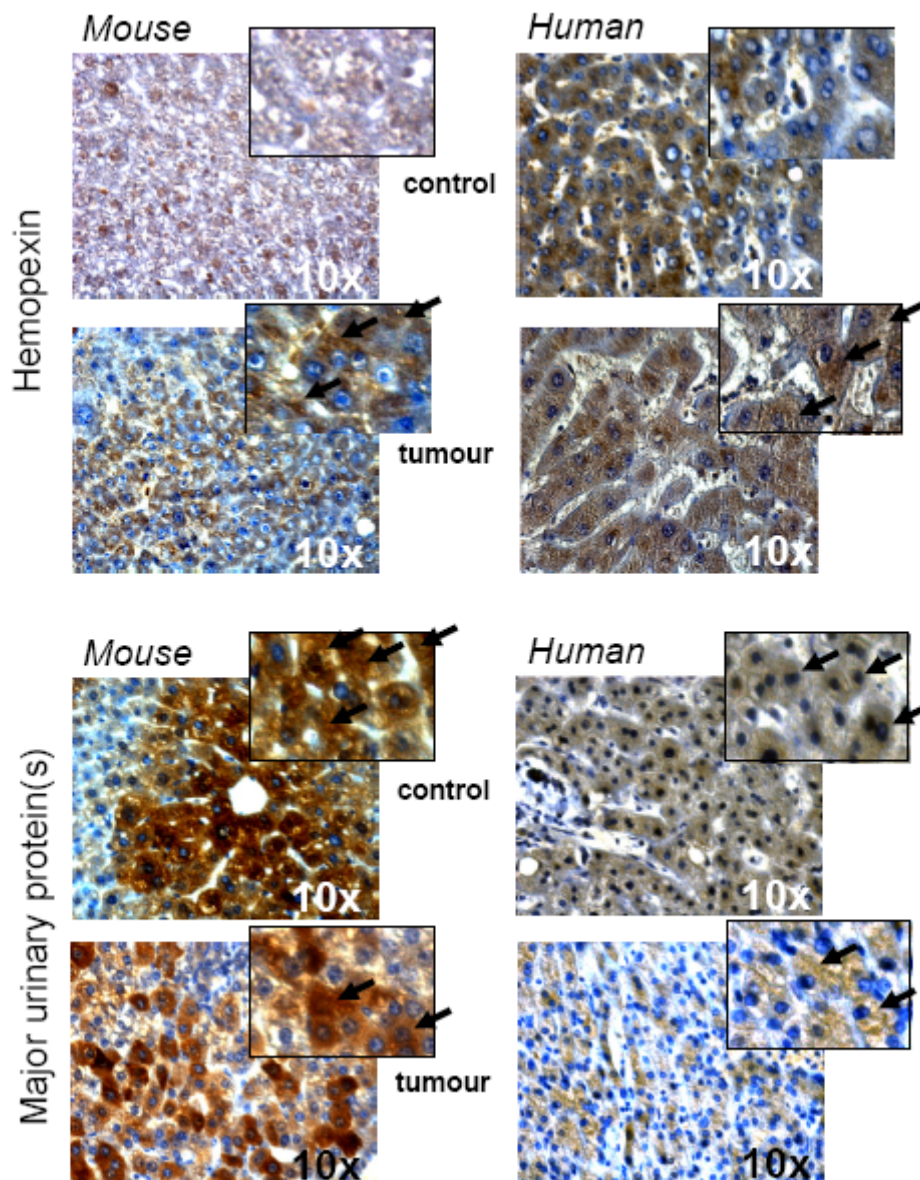

Figure 29. Immunohistochemistry of hemopexin and major urinary protein in health and HCC bearing mouse and human liver tissue, respectively. Typical images of hemopexin (HEMO) and major urinary protein (MUP) are depicted. Note HEMO is opposite regulated in tissue and serum and nuclear MUP staining of control tissues was evident only in human livers.

Bioinformatics

The oncoprotein c-Myc plays an important role in cell proliferation, transformation, inhibition of differentiation and apoptosis. These functions most likely result from the transcription factor activity of c-Myc. As a heterodimer with Max, the c-Myc protein binds to the E-box sequence (CACGTG).

The position weight matrices (PWM) to search for c-Myc recognition sites in genes coding for regulated proteins was applied. As been shown in **Table 4**, 71% of the newly identified proteins presented E-boxes (32% for E-box for Myc/Max and 39% for a generic E-box recognition motif) (**Figure 20**).

Moreover, the gene expression study was suggestive for regulation of ribosomal proteins. As shown in **Table 5**, a total of 15 ribosomal protein Ls and 6 ribosomal protein Ss were regulated; 4 of them have been already reported as up-regulated in human HCC 17 while 9 of them correlated with c-Myc over-expression [Guo, QM *et.al.*, 2000, Menssen, A *et.al.*, 2002]. To the best of our knowledge, 10 of the ribosomal encoding genes had not been reported so far. Of particular interest is the protein Rpl11 that was identified in 2-D gels (pH 3-10, data not shown); however, the quantitation was not possible due to the difficulty in resolving spots at that high pI (pH>8). For acidic ribosomal proteins regulation was not observed (data not shown).

Overall, 73 regulated proteins in liver tissue (**Figure 24**) have been identified, of which 22 are novel and had not been reported in HCC tissue so far. Based on their biological ontologies, the majority of disease-regulated proteins influence cell cycle, cell growth, differentiation, survival and apoptosis, nucleosome stability, such as histone H2A and ribosomal protein assembly and transport, including nucleophosmin. **Figure 30** depicts ontologies of the regulated mouse tissue proteins, according to Gene ontology.

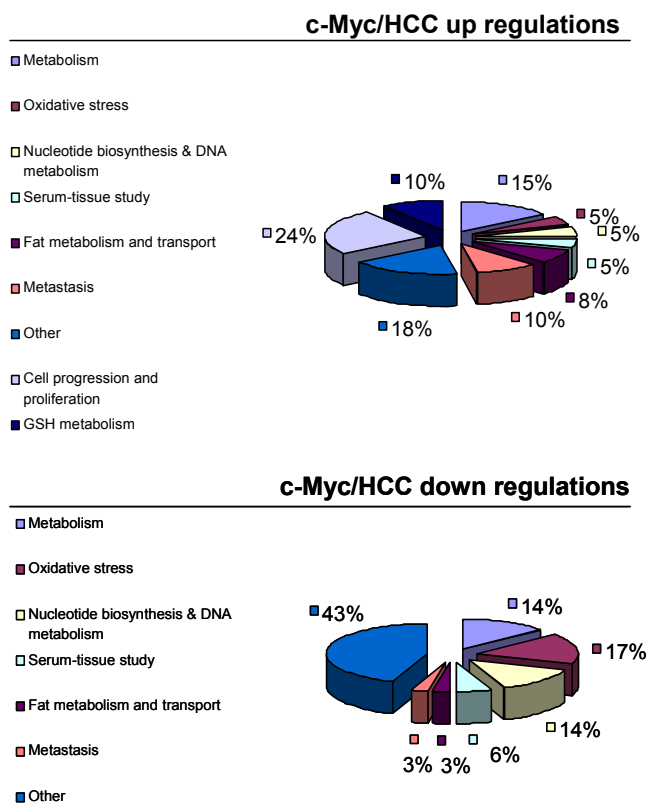

Figure 30: Pie charts from Gene Ontology classification of regulated proteins in mouse liver tissue (tumor vs control) according to the PubGene beta database.

Myc overexpression and hepatocellular carcinoma

Identification of disease regulated proteins in liver tissue

Activation of *c-myc* may be achieved by gene amplification, by chromosomal translocations, beta-catenin co-activation, removal of the 3' UTR destabilizing sequences (elevation of *myc*-mRNA), or co-expression of *ras* which stabilizes the Myc protein by posttranslational modifications. This protein affects cell cycle progression from the G1 to S phase to foster proliferation; metabolism by increasing the cell mass required for the initiation of DNA synthesis (S-phase), and c-Myc redirects energy supply even in hypoxic state of rapid-proliferating cells. Likewise, c-Myc activity may result in genomic instability with high production of reactive oxygen species (ROS) but cells remain recalcitrant to programmed cell death even at high intracellular ROS levels [Greenwood,E, 2002, Pelengaris,S et.al., 2003].

Disease associated regulation of cell cycle proteins

Notably an up-regulation of proteins influencing cell cycle, cell growth, differentiation, survival, apoptosis and migration (such as 14-3-3 protein family), was observed as was regulation of nucleosome stability (histone H2A), ribosomal protein assembly and transport (nucleophosmin) (**Figure 20**). A fine example is an up-regulation of the *elongation factor 1-delta (EF1D)*, a protein recently associated with the cell division cycle 25 (cdc25) phosphatase to influence cell cycle regulation and activity of the 14-3-3 protein family. Up-regulation of EF1D was observed at the mRNA level (Table 3) and this finding agreed well with reports of HCC patients where mRNA of eEF1s was reported to be up-regulated [Chung,EJ *et.al.*, 2002]. Indeed, activity of this elongation factor has been linked to oncogenic transformation [Chung,EJ *et.al.*, 2002, Joseph,P *et.al.*, 2002]. Additionally, an interaction between 14-3-3 epsilon protein and the elongation factor 2 may also influence programmed cell death whereby 14-3-3 redistributes into the perinuclear region, as reported elsewhere [Chung,EJ *et.al.*, 2002, Harris,MN *et.al.*, 2004].

Likewise, the *activator of HSP90 ATPase (AHSA1)*, a co-chaperone of HSP90 that delivers ATP to HSP90, was up-regulated thereby increasing its ATPase activity to function in cell proliferation. Targeting oncogenic proteins by the ubiquitin-proteasome pathway and thus by inhibition of the ATP pocket of HPS90 or by destabilization of the super chaperone complex is a much researched area and of great importance in liver cancer [Pascale,RM *et.al.*, 2005]. Moreover, regulation of AHSA1 was observed in gels at pH ranges 4-7 and 3-10 and to the best of our knowledge, this is the first report for Ahsa1 to be regulated by c-Myc hyperactivity, even though no E-box motifs could be determined in the genomic sequence of the coding gene (**Table 4**).

Likewise, induction of *ubiquitin-carboxyl-terminal hydrolase isozyme L3 (UCHL3)* in HCC of c-Myc transgenic mice is a notable finding. It plays an important role in the release of ubiquitin from an amino-acid complex to regulate essential cellular processes. Dysregulation of de-ubiquitinating enzymes has been observed in multiple disease stages such as aberrant activity of the ubiquitin carboxy-terminal hydrolase L1 (UCH-L1) in cancer and Parkinson's disease [Miyoshi,Y *et.al.*, 2006, Setsuie,R *et.al.*, 2007].

c-Myc induced alterations in cellular metabolism

High capacity proliferation requires increased energy supply and availability of molecular substrates to meet the demand for increased cellular activity. As detailed above and next to an up-regulation of elongation factors such as eEF1-2-3, the induction of peptidyl-prolyl cis-trans isomerase A (PPIA or Rotamase A) by c-Myc is likely to impact cellular mass. Specifically, the elongation factor 1 is responsible for the enzymatic delivery of aminoacyl tRNAs to the ribosome by GTP; here EF-1-beta and EF-1-delta stimulate the exchange of GDP bound to EF-1-alpha to GTP (e.g. guanine nucleotide exchange factors) whereas the isoforms delta and gamma are reported as putative Myc-activated targets ([Watson,JD et.al., 2002], **Table 4**). An up-regulation of the elongation factor 1 (EF1D), as evidenced in the present study, contributes to an understanding of Myc's activity in HCC.

Notably, the peptidyl-prolyl cis-trans isomerase A (PPIA) was already reported to influence refolding of proteins in HCC and for its role in affecting mitochondrial permeability [Lim,SO et.al., 2002].

A further example is the regulation of cytochrome oxidase enzymes in HCC. Specifically, the *cytochrome c oxidase* is a large transmembrane protein complex found in the mitochondria with the ultimate goal to transfer electrons to reactive oxygen to eventually produce water and to establish a transmembrane potential thereby enhancing ATP synthesis. In c-Myc transgenic mice, the *cytochrome b-5-COX5A and COX5B*- were strongly down-regulated to possible suggest impaired mitochondrial energy production. Noteworthy, errors in oxidative phosphorylation was already observed in severe hepatocellular dysfunction [Ederly,P et.al., 1994]. As discussed above, the ability of c-Myc to induce mitochondrial biogenesis in proliferating cells is well established even though inhibition of mitochondrial respiration is observed [Dang,CV, 2010] possible to foster production of other building blocks of growing cells, such as pyrimidines. Recently, a "rethinking" about cancer metabolism and c-Myc's influence has been discussed, with increased mitochondrial biogenesis, deregulation of mitochondrial respiration and increases in glutamine metabolism to foster tumor growth [Dang,CV, 2010].

Besides cytochrome b5, additional mitochondrial enzymes were significantly repressed at the protein level but not at the mRNA level and included the cytochrome b5 outer mitochondrial membrane isoform precursor (CYB5M) and *sulfite oxidase* (SUOX). Notably, the family of cytochrome b5-like proteins consists of a hemoprotein

domain that associates with other redox domains to enable transfer of electrons to cytochrome c. In this regard, Suox, a mitochondrial enzyme located in the inner membrane, catalyzes oxidative degradation of sulphur-containing amino-acids. Activity of this enzyme leads to the production of peroxides whereby Suox catalyzes the reaction: Sulfite + O₂ = sulphate + H₂O₂. The reduction of sulphite to sulphide leads to a strong inhibition of cytochrome c oxidase. Repression of this mitochondrial enzyme prevents apoptosis in HCC [Scheers, I et.al., 2005].

Another mitochondrial enzyme repressed in c-Myc transgenic mice is the *ethylmalonic encephalopathy protein 1 homolog (ETHE1)*. High thiosulfate and sulfide concentrations were reported for Ethe1-ko mice and such sulfides are powerful inhibitors of COX and short-chain fatty acid oxidation to modulate vasoactive and vasotoxic effects. Sulfide is detoxified by a mitochondrial pathway that includes a sulfur dioxygenase and ETHE1 may be considered as a putative *c-myc* target. Furthermore, ROS produced by mitochondrial metabolism may lead to lipid peroxidation to insult mitochondrial DNA (mtDNA) that encodes proteins of the respiratory chain, such as the cytochromes, but unlike genomic DNA, the mtDNA does not contain protective (DNA repair) histones.

In response to high capacity cell division, the protective enzymes NADPH-flavin reductase (BLVRB) and peroxiredoxins were strongly up-regulated in HCC. Recently, *c-myc* was shown to regulate a nuclear gene encoding the mitochondrial peroxiredoxin (PRDX3), which is required for cell proliferation and transformation mediated by *c-myc* [Wonsey, DR et.al., 2002]. In our study, the mitochondrial PRDX3 and the cytoplasmic PRDX6 were overexpressed, possible in response to hypoxia and oxidative stress that is frequently observed in cancers, as detailed below.

Oxidative stress and ROS production

Chronic oxidative stress has been reported to result in increased lipid peroxidation in *c-myc*/TGF induced dysplastic cells with deficiency in DNA repair [Calvisi, DF et.al., 2005b]. While reactive oxygen and peroxides play important roles in cellular signalling, excessive ROS can result in DNA damage. Indeed, peroxides such as H₂O₂ are products from normal cellular processes and are considered as important intracellular messengers for instance to function as hyperpolarization factor in the control of vascular tone. Excessive H₂O₂ can lead to toxic radicals, but efficient mechanisms are in place to scavenge such radicals notably through activity of

antioxidant defence enzymes such as catalase, glutathione peroxidases and peroxiredoxins. These proteins have been reported to be strongly down-regulated in HCC [Irmak,MB *et.al.*, 2003], possible due to the selenium deficiency provoked by oxidative stress. In the present study, Gpx1 and Gpx3 were strongly repressed, while Gpx3 was up-regulated at the gene expression level (**Table 4**). It is well established that selenium is necessary for Gpx activity and deficiency of this mineral leads to apoptosis [Ghose,A *et.al.*, 2001]. In the present study, a significant down-regulation of *selenium-binding protein 1 and 2* at the gene and protein levels was observed but a recent report highlights the ability of HCC cell lines to escape such programmed cell death and to survive in Se deficient medium [Irmak,MB *et.al.*, 2003]. Noteworthy, the *serine/threonine-protein phosphatase 2A (or 2AAA)* was identified as two spots on 2D gels at pH 4-7 with one being repressed (**Table 3**).

As the serine/threonine phosphatases are important in selenite-induced apoptosis, our study supports the hypothesis that such phosphatases are regulated in c-Myc-induced cell growth.

Further possibilities to detoxify ROS are based on the activity of peroxiredoxines (Prxs). These enzymes are abundant in cytosol (Prx 1,2,6) and in mitochondria (Prx 3). They function without Se and cycle thiol and sulfinic acids, which uses thioredoxins, thioredoxin reductase and sulfinic reductase but not glutathione (as Gpx) or glutaredoxin to reduce the disulfide binding. In c-Myc transgenic mice induction of thioredoxin was observed (data not shown) but glutaredoxin was not regulated. As Prdxs have been proposed to function as *chaperones for Prdx-SO₄*-their up-regulation in tumor tissues may contribute to ROS detoxification.

Further evidence for oxidative stress in HCC stems from the low expression of the protein DJ-1 in HCC of c-Myc transgenic mice. Reduced expression of this oxidative stress sensor suggests abnormal function of mitochondria [Hao,LY *et.al.*, 2010]. In support of its function, loss of DJ-1 activity leads to deficiency in NADH-ubiquinone oxidoreductases. This agrees well with our observation of reduced expression of the mitochondrial NADH-ubiquinone oxidoreductase 75kDa subunit (NUAM) and the mitochondrial NADH dehydrogenase iron-sulfur protein 3 (NUGM) in HCC bearing transgenic mice (**Table 4**).

A further mechanism to prevent ROS insult is linked to glutathione metabolism. Here 5-oxo-proline, that is one of the five enzymes of the gamma-glutamyl cycle, was down-regulated, whilst glutamate-cystein ligase (GSH0) and GSH S-transferase

(GSTM1) were up-regulated. This can be explained by the self-renewal of glutamate by the gamma-glutamyl cycle and the reduction of GSH-reductase by cytosolic isocitrate dehydrogenase which was also up-regulated in our study. Its induction in rapidly growing hepatocytes was already reported [Tsuboi,S, 1999].

Nucleotide biosynthesis and DNA metabolism

As cells enter the S phase, adequate substrates must be made available to ensure the fidelity of DNA replication. Several genes important in nucleotide biosynthesis and DNA metabolism are targeted by c-Myc and were regulated in tumor tissue of transgenic mice. This included carbamoyl phosphate synthase and ornithine decarboxylase. Carbamoyl phosphate is the first molecule in the pyrimidine biosynthesis (in cytosol) and the urea cycle located in the mitochondria. Deficiency in the complete urea cycle converts ammonia into *glutamine* to cause cellular proliferation [Rhoads, JM et.al., 1997]. This agreed well with the more than 4-fold increase of protein expression (**Table 4**) and the more than 9-fold up-regulation of glutamine synthetase mRNA (data not shown), a finding that has also been observed in other HCC studies [Kuramitsu, Y et.al., 2006]. Again, up-regulation of glutamine metabolism fits well with the “re-thinking” in cancer metabolism [Dang, CV, 2010]; the ASCT2, a gene involved in glutamine transport to be strongly up-regulated (T/C: 8.499, p=0.0009) also observed, thereby providing further evidence for c-Myc’s concerted action in nucleotide biosynthesis and DNA metabolism.

Furthermore, mitochondrial carbamoyl-phosphate synthase (CSPM), mitochondrial ornithine carbamoyltransferase (OTC) as well as arginase I (ARG1) were down-regulated at the mRNA and at the protein level (**Table 4**); this highlights low functional activity of the urea cycle in liver cancer, as previously discussed [Butler, SL et.al., 2008]. A decreased activity in the urea cycle allows cancer cells to utilize substrates such as carbamoyl phosphate and ornithine for pyrimidine synthesis and polyamine biosynthesis as such molecules are required in high abundance in proliferating cells.

Strong up-regulation of ornithine aminotransferase (OAT), which uses glutamine as substrate to foster purine/pyrimidine synthesis, was also observed. In fact, tumor cells need large amounts of dTMP for DNA synthesis. Here the 10-formyltetrahydrofolate dehydrogenase is a rate limiting enzyme in folate synthesis and was shown to be

strongly down regulated in several cancers. Our results had also confirmed low expression of the protein in HCC transgenic mice.

Lipid metabolism and transport

Lipid metabolism is greatly changed in cancers. Enhanced fat synthesis in tumor cells supports increased membrane synthesis and energy metabolism. A relationship between HCC and lipid metabolism has been argued that included regulation of ApoA1 and ApoE as previously reported [Gray,J *et.al.*, 2009, Yokoyama,Y *et.al.*, 2006]. In the present study, the liver fatty acid-binding protein (FABPL) was strongly repressed. This protein carries fatty acids and other lipophilic substances such as eicosanoids and retinoids to facilitate the transfer of fatty acids between extra- and intracellular membranes. Some family members are also believed to transport lipophilic molecules from outer cell membrane to certain intracellular receptors such as PPAR. Noteworthy, numerous studies revealed PPAR α and PPAR γ agonists to exert anti-inflammatory effects and for PPAR γ antagonist to inhibit growth of cells. Thus PPAR γ antagonists are explored for their therapeutic efficacy in liver cancer. A further mitochondrial enzyme regulated in HCC is *3-hydroxyisobutyrate dehydrogenase*. This enzyme is involved in amino acid degradation. It regulates the last step towards ketone production. Normally, the ketone bodies are synthesized by the Acetyl-CoA when there is an excess of lipid degradation. Previously, Thompson and colleagues reported that inhibition of a key enzyme linking glucose metabolism to lipid synthesis suppresses tumour growth [Hatzivassiliou,G *et.al.*, 2005]; aberrations in lipid metabolism have already been reported in patients with the chronic hepatitis B infection, leading to HCC [Jiang,JT *et.al.*, 2006].

In the present study a more than 4-fold up-regulation of cathepsin B was evidenced. This lysosomal cysteine proteinase is composed of a dimer of disulfide-linked heavy and light chains and it is significantly elevated in a variant of the B16 melanoma with high metastatic potential. Recent studies, however, emphasized low expression of cathepsin B [Li,C *et.al.*, 2004] and that the protein is repressed by *c-myc*. In the present study the opposite was observed and may possible be linked to an activation of Miz-1 that heterodimerises with c-Myc to repress activity of targeted genes.

Likewise, the *MIR-interacting saposin (MSAP)* was recently reported to be associated with metastasis; it is a positive regulator of neurite outgrowth by stabilizing myosin regulatory light chain (MRLC) to prevent MIR-mediated MRLC ubiquitination and its

subsequent proteasomal degradation. In the present study, a more than 5-fold up-regulation of this protein was observed in conjunction with an 3.5-fold up-regulation of the Rho GDP-dissociation inhibitor 1 (GDIR, chaperone family) and an 3-fold up-regulation of the chloride intracellular channel protein 1 (CLIC1) to provide further evidence for its disease driven regulation and to possible foster metastatic spread.

Ribosomal biosynthesis

Myc is a global regulator of various cell processes [van Riggelen, J *et.al.*, 2010]; recently, its contribution in tumorigenesis through the modulation of ribosome biogenesis has been discovered [van Riggelen, J *et.al.*, 2010]. Indeed, ribosome biogenesis and protein translation are inter-linked to determine cell fate. Ribosome biogenesis requires the synthesis and the assembly of several ribosomal proteins (RPL and RPS) [van Riggelen, J *et.al.*, 2010], which are synthesised in the cytoplasm, then imported into the nucleus and assembled into small and large ribosomal units. So far, few of them have been reported as increased in human cancers while some are considered targets of c-Myc. In the present study, the microarray analysis (see **Table 5**) identified most of the genes encoding for ribosome proteins to be up-regulated. In agreement with the processing of rRNA precursors for ribosomal assembly, as well as transport of mature ribosomal units, nucleophosmin (**Table 6**) and nucleolin (only at the mRNA level) were up-regulated.

Translational research into human HCC

In general, candidate biomarkers for malignancy should be accessible in bio fluids, such as blood and urine, for non-invasive diagnosis. As discussed earlier [Ritorto, MS *et.al.*, 2008] the zooming of 2-D gels allowed better resolution of spots thereby avoiding co-migration of proteins. Thus, high molecular weight proteins are well resolved by trains of spots and permitted identification of phosphatidylinositol-glycan-specific phospholipase D, polymeric immunoglobulin receptor, some isoforms of major urinary protein as well as hemopexin to be statistically significantly regulated. Unlike with gels at pH 3-10, good sequence coverage, i.e., up to 77% was obtained from in-gel digest at pH 4-7 that also permitted in-depth tandem MS analysis (**Table 2**). Overall, 17 highly regulated serum proteins were identified. A notable finding was the identification of the secretory component of the polymeric immunoglobulin receptor (SC-PIGR), as well as the up-regulation of phosphatidylinositol phospholipase D (PHLD) and the down-regulation of afamin (AFM) in serum of

human HCC. Specifically, the secretory component of PIGR is the extracellular cleaved part of this receptor and known to be responsible for the transcytosis of plgA to achieve mucosal immunity. In liver this protein is secreted at the apical surface of the polarized hepatocytes toward the bile ducts and it has been reported that PIGR plays a role in viral liver disease possibly facilitating infection of hepatocytes by HAV [Dotauer,A *et.al.*, 2005]. Regulation of SC-PIGR is a novel finding which brings to hypothesize that this protein may likewise facilitate viral infection of other DNA and RNA viruses.

Furthermore, the PHLD (known also as GPI-PLD) is an important enzyme for modifications of GPI-anchored proteins of the plasma membrane. Its role in liver cancer remains enigmatic [Jian-Hua,T *et.al.*, 2009, Rhode,H *et.al.*, 1999] but may serve as biomarker candidate as discussed for glypican-3 and CEA, which are GPI-anchored proteins as well and are the subject of a separated report (Ritorto *et al. in preparation*).

The similarity in regulation of plasma retinol binding protein 4 (RET4) and transthyretin (TTHY) in sera and liver tissue extracts attracted our attention. Notably, retinol-binding protein is the retinol (vitamin A) specific carrier, which circulates in blood as a 1:1 complex with the homotetrameric protein transthyretin (TTHY). Both RET4 and TTHY are synthesized and secreted by the hepatocytes. The binding with TTHY increases the molecular weight of RET4 and thus prevents its glomerular filtration and catabolism in the kidney. Importantly, dysfunctions of the liver and kidneys are known to influence RET4 homeostasis [Wu,HY *et.al.*, 2008].

The retinol-binding protein has already been associated with ovarian and lung cancer [Stephensen,CB *et.al.*, 2000, Um,SJ *et.al.*, 2001]. Likewise, proteomic studies conducted in our laboratory had shown earlier increased expression of RET4 in serum of SPC-myc transgenic mice that develop lung cancer [Chatterji,B *et.al.*, 2009] but not in SPC/c-Raf transgenic mice [Chatterji,B *et.al.*, 2007], which developed lung cancer as well. In an EGF-transgenic mouse model of liver cancer [Gazzana,G *et.al.*, 2008], RET4 was not regulated therefore suggesting this protein to be a good diagnostic marker for c-Myc associated carcinogenesis. Other groups had shown that over-expression of N-myc in a neuroblastoma cell line with no endogenous N-myc expression caused a marked reduction in retinoid-induced growth inhibition [Goodman,LA *et.al.*, 1997].

Diabetes appeared to enhance c-myc expression (ref) and, indeed, up-regulation of RET4 only in HCC patients with diabetes and alcoholic steatosis was observed (*Chart 2*).

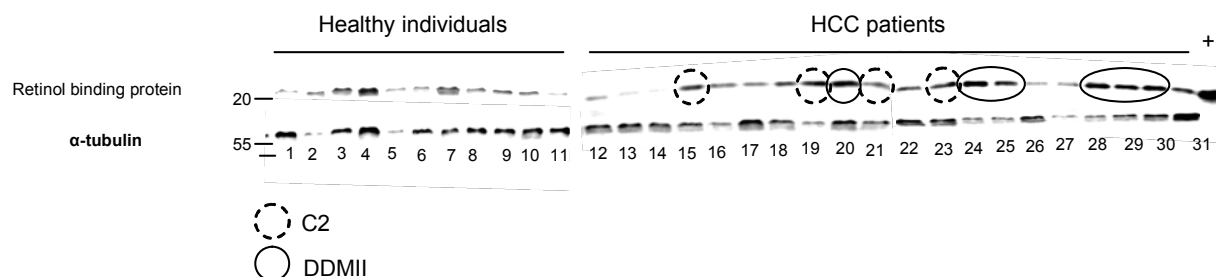

Chart 2: Western immunoblotting of sera from a cohort of 31 patients. The RET4 was up-regulated only in cases of alcoholic steatosis (C2) and diabetes mellitus type II (DDMII) (circled parts). The α -tubulin was used as loading control, whilst HepG2 cell extracts as positive control (+)

Taken collectively, RET4 should be considered as a biomarker of c-Myc induced HCC. Further evidence stems from our genomic studies where significant down-regulation of ATRA reductase, the enzyme involved in the metabolism of retinol was observed (data not shown). Co-regulation of transthyretin (*transports thyroxine and retinol* also called pre-albumin, due its chromatography behaviour) is another important finding since it forms a complex with RET4 to prevent RET4 glomerular filtration. High expression of these proteins in mouse and human liver tissue (**Table 4**) provided strong evidence for its value in disease diagnostics and appears to be particularly regulated in patients diagnosed with HCC and insulin resistance.

A further disease regulated proteins are *major urinary proteins* (MUPs). Notably, MUPs are predominantly secreted from the liver. Structurally, they belong to the lipocalin family, which carries small hydrophobic ligands such as pheromones. As of today, the physiological functions of MUPs remain poorly understood. However, this study is the first report on their regulation in human beings, albeit at different levels when individual MUPs are composed. Specifically, there is evidence for MUP-1 to be an important player in regulating energy expenditure and metabolism in mice [Zhou, YJ *et.al.*, 2009]. At the molecular level, MUP-1-mediated improvement in metabolism was accompanied by increased expression of genes involved in mitochondrial biogenesis, elevated mitochondrial oxidative capacity, and decreased triglyceride accumulation. Consequently, MUP-1 deficiency contributes to metabolic dysregulation in obese/diabetic mice. In c-Myc transgenic mice, MUP gene and protein expression was significantly repressed in both serum and liver (**Table 6**).

Results on human liver tissues showed, however, strong cytoplasmatic and nuclear up-regulation of MUP in HCC patients (**Figure 29**), therefore demonstrating species dependent regulation.

Significance of the present study

Several proteins identified in the present study are novel and have not been associated with HCC as yet. This includes an up-regulation of *galactokinase (GALK1)* which catalyzes the phosphorylation of the galactose to galactose 1-P. It is known that galactose 1-P is the precursor of UDP-galactose, a nucleotide sugar important in activation of purigenic receptors. UDP-glucose plays an important role in glycosylation reactions. Moreover, the UDP-sugars are high-donor substrates in biosynthetic reactions, which are released from cells for signalling [Viola,M et.al., 2008]. The question remains whether GALK1 induces production of UDP-galactose. Note in this study regulation of any of the urydiltransferase enzyme was detected but it may be an index of galactosemia, i.e. the inability to use galactose for energy production, to possible impact HCC disease progression.

A further example is the down-regulation of the *indolethylamine N-methyltransferase (TEMT)* which catalyzes the N-methylation of tryptamine and structurally related compounds. This protein is more than 2-fold down-regulated in the genomic and proteomic studies and may result in aberrant methylation of regulatory molecules frequently observed in malignancies.

Likewise, the present study identified *phosphatidylethanolamine-binding protein 1 (PEBP1 or RKIP)*, due to its inhibition role in Raf/MEK/ERK cascade) as strongly up-regulated in HCC bearing mice. Hepatocellular carcinoma cell lines and HCC liver tissue showed decreased RKIP expression as compared to primary human hepatocytes or adjacent peritumoral tissues. Low RKIP expression was correlated with increased ERK activation and modulation of RKIP expression to antagonize MAPK signaling in vitro [Yeung,K et.al., 2000]. Note, Pebp is considered to be a Myc target [Kuystermans,D et.al., 2010] but in this study only a slight up-regulation of the *Pebp1* gene (T/C=1.55, p=0.06) was recorded. Thus, its regulation appears to be post-translational.

The strong point of our study is the confirmation of regulated proteins identified in a c-Myc transgenic mouse model into human HCC. Indeed, translational research of specific proteins in HCC patients highly helps to overcome the variability in human samples and focusing on specific targets in liver cancer.

As well known, several concomitant diseases or alterations are correlated to cancer development in humans. In this study, HCC patients were divided in different groups, related to different concomitant diseases (such as diabetes, alcoholic steatohepatitis, chronic viral infections).

For instance, the regulation of secretory component of the polymeric immunoglobulin receptor (SC-PIGR) could be trace back to specifically chronic Hepatitis C/ HCC patients; whilst the serum GPI-PLD was reported over-expressed mostly in HCC patients with concomitant non-alcoholic steatohepatitis (NASH). On the other hand, the expression of retinol binding protein and the transthyretin was correlated to diabetes and alcoholic steatohepatitis in human HCC. Moreover, an opposite regulation of hemopexin in either serum or tissue was observed in our transgenic mice and confirmed in human HCC by Western blot (WB) and immunohistochemistry (IHC), respectively.

Comparison of genomic and proteomic studies of gene products in c-Myc transgenic mice, revealed that regulation of candidate biomarkers in cancer may often occur at a post-transcriptional level. For example, the GPI-PLD and the SC-PIGR were not statistically regulated at the gene level and an approach based only on genomic study would have left those proteins out of human validations as candidate biomarkers for HCC. Serum proteomics has the potential to give direct answer for possible candidate biomarkers to screen in bio fluids, avoiding highly invasive approaches, such as biopsy.

Perspectives

Over the last two decades significant progress has been made in an understanding of *c-myc* function in normal and cancer cells. In the present study a c-Myc protein map was constructed suitable for diagnostic and possible therapeutic intervention strategies. Furthermore, disease associated regulation of some proteins in human serum and tissue was achieved therefore validating findings from a disease mouse model in human HCC. More than 29% of identified proteins had already been reported as c-Myc targets. The newly identified proteins enable a better understanding of c-Myc in HCC and function in diverse biological processes compatible with the versatile activity of c-Myc.

Part 3:

- Investigate the role of GPI-phospholipase D in liver cancer

This part of the doctoral work is also included in an article in preparation:

“Induction of the GPI-specific phospholipase D signalling in a c-Myc transgenic mouse model of hepatocellular carcinoma”

Maria Stella Ritorto, Heidrun Rhode and Jürgen Borlak

Background

One of the candidate biomarker identified by us in the c-Myc mouse model of HCC was the GPI-specific phospholipase D (GPI-PLD). Notably, glycosylphosphatidylinositol-specific phospholipase D (Gpld1) codes for an 815-amino acid protein (GPI-PLD) that is widely expressed in tissue and human serum [Chalasan,N et.al., 2006]. Indeed, the liver is the main source of serum GPI-PLD [Rhode,H et.al., 2000]. This protein differs, however, when expressed in tissue or serum and several putative inhibitors of serum activity have been reported [Low,MG et.al., 1993, Rhode,H et.al., 2000]. Furthermore, high expression of serum GPI-PLD has been attributed to disorders of lipid metabolism and atherosclerosis [Deeg,MA et.al., 2001a], as well as insulin resistance and NASH [Chalasan,N et.al., 2006]. Changes in mRNA expression of GPI-PLD has also been reported for different human cancers [Foster,DA, 2006, Hui,L et.al., 2005, Zheng,Y et.al., 2006] including HCC [Jian-Hua,T et.al., 2009], but an evaluation of GPI-PLD activity in serum of c-Myc transgenic mice and an evaluation of c-Myc's role in the regulation of the GPI-anchored proteins (GPI-APs) is still lacking behind, even though a possible link between estrogens and phospholipase D1 (PLD1) was reported to be dependent on c-Myc in MCF-7 breast cancer cell line [Rodrik,V et.al., 2005]. While c-Myc's role in survival signalling is well established [Joseph,T et.al., 2002, Rodrik,V et.al., 2005, Shi,M et.al., 2007], the role of GPI-PLD in c-Myc induced carcinogenesis is less clear and possible confounded by additional factors, such as NASH, diabetes mellitus type II (DDMII), alcohol abuse (C2) or chronic viral infection (HCV/HBV) as observed in the present study. Indeed, activity of serum GPI-PLD was clearly linked to the complexity of disease and was most pronounced in patients diagnosed with NASH. While the c-Myc transgenic mouse model enabled in vivo mechanistic studies, cultures of human hepatocytes under conditions of NASH were employed to investigate GPI-PLD activity, as well as transcriptional responses of other GPI-APs. A comparison of data from the transgenic mouse model and human hepatocytes as well as activity measurements of GPI-PLD provide evidence for GPI-PLD to stabilize c-Myc protein and to

sustain c-Myc activity. Specifically, repression of the serine/threonine phosphatase 2A (2AAA_MOUSE) was observed. This phosphatase dephosphorylates the c-Myc protein which is then dressed up by the ubiquitination system for its degradation by the ubiquitin-proteasome pathway and it is known to be inhibited by PLD. Evidence is therefore presented for the GPI-PLD to stabilize c-Myc protein and activity. Furthermore, certain lipoproteins, such as ApoA1, ApoE and the paraoxonase-1 (PON1) were significantly regulated in sera of transgenic mice. Notably, ApoE and PON1 were specifically up-regulated in HCC/NASH patients (Ritorto et al, submitted) and are known to stabilize activity of GPI-PLD.

Taken collectively, this study reported a novel role of GPI-PLD in HCC and the importance of this phospholipase in the regulation of c-Myc mRNA and protein expression of serum GPI-PLD in c-Myc transgenic mice and HCC patients.

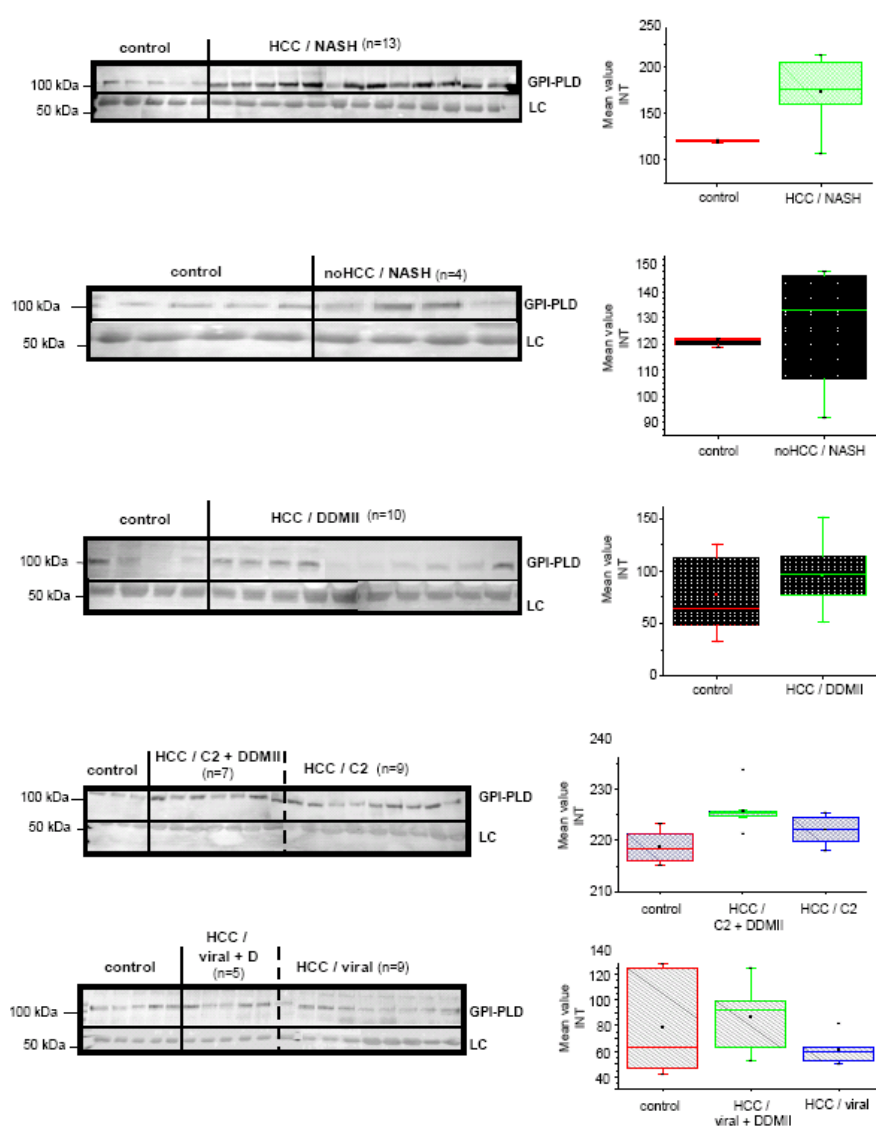

Figure 31: Western blot for the GPI-PLD expression in sera from HCC patients with different concomitant disease (C2: alcoholic steatohepatitis; DDMII (D): diabetes mellitus type II; viral: HCV/HBV chronic infections; NASH: non-alcoholic steatohepatitis). Sera from patients with NASH but not HCC were also analysed. LC: loading control.

mRNA and protein expression of serum GPI-PLD in c-Myc transgenic mice and HCC patients

By Western immunoblotting expression of GPI-PLD was measured in liver and serum of n=9 mice at the age of 6 and 12 months and in n=52 patient sera. Notably, this patient cohort consisted of HCC patients diagnosed with either NASH (n=13), diabetes mellitus type II (DDMII, n=10), ethyl-toxic steatohepatitis (C2, n=16) and chronic viral liver disease (HCV/HBV, n=13). Additionally, expression of GPI-PLD was measured in NASH patient sera without liver cancer (n=4) and compared to n=10 healthy controls. As shown in Figure 1A the expression of serum GPI-PLD differed amongst patients and depended on the disease, with GPI-PLD expression being high in NASH (92%) and C2 + DDMII (86%) patients but low in chronic viral liver disease. Moreover, in c-Myc transgenic mice expression of serum GPI-PLD increased with time being 5-fold up-regulated, when compared with healthy non-transgenic controls (**Figure 31**).

In contrast, *Gpld1* gene expression was significantly reduced in liver tissue of transgenic mice and human hepatocyte cultures under conditions of NASH (**Table 7**). The *Gpld1* as well as *Pld1* itself were slightly reduced in both HCC mice and cultures of human hepatocytes, being statistically significant ($p=0.012$) only for *Pld1* in 12 months old mice, while *Gpld1* was significantly reduced ($p=0.034$) in cultures of human hepatocytes (**Table 7**).

GPI-PLD enzyme activity

GPI-PLD is a secreted mammalian enzyme that specifically cleaves GPI-anchored proteins (**Figure 32**). In addition, the enzyme has been shown to cleave GPI anchor intermediates in cell lysates.

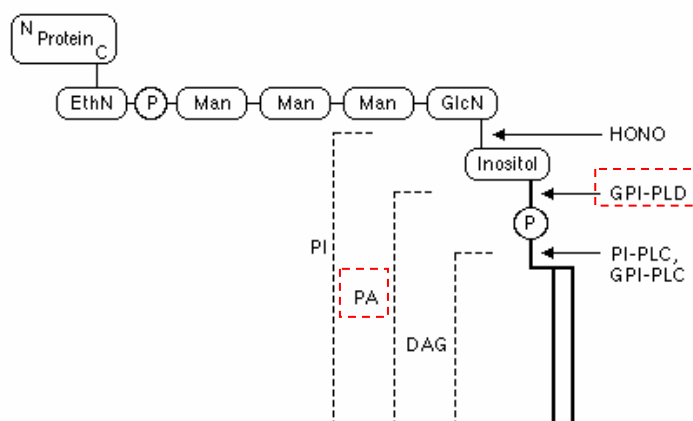

Figure 32: Cleavage site for the phospholipases. The GPI-PLD cleaves exactly the inositol-P, releasing specifically the phosphatidic acid (PA).

Serum GPI-PLD cleaves the GPIs (free GPIs or GPI-anchored proteins) in a specific manner, producing phosphatidic acid (PA). PA is a critical component of mTOR signalling and mitogenic stimulation of mammalian cells leads to a phospholipase D-dependent accumulation of cellular PA, which is required for activation of mTOR downstream effectors [Fang, YM *et.al.*, 2001]. Indeed, PA directly interacts with mTOR that is targeted by rapamycin, and this interaction is positively correlated with mTOR's ability to activate downstream effectors. The involvement of PA in mTOR signaling reveals an important function of this lipid in signal transduction and protein synthesis, as well as a direct link between mTOR and mitogens. Moreover, LPA, a metabolite of PA, stimulates tumor angiogenesis through activation of the c-Myc and Sp-1 transcription factors [Song, YD *et.al.*, 2009].

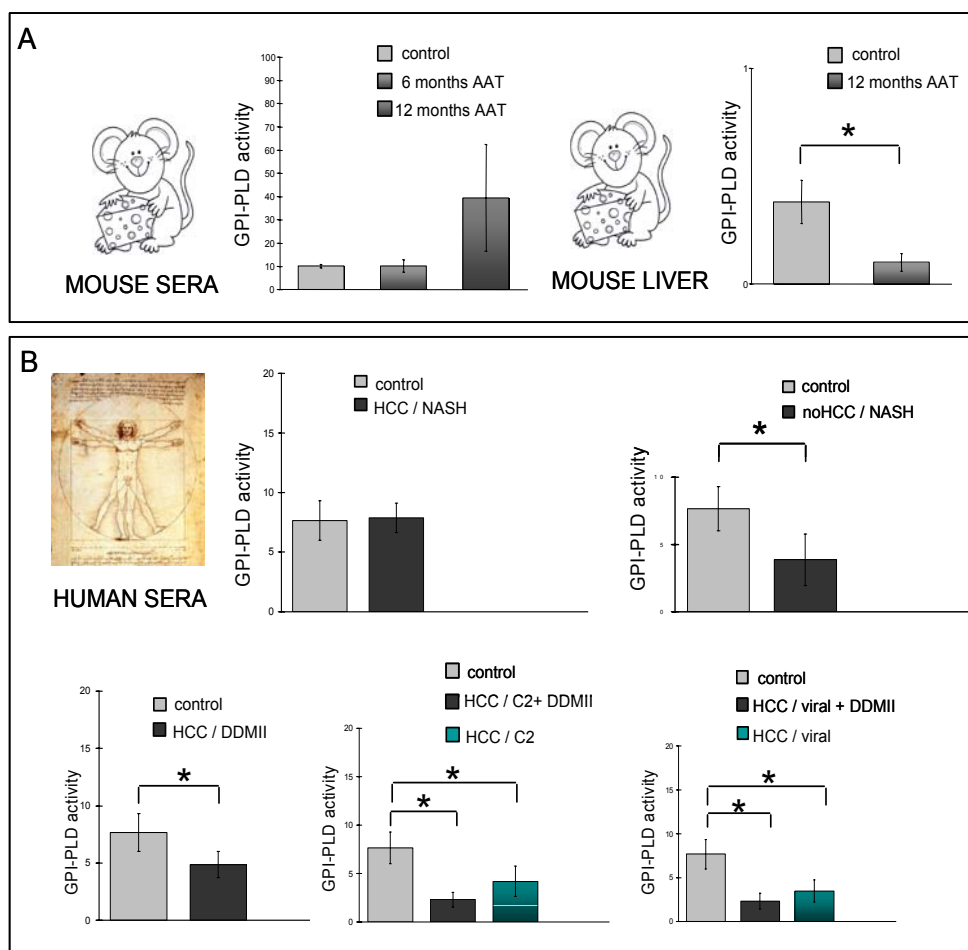

Figure 33: Measurement of GPI-PLD activity (=release of alkaline phosphatase from substrate) in mouse sera (A) and in liver tissue (B) of HCC mice and human, respectively.

The phosphatidic acid phosphatase 2A (PPAP2A) is an enzyme that catalyzes the conversion of phosphatidic acid (PA) to diacylglycerol (DG). Importantly, in the present study the Ppap2a gene expression was repressed in HCC mice (T/C=0.24, p=0.0007) and NASH hepatocytes (T/C=0.5, p=0.098).

c-Myc stabilization

Stabilization of c-Myc is at least in part dependent upon mTOR activity and two upstream activators of mTOR that is PI3K and PLD. While in the present study no major regulation of *Pld1* and *Gpld1* coding genes was observed, other specific

checkpoints in Myc stabilization need to be considered that suppress ubiquitination and degradation of Myc by the proteasome through Gsk3 β and PLD. In this regard, the serine/threonine phosphatase 2A (PP2A) plays a key role in the dephosphorylation of Myc at Ser62 and in the further dressing of c-Myc to enhance proteasomal degradation [Rodrik,V et.al., 2006]. PLD is the only enzyme, known to suppress PP2A. In our previous research on AAT-c-Myc transgenic mice, the serine/threonine protein phosphatase 2A was shown to be strongly down-regulated. Furthermore, Chalasani and co-workers demonstrated that over-expression of GPI-PLD repressed expression of the orthologue gene in the human hepatoma cell line, HepG2. In the present study, down-regulation of this gene was also observed in cultures of primary human hepatocytes.

The activity of PLD1 is regulated by several factors and include the small GTPases notably members of Rho- and Ral-family of GTPases. Specifically, the Rho-family GTPases play a critical role in the regulation of PLD activity in cell migration, as evidenced in stress fibres [Deeg,MA et.al., 2001b] and modulation of its activity by RalA [Liscovitch,M et.al., 2000]. Recent research in the c-Myc transgenic model of liver cancer identified the Rho GDP-dissociation inhibitor 1 to be 3-fold up-regulated in HCC mice. A similar regulation of the GDP/GTP exchange and of RalA was observed at the gene expression level in HCC mice. However, RalA alone is not sufficient to activate PLD1 [Foster,DA et.al., 2003].

There is growing evidence for PLD to play essential role in survival signalling in cancer cells that carry mutations in Raf [Joseph,T et.al., 2002], Ras [Shi,M et.al., 2007] or display hyperactivity of c-Myc [Rodrik,V et.al., 2005] due to oncogenic Raf/Ras signalling [Kerkhoff,E et.al., 1998] (**Figure 33**).

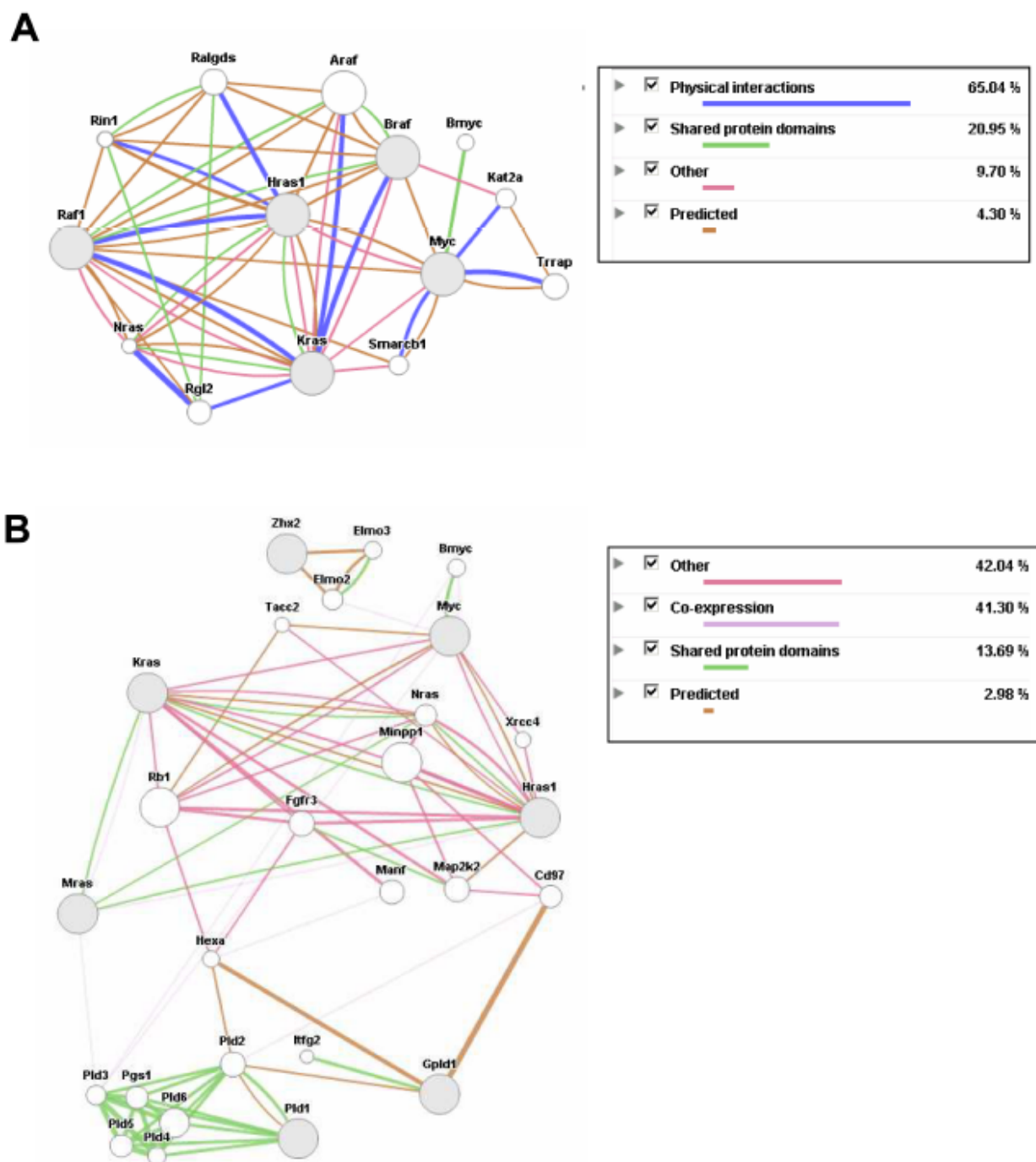

Figure 33: Interactions among Myc, Raf/Ras family (A) and PLD family (B). Data collected from GeneMANIA.

In the present study the Raf kinase inhibitor protein, Pebp1 (also termed RKIP) was significantly up-regulated. Notably, PLD overcomes cell cycle arrest induced by high intensity Raf signalling [Joseph,T et.al., 2002].

One of the most corroborate inhibitors of GPI-PLD is PA [Low,MG et.al., 1993]. Indeed, GPI-PLD isolated from plasma or serum is unable to release GPI-APs directly from the surface of intact mammalian cells, probably due to the presence of inhibitors, such as PA or LPA [Du,XH et.al., 2001]. However, inhibition of the protein phosphatase 1 (PP-1) has been specifically associated with PA in neurons [Plummer,G et.al., 2005]. The present work on HCC mice showed strongly up-regulation of Ppp1r14b gene even at early stages of disease (**Table 7**). The Ppp1r14b is a gene, which codify for a strong inhibitor of PPP1CA (Pp-1c); on the other hand, phosphatidic acid is a very selective inhibitor of PP-1c.

High [PA] leads to inhibition of GPI-phospholipase D. Down-regulation of Gpld1 in mouse liver tissues and human hepatocytes was indeed reported, but the activity of GPI-PLD was high in serum and very low in tissue. That brings to the suggestion that PA may concentrate in tissue after release in serum produced by serum GPI-PLD, might pass through a perturbed membrane (through possible membrane diffusion or perturbation) and act in the cell on the phosphatases blocking apoptosis [Plummer,G et.al., 2005] and leading to c-Myc stabilization directly.

HDL particles and serum GPI-PLD

HDL plays a key role in the cholesterol transport pathway and has become a therapeutic target in liver diseases [Jiang,JT et.al., 2006]. Importantly, GPI-PLD associates with ApoA-I (Lp[A-I]), ApoA-IV (Lp[A-I, A-II]) of the HDL particle but not with ApoC2, ApoC3 and ApoE [Deeg,MA et.al., 2001b]. Regulation of these lipoproteins in HCC and NASH has been reported [Chalasani,N et.al., 2006, Jian-Hua,T et.al., 2009]. Specifically, GPI-PLD is mostly found in Lp[A-I]) particles [Deeg,MA et.al., 2001b]. Interestingly, paraoxonase interacts with Lp[A-I] as well and Apo A-I acts as a repository for Apo E that is required in the metabolism of chylomicrons and VLDL; in the study of Ooi et al [Ooi,K et.al., 2005] slow alpha HDL appeared during bile stagnation and eventually metastatic liver cancer, accompanied by increased ApoE levels.

In the present study, Gpld1 was not regulated at the gene level, while our recent research identified ApoE protein expression to be strongly up-regulated in sera of HCC mice as well as human HCC (*Ritorto et al, submitted*). Moreover, increased expression of serum paraoxonase 1 was observed in c-Myc transgenic mice with advanced disease and in HCC/NASH patients (*Ritorto et al, submitted*).

Thus, the recently identified regulation of ApoA-I and ApoA-II in HCC of c-Myc transgenic mice can now be linked to the activity of GPI-PLD and its survival signalling. ApoA-I participates in the reverse transport of cholesterol from tissues to the liver for excretion thereby promoting cholesterol efflux from tissues and by acting as a cofactor for the lecithin cholesterol acyltransferase (LCAT). At the gene level, LCAT was down-regulated in 2 months (1.5 fold, $p=0.02$), 6 months (1.6 fold, $p=0.02$) and 12 months (2 fold, $p=0.0005$) old c-Myc transgenic mice. Likewise, a similar down-regulation of LCAT (1.60 fold, $p=0.1$) was observed in cultures of human hepatocytes under conditions of NASH (**Table 7**).

Altogether, this suggests a complex interplay of GPI-PLD and apolipoproteins in HCC and NASH with recent literature linking obesity, diabetes mellitus, NASH to risk for HCC based on the “first hit” theory postulated for progression of steatosis to NASH and cirrhosis, the irreversible step toward HCC. Indeed, the present study with cultures of human hepatocytes evidences regulation of genes observed by over-expression of GPI-PLD [*Chalasan, N et.al., 2006*] that were similarly to findings of HCC in c-Myc transgenic mice. Reduced levels of serum (but not mRNA) GPI-PLD after statin therapy corroborates our results [*Deeg, MA et.al., 2007*].

Perspectives

This preliminary study on the function of GPI-PLD in liver cancer after c-Myc over-expression suggests a pivotal role of this phosphatase in cancer.

The [PA] in tissues seems the key in understanding the lacking connection between serum activity of GPI-PLD and liver dysfunction under over-expression of c-Myc. Moreover, it may help also in understanding the significance of high serum GPI-PLD in HCC/NASH, which leads to considered serum GPI-PLD as main strength in early detection of HCC and NASH.

Conclusions

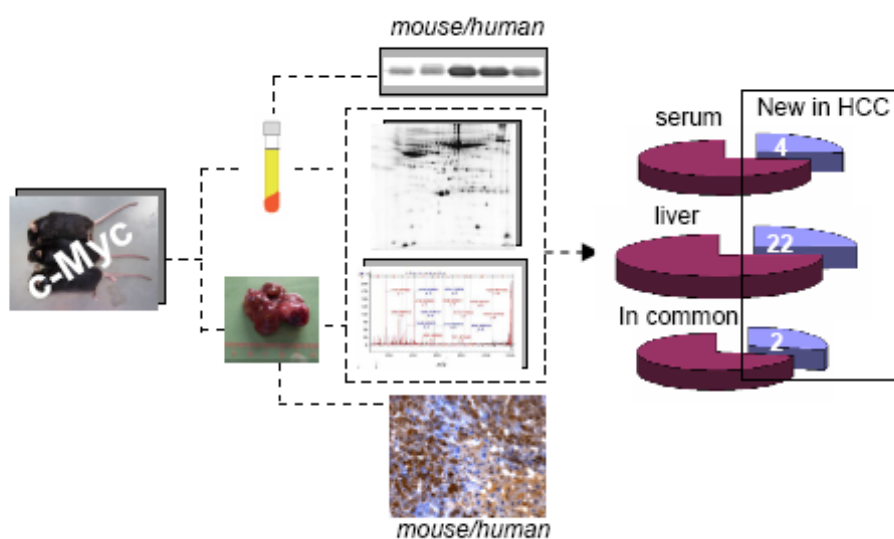

Based on different experimental strategies, an improved method for the identification of proteins was developed and applied to the serum and the liver tissue of c-Myc transgenic model of HCC.

A total of 28 novel disease regulated proteins were identified of which two were regulated in both “compartments” (namely, retinol binding protein 4 and transthyretin).

Knowledge on these proteins helps to better define the role of c-Myc in liver cancer; indeed, some of them were validated for human HCC, carrying the hope for early detection of disease and improvement of disease management, under specific conditions. In fact, translational studies of the GPI-PLD expression and activity in sera from HCC mice into HCC patients showed specific regulation of this enzyme in HCC patients with concomitant non-alcoholic steatohepatitis (NASH), suggesting a role of c-Myc in HCC induced by NASH.



Font: Companionsoftware

Bibliography

- Adhikary,S, Marinoni,F, Hock,A, Hulleman,E, Popov,N, Beier,R, Bernard,S, Quarto,M, Capra,M, Goettig,S, Kogel,U, Scheffner,M, Helin,K, & Eilers,M,"*The ubiquitin ligase HectH9 regulates transcriptional activation by myc and is essential for tumor cell proliferation*". Cell, **2005**;123, 409-421.
- Aebersold,R & Mann,M,"*Mass spectrometry-based proteomics*". Nature, **2003**;422, 198-207.
- Alexandrescu,DT, McClure,R, Farzanmehr,H, & Dasanu,CA,"*Secondary erythrocytosis produced by the tyrosine kinase inhibitors sunitinib and sorafenib*". Journal of Clinical Oncology, **2008**;26, 4047-4048.
- Amati,B, Dalton,S, Brooks,MW, Littlewood,TD, Evan,GI, & Land,H,"*Transcriptional Activation by the Human C-Myc Oncoprotein in Yeast Requires Interaction with Max*". Nature, **1992**;359, 423-426.
- Anderson,GR,"*Genomic instability in cancer*". Current Science, **2001**;81, 501-507.
- Arango,D, Mariadason,JM, Wilson,AJ, Yang,W, Corner,GA, Nicholas,C, Aranes,MJ, & Augenlicht,LH,"*c-Myc overexpression sensitises colon cancer cells to camptothecin-induced apoptosis*". British Journal of Cancer, **2003**;89, 1757-1765.
- Arvanitis,C & Felsher,DW,"*Conditionally MYC : insights from novel transgenic models*". Cancer Letters, **2005**;226, 95-99.
- Beckhaus,T, Corvey,C, Burre,J, Morciano,M, Zimmermann,H, Volkandt,W, & Karas,M,"*Different approaches for the characterisation of the synaptic vesicle proteome; Comparison of 1 D and 2D PAGE followed by mass spectrometry (MALDI-TOF; NANO-LC ESI MS/MS)*". Molecular & Cellular Proteomics, **2005**;4, S89-S89.
- Blackwood,EM & Eisenman,RN,"*Max - A Helix-Loop-Helix Zipper Protein That Forms A Sequence-Specific Dna-Binding Complex with Myc*". Science, **1991**;251, 1211-1217.
- Butler,SL, Dong,H, Cardona,D, Jia,M, Zheng,R, Zhu,H, Crawford,JM, & Liu,C,"*The antigen for Hep Par 1 antibody is the urea cycle enzyme carbamoyl phosphate synthetase 1*". Laboratory Investigation, **2008**;88, 78-88.
- Calvisi,DF, Conner,EA, Ladu,S, Lemmer,ER, Factor,VM, & Thorgeirsson,SS,"*Activation of the canonical Wnt/beta-catenin pathway confers growth advantages in c-Myc/E2F1 transgenic mouse model of liver cancer*". Journal of Hepatology, **2005a**;42, 842-849.
- Calvisi,DF & Thorgeirsson,SS,"*Molecular mechanisms of hepatocarcinogenesis in transgenic mouse models of liver cancer*". Toxicologic Pathology, **2005b**;33, 181-184.

- Castelli,A,"*How many patients with HCC have normal des-gamma-carboxy prothrombin and alpha-fetoprotein levels?*". Panminerva Medica, **2009**;51, 188-188.
- Chalasani,N, Vuppalanchi,R, Raikwar,NS, & Deeg,MA,"*Glycosylphosphatidylinositol-specific phospholipase D in nonalcoholic fatty liver disease: A preliminary study*". Journal of Clinical Endocrinology & Metabolism, **2006**;91, 2279-2285.
- Chan,KL, Guan,XY, & Oi-Lin,I,"*High-throughput tissue microarray analysis of c-myc activation in chronic liver diseases and hepatocellular carcinoma*". Human Pathology, **2004**;35, 1324-1331.
- Chatterji,B & Borlak,J,"*Serum proteomics of lung adenocarcinomas induced by targeted overexpression of c-raf in alveolar epithelium identifies candidate biomarkers*". Proteomics, **2007**;7, 3980-3991.
- Chatterji,B & Borlak,J,"*A 2-DE MALDI-TOF study to identify disease regulated serum proteins in lung cancer of c-myc transgenic mice*". Proteomics, **2009**;9, 1044-1056.
- Chen,R, Pan,S, Brentnall,TA, & Aebersold,R,"*Proteomic profiling of pancreatic cancer for biomarker discovery*". Molecular & Cellular Proteomics, **2005**;4, 523-533.
- Chen,X, Zhao,J, Guan,YH, Lu,S, Zuo,CT, Hua,FC, & Lin,XT,"*Prognostic value of 2-[F-18]fluoro-2-deoxy-D-glucose uptake as measured by PET scan in patients with non-small cell lung cancer*". Molecular Medicine Reports, **2008**;1, 889-893.
- Chen,YY, Lin,SY, Yeh,YY, Hsiao,HH, Wu,CY, Chen,ST, & Wang,AHJ,"*A modified protein precipitation procedure for efficient removal of albumin from serum*". Electrophoresis, **2005**;26, 2117-2127.
- Cho,WCS,"*Contribution of oncoproteomics to cancer biomarker discovery*". Molecular Cancer, **2007**;6
- Chung,EJ, Sung,YK, Farooq,M, Kim,Y, Im,S, Tak,WY, Hwang,YJ, Kim,YI, Han,HS, Kim,JC, & Kim,MK,"*Gene expression profile analysis in human hepatocellular carcinoma by cDNA microarray*". Molecules and Cells, **2002**;14, 382-387.
- Conner,EA, Lemmer,ER, Omori,M, Wirth,PJ, Factor,VM, & Thorgeirsson,SS,"*Dual functions of E2F-1 in a transgenic mouse model of liver carcinogenesis*". Oncogene, **2000**;19, 5054-5062.
- Cravatt,BF, Simon,GM, & Yates,JR,"*The biological impact of mass-spectrometry-based proteomics*". Nature, **2007**;450, 991-1000.
- Dalemans,W, Perraud,F, Le Meur,M, Gerlinger,P, Courtney,M, & Pavirani,A,"*Heterologous protein expression by transimmortalized differentiated liver cell lines derived from transgenic mice (hepatomas/alpha 1 antitrypsin/ONC mouse)*". Biologicals, **1990**;18, 191-198.

- Dang,CV,"*Rethinking the Warburg Effect with Myc Micromanaging Glutamine Metabolism*". Cancer Research, **2010**;70, 859-862.
- Dang,CV, Kim,JW, Gao,P, & Yustein,J,"*Hypoxia and metabolism - Opinion - The interplay between MYC and HIF in cancer*". Nature Reviews Cancer, **2008**;8, 51-56.
- Dang,CV & Lewis,BC,"*Role of oncogenic transcription factor c-Myc in cell cycle regulation, apoptosis and metabolism*". Journal of Biomedical Science, **1997**;4, 269-278.
- Dang,CV, Resar,LMS, Emison,E, Kim,S, Li,Q, Prescott,JE, Wonsey,D, & Zeller,K,"*Function of the c-Myc oncogenic transcription factor*". Experimental Cell Research, **1999a**;253, 63-77.
- Dang,CV & Semenza,GL,"*Oncogenic alterations of metabolism*". Trends in Biochemical Sciences, **1999b**;24, 68-72.
- Deeg,MA, Bierman,EL, & Cheung,MC,"*GPI-specific phospholipase D associates with an apoA-I- and apoA-IV-containing complex*". Journal of Lipid Research, **2001a**;42, 442-451.
- Deeg,MA, Bowen,RF, Williams,MD, Olson,LK, Kirk,EA, & LeBoeuf,RC,"*Increased expression of GPI-specific phospholipase D in mouse models of type 1 diabetes*". American Journal of Physiology-Endocrinology and Metabolism, **2001b**;281, E147-E154.
- Deeg,MA, Raikwar,NS, Johnson,C, & Williams,CD,"*Statin therapy reduces serum levels of glycosylphosphatidylinositol-specific phospholipase D*". Translational Research, **2007**;150, 153-157.
- Dellafavera,R, Gelmann,EP, Martinotti,S, Franchini,G, Papas,TS, Gallo,RC, & Wongstaal,F,"*Cloning and Characterization of Different Human Sequences Related to the Onc Gene (V-Myc) of Avian Myelocytomatosis Virus (Mc29)*". Proceedings of the National Academy of Sciences of the United States of America-Biological Sciences, **1982**;79, 6497-6501.
- Domon,B & Aebersold,R,"*Review - Mass spectrometry and protein analysis*". Science, **2006**;312, 212-217.
- Dotauer,A, Brenner,M, Gebhardt,U, & Vallbracht,A,"*IgA-coated particles of Hepatitis A virus are translocated antivectorially from the apical to the basolateral site of polarized epithelial cells via the polymeric immunoglobulin receptor*". Journal of General Virology, **2005**;86, 2747-2751.
- Du,XH & Low,MG,"*Down-regulation of glycosylphosphatidylinositol-specific phospholipase D induced by lipopolysaccharide and oxidative stress in the murine monocyte-macrophage cell line RAW 264.7*". Infection and Immunity, **2001**;69, 3214-3223.
- Duan,XB, Yarmush,D, Berthiaume,F, Jayaraman,A, & Yarmush,ML,"*Immunodepletion of albumin for two-dimensional gel detection*

- of new mouse acute-phase protein and other plasma proteins". Proteomics, 2005;5, 3991-4000.*
- Duan,XB, Yarmush,DM, Berthiaume,F, Jayaraman,A, & Yarmush,ML,"*A mouse serum two-dimensional gel map: Application to profiling burn injury and infection*". Electrophoresis, **2004;25, 3055-3065.**
- Dubois,N, Bennoun,M, Allemand,I, Molina,T, Grimber,G, Daudetmonsac,M, Abelanet,R, & Briand,P,"*Time-Course Development of Differentiated Hepatocarcinoma and Lung Metastasis in Transgenic Mice*". Journal of Hepatology, **1991;13, 227-239.**
- Durazo,FA, Blatt,LM, Corey,WG, Lin,JH, Han,S, Saab,S, Busuttil,RW, & Tong,MJ,"*Des-gamma-carboxyprothrombin, alpha-fetoprotein and AFP-L3 in patients with chronic hepatitis, cirrhosis and hepatocellular carcinoma*". Journal of Gastroenterology and Hepatology, **2008;23, 1541-1548.**
- Ederly,P, Gerard,B, Chretien,D, Rotig,A, Cerrone,R, Rabier,D, Rambaud,C, Fabre,M, Saudubray,JM, Munnich,A, & Rustin,P,"*Liver Cytochrome-C-Oxidase Deficiency in A Case of Neonatal-Onset Hepatic-Failure*". European Journal of Pediatrics, **1994;153, 190-194.**
- Facchini,LM & Penn,LZ,"*The molecular role of Myc in growth and transformation: recent discoveries lead to new insights*". Faseb Journal, **1998;12, 633-651.**
- Fang,YM, Vilella-Bach,M, Bachmann,R, Flanigan,A, & Chen,J,"*Phosphatidic acid-mediated mitogenic activation of mTOR signaling*". Science, **2001;294, 1942-1945.**
- Felsher,DW & Bishop,JM,"*Reversible tumorigenesis by MYC in hematopoietic lineages*". Molecular Cell, **1999;4, 199-207.**
- Foster,DA,"*Targeting phospholipase D-mediated survival signals in cancer*". Current Signal Transduction Therapy, **2006;1, 295-303.**
- Foster,DA & Xu,LZ,"*Phospholipase D in cell proliferation and cancer*". Molecular Cancer Research, **2003;1, 789-800.**
- Garaguso,I & Borlak,J,"*Matrix layer sample preparation: An improved MALDI-MS peptide analysis method for proteomic studies*". Proteomics, **2008;8, 2583-2595.**
- Gartel,AL & Shchors,K,"*Mechanisms of c-myc-mediated transcriptional repression of growth arrest genes*". Experimental Cell Research, **2003;283, 17-21.**
- Gazzana,G & Borlak,J,"*Mapping of the serum proteome of hepatocellular carcinoma induced by targeted overexpression of epidermal growth factor to liver cells of transgenic mice*". J Proteome Res, **2008;7, 928-937.**
- Ghose,A, Fleming,J, & Harrison,PR,"*Selenium and signal transduction: Roads to cell death and anti-tumour activity*". Biofactors, **2001;14, 127-133.**

- Giannelli,G & Antonaci,S,"*New frontiers in biomarkers for hepatocellular carcinoma*". Digestive and Liver Disease, **2006**;38, 854-859.
- Goodman,LA, Liu,BCS, Thiele,CJ, Schmidt,ML, Cohn,SL, Yamashiro,JM, Pai,DSM, Ikegaki,N, & Wada,RK,"*Modulation of N-myc expression alters the invasiveness of neuroblastoma*". Clinical & Experimental Metastasis, **1997**;15, 130-139.
- Gorg,A, Weiss,W, & Dunn,MJ,"*Current two-dimensional electrophoresis technology for proteomics*". Proteomics, **2004**;4, 3665-3685.
- Gray,J, Chattopadhyay,D, Beale,GS, Patman,GL, Miele,L, King,BP, Stewart,S, Hudson,M, Day,CP, Manas,DM, & Reeves,HL,"*A proteomic strategy to identify novel serum biomarkers for liver cirrhosis and hepatocellular cancer in individuals with fatty liver disease*". Bmc Cancer, **2009**;9
- Greenwood,E,"*The many faces of MYC*". Nature Reviews Cancer, **2002**;2, 485-485.
- Guo,QM, Malek,RL, Kim,S, Chiao,C, He,M, Ruffy,M, Sanka,K, Lee,NH, Dang,CV, & Liu,ET,"*Identification of c-Myc responsive genes using rat cDNA microarray*". Cancer Research, **2000**;60, 5922-5928.
- Haggerty,TJ, Zeller,KI, Osthus,RC, Wonsey,DR, & Dang,CV,"*A strategy for identifying transcription factor binding sites reveals two classes of genomic c-Myc target sites*". Proceedings of the National Academy of Sciences of the United States of America, **2003**;100, 5313-5318.
- Hao,LY, Giasson,BI, & Bonini,NM,"*DJ-1 is critical for mitochondrial function and rescues PINK1 loss of function*". Proceedings of the National Academy of Sciences of the United States of America, **2010**;107, 9747-9752.
- Harris,MN, Ozpolat,B, Abdi,F, Gu,S, Legler,A, Mawuenyega,KG, Tirado-Gomez,M, Lopez-Berestein,G, & Chen,X,"*Comparative proteomic analysis of all-trans-retinoic acid treatment reveals systematic posttranscriptional control mechanisms in acute promyelocytic leukemia*". Blood, **2004**;104, 1314-1323.
- Hatzivassiliou,G, Zhao,FP, Bauer,DE, Andreadis,C, Shaw,AN, Dhanak,D, Hingorani,SR, Tuveson,DA, & Thompson,CB,"*ATP citrate lyase inhibition can suppress tumor cell growth*". Cancer Cell, **2005**;8, 311-321.
- Huang,HL, Stasyk,T, Morandell,S, Dieplinger,H, Falkensammer,G, Griesmacher,A, Mogg,M, Schreiber,M, Feuerstein,I, Huck,CW, Stecher,G, Bonn,GK, & Huber,LA,"*Biomarker discovery in breast cancer serum using 2-D differential gel electrophoresis/MALDI-TOF/TOF and data validation by routine clinical assays*". Electrophoresis, **2006**;27, 1641-1650.
- Hui,L, Rodrik,V, Pielak,RM, Knirr,S, Zheng,Y, & Foster,DA,"*mTOR-dependent suppression of protein phosphatase 2A is critical for phospholipase D survival signals in human breast cancer cells*". Journal of Biological Chemistry, **2005**;280, 35829-35835.

- Hui,LJ, Zatloukal,K, Scheuch,H, Stepniak,E, & Wagner,EF,"*Proliferation of human HCC cells and chemically induced mouse liver cancers requires JNK1-dependent p21 downregulation*". Journal of Clinical Investigation, **2008**;118, 3943-3953.
- Irmak,MB, Ince,G, Ozturk,M, & Cetin-Atalay,R,"*Acquired tolerance of hepatocellular carcinoma cells to selenium deficiency: A selective survival mechanism?*". Cancer Research, **2003**;63, 6707-6715.
- Jemal,A, Siegel,R, Ward,E, Hao,Y, Xu,J, Murray,T, & Thun,MJ,"*Cancer statistics, 2008*". CA Cancer J Clin, **2008**;58, 71-96.
- Jenssen,TK, Laegreid,A, Komorowski,J, & Hovig,E,"*A literature network of human genes for high-throughput analysis of gene expression*". Nature Genetics, **2001**;28, 21-+.
- Jhappan,C, Stahle,C, Harkins,RN, Fausto,N, Smith,GH, & Merlino,GT,"*Tgf-Alpha Overexpression in Transgenic Mice Induces Liver Neoplasia and Abnormal-Development of the Mammary-Gland and Pancreas*". Cell, **1990**;61, 1137-1146.
- Jian-Hua,T, Wang-Jiao,H, He,H, Chao-Chao,T, Qiong,D, Kai-Jia,W, Xian-Yu,Y, & Xu-Jin,Z,"*Important roles of glycosylphosphatidylinositol (GPI)-specific phospholipase D and some GPI-anchored proteins in the pathogenesis of hepatocellular carcinoma*". Clinical Biochemistry, **2009**;42, 400-407.
- Jiang,JT, Nilsson-Ehle,P, & Xu,N,"*Influence of liver cancer on lipid and lipoprotein metabolism*". Lipids in Health and Disease, **2006**;5
- Joseph,P, Lei,YX, Whong,WZ, & Ong,TM,"*Oncogenic potential of mouse translation elongation factor-15, a novel cadmium-responsive proto-oncogene*". Journal of Biological Chemistry, **2002**;277, 6131-6136.
- Joseph,T, Bryant,A, Frankel,P, Wooden,R, Kerkhoff,E, Rapp,UR, & Foster,DA,"*Phospholipase D overcomes cell cycle arrest induced by high-intensity Raf signaling*". Oncogene, **2002**;21, 3651-3658.
- Juan,HF, Chen,JH, Hsu,WT, Huang,SC, Chen,ST, Lin,JYC, Chang,YW, Chiang,CY, Wen,LL, Chan,DC, Liu,YC, & Chen,YJ,"*Identification of tumor-associated plasma biomarkers using proteomic techniques: From mouse to human*". Proteomics, **2004**;4, 2766-2775.
- Kerkhoff,E, Houben,R, Loffler,S, Troppmair,J, & Rapp,UR,"*Regulation of c-myc expression by Ras/Raf signalling*". Oncogene, **1998**;16, 211-216.
- Kleine-Kohlbrecher,D, Adhikary,S, & Eilers,M,"*Mechanisms of transcriptional repression by Myc*". Myc/Max/Mad Transcription Factor Network, **2006**;302, 51-62.
- Krutchinsky,AN & Chait,BT,"*On the nature of the chemical noise in MALDI mass spectra*". Journal of the American Society for Mass Spectrometry, **2002**;13, 129-134.

- Kuick,R, Misek,DE, Monsma,DJD, Webb,CP, Wang,H, Peterson,KJ, Pisano,M, Omenn,GS, & Hanash,SM,"*Discovery of cancer biomarkers through the use of mouse models*". Cancer Letters, **2007**;249, 40-48.
- Kuramitsu,Y, Harada,T, Takashima,M, Yokoyama,Y, Hidaka,I, Iizuka,N, Toda,T, Fujimoto,M, Zhang,XL, Sakaida,I, Okita,K, Oka,M, & Nakamura,K,"*Increased expression and phosphorylation of liver glutamine synthetase in well-differentiated hepatocellular carcinoma tissues from patients infected with hepatitis C virus*". Electrophoresis, **2006**;27, 1651-1658.
- Kuystermans,D, Dunn,MJ, & Al Rubeai,M,"*A proteomic study of cMyc improvement of CHO culture*". Bmc Biotechnology, **2010**;10
- Lai,KKY, Kolippakkam,D, & Beretta,L,"*Comprehensive and quantitative proteome profiling of the mouse liver and plasma*". Hepatology, **2008**;47, 1043-1051.
- Land,H, Chen,AC, Morgenstern,JP, Parada,LF, & Weinberg,RA,"*Behavior of Myc and Ras Oncogenes in Transformation of Rat Embryo Fibroblasts*". Molecular and Cellular Biology, **1986**;6, 1917-1925.
- Larson,SM,"*Positron emission tomography-based molecular imaging in human cancer: Exploring the link between hypoxia and accelerated glucose metabolism*". Clinical Cancer Research, **2004**;10, 2203-2204.
- Larsson,LG & Henriksson,MA,"*The Yin and Yang functions of the Myc oncoprotein in cancer development and as targets for therapy*". Experimental Cell Research, **2010**;316, 1429-1437.
- Laugesen,S & Roepstorff,P,"*Combination of two matrices results in improved performance of MALDI MS for peptide mass mapping and protein analysis*". Journal of the American Society for Mass Spectrometry, **2003**;14, 992-1002.
- Lee,GH, Merlino,G, & Fausto,N,"*Development of Liver-Tumors in Transforming Growth Factor-Alpha Transgenic Mice*". Cancer Research, **1992**;52, 5162-5170.
- Li,C, Hong,Y, Tan,YX, Zhou,H, Ai,JH, Li,SJ, Zhang,L, Xia,QC, Wu,JR, Wang,HY, & Zeng,R,"*Accurate qualitative and quantitative proteomic analysis of clinical hepatocellular carcinoma using laser capture microdissection coupled with isotope-coded affinity tag and two-dimensional liquid chromatography mass spectrometry*". Molecular & Cellular Proteomics, **2004**;3, 399-409.
- Li,LH, Nerlov,C, Prendergast,G, Macgregor,D, & Ziff,EB,"*C-Myc Represses Transcription In-Vivo by A Novel Mechanism Dependent on the Initiator Element and Myc Box-I*". Embo Journal, **1994**;13, 4070-4079.
- Lim,SO, Park,SJ, Kim,W, Park,SG, Kim,HJ, Kim,YI, Sohn,TS, Noh,JH, & Jung,G,"*Proteome analysis of hepatocellular carcinoma*". Biochemical and Biophysical Research Communications, **2002**;291, 1031-1037.
- Liscovitch,M, Czarny,M, Fiucci,G, & Tang,XQ,"*Phospholipase D: molecular and cell biology of a novel gene family*". Biochemical Journal, **2000**;345, 401-415.

- Liu,Q, Basu,S, Qiu,Y, Tang,F, & Dong,F,"*A role of Miz-1 in Gfi-1-mediated transcriptional repression of CDKN1A*". *Oncogene*, **2010**;29, 2843-2852.
- Low,MG & Huang,KS,"*Phosphatidic-Acid, Lysophosphatidic Acid, and Lipid-A Are Inhibitors of Glycosylphosphatidylinositol-Specific Phospholipase-D - Specific-Inhibition of A Phospholipase by Product Analogs*". *Journal of Biological Chemistry*, **1993**;268, 8480-8490.
- Luo,GH, Marginean,I, & Vertes,A,"*Internal energy of ions generated by matrix-assisted laser desorption/ionization*". *Analytical Chemistry*, **2002**;74, 6185-6190.
- McMahon,SB, Wood,MA, & Cole,MD,"*The essential cofactor TRRAP recruits the histone acetyltransferase hGCN5 to c-Myc*". *Molecular and Cellular Biology*, **2000**;20, 556-562.
- Menssen,A & Hermeking,H,"*Characterization of the c-MYC-regulated transcriptome by SAGE: Identification and analysis of c-MYC target genes*". *Proceedings of the National Academy of Sciences of the United States of America*, **2002**;99, 6274-6279.
- Miyoshi,Y, Nakayama,S, Torikoshi,Y, Tanaka,S, Ishihara,H, Taguchi,T, Tamaki,Y, & Noguchi,S,"*High expression of ubiquitin carboxy-terminal hydrolase-L1 and -L3 mRNA predicts early recurrence in patients with invasive breast cancer*". *Cancer Science*, **2006**;97, 523-529.
- Mostafavi,S, Ray,D, Warde-Farley,D, Grouios,C, & Morris,Q,"*GeneMANIA: a real-time multiple association network integration algorithm for predicting gene function*". *Genome Biology*, **2008**;9
- Nalepa,G & Harper,JW,"*Therapeutic anti-cancer targets upstream of the proteasome*". *Cancer Treatment Reviews*, **2003**;29, 49-57.
- Oike,Y, Ito,Y, Maekawa,H, Morisada,T, Kubota,Y, Akao,M, Urano,T, Yasunaga,K, & Suda,T,"*Angiopoietin-related growth factor (AGF) promotes angiogenesis*". *Blood*, **2004**;103, 3760-3765.
- Ooi,K, Shiraki,K, Sakurai,Y, Morishita,Y, & Nobori,T,"*Clinical significance of abnormal lipoprotein patterns in liver diseases*". *International Journal of Molecular Medicine*, **2005**;15, 655-660.
- Oskarsson,T & Trumpp,A,"*The Myc trilogy: lord of RNA polymerases*". *Nature Cell Biology*, **2005**;7, 215-217.
- Padliya,ND & Wood,TD,"*A strategy to improve peptide mass fingerprinting matches through the optimization of matrix-assisted laser desorption/ionization matrix selection and formulation*". *Proteomics*, **2004**;4, 466-473.
- Palmiter,RD, Brinster,RL, Hammer,RE, Trumbauer,ME, Rosenfeld,MG, Birnberg,NC, & Evans,RM,"*Dramatic Growth of Mice That Develop from Eggs Micro-Injected with Metallothioneine-Growth Hormone Fusion Genes*". *Nature*, **1982**;300, 611-615.

- Pan,S, Aebersold,R, Chen,R, Rush,J, Goodlett,DR, McIntosh,MW, Zhang,J, & Brentnall,TA,"*Mass Spectrometry Based Targeted Protein Quantification: Methods and Applications*". Journal of Proteome Research, **2009**;8, 787-797.
- Pascale,RM, Simile,MM, Calvisi,DF, Frau,M, Muroi,MR, Seddaiu,MA, Daino,L, Muntoni,MD, De Miglio,MR, Thorgeirsson,SS, & Feo,F,"*Role of HSP90, CDC37, and CRM1 as modulators of P16(INK4A) activity in rat liver carcinogenesis and human liver cancer*". Hepatology, **2005**;42, 1310-1319.
- Patel,JH & McMahon,SB,"*Targeting of Miz-1 is essential for Myc-mediated apoptosis*". Journal of Biological Chemistry, **2006**;281, 3283-3289.
- Pelengaris,S & Khan,M,"*The many faces of c-MYC*". Archives of Biochemistry and Biophysics, **2003**;416, 129-136.
- Penque,D,"*Two-dimensional gel electrophoresis and mass spectrometry for biomarker discovery*". Proteomics Clinical Applications, **2009**;3, 155-172.
- Pietenpol,JA, Holt,JT, Stein,RW, & Moses,HL,"*Transforming Growth Factor-Beta-1 Suppression of C-Myc Gene-Transcription - Role in Inhibition of Keratinocyte Proliferation*". Proceedings of the National Academy of Sciences of the United States of America, **1990**;87, 3758-3762.
- Plummer,G, Perreault,KR, Holmes,CFB, & De Chaves,EIP,"*Activation of serine/threonine protein phosphatase-1 is required for ceramide-induced survival of sympathetic neurons*". Biochemical Journal, **2005**;385, 685-693.
- Prendergast,GC & Ziff,EB,"*Methylation-Sensitive Sequence-Specific Dna-Binding by the C-Myc Basic Region*". Science, **1991**;251, 186-189.
- Ramana,CV, Grammatikakis,N, Chernov,M, Nguyen,H, Goh,KC, Williams,BRG, & Stark,GR,"*Regulation of c-myc expression by IFN-gamma through Stat1-dependent and -independent pathways*". Embo Journal, **2000**;19, 263-272.
- Reymann,S & Borlak,J,"*Transcription profiling of lung adenocarcinomas of c-myc-transgenic mice: Identification of the c-myc regulatory gene network*". BMC Systems Biology, **2008**;2
- Rhoads,JM, Argenzio,RA, Chen,WN, Rippe,RA, Westwick,JK, Cox,AD, Berschneider,HM, & Brenner,DA,"*L-glutamine stimulates intestinal cell proliferation and activates mitogen-activated protein kinases*". American Journal of Physiology-Gastrointestinal and Liver Physiology, **1997**;35, G943-G953.
- Rhode,H, Lopatta,E, Schulze,M, Pascual,C, Schulze,HP, Schubert,K, Schubert,H, Reinhart,K, & Horn,A,"*Glycosylphosphatidylinositol-specific phospholipase D in blood serum: Is the liver the only source of the enzyme?*". Clinica Chimica Acta, **1999**;281, 127-145.

- Rhode,H, Schulze,M, Cumme,GA, Gohlert,A, Blume,E, Bublitz,R, Schilling,K, & Horn,A,"*Glycosylphosphatidylinositol-specific phospholipase D of human serum-activity modulation by naturally occurring amphiphiles*". Biological Chemistry, **2000**;381, 471-485.
- Ritorto,MS & Borlak,J,"*A simple and reliable protocol for mouse serum proteome profiling studies by use of two-dimensional electrophoresis and MALDI TOF/TOF mass spectrometry*". Proteome Sci, **2008**;6, 25-
- Robinson,L, Grau,P, & Crandall,BF,"*Pregnancy Outcomes After Increasing Maternal Serum Alpha-Fetoprotein Levels*". Obstetrics and Gynecology, **1989**;74, 17-20.
- Rocchiccioli,S, Citti,L, Boccardi,C, Ucciferri,N, Tedeschi,L, Lande,C, Trivella,MG, & Cecchettini,A,"*A gel-free approach in vascular smooth muscle cell proteome: perspectives for a better insight into activation*". Proteome Science, **2010**;8
- Rodrik,V, Gomes,E, Hui,L, Rockwell,P, & Foster,DA,"*Myc stabilization in response to estrogen and phospholipase D in MCF-7 breast cancer cells*". Febs Letters, **2006**;580, 5647-5652.
- Rodrik,V, Zheng,Y, Harrow,F, Chen,YH, & Foster,DA,"*Survival signals generated by estrogen and phospholipase D in MCF-7 breast cancer cells are dependent on Myc*". Molecular and Cellular Biology, **2005**;25, 7917-7925.
- Roigas,J, Deger,S, Schroeder,J, Wille,A, Turk,I, Brux,B, Jung,K, Schnorr,D, & Loening,SA,"*Tumor type M2 pyruvate kinase expression in metastatic renal cell carcinoma*". Urological Research, **2003**;31, 358-362.
- Santi,V, Trevisani,F, Gramenzi,A, Casadio,R, Di Nolfo,MA, Del Poggio,P, Benvegna,L, Rapaccini,G, Farinati,F, Zoli,M, Borzio,E, Giannini,EG, Caturelli,E, & Bernardi,M,"*Surveillance for early diagnosis of hepatocellular carcinoma: Is it effective in intermediate/advanced cirrhosis?*". Journal of Hepatology, **2007**;46, S110-S110.
- Scheers,I, Bachy,V, Stephenne,X, & Sokal,EM,"*Risk of hepatocellular carcinoma in liver mitochondrial respiratory chain disorders*". Journal of Pediatrics, **2005**;146, 414-417.
- Schlaeger,C, Longerich,T, Schiller,C, Bewerunge,P, Mehrabi,A, Toedt,G, Kleeff,J, Ehemann,V, Eils,R, Lichter,P, Schirtnacher,P, & Radwimmer,B,"*Etiology-dependent molecular mechanisms in human hepatocarcinogenesis*". Hepatology, **2008**;47, 511-520.
- Schulein,C & Eilers,M,"*An unsteady scaffold for Myc*". Embo Journal, **2009**;28, 453-454.
- Sears,R, Leone,G, DeGregori,J, & Nevins,JR,"*Ras enhances Myc protein stability*". Molecular Cell, **1999**;3, 169-179.
- Setsuie,R & Wada,K,"*The functions of UCH-L1 and its relation to neurodegenerative diseases*". Neurochemistry International, **2007**;51, 105-111.

- Sherman,M,"*Alphafetoprotein: an obituary*". Journal of Hepatology, **2001**;34, 603-605.
- Shi,M, Zheng,Y, Garcia,A, Xu,LZ, & Foster,DA,"*Phospholipase D provides a survival signal in human cancer cells with activated H-Ras or K-Ras*". Cancer Letters, **2007**;258, 268-275.
- Shuldiner,AR,"*Transgenic animals*". New England Journal of Medicine, **1996**;334, 653-655.
- Singh,M & Kumar,V,"*Transgenic mouse models of hepatitis B virus-associated hepatocellular carcinoma*". Reviews in Medical Virology, **2003**;13, 243-253.
- Smirnov,IP, Zhu,X, Taylor,T, Huang,Y, Ross,P, Papayanopoulos,IA, Martin,SA, & Pappin,DJ,"*Suppression of alpha-cyano-4-hydroxycinnamic acid matrix clusters and reduction of chemical noise in MALDI-TOF mass spectrometry*". Analytical Chemistry, **2004**;76, 2958-2965.
- Song,YD, Wu,JH, Oyesanya,RA, Lee,Z, Mukherjee,A, & Fang,XJ,"*Sp-1 and c-Myc Mediate Lysophosphatidic Acid-Induced Expression of Vascular Endothelial Growth Factor in Ovarian Cancer Cells via a Hypoxia-Inducible Factor-1-Independent Mechanism*". Clinical Cancer Research, **2009**;15, 492-501.
- Soucek,L, Jucker,R, Panacchia,L, Ricordy,R, Tato,F, & Nasi,S,"*Omomyc, a potential Myc dominant negative, enhances Myc-induced apoptosis*". Cancer Research, **2002**;62, 3507-3510.
- Stephensen,CB & Gildengorin,G,"*Serum retinol, the acute phase response, and the apparent misclassification of vitamin A status in the third National Health and Nutrition Examination Survey*". American Journal of Clinical Nutrition, **2000**;72, 1170-1178.
- Sundsten,T, Eberhardson,M, Goransson,M, & Bergsten,P,"*The use of proteomics in identifying differentially expressed serum proteins in humans with type 2 diabetes*". Proteome Science, **2006**;4
- Supino S., Scovassi A.I. "*c-myc: a double-headed Janus that regulates cell survival and death*". Gene Ther. Mol. Biol. **2004**: 385-394.
- Terradillos,O, Billet,O, Renard,CA, Levy,R, Molina,T, Briand,P, & Buendia,MA,"*The hepatitis B virus X gene potentiates c-myc-induced liver oncogenesis in transgenic mice*". Oncogene, **1997**;14, 395-404.
- Thorgeirsson,SS & SantoniRugiu,E,"*Transgenic mouse models in carcinogenesis: Interaction of c-myc with transforming growth factor alpha and hepatocyte growth factor in hepatocarcinogenesis*". British Journal of Clinical Pharmacology, **1996**;42, 43-52.
- Tsuboi,S,"*Elevation of glutathione level in rat hepatocytes by hepatocyte growth factor via induction of gamma-glutamylcysteine synthetase*". Journal of Biochemistry, **1999**;126, 815-820.

- Um,SJ, Lee,SY, Kim,EJ, Han,HS, Koh,YM, Hong,KJ, Sin,HS, & Park,JS,"*Antiproliferative mechanism of retinoid derivatives in ovarian cancer cells*". Cancer Letters, **2001**;174, 127-134.
- Vafa,O, Wade,M, Kern,S, Beeche,M, Pandita,TK, Hampton,GM, & Wahl,GM,"*c-Myc can induce DNA damage, increase reactive oxygen species, and mitigate p53 function: A mechanism for oncogene-induced genetic instability*". Molecular Cell, **2002**;9, 1031-1044.
- Valledor,L & Jorin,J,"*Back to the basics: Maximizing the information obtained by quantitative two dimensional gel electrophoresis analyses by an appropriate experimental design and statistical analyses*". J Proteomics, **2010**;1.
- van de Wetering,M, Sancho,E, Verweij,C, de Lau,W, Oving,I, Hurlstone,A, van der Horn,K, Batlle,E, Coudreuse,D, Haramis,AP, Tion-Pon-Fong,M, Moerer,P, van den Born,M, Soete,G, Pals,S, Eilers,M, Medema,R, & Clevers,H,"*The beta-catenin/TCF-4 complex imposes a crypt progenitor phenotype on colorectal cancer cells*". Cell, **2002**;111, 241-250.
- van Riggelen,J, Yetil,A, & Felsher,DW,"*MYC as a regulator of ribosome biogenesis and protein synthesis*". Nature Reviews Cancer, **2010**;10, 301-309.
- Vennstrom,B, Sheiness,D, Zabielski,J, & Bishop,JM,"*Isolation and Characterization of C-Myc, A Cellular Homolog of the Oncogene (V-Myc) of Avian Myelocytomatosis Virus Strain-29*". Journal of Virology, **1982**;42, 773-779.
- Viola,M, Vigetti,D, Genasetti,A, Rizzi,M, Karousou,E, Moretto,P, Clerici,M, Bartolini,B, Pallotti,F, De Luca,G, & Passi,A,"*Molecular control of the hyaluronan biosynthesis*". Connective Tissue Research, **2008**;49, 111-114.
- Wait,R, Chiesa,G, Parolini,C, Miller,I, Begum,S, Brambilla,D, Galluccio,L, Ballerio,R, Eberini,I, & Gianazza,E,"*Reference maps of mouse serum acute-phase proteins: Changes with LPS-induced inflammation and apolipoprotein A-I and A-II transgenes*". Proteomics, **2005**;5, 4245-4253.
- Warburg, O, "*On the origin of cancer cells*" Science **1956**; 123:309-14.
- Watson,JD, Oster,SK, Shago,M, Khosravi,F, & Penn,LZ,"*Identifying genes regulated in a Myc-dependent manner*". Journal of Biological Chemistry, **2002**;277, 36921-36930.
- Wise,DR, DeBerardinis,RJ, Mancuso,A, Sayed,N, Zhang,XY, Pfeiffer,HK, Nissim,I, Daikhin,E, Yudkoff,M, McMahon,SB, & Thompson,CB,"*Myc regulates a transcriptional program that stimulates mitochondrial glutaminolysis and leads to glutamine addiction*". Proceedings of the National Academy of Sciences of the United States of America, **2008**;105, 18782-18787.
- Wonsey,DR, Zeller,KI, & Dang,CV,"*The c-Myc target gene PRDX3 is required mitochondrial homeostasis and neoplastic transformation*". Proceedings of the National Academy of Sciences of the United States of America, **2002**;99, 6649-6654.

- Wu, HY, Jia, WP, Bao, YQ, Lu, JX, Zhu, JH, Wang, R, Chen, YQ, & Xiang, K, "Serum retinol binding protein 4 and nonalcoholic fatty liver disease in patients with type 2 diabetes mellitus". *Diabetes Research and Clinical Practice*, **2008**;79, 185-190.
- Wulfkuehle, JD, Liotta, LA, & Petricoin, EF, "Proteomic applications for the early detection of cancer". *Nature Reviews Cancer*, **2003**;3, 267-275.
- Xuan, SY, Xin, YN, Chen, H, Shi, GJ, Guan, HS, & Li, Y, "Significance of hepatitis B virus surface antigen, hepatitis C virus expression in hepatocellular carcinoma and pericarcinomatous tissues". *World Journal of Gastroenterology*, **2007**;13, 1870-1874.
- Yates, JR, "Mass spectral analysis in proteomics". *Annual Review of Biophysics and Biomolecular Structure*, **2004**;33, 297-316.
- Yeung, K, Janosch, P, McFerran, B, Rose, DW, Mischak, H, Sedivy, JM, & Kolch, W, "Mechanism of suppression of the Raf/MEK/extracellular signal-regulated kinase pathway by the Raf kinase inhibitor protein". *Molecular and Cellular Biology*, **2000**;20, 3079-3085.
- Yokoyama, Y, Kuramitsu, Y, Takashima, M, Iizuka, N, Terai, S, Oka, M, Nakamura, K, Okita, K, & Sakaida, I, "Protein level of apolipoprotein E increased in human hepatocellular carcinoma". *International Journal of Oncology*, **2006**;28, 625-631.
- Zhang, MQ, "Prediction, annotation, and analysis of human promoters". *Cold Spring Harbor Symposia on Quantitative Biology*, **2003**;68, 217-225.
- Zheng, Y, Rodrik, V, Toschi, A, Shi, M, Hui, L, Shen, YJ, & Foster, DA, "Phospholipase D couples survival and migration signals in stress response of human cancer cells". *Journal of Biological Chemistry*, **2006**;281, 15862-15868.
- Zhou, YJ, Jiang, L, & Rui, LY, "Identification of MUP1 as a Regulator for Glucose and Lipid Metabolism in Mice". *Journal of Biological Chemistry*, **2009**;284, 11152-11159.
- Zhu, X & Papayannopoulos, IA, "Improvement in the detection of low concentration protein digests on a MALDI TOF/TOF workstation by reducing alpha-cyano-4-hydroxycinnamic acid adduct ions". *J Biomol. Tech.*, **2003**;14, 298-307.
- Zinkin, NT, Grall, F, Bhaskar, K, Otu, HH, Spentzos, D, Kalmowitz, B, Wells, M, Guerrero, M, Asara, JM, Libermann, TA, & Afdhal, NH, "Serum proteomics and biomarkers in hepatocellular carcinoma and chronic liver disease". *Clin Cancer Res*, **2008**;14, 470-477.

Webgraphy

➤ **Big-PI predictor**

http://mendel.imp.ac.at/gpi/gpi_server.html

Application for the prediction of protein GPI lipid anchor cleavage sites (update 2005)

➤ **BioPortfolio**

<http://www.bioportfolio.com/>

The biotechnology, pharmaceutical, healthcare, medical device, diagnostic and life science portal.

➤ **c-Myc Gene Database**

<http://www.mycancer.org/>

It provides a hub for the integration of information on Myc target genes, the role of Myc in human cancers, and proteins that interact with the Myc transcription factors. Links are provided that connect to PUBMED citations, Unigene database, and in specific cases to original data.

➤ **ChemSpider**

<http://www.chemspider.com/>

It is a free-to-access collection of compound data from across the web, provided by the Royal Society of Chemistry (RSC). It aggregates chemical structures and their associated information into a single searchable repository and makes it available to everybody. ChemSpider builds on the collected sources by adding additional properties, related information and links back to original data sources. ChemSpider offers text and structure searching to find compounds of interest and provides unique services to improve this data by curation and annotation and to integrate it with users' applications.

➤ **CSHL Promoter Database**

<http://rulai.cshl.edu/cgi-bin/CSHLmpd2/mmpd.pl>

MmPD (mouse database) supports to search promoter location based on keyword search. keywords include the NCBI mRNA Accession number, NCBI Unigene cluster ID, NCBI LocusLink ID, and others (some gene name, like Cdc2a).

➤ **Expasy**

<http://expasy.org/>

The ExPASy (Expert Protein Analysis System) proteomics server of the Swiss Institute of Bioinformatics (SIB) is dedicated to the analysis of protein sequences and structures as well as 2-D PAGE.

➤ **FragAnchor**

<http://navet.ics.hawaii.edu/%7efraganchor/cgi-bin/l8db.pl>

It is based on the tandem use of a Neural Network predictor and a Hidden Markov Model predictor. The Neural Network is used to select the potential GPI-anchored sequences and the Hidden Markov Model classifies the selected sequences according to four different levels of precision (highly probable, probable, weakly probable, potential false positive). The Hidden Markov Model proposes also up to three possible locations for the anchor/cleavage site.

➤ **GeneMANIA**

<http://genemania.org/>

It helps to predict the function of query gene sets.

GeneMANIA finds other genes that are related to a set of input genes, using a very large set of functional association data. Association data include protein and genetic interactions, pathways, co-expression, co-localization and protein domain similarity. You can use GeneMANIA to find new members of a pathway or complex, find additional genes you may have missed in your screen or find new genes with a specific function, such as protein kinases. Your question is defined by the set of genes you input./

➤ **Globocan**

<http://globocan.iarc.fr/>

Provides access to the most recent estimates (for 2008) of the incidence of, and mortality from 27 major cancers worldwide

➤ **Go-Proteomics**

<http://www.wileyvch.de/goproteomics/index.php?page=meetingsdiary>

The premier source of proteome information

➤ **GPI-SOM (KohGPI)**

<http://gpi.unibe.ch/>

GPI-SOM: Identification of GPI-anchor signals by a Kohonen Self Organizing Map

➤ **IPI**

<http://www.ebi.ac.uk/IPI/IPIhelp.html>

IPI (International Protein Index) provides a top level guide to the main databases that describe the proteomes of higher eukaryotic organisms. Single species databases from species whose genome has been sequenced. Content includes protein entries in the UniProtKB database, plus predicted protein sequences from Ensembl and RefSeq.

➤ **Mascot**

<http://www.matrixscience.com/>

It is a powerful search engine that uses mass spectrometry data to identify proteins from primary sequence databases. Mascot incorporates code from Mowse, developed by Darryl Pappin and David Perkins when working at the former Imperial Cancer Research Fund, and licensed from its technology transfer subsidiary, Cancer Research Technology. Swiss-Prot is on this web site for searching with Mascot.

➤ **MF Calc**

<http://home.pacbell.net/jdeline/>

MF Calc ("Molecular Fragment Calculator") takes a user defined mass and calculate all of the possible elemental combinations possible with that mass. The program is very flexible in that the user can control the degree of the precision of the mass, as well as which elements (and the amounts) that should be included in the search. It calculates an exact formula from a high-resolution mass spec value.

➤ **MoIE**

<http://library.med.utah.edu/masspec/mole.htm>

It calculates molecular masses and isotope ratios from elemental compositions.

➤ **MSDB**

<http://proteomics.leeds.ac.uk/bioinf/msdb.html>

The **Mass Spectrometry protein sequence DataBase** is compiled by the Proteomics Group at Imperial College London. MSDB is a composite, non-identical protein sequence database built from a number of primary source databases. Sequences from the higher priority databases are preferentially retained. The present source databases (in order of priority) are: PIR, Trembl, GenBank, Swiss-Prot, and NRL3D. One of the main advantages of MSDB is the accompanying full-text reference file.

➤ **NCBI**

<http://www.ncbi.nlm.nih.gov/>

The **National Center for Biotechnology Information** has been developed in 1988 as a division of the National Library of Medicine (NLM) at the National Institutes of Health (NIH) to develop new information technologies to aid in the understanding of fundamental molecular and genetic processes that control health and disease. More specifically, the NCBI has been charged with creating automated systems for storing and analyzing knowledge about molecular biology, biochemistry, and genetics; facilitating the use of such databases and software by the research and medical community; coordinating efforts to gather biotechnology information both nationally and internationally; and performing research into advanced methods of computer-based information processing for analyzing the structure and function of biologically important molecules.

NCBI nr: a non-redundant database compiled by NCBI by combining most of the public domain databases (EST's not included).

➤ **oncoDB**

<http://oncodb.hcc.ibms.sinica.edu.tw/index.htm>

It is based on physical maps of rodent and human genomes containing quantitative trait loci of rodent HCC models and various human HCC somatic aberrations including chromosomal data from loss of heterozygosity and comparative genome hybridization analyses, altered expression of genes from microarray and proteomic studies, and finally experimental data of published HCC genes.

➤ **PredGPI**

<http://gpcr2.biocomp.unibo.it/predgpi/>

It is a prediction system for GPI-anchored proteins. It is based on a support vector machine (SVM) for the discrimination of the anchoring signal, and on a Hidden Markov Model (HMM) for the prediction of the most probable omega-site

➤ **ProteinLounge™Beta**

<http://www.proteinlounge.com/>

It is a Bioinformatics Portal, Now Available to NIH Staff.

Protein Lounge organizes gene/protein data into a single gateway, improving access and supporting greater understanding of systems biology.

➤ **ProteinProspector™**

<http://prospector.ucsf.edu/prospector/mshome.htm>

Proteomics tools for mining sequence databases in conjunction with Mass Spectrometry experiments.

➤ **PubGENEBeta**

<http://www.pubgene.org/>

PubGene is designed to present information on genes, proteins and related keywords in an organized and intuitive form. PubGene subscribers use a graphic interface to access databases that catalogue the occurrence of symbols and phrases identifying genes in the scientific literature. Databases are updated on a biweekly basis through searches of MEDLINE records. Searches are performed using a list of synonyms for each gene that include the primary gene ID (as listed in Entrez Gene) and other symbols and phrases used to identify the gene and its protein product. Furthermore, the graphic interface can present lists of articles, allowing the researcher to find all records mentioning the gene. PubGene uses co-citation to create networks of gene identifiers, allowing the possibility for the discovery of relationships between two genes via an intermediary gene. In addition to lists of articles, PubGene can search for keywords using gene identifiers, or use keywords to find genes (MeSH, GO and chemical identifiers).

➤ **PubMed**

<http://www.ncbi.nlm.nih.gov/sites/entrez>

PubMed, a service of the National Library of Medicine, includes over 15 million citations for biomedical articles back to the 1950's. These citations are from MEDLINE and additional life science journals. PubMed includes links to many sites providing full text articles and other related resources.

➤ **SwissProt**

<http://www.expasy.ch/sprot/sprot-top.html>

A curated protein sequence database which strives to provide a high level of annotations (such as the description of the function of a protein, its domains structure, post-translational modifications, variants, etc), a minimal level of redundancy and high level of integration with other databases.

➤ **UniProtKB**

<http://expasy.org/sprot/>

Merger of the information contained in Swiss-Prot, TrEMBL and PIR to produce a comprehensive database. All entries are highly annotated, some manually (Swiss-Prot and PIR) whilst other in an automated fashion using sequence similarity to previously annotated proteins (TrEMBL).

Tables

Table 1

No.	SwissProt entry	SwissProt accession	Mw (KDa)	PI	Mascot score	sequence coverage (%)	msms (m/z)	matrix	Our Map 1	Ref Map 2	Ref Map 3	Ref Map 4	Ref Map 5	Ref Map 6
1	A1AG1 MOUSE	Q60590	24	5.6	124	32	1703.91	CHCA DHB	10	not present	4	12	5 (up regulated)	present
2	AMB P MOUSE	Q07456	40	6	38	4	1669.85	CHCA	1	3*	<i>not present</i>	<i>not present</i>	<i>not present</i>	<i>not present</i>
3	APOM MOUSE	Q9Z1R3	21.6	6	105	36	938.42	CHCA DHB	9	not present	<i>not present</i>	<i>not present</i>	<i>not present</i>	present
4	MUP1 MOUSE	P11588	20.9	5	115	55		DHB	12	0	10	not present	<i>not present</i>	<i>not present</i>
	MUP2 MOUSE	P11589	20.9	5	146	68		DHB	14	0	11	19	not present	<i>not present</i>
	MUP6 MOUSE	P02762	20.9	5	133	74		DHB	13	0	10	not present	<i>not present</i>	<i>not present</i>
	MUP8 MOUSE	P04938	17.7	5	137			DHB	<i>not present</i>	0	<i>not present</i>	not present	<i>not present</i>	<i>not present</i>
5	A1AT1 MOUSE	P07758	46.1	5.4	145	41	981.56 1137.66 1232.70 2003.04 2327.09 2405.17 3498.80	CHCA DHB	15	10* 2'	13	12	20 (up regulated)	not present
	A1AT2 MOUSE	P22599	46.1	5.3	104	36	2405.17 2003.04 2327.09 3498.80	CHCA DHB	12	9'	not present	7	3 (up regulated)	present
	A1AT3 MOUSE	Q00896	46	5.3	146	44	981.56 1137.66 2003.04 2327.09 2405.17 3498.80	CHCA DHB	15	not present	16	15	not present	<i>not present</i>

Table1...continued

No.	SwissProt entry	SwissProt accession	Mw (KDa)	PI	Mascot score	sequence coverage (%)	<i>msms</i> (m/z)	<i>matrix</i>	Our Map 1	Ref Map 2	Ref Map 3	Ref Map 4	Ref Map 5	Ref Map 6
5	A1AT4 MOUSE	Q00897	46.1	5.2	162	51	1232.74 2003.04 2327.09 3498.80	CHCA DHB	17	not present	<i>not present</i>	<i>not present</i>	<i>not present</i>	present
	A1AT5 MOUSE	Q00898	46	5.4	105	35	1232.71 2327.09 2405.17	CHCA DHB	12	not present	<i>not present</i>	<i>not present</i>	<i>not present</i>	present
	A1AT6 MOUSE	P81105	46	5.2	161	47	981.56 1137.66 1232.70 2003.04 2327.09 2405.17 3498.80	CHCA DHB	16	2	not present	8	not present	present
6	ANT3 MOUSE	P32261	52.5	6.1	298	56	1198.70 1340.69 1359.67 1700.89	CHCA DHB	29	6	not present	<i>not present</i>	<i>not present</i>	present
7	A2AP MOUSE	Q61247	55.1	5.8	169	36	1591.80 1680.81	CHCA DHB	15	3	<i>not present</i>	<i>not present</i>	<i>not present</i>	present
8	CBG MOUSE	Q06770	44.9	5	148	32		CHCA DHB	10	3	<i>not present</i>	<i>not present</i>	<i>not present</i>	present
9	SPA3K MOUSE	P07759	47	5	113	29		CHCA DHB	12	12	v	21	7 (up regulated)	present
10	A2MG MOUSE	Q61838	167	6.27	153	19	2068.21	CHCA DHB	18	25	16 (immuno depletion)	<i>not present</i>	<i>not present</i>	present

Table1...continued

No.	SwissProt entry	SwissProt accession	Mw (KDa)	PI	Mascot score	sequence coverage (%)	<i>msms (m/z)</i>	<i>matrix</i>	Our Map 1	Ref Map 2	Ref Map 3	Ref Map 4	Ref Map 5	Ref Map 6
10a	A2MG MOUSE C-term	Q61839	28	7	62	6	1031.50 1111.58 1216.61 1787.96	CHCA DHB	9	?	<i>not present</i>	13	16 (up regulated)	present
11	ADIPO MOUSE	Q60994	26.9	5.3	63	19	1504.72	DHB	5	<i>not present</i>	<i>not present</i>	<i>not present</i>	<i>not present</i>	<i>present</i>
12	AFAM MOUSE	O89020	71.5	5.5	155	31		CHCA DHB	15	1	9	not present	not present	present
13	ALBU MOUSE	P07724	70.7	5.7	426	68	1455.83 1479.70 1609.90 1882.96 1960.15 1981.98	CHCA DHB	40	26* 46'	17	48	12 (up regulated)	present
14	ALS MOUSE	P70389	67.7	6.1	97	28		DHB	13	<i>not present</i>	<i>not present</i>	<i>not present</i>	<i>not present</i>	<i>present</i>
15	CPN2 MOUSE	Q9DBB9	61.3	5.5	131	25		CHCA	10	not present	not present	not present	not present	present
16	ANGL6 MOUSE	Q8R0Z6	51.4	9.2	56	16		DHB	4	not present	not present	not present	not present	not present
17	ANXA2 MOUSE	P07356	38.8	7.5	82	18		CHCA	5	not present	not present	not present	not present	not present
18	APOA1 MOUSE	Q00623	30.5	5.6	207	49	1237.67 1318.61 1331.53 1340.77	CHCA DHB	17	5* 18'	13	18	22	present

Table1...continued

No.	SwissProt entry	SwissProt accession	Mw (KDa)	PI	Mascot score	sequence coverage (%)	msms (m/z)	matrix	Our Map 1	Ref Map 2	Ref Map 3	Ref Map 4	Ref Map 5	Ref Map 6
19	APOA2 MOUSE	P09813	11.3	6.6	85	14	1193.62 1831.98	CHCA DHB	2	4'	7	3	3 (up regulated)	present
20	APOA4 MOUSE	P06728	45	5.4	223	60	1131.66 1231.61 1461.75 2023.05	CHCA DHB	21	2* 5'	15	29	6 (up regulated)	present
21	APOE MOUSE	P08226	35.9	5.6	166	51	968.52 1075.60 1599.82	CHCA DHB	21	5'	7	17	16 (up regulated)	present
22	APOC3 MOUSE	P33622	10.9	4.6	140	19	1062.46 1078.45 1987.94	CHCA	3	not present	3	3	not present	present
23	APOH MOUSE	Q01339	39.9	8.6	276	62	1325.68 1544.85 2719.48	CHCA DHB	22	7	not present	17	22 (up regulated)	present
24	CLUS MOUSE	Q06890	55.2	5.5	103	19		CHCA	11	2*	9	12	not present	present
25	<i>C1R MOUSE</i>	<i>Q8CG16</i>	<i>81.5</i>	<i>5.4</i>	<i>78</i>	<i>17</i>		CHCA	8	not present	not present	not present	not present	not present
26	CFAB MOUSE	P04186	86.3	7.2	269	37		CHCA DHB	23	3	not present	not present	not present	present
27	<i>CFAI MOUSE</i>	<i>Q61129</i>	<i>69.5</i>	<i>7.4</i>	<i>103</i>	<i>21</i>	<i>1726.85</i>	DHB	11	3	not present	not present	not present	not present
28	<i>HGFA MOUSE</i>	<i>Q9R098</i>	<i>72.9</i>	<i>6.6</i>	<i>58</i>	<i>13</i>		DHB	6	not present	not present	not present	not present	present

Table 1...continued

No.	SwissProt entry	SwissProt accession	Mw (kDa)	PI	Mascot score	sequence coverage (%)	<i>msms</i> (m/z)	<i>matrix</i>	Our Map 1	Ref Map 2	Ref Map 3	Ref Map 4	Ref Map 5	Ref Map 6
29	HPT MOUSE	Q61646	39.2	5.9	146	49	980.49 1320.74 1373.61	DHB	21	not present	11	5	14 (up and down regulated)	present
29a	HPT MOUSE	Q61646			81	11	1679.78	DHB	6	?	?	14	not present	not present
30	PLMN MOUSE	P20918	93.4	6.2	387	53	1138.46	CHCA DHB	35	8	not present	32	6	present
31	CFAH MOUSE	P06909	144	6.6	269	31		CHCA DHB	29	6	not present	18	not present	present
32	CS1A MOUSE	Q8CG14	78.3	5	66	15		DHB	6	not present	not present	not present	not present	not present
33	F13B MOUSE	Q07968	78.3	5.6	148	26		CHCA	15	not present	not present	not present	not present	present
34	CO3 MOUSE	P01027	188	6.4	312	29	1886.93	CHCA DHB	40	23* 1'	not present	not present	17 (up regulated)	present
35	CO4 MOUSE	P01029	194	7.5	123	9		CHCA	14	3	not present	not present	not present	present
36	CO9 MOUSE	P06683	63.2	5.6	80	29		DHB	14	1	not present	not present	not present	not present
37	C1QB MOUSE	P14106	27	8.6	69	20		CHCA	5	1*	not present	not present	not present	present
38	EGFR MOUSE	Q01279	138	6.5	171	16		CHCA DHB	15	not present	not present	18	not present	present
39	FIBB MOUSE	Q8K0E8	55.4	6.7	112	39		CHCA DHB	20	not present	not present	not present	not present	present
40	FINC MOUSE	P11276	276	5.4	90	8		CHCA	16	9*	not present	not present	not present	present

Table1...continued

No.	SwissProt entry	SwissProt accession	Mw (KDa)	PI	Mascot score	sequence coverage (%)	msms (m/z)	matrix	Our Map 1	Ref Map 2	Ref Map 3	Ref Map 4	Ref Map 5	Ref Map 6
41	FCN1 MOUSE	O70165	36.8	6	65	12		DHB	5	not present	not present	8	not present	not present
42	FETUA MOUSE	P29699	38.1	6	135	47	1653.75 2138	CHCA DHB	11	3	6	8	not present	present
43	FETUB MOUSE	Q9QXC1	43.5	6.2	113	30	1382.89 1159.7	CHCA DHB	14	1	5	13	not present	present
44	GPX3 MOUSE	P46412	25.6	8.3	98	45	1955	CHCA DHB	12	not present	not present	not present	not present	present
45	HA10 MOUSE	P01898	37.2	5.2	173	46	1671.86	CHCA DHB	16	3	not present	not present	not present	not present
46	HBA MOUSE	P01942	15	8	79	31	1589.82 1819.93	CHCA	5	2* 6'	not present	not present	8	present
47	HBB1 MOUSE	P02088	16	7.3	68	73	1274.72	CHCA DHB	9	not present	not present	not present	7 (up regulated)	present
48	HEMO MOUSE	Q91X72	52	7.9	188	43	1100.47 1212.63 1504.76 1516.71 1727.77 2472.12	CHCA DHB	21	14	8	25	3 (up regulated)	present
49	IGHG1 MOUSE	P01868	36.2	7.2	94	45		DHB	9	3	not present	not present	not present	not present
50	KNG1 MOUSE	O08677	74.1	6	164	29	1010.56 1060.56 1515.68	CHCA DHB	18	9	12	24	5 (up regulated)	not present
51	KLKB1 MOUSE	P26262	73.4	8.4	105	22		CHCA	14	1*	2	not present	not present	present

Table1...continued

No.	SwissProt entry	SwissProt accession	Mw (KDa)	PI	Mascot score	sequence coverage (%)	msms (m/z)	matrix	Our Map 1	Ref Map 2	Ref Map 3	Ref Map 4	Ref Map 5	Ref Map 6
52	KV3A1/2/4 MOUSE	P01654	12	5	116	16	1616.89 1855.04	CHCA DHB	2	not present	not present	not present	not present	present
	KV3AD MOUSE	P01665	12	4.9	54	44	1155.46 1616.89 1855.04	CHCA DHB	4	not present	not present	not present	not present	present
53	KV5AB MOUSE	P01644	12	7.9	88	17	1028.56 1926.92 2455.35	CHCA DHB	3	not present	not present	not present	not present	not present
	KV5J MOUSE	P01645	11.9	9.2	93	16	1926.81	CHCA DHB	1	not present	not present	not present	not present	present
54	KV3N MOUSE	P01666	12	4.5	58	53		DHB	3	not present	not present	not present	not present	present
55	MUC MOUSE	P01872	50	6.6	184	30	1330.78 1603.91	CHCA DHB	14	4	not present	not present	not present	not present
56	MUG1 MOUSE	P28665 (Q80XE6)	166.4	6	168	20		CHCA DHB	24	12	not present	not present	not present	present
57	PHLD MOUSE	O70362	93.8	6.6	151	23		CHCA DHB	20	1	not present	not present	not present	present
58	PON1 MOUSE	P52430	34.6	5	117	32	1853.9	CHCA DHB	8	2	not present	not present	not present	present
59	PROP MOUSE	P11680	50	8.4	87	21		CHCA	8	not present	not present	not present	not present	present
60	RETP MOUSE	Q00724	23.5	5.7	138	59	1226.63 1360.58 1789.84 2079.88	CHCA DHB	15	1	not present	not present	not present	present
61	SAMP MOUSE	P12246	26.4	6	88	38	2133.03	CHCA DHB	8	1	8	8	not present	present

Table1...continued

No.	SwissProt entry	SwissProt accession	Mw (KDa)	PI	Mascot score	sequence coverage (%)	<i>msms</i> (m/z)	<i>matrix</i>	Our Map 1	Ref Map 2	Ref Map 3	Ref Map 4	Ref Map 5	Ref Map 6
62	THRB MOUSE	P19221	71.6	6	156	28	1189.56	CHCA DHB	19	4	not present	26	9 (up regulated)	present
63	TRFE MOUSE	Q92111	78.8	7	308	51	1171.61 1419.86 1656.81 1990.82 2007.94	CHCA DHB	38	39* 1'	?	26	not present	present
64	KAC MOUSE	P01837	11.9	5	91	87	990.51	CHCA DHB	8	not present	not present	not present	not present	not present
65	ZA2G MOUSE	Q64726	35.4	5.8	173	55	1274.60 1318.81 1409.72 1610.74	CHCA DHB	15	1	not present	19	not present	present
66	VTDB MOUSE	P21614	55.1	5.4	266	44	1051.6 1303.77 2441.13	CHCA DHB	24	3	12	31	not present	present
67	TTHY MOUSE	P07309	15.9	5.8	122	67	1382.62 1554.89 2438.17 2517.22	CHCA DHB	8	4* 1'	10	9	not present	present
68	GELS MOUSE	P13020	86.3	5.8	233	39	1254.75 1275.73	CHCA DHB	22	6	not present	19	not present	present
69	VTNC MOUSE	P29788	55.6	5.7	82	23		CHCA DHB	10	2	not present	not present	not present	present
70	GCAB MOUSE	P01864	37	8.5	31.5	5	1913.84	DHB	1	not present	not present	not present	not present	not present
71	GCB MOUSE	P01866	37.3	7.2	79	30	1778.87	CHCA DHB	8	not present	not present	not present	not present	not present

Table1...continued

No.	SwissProt entry	SwissProt accession	Mw (KDa)	pI	Mascot score	sequence coverage (%)	msms (m/z)	matrix	Our Map 1	Ref Map 2	Ref Map 3	Ref Map 4	Ref Map 5	Ref Map 6
72	LAC1 MOUSE	P01843	11.7	5.9	70	61		DHB	4	not present	not present	not present	not present	not present
73	LAC2 MOUSE	P01844	11.4	5.9	70	89		DHB	5	not present	not present	not present	not present	present
74	ACTG MOUSE	P63260	42.1	5.3	188	53	1198.75 1790.93 1954.14	CHCA DHB	16	not present	not present	not present	not present	not present
	ACTB MOUSE	P60710	42	5.3	171	49	1198.75 1790.93 1954.14	CHCA DHB	15	not present	not present	not present	not present	not present
75	APC MOUSE	Q61315	313	7.4	53	6		CHCA	15	not present	not present	not present	not present	present
76	CT160 MOUSE	Q8VCC6	22	9.5	56	20		CHCA	5	not present	not present	not present	not present	not present
77	CUL1 MOUSE	Q9WTX6	90.3	8.2	62	15		CHCA	7	not present	not present	not present	not present	not present
78	ESTN MOUSE	P23953	61.4	5.1	168	37	911.45	CHCA DHB	21	12	7	not present	not present	present
79	ITIH2 MOUSE	Q61703	106	6.8	150	24	1337.73	CHCA DHB	14	2	not present	not present	not present	present
80	ITIH4 MOUSE	9055252	104.8	6	133	20		CHCA	17	not present	not present	18	not present	not present
81	K2C6B MOUSE	Q9Z331	60.5	8.5	76	29		CHCA DHB	15	not present	not present	not present	not present	not present
82	LIFR MOUSE	P42703	123.8	5.7	151	19		DHB	15	not present	not present	22	not present	present

Table1...continued

No.	SwissProt entry	SwissProt accession	Mw (KDa)	pI	Mascot score	sequence coverage (%)	msms (m/z)	matrix	Our Map 1	Ref Map 2	Ref Map 3	Ref Map 4	Ref Map 5	Ref Map 6
83	MBL1 MOUSE	P39039	25.8	7.5	100	27	1544.89	CHCA	9	<i>not present</i>	<i>not present</i>	<i>not present</i>	8 (up regulated)	<i>present</i>
84	MBL2 MOUSE	P41317	26.3	5	70	29	1323.60 1522.72 1766.83	CHCA DHB	6	2	<i>not present</i>	8	<i>not present</i>	<i>not present</i>
85	OST5 MOUSE	Q8BSL4	40.7	9.7	70	23		CHCA	6	<i>not present</i>	<i>not present</i>	<i>not present</i>	<i>not present</i>	<i>not present</i>
86	SYT2 MOUSE	P46097	47.7	8.2	61	19		CHCA	6	<i>not present</i>	<i>not present</i>	<i>not present</i>	<i>not present</i>	<i>present</i>
87	TPH1 MOUSE	P17532	51.9	6	59	17		CHCA	7	<i>not present</i>	<i>not present</i>	<i>not present</i>	<i>not present</i>	<i>not present</i>
88	KPYM MOUSE	P52480	58	7	53	30		DHB	12	<i>not present</i>	<i>not present</i>	<i>not present</i>	<i>not present</i>	<i>not present</i>
89	DYN2 MOUSE	P39054	98	7	68	12		CHCA DHB	9	<i>not present</i>	<i>not present</i>	<i>not present</i>	<i>not present</i>	<i>not present</i>
90	GAB2 MOUSE	Q9Z1S8	73.6	8.5	33	2	1794.8	DHB	1	<i>not present</i>	<i>not present</i>	<i>not present</i>	<i>not present</i>	<i>present</i>

Table 1: Mouse serum protein map

Mouse serum proteins identified by us in serum from C57Bl/6 mice (“Our Map”) in comparison with previous mouse serum maps (see Ritorto, Borlak, Proteome Science 2008, PMID: PMC2563006). In **bold**, we highlighted the proteins identified only with tandem MS (LIFT-MS/MS technology). For full details, please refer to the PMID: PMC2563006.

Table 2

No	SwissProt entry	SwissProt accession	putative PTM	Subcellular location	Mw (KDa)	pI	RMS error (ppm)	matrix	SwissSprot	NCBIInr	MSDB	Nr of matched peptides (Mascot)	Nr of matched peptides (PeptideMap)
1	ANGL6 MOUSE	Q8R0Z6	G	Secreted; highly expressed in the liver	51.4	9	38	DHB	56	58	55	4	3
2	ANXA2 MOUSE	P07356	P	Secreted, extracellular space, extracellular matrix, basement membrane. Melanosome	38.8	8	45	CHCA	82	81	82	5	3
3	C1R MOUSE	Q8CG16	G	Secreted	81.5	5	15	DHB CHCA	78	78	78	8	5
4	CS1A MOUSE	Q8CG14	G	Predominantly expressed in liver	78.3	5	11	DHB	66	66	66	6	5
5	LAC1 MOUSE	P01843		Secreted	11.7	6	4	DHB	70	70	70	4	3
6	ACTG MOUSE	P63260	P	Cytoplasm, cytoskeleton	42.1	5	28	DHB CHCA	188	188	188	16	15
7	CT160 MOUSE	Q8VCC6			22	10	35	CHCA	55	56	56	5	4
8	CUL1 MOUSE	Q9WTX6	G	Embryo fibroblasts and embryo preadipocytes	90.3	8	49	CHCA	62	62	62	7	6
9	K2C6B MOUSE	Q9Z331	P	Expressed in adult epithelia	60.5	8.5	36	DHB CHCA	60	60	60	11	11
10	OST5 MOUSE	Q8BSL4	G	Golgi apparatus membrane; Single-pass type II membrane protein	40.7	10	35	CHCA	70	70	70	6	5
11	TPH1 MOUSE	P17532	P	Cytoplasmic enzyme, pineal gland	51.9	6	30	CHCA	57	57	57	7	5
12	KPYM MOUSE	P52480	P	Liver, red cells, muscles, brain	58	7	39	DHB	53	53	53	11	10
13	DYN2 MOUSE	P39054	P	Cytoplasm	98	7	51	DHB CHCA	68	68	68	9	9

Table 2: Newly identified proteins

Table 3

Protein Name	Statistical validation a)			Mass spectrometer validation b)			Immuno validation c)		
	t-test	Mann	PLS	MS/MS peptide-mass observed	PFF Score	Sequence (AA)	Western Blot	WB Semi-Quantitative (T/C)	Immunohistochemistry
AFAM MOUSE	P<.05	P>.05	P<.01	-	-	-	↓ (human)	0.21±2.4 (h)	
FETA MOUSE	P<.05	P<.05	P>.05	-	-	-	↑ (mouse)	1.81±0.45 (m)	
ANT3 MOUSE	P<.05	P<.05	P>.05	1359.78	59	DIPVNPLCIYR (47-57)			
				1700.94	63	LQPLDFKENPEQSR (203-216)			
				1075.58	59	LQAEIFQAR (262-270)			up
APOE MOUSE	P<.05	P<.05	P>.05	1599.78	87	ELEEQLGPVAEETR (87-100)		2.29±0.13 (m)	
				968.52	67	LGPLVEQGR (191-199)	↑ (mouse, human)	1.95±0.68 (h)	
				1599.77	105	ELEEQLGPVAEETR (87-100)			
APOE MOUSE	P<.05	P<.01	P>.05	1759.84	56 (ox)	NEVHMLGQSTEEIR (130-144)			
				1599.77	44	ELEEQLGPVAEETR (87-100)	only T (mouse)	Only T (m)	
APOE MOUSE	P<.05	P<.01	P>.05					2.20±0.61 (m)	
APOM MOUSE	P<.05	P<.01	P<.05	938.42	27	ETGQGYQR (138-145)	↑ (human)	1.98±0.29 (h)	

Table 3....continued

Protein Name	Statistical validation a)			Mass spectrometer validation b)			Immuno validation c)		
	t-test	Mann	PLS	MS/MS peptide-mass observed	PFF Score	Sequence (AA)	Western Blot	WB Semi-Quantitative (T/C)	Immunohistochemistry
GPX3 MOUSE	P<.05	P<.01	P<.01	1955.01	41	YVRPGGGFVPNFQLFEK (121-137)			
				1928.11	65	FNPVTGEVPPRYPLDAR (208-224)			
				2448.07	151	ELGSPPGISLETIDAAFSCPGSSR (346-369)			
				1727.77	64	GECQSEGLVFFQGNR (151-165)			
HEMO MOUSE	P<.01	P<.01	P<.01	2472.15	90	LFQEEFPGIPYPPDAAVECHR (130-150)			↑ (cyto)
				1516.7	45	GATYAFTGSHYWR (270-282)			
				1504.79	28	WKNPITSVDAAFR (90-102)			
				1212.64	47	FNPVTGEVPPR (208-218)			
				1100.47	41	DYFVSCPGR (225-233)			
				1855.85	66	GECQSEGLVFFQGNRK (151-166)			
HPT MOUSE	P<.01	P<.01	P<.01	1373.61	65	SCAVAEGVYVR (321-332)			
				1832.93	68	VMPICLPSKDYIAPGR (203-218)			
				980.53	34	VGIVSGWGR (219-227)			
				920.4	56	GSFPWQAK (112-119)			
HPT α MOUSE	P<.05	P<.05	P<.01	1679.85	63	LRAEGDGVYTLNDEK (58-72)			
				1387.68	58	LPECEAVCGKPK (83-94)			
MUP MOUSE	P<.01	P<.01	P>.05	-	-	-	↓ (mouse)	<0.01 (m)	↑ (m, cyto) ↓ (h)

Table 3...continued

Protein Name	Statistical validation a)			Mass spectrometer validation b)			Immuno validation c)		
	t-test	Mann	PLS	MS/MS peptide-mass observed	PFF Score	Sequence (AA)	Western Blot	WB Semi-Quantitative (T/C)	Immunohistochemistry
PHLD MOUSE	P<.05	P<.05	P>.05	-	-	-	↑ (mouse, human)	8.29±0.33(m) 2.21±0.93 (h)	
PIGR MOUSE	P<.05	P<.05	P>.05	1282.66	19	AIPNPGPFANER (603-614)	T(mouse, human)	T (human HCV)	
PON1 MOUSE	P<.05	P<.01	P<.01	1853.84	82	IFFYDAENPPGSEVLR (209-305)	↑ (mouse)	2.23± 0.23(m) 0.77± 0.36(h)	↑
				1226.73	71	YWGVASFLQR (108-117)			
				1360.67	57	QRQEELCLER (172-181)			
RETBP MOUSE	P<.01	P<.01	P<.01	1789.83	63	WIEHNGYCQSRPSR (185-198)	↑(mouse)	7.19±0.29 (m) 0.84±0.29 (h)	↑
				2079.98	132	LQNLDTGCADSYFVFSR (140-157)			
				-	-	-			
SAMP MOUSE	P<.05	P<.05	P<.05	-	-	-	↑ (mouse, human)	6.00±0.29 (m) 5.63±0.76 (h)	↑
SPA3K/M MOUSE	P<.01	P<.05	P<.01	2270.23	28	AVLDVAETGTEAAAATGVIGGIRK (361-384)			
				2366.01	66	ISFDPQDTFESEFYLDKQR (218-236)			

Table 3....continued

Protein Name	Statistical validation a)			Mass spectrometer validation b)			Immuno validation c)		
	t-test	Mann	PLS	MS/MS peptide-mass observed	PFF Score	Sequence (AA)	Western Blot	WB Semi-Quantitative (T/C)	Immunohistochemistry
TTHY MOUSE	P<.05	P<.01	P>.05	2517.24	178	TLGISPFHEFADVFTANDSGHR (101-123)		T(m)	
				869.45	41	FVEGVYR (84-90)			
				1382.63	91	TSEGSWEPFASGK (56-68)			↑
				2438.26	193	TAESGELHGLTTDEKFVEGVYR (69-90)	↑(mouse)		
TTHY MOUSE	P<.05	P<.05	P<.05	1382.63	54	TSEGSWEPFASGK (56-68)			
				2597.36	43	HYTIAALLSPYSYSTTAVVSNPQN (124-147)		8.92±0.04 (m) 0.94±0.29 (h)	↑
				2438.26	135	TAESGELHGLTTDEKFVEGVYR (69-90)			

Table 3: Methods of validations used in the present work

The 2-DE analysis was validated by bioinformatics (PDQuest™) with univariate and multivariate methods available into the software package (a). The MS spectra identifications were confirmed by Tandem MS (b). The regulation of the proteins were further validated by immunoassays (Western Blot and Immunohistochemistry).

Table 4 New identified regulation of proteins in HCC bearing AAT-c-Myc transgenic mice

Nr	Protein Name	Swiss-Prot name	T/C ¹	serum/tissue	Gene	T/C ¹	OncoDB (HCC) ²	E-box ³	Matrices ⁴
1	Afamin	AFM_MOUSE	↓	serum	Afm	↓	↓ in tissue		
2	Antithrombin III	ANT3_MOUSE	↑	serum	Serpinc1	↓ (12)	↓ (gene)	959(+) cCACCTggcc	Ebox
3	Transthyretin	TTHY_MOUSE	↑	serum/tissue	Ttr	↓	↓ (gene)	247(-) ggtcAGGTGg	Ebox
4	Phosphatidylinositol phospholipase D	PHLD_MOUSE	↑	serum	Gpld1				
5	Polymeric immunoglobulin receptor	PIGR*_MOUSE	only in tumor	serum	PigR			890(+) tggcagtcACGTgatctggc 890(-) tggcagtcACGTgatctggc 894(-) agtcACGTGa 945(-) agccAGGTGc	Myc/Max Myc/Max Ebox Ebox
6	Retinol binding protein 4	RET4_MOUSE	↑	serum/tissue	Rtbp4		↓ (mRNA)	1031(+) tCCACGcgcg	Myc/Max B
7	3-hydroxyisobutyrate dehydrogenase, mitochondrial	3HIDH_MOUSE	↓	tissue	Hibadh	↓ (12)	type 2 ↓ (gene)		
8	Elongation factor 1-delta	E1FD_MOUSE	↑	tissue	Eef1d	↑ (6-12)	in rat	1080(-) ggcACGTGc	Ebox
9	Protein ETHE1	ETHE1_MOUSE	↓	tissue	Ethe1	↓ (12)		730(+) agccgaaCACGTgtttct 730(-) agccgaacACGTGtttct 734(-) gaacACGTGt 736(+) aCACGTgtt	Myc/Max Myc/Max Ebox Ebox
10	Galactokinase 1	GALK1_MOUSE	↑	tissue	Galk1	↑	↓ (gene)/ ↑ (gene)	949(+) tccgcgCACGTggctccgc 949(-) tccgcccACGTGgctccgc 953(-) cgccACGTGg 954(+) gCCACGtggc 954(-) gccacGTGGc 955(+) cCACGTggct	Myc/Max Myc/Max Ebox Myc/Max B Myc/Max B Ebox
11	Isocitrate dehydrogenase [NAD] subunit alpha, mitochondrial	IDH3A_MOUSE	↑	tissue	ldh3a	↑ (6-12)		1038(-) tccgCGTGGg	Myc/Max

Table 4 ...continued...

Nr	Protein Name	Swiss-Prot name	T/C ¹	serum/tissue	Gene	T/C ¹	OncoDB (HCC) ²	E-box ³	Matrices ⁴
12	Protein canopy homolog 2	MSAP_MOUSE	↑	tissue	Cnpy2	slightly ↑ (12)		873(+) gggtggcACGTgaaccaat 873(-) gggtggcACGTgaaccaat 877(-) gggtcACGTGa	Myc/Max Myc/Max Ebox
13	Selenium binding protein 1/2	SBP1/2_MOUSE	↓	tissue	Selenbp1/2	↓ (12)		666(+) aCACCTgtgc 810(+) aCACCTgtgc	Ebox Ebox
14	Indolethylamine N-methyltransferas	TEMT_MOUSE	↓	tissue	Inmt	strongly ↓ (12)		732(+) cCACATgcca	Ebox
15	Actin-related protein 3	ARP3_MOUSE	↓	tissue	Actr3	slightly ↑ (12)		91(-) cagcATGTGg	Ebox
16	Serine/threonine-protein phosphatase 2A	2AAA_MOUSE	↓	tissue	Ppp2r1a				
17	3-hydroxylantranilate 3,4 dioxygenase	3HAO_MOUSE	↓	tissue	Haa0		↓ (gene)	782(+) cCACCTgtgg	Ebox
18	Abhydrolase domain-containing protein 14B	ABHEB_MOUSE	↑↓	tissue	Abhd14b			117(+) gCACCTgctg 524(+) aactgtaCACGTgtgcccc 524(-) aactgtacACGTgtgcccc 530(+) aCACGTgttg	Ebox Myc/Max Myc/Max Ebox
19	Activator of 90kDa heat shock protein ATPase homolog 1	AHSA1_MOUSE	↑	tissue	Ahsa1				
20	Coatomer subunit epsilon	COPE_MOUSE	↓	tissue	Cope			148(+) cCACCTgctc	Ebox
21	Cytochrome c oxydase subunit 5A, mitochondrial	COX5A_MOUSE	↓	tissue	Cox5a		↑↓ (gene)	261(+) cCACCTgatg 447(-) gatcATGTGa	Ebox Ebox
22	Cytochrome c oxydase subunit 5B, mitochondrial	COX5B_MOUSE	↓	tissue	Cox5b				

Table 4 ...continued...

Nr	Protein Name	Swiss-Prot name	T/C ¹	serum/tissue	Gene	T/C ¹	OncoDB (HCC) ²	E-box ³	Matrices ⁴
23	Dynein light intermediate chain 2, cytosolic	DYI2_MOUSE	↓	tissue	Dync1i2		↓ (RT_PCR)	421(+) gCACATgcct	Ebox
24	Malate dehydrogenase, cytoplasmatic	MDHC_MOUSE	↓	tissue	Mdh1			498(-) gctcAGGTGa	Ebox
25	Phosphatidylethanol-amine binding protein 1	PEBP*_MOUSE	↑	tissue	Pbp		↓ (gene)	996(-) tgcgCGTGCC	Myc/Max B
26	Phenylalanine-4-hydroxylase	PH4H_MOUSE	↑	tissue	Pah		↓ (gene)		
27	Sulfite oxidase, mitochondrial	SUOX_MOUSE	↓	tissue	Suox			245(-) ttctCGTGGc 1044(-) tcccCGTGGc	Myc/Max B Myc/Max B
28	Ubiquitin carboxyl-terminal hydrolase isozyme L3	UCHL3_MOUSE	↑	tissue	Uchl3				

Table 4: Regulation of proteins at both protein and gene level

The table shows the regulations of serum and tissue proteins and the comparison of those results with genomic data on the same transgenic mice. Moreover, results on HCC protein/gene regulation in the literature (by oncoDB) and the search for possible c-Myc targets (presence of E-boxes on the related gene promoter) by BIOBASE software (matrices are discussed in the Applied Method section) are also shown.

Table 5

Gene	12 months (AAT-cMyc)		6 months (AAT-cMyc)		2 months (AAT-cMyc)		Note
	T/C	P	T/C	P	T/C	P	
Myc	32.05	0	7.54	0.005	7.41	0.005	HCC
RPL13a	6.26	0	3.09	0.0001	3.09	0.0093	HCC
RPL36a	2.46	0.0006	1.6	0.0069	1.77	0.007	HCC
RPL27	1.85	0.0001	1.55	0.006	1.82	0.001	HCC, c-Myc (c-DNA microarray)
MRPL30	-	-	2.18	0.0011	-	-	HCC, c-Myc (c-DNA microarray)
Rps19	4.31	0.0051	2.37	0.002	2.64	0.001	c-Myc (SAGE)
Rpl3	2.08	0.0001	-	-	-	-	c-Myc (SAGE)
Rplp1	2.24	0	1.75	0.0001	1.71	0.003	c-Myc (c-DNA microarray)
Rpl7	2.15	0.0001	1.66	0.0002	-	-	c-Myc (c-DNA microarray)
Rpl19	1.99	0	1.23	0.005	1.64	0.004	c-Myc (c-DNA microarray)
Rps15a	1.91	0.0017	1.74	0.0003	-	-	c-Myc (c-DNA microarray)
Rpl6	1.83	0	1.89	0.0002	1.64	0.0005	c-Myc (c-DNA microarray)
Rpl22l1	3.09	0.0006	2.55	0	2.9	0.016	-
Rpl10a	2.93	0	2.13	0.005	1.91	0.031	-
Rpsa	2.54	0.0004	1.84	0.0012	2.19	0.005	-
Rps5	2.46	0	1.69	0.0001	1.84	0	-
Rps11	2.18	0	1.77	0.0001	1.72	0.03	-
Rpl18	2.17	0	1.88	0	1.64	0.008	-
Rpl37	1.93	0	1.65	0.0005	/	/	-
Rps3	1.91	0.0005	-	-	1.61	0.0003	-
Rpl28	1.85	0.0011	-	-	1.63	0.018	-
Rpl8	1.84	0.0001	-	-	1.64	0.0003	-

Table 5: Ribosomal protein regulation

Regulation of transcription of several ribosomal proteins is shown. Some of them were already reported as HCC related or Myc targets. Moreover, we identified other n=10 genes regulated in our study on c-Myc transgenic mice which develop HCC (gray part of the Note section).

Table 6

Function	Protein SwissProt	T/C (FC>1.8; p<0.05)	MS/MSMS	Protein Name
Cell progression and proliferation				
	1 H2A1	~10	MS/MSMS	Histone H2A type 1
	2 14-3-3T/Z/B/G	100	MS/MSMS	14-3-3 protein zeta/delta/beta
	3 H2B2	3.5	MS	Histone H2B type 1-M
	4 14-3-3E	2.7	MS/MSMS	14-3-3 protein epsilon
	5 NPM	2.5	MS	Nucleophosmin
	6 UCHL3	2.48	MS/MSMS	Ubiquitin carboxyl-terminal hydrolase isozyme L3
	7 EF1D	2.53	MS/MSMS	Elongation factor 1-delta
	8 AHSA1	3.2	MS	Activator of 90 kDa heat shock protein ATPase homolog 1
	9 HS90A/B	1.8	MS	Heat shock protein HSP 90-alpha/beta
	10 HSP70	1.8	MS	Heat shock cognate 71 kDa protein
Metabolism				
	11 PRDX6	5	MS/MSMS	Peroxiredoxin-6
	12 BLVRB	3.2	MS/MSMS	Flavin reductase
	13 PRDX3	2.7	MS/MSMS	Thioredoxin-dependent peroxide reductase, mitochondrial
	14 ENOA	2.6	MS	Alpha-enolase
	15 PRDX2	2.6	MS	Peroxiredoxin-2
	16 PPIA	2.25	MS	Peptidyl-prolyl cis-trans isomerase A
	17 F16P1	0.46	MS/MSMS	Fructose-1,6-bisphosphatase 1
	18 COX5A	0.6	MS	Cytochrome c oxidase subunit 5A, mitochondrial

Table 6...continued

Function	Protein SwissProt	T/C (FC>1.8; p<0.05)	MS/MSMS	Protein Name
	19 SUOX	0.4	MS/MSMS	Sulfite oxidase, mitochondrial
	20 COX5B	0.4	MS/MSMS	Cytochrome c oxidase subunit 5B, mitochondrial
	21 CYB5M	0.18	MS	Cytochrome b5 outer mitochondrial membrane isoform precursor
Oxidative stress				
	22 LAM1	3.4	MS	Lamin-B1
	23 TXNL1	2.53	MS/MSMS	Thioredoxin-like protein 1
	24 PARK7	0.44	MS	Protein DJ-1
	25 NUAM	0.4	MS	NADH-ubiquinone oxidoreductase 75 kDa subunit, mitochondrial
	26 NUGM	0.4	MS	NADH dehydrogenase [ubiquinone] iron-sulfur protein 3, mitochondrial
	27 SBP1/2	0.38	MS/MSMS	Selenium-binding protein 1 and 2
	28 2AAA	0.37	MS/MSMS	Serine/threonine-protein phosphatase 2A 65 kDa regulatory subunit A alpha isoform
	29 GPX1	0.2	MS/MSMS	Glutathione peroxidase 1
GSH metabolism				
	30 GSH0	4	MS/MSMS	Glutamate--cysteine ligase regulatory subunit
	31 GSTM1	2.7	MS	Glutathione S-transferase Mu 1
	32 GSTP1	2.7	MS	Glutathione S-transferase P 1
	33 IDHC	2	MS	Isocitrate dehydrogenase [NADP] cytoplasmic
Nucleotide biosynthesis & DNA Metabolism				
	34 OAT	100	MS	Ornithine aminotransferase, mitochondrial
	35 GLNA	4.8	MS/MSMS	Glutamine synthetase

Table 6...continued

Function	Protein SwissProt	T/C (FC>1.8; p<0.05)	MS/MSMS	Protein Name
	36 OTC	0.58	MS	Ornithine carbamoyltransferase, mitochondrial
	37 CPSM	0.4/0.7	MS/MSMS	Carbamoyl-phosphate synthase [ammonia], mitochondrial
	38 FTHFD	0.32	MS/MSMS	10-formyltetrahydrofolate dehydrogenase
	39 ETHE1	0.3	MS/MSMS	Protein ETHE1, mitochondrial
	40 ARG1	0.2	MS/MSMS	Arginase-1
Serum study				
	41 RETBP*/**	9.16	MS/MSMS	Retinol-binding protein 4
	42 TTHY*/**	2.77	MS/MSMS	Transthyretin
	43 MUP1	0.2	MS/MSMS	Major urinary protein 1
	44 MUP2-6-8*/** (GPX3)*/** (APOE)	0	MS/MSMS	Major urinary protein 2-6-8 (Glutathione peroxidase 3) Apolipoprotein E
Fat metabolism and transport				
	45 APOA2	8.64	only MSMS	Apolipoprotein A2
	46 APOE	4.7	MS/MSMS	Apolipoprotein E
	47 APOA1	1.8	MS/MSMS	Apolipoprotein A1
	48 FABPL	0.46	MS	Fatty acid-binding protein, liver
Metastasis				
	49 MSAP	5.44	MS/MSMS	Protein canopy homolog 2
	50 CATB	4.34	MS/MSMS	Cathepsin B
	51 CLIC1	3	MS/MSMS	Chloride intracellular channel protein 1
	52 GDIR	3.45	MS	Rho GDP-dissociation inhibitor 1
	53 COPE	0.33	MS	Coatomer subunit epsilon
Other				
	54 NAGK	4.9	MS	N-acetyl-D-glucosamine kinase
	55a ABHEB (C11B)	2.58	MS/MSMS	Abhydrolase domain-containing protein 14B
	56 IDH3A	2.07	MS/MSMS	Isocitrate dehydrogenase [NAD] subunit alpha, mitochondrial
	57 GALK1	2.07	MS/MSMS	Galactokinase 1
	58 PEBP1	2.13	MS/MSMS	Phosphatidylethanolamine-binding protein 1
	55b ABHEB	0.48	MS/MSMS	Abhydrolase domain-containing protein 14B

Table 6...continued

Function	Protein SwissProt	T/C (FC>1.8; p<0.05)	MS/MSMS	Protein Name
	59 CAH3	0.56	MS/MSMS	Carbonic anhydrase 3
	60 PH4H	0.46	MS/MSMS	Phenylalanine-4-hydroxylase
	61 OPLA	0.46	MS	5-oxoprolinase
	62 3HIDH	0.36	MS/MSMS	3-hydroxyisobutyrate dehydrogenase, mitochondrial
	63 MDHC	0.57	MS/MSMS	Malate dehydrogenase, cytoplasmic
	64 GNMT	0.44	MS	Glycine N-methyltransferase
	65 RGN	0.4	MS/MSMS	Regucalcin
	66 DOPD	0.38	MS	D-dopachrome decarboxylase
	67 DYI2	0.37	MS	Dynein light intermediate chain 2, cytosolic
	68 ARP3	0.42	MS/MSMS	Actin-related protein 3
	69 FTCD	0.34	MS/MSMS	Formimidoyltransferase-cyclodeaminase
	70 (TEMT) INMT	0.14	MS/MSMS	Indolethylamine N-methyltransferase
	71 3HAO	0.47	MS/MSMS	3-hydroxyanthranilate 3,4-dioxygenase
	72 SARDH	0.37	MS	Sarcosine dehydrogenase, mitochondrial
	73 HA10	4	MS	H-2 class I histocompatibility antigen, Q10 alpha chain
	74 LEG1	1.81	MS/MSMS	Galectin-1/Beta-galactoside-binding lectin L-14-I
	75 DHSO	0.01	MS	Sorbitol dehydrogenase

Table 6: All regulated proteins in mouse liver tissue (red: up-regulated; green: down-regulated).

Table 7

Function	Gene Name	Locus ID	mouse						human hepatocytes						Protein expression (mouse)
			2 months		6 months		12 months		steatosis		NASH				
			T/C	p-value	T/C	p-value	T/C	p-value	T/C	p-value	T/C	p-value			
<i>Expression</i>	Myc	17869	7.41	0.0045	7.54	0.0046	32.049	0	MYC	4609	-	-	-	-	
	Gpld1	14756	0.75	0.069	0.77	0.069	-	-	GPLD1	2822	-	-	0.78	0.034	
	Pld1	18805	-	-	-	-	0.47	0.021	PLD1	5337	-	-	-	-	
	Pld2	-	-	-	-	-	-	-	PLD2	5338	1.36	0.02	1.32	0.039	
<i>Regulation PLD activity</i>	Arhgdia	192662	-	-	-	-	1.55	0.037	ARHGDIS	396	1.35	0.02	1.38	0.42	
	RalA	56044	1.34	0.35	-	-	1.56	0.04	RALA	5898	-	-	-	-	
	Pepb1	23980	-	-	1.36	0.055	1.53	0.069	PEBP1	5037	2.15	0.096	-	-	
<i>Myc stabilization</i>	Ppp2r1a	51792	-	-	-	-	-	-	PPP2R1A	-	-	-	-	-	
	Ppp2r1b	73699	-	-	-	-	-	-	PPP2R1B	5519	-	-	0.57	0.047	
<i>PA production</i>	Ppap2a	19012	-	-	0.64	0.07	0.237	0.0007	PPAP2A	8611	0.50	0.098	-	-	
<i>AdoMet & NASH</i>	Inmt	21743	-	-	-	-	0.076	0.0001	INMT	11185	-	-	0.71	0.083	
	Gnmt	14711	0.82	0.042	-	-	0.28	0.0002	GNMT	27232	0.44	0.06	0.52	0.03	
<i>Oxidative stress</i>	Gpx1	14775	-	-	1.47	0.036	-	-	GPX1	2876	-	-	-	-	
	Gpx3	14778	-	-	-	-	2.06	0.031	GPX3	2878	-	-	1.25	0.051	
	Gpx4	625249	-	-	-	-	1.85	0.0001	GPX4	-	-	-	1.16	0.063	
	Blvrb	233016	-	-	-	-	-	-	BLVRB	645	-	-	-	-	
<i>HDL turn-over</i>	Apoa1	11806	-	-	-	-	-	-	APOA1	335	-	-	-	-	
	Apoa2	11807	-	-	-	-	-	-	APOA2	336	-	-	1.21	0.061	
	Apoa4	11808	-	-	-	-	5.82	0.0001	APOA4	337	1.47	0.66	1.35	0.69	
	ApoE	11816	-	-	-	-	-	-	APOE	348	-	-	-	-	
	Apom	55938	-	-	-	-	0.21	0.005	APOM	55937	0.5	0.26	-	-	
	Pon1	18979	-	-	-	-	-	-	PON1	5444	-	-	-	-	
	Lcat	16816	0.67	0.02	0.61	0.03	0.49	0.0005	LCAT	3931	-	-	0.63	0.15	

Table 7: Gene expression comparison

Protein genes related to GPI-PLD expression and activity have been compared between c-Myc mice (at 2-6-12 months) and human hepatocytes where NASH was induced. Moreover, we showed also the protein pattern ("*Protein expression (mouse)*")

Appendices

Appendix 1: c-Myc expression in liver tissue by IHC

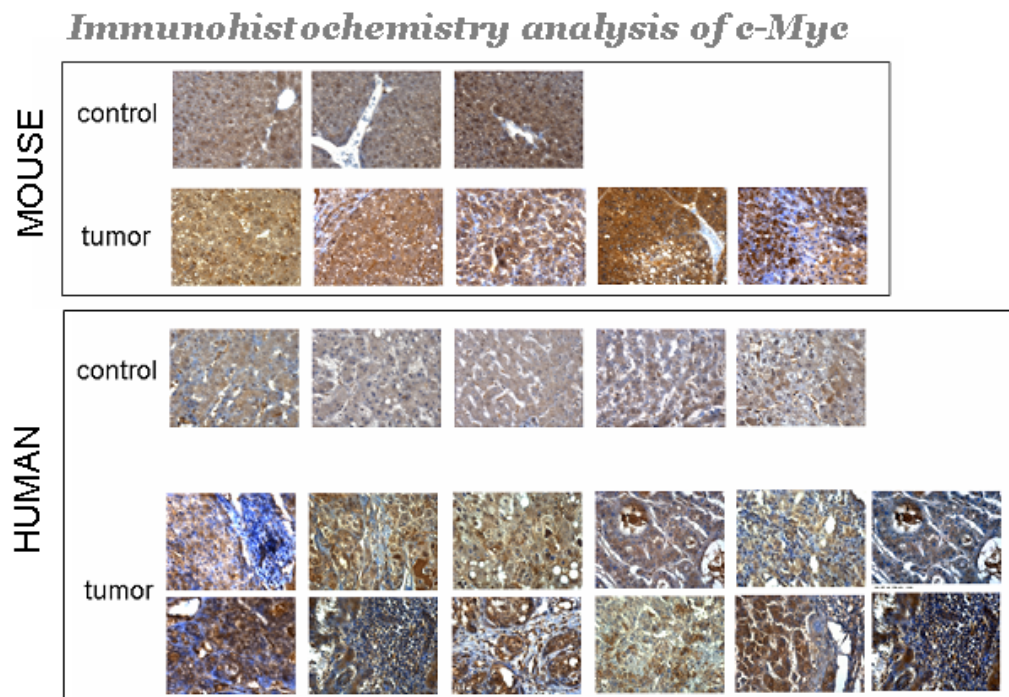

The c-Myc expression in livers from control and tumor transgenic mice (“MOUSE”) compared to the c-Myc expression in healthy –control- and HCC patients -tumor- (“HUMAN”).

Appendix 2: Immunohistochemistry of regulated proteins

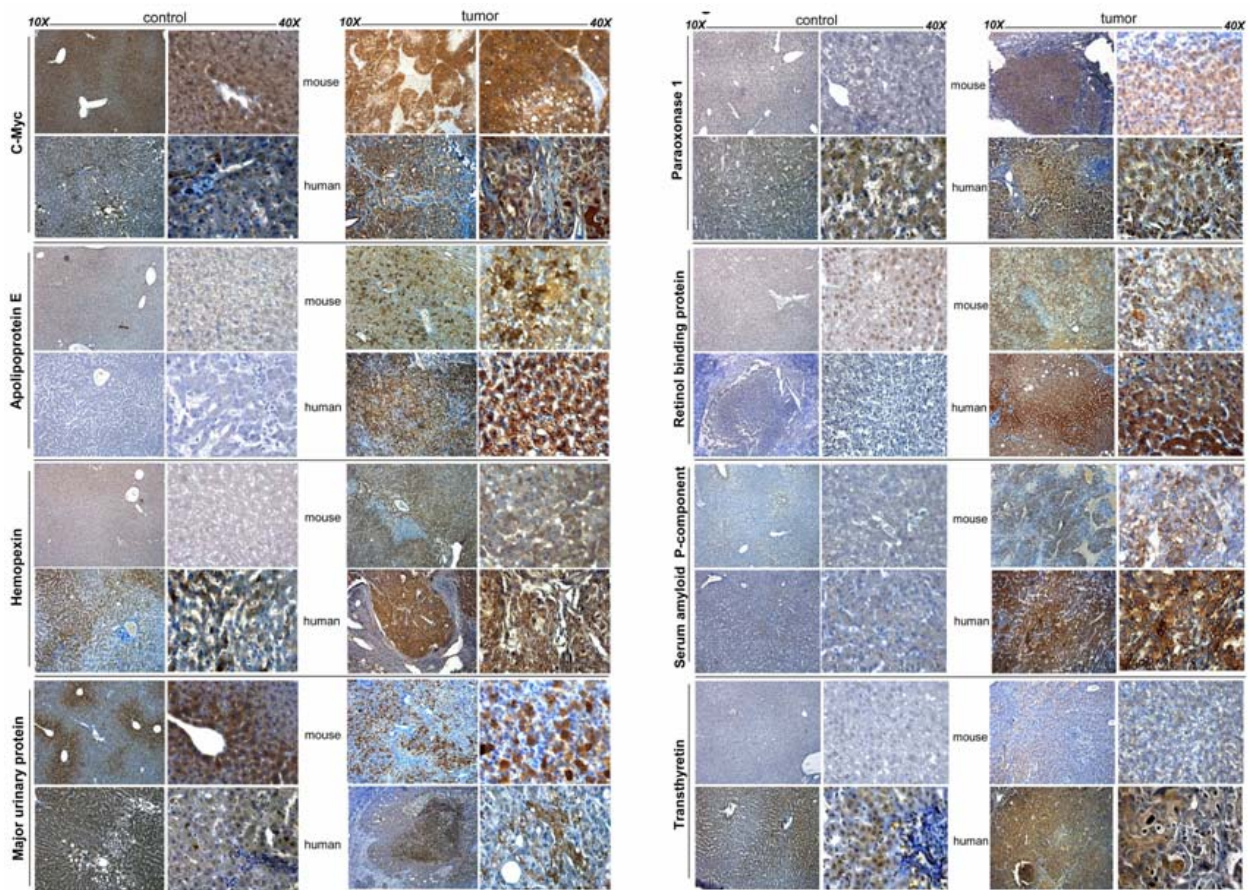

Immunohistochemistry of Apolipoprotein E, Hemopexin, Major urinary protein, Paraoxonase 1, Retinol-binding protein 4, Serum amyloid component P protein and Transthyretin. Comparison between mouse and human results in control and tumor tissues, respectively.

Appendix 3: Publication 1, title-page

Proteome Science



Research

Open Access

A simple and reliable protocol for mouse serum proteome profiling studies by use of two-dimensional electrophoresis and MALDI TOF/TOF mass spectrometry

Maria Stella Ritorto¹ and Jürgen Borlak*^{1,2}

Address: ¹Department of Drug Research and Medical Biotechnology, Fraunhofer Institute of Toxicology and Experimental Medicine, Nikolai-Fuchs-Str 1, 30625, Hanover, Germany and ²Centre for Pharmacology and Toxicology, Hanover Medical School, Carl-Neuberg-Str 1, 30625, Hanover, Germany

Email: Maria Stella Ritorto - ritorto@item.fraunhofer.de; Jürgen Borlak* - borlak@item.fraunhofer.de

* Corresponding author

Published: 12 September 2008

Received: 21 May 2008

Proteome Science 2008, 6:25 doi:10.1186/1477-5956-6-25

Accepted: 12 September 2008

This article is available from: <http://www.proteomesci.com/content/6/1/25>

© 2008 Ritorto and Borlak; licensee BioMed Central Ltd.

This is an Open Access article distributed under the terms of the Creative Commons Attribution License (<http://creativecommons.org/licenses/by/2.0>), which permits unrestricted use, distribution, and reproduction in any medium, provided the original work is properly cited.

Abstract

Background: Unravelling the serum proteome is the subject of intensified research. In this regard, two-dimensional electrophoresis coupled with MALDI MS analysis is still one of the most commonly used method. Despite some improvements, there is the need for better protocols to enable comprehensive identification of serum proteins.

Here we report a combination of two proteomic strategies, zoom in acidic and neutral part of 2-D gels and an application of two optimised matrix preparations for MALDI-MS analyses to simplify serum proteome mapping.

Results: Mouse serum proteins were separated by 2-D electrophoresis at the pH ranges 3–10 and 4–7, respectively. Then in gel tryptic digests were analysed by MALDI-MS. Notably, sample-matrix preparations consisted of either a thin-layer α -ciano-4-hydroxycinnamic acid (CHCA) matrix deposition or a matrix-layer 2,5-dihydroxybenzoic acid (DHB). This enabled an identification of 90 proteins. The herein reported method enhanced identification of proteins by 32% when compared with previously published studies of mouse serum proteins, using the same approaches. Furthermore, experimental improvements of matrix preparations enabled automatic identification of mouse proteins, even when one of the two matrices failed.

Conclusion: We report a simple and reliable protocol for serum proteome analysis that combines an optimized resolution of 2-D gels spots and improved sample-matrix preparations for MALDI-MS analysis. The protocol allowed automated data acquisition for both CHCA and DHB and simplified the MS data acquisition therefore avoiding time-consuming procedures. The simplicity and reliability of the developed protocol may be applied universally.

Background

From a disease diagnostic and drug monitoring point of view there is great interest in serum proteome mapping of humans and of laboratory animals. Indeed, various

mouse strains and genetically engineered animals are considered to be good models for human diseases as they offer unprecedented opportunities for mechanistic studies with new experimental medicines. There is hope that

Appendix 4: Publication 2, submission

ScholarOne Manuscripts https://acs.manuscriptcentral.com/acs-pr

ACS PUBLICATIONS
HIGH QUALITY. HIGH IMPACT.
Journal of Proteome Research
ACS Paragon Plus Environment

Edit Account | Instructions & Forms | Log Out | Get Help Now

SCHOLARONE™
Manuscripts

Home → Submission Confirmation You are logged in as Juergen Borlak

Submission Confirmation



Thank you for submitting your manuscript to *Journal of Proteome Research*.

Manuscript ID: pr-2010-00964y

Title: A combined serum and tissue proteomic study applied to a c-Myc transgenic mouse model of hepatocellular carcinoma identified novel disease regulated proteins suitable for diagnosis and therapeutic intervention strategies

Authors: ritorto, maria stella
Borlak, Juergen

Date Submitted: 20-Sep-2010

 Print  Return to Dashboard

ScholarOne Manuscripts™ v4.4.0 (patent #7,257,767 and #7,263,655). © ScholarOne, Inc., 2010. All Rights Reserved.
ScholarOne Manuscripts is a trademark of ScholarOne, Inc. ScholarOne is a registered trademark of ScholarOne, Inc.

 Follow ScholarOne on Twitter

[Terms and Conditions of Use](#) - [ScholarOne Privacy Policy](#) - [Get Help Now](#)

11. Februar 2011 “Just Accepted”, Journal of Proteome Research

<http://pubs.acs.org/toc/jprobs/0/ja>

Abbreviations

Abbreviation

Full-Name

AAT	Alpha-1-antitrypsin
APOA(x)	Apolipoprotein A(x)
CHCA	α -Cyano-4-hydroxycinnamic acid
C2	Ethyl-toxic cirrhosis
DDMII	Diabetes Mellitus type II
DHB	2,5-dihydroxybenzoic acid
GPI-PLD	Glycosylphosphatidylinositol-phospholipase D
HCC	Hepatocellular carcinoma
HBV	Hepatitis B virus
HCV	Hepatitis C virus
HIF-1	Hypoxia-inducible factor 1
IEF	Isoelectric focusing
IHC	Immunohistochemistry
IPGs	Focused immobilized pH gradient strips
MALDI-MS	Matrix-assisted laser desorption/ionization-Mass Spectrometry
Myc	v-myc myelocytomatosis viral oncogene homolog (avian)
NASH	Non-alcoholic steatohepatitis
PFF	Peptide fragment fingerprinting
PMF	Peptide mass fingerprinting
TFA	Trifluoroacetic acid
TOF	Time-of-Flight
WB	Western (immuno)blotting

Instruments

<i>Instrument</i>	<i>Company</i>
Alpha 1-2 LD Freeze dryer.....	Christ
Biofuge FRESCO.....	Heraeus Instruments
Buffer recirculation pump 256 BR.....	BioRad
Criterion™ Cell.....	BioRad
Criterion™ XT Precast Cell.....	BioRad
Duomax 1030.....	Heidolph instruments
Electrophoresis power supply PS 3002.....	Life Technologies
Electrophoresis-Double chamber.....	BioRad
Espresso centrifuge.....	Thermo electron corporation
Expression10000XL.....	Epson
ExQuest™ Spot Cutter.....	BioRad
External Laser Molecular Imager FX.....	BioRad
Famos (nanoHPLC).....	LC Packings
Haake k20 Circulating Refrigerator Bath	Thermo Scientific
Kodak Imager Kodak ds -IS 440CF.....	Kodak
Mini-PROTEAN® Dodeca™ Cell.....	BioRad
Mini-Protean 3 Multi-Casting Chamber.....	BioRad
Mini-PROTEAN® Tetra Cell.....	BioRad
Mini Trans-Blot® Cell.....	BioRad
MS2 Minishaker.....	IKA®
Multi-Casting Chamber.....	Biometra
Multifuge 1S.....	Heraeus Instruments
Pharos FX™ Plus Molecular Imager.....	BioRad
Pipetboy acu.....	IBS Integra Biosciences
Protean IEF Cell.....	BioRad
Power Pac 200.....	BioRad
Protean® Plus Dodeca™ Cell.....	BioRad
Rotary Vane Vacuum Pump R22.....	Vacuubrand
RTCbasic.....	IKA®
RVC (Rotations Vakuum Konzentratoren) 2-25.....	Christ
SIGMA 1-15 Microfuge.....	SciQuip Ltd
Switchos (nanoHPLC).....	LC Packings

Thermomixer compact.....Eppendorf
Sonorex Super RK 514 BH.....Bandelin
Universal Shaker (:::?).....Edmund Bühler Lab Tec GmbH
Ultimate (nanoHPLC).....LC Packings
Ultraflex II (MALDI-TOF/TOF).....Bruker Daltonics
Vortex-genie 2.....Scientific industries

Softwares & Chemicals

Softwares licenced by Fraunhofer ITEM

BioTools	Bruker Daltonics
Chromeleon.....	Dionex
FlexAnalysis.....	Bruker Daltonics
FlexControl.....	Bruker Daltonics
MATCH™	BIOBASE, Biological Databases
Origin.....	OriginLab Corporation
PDQuest™ v.....	BioRad Laboratories
ProteinScape v2.1.....	Bruker Daltonics
QuantityOne® v.....	BioRad Laboratories
Reference Manager 10.....	Thomson Scientific
Statistica.....	StatSoft

Chemicals

Anti-AFM - HPA017006.....	Atlas Antibodies®
Anti-GPLD1 –HPA012500.....	Atlas Antibodies®
Anti-PIGR – HPA012012.....	Atlas Antibodies®
Anti-PON1 – HPA001610.....	Atlas Antibodies®
Anti-APOM.....	BD Bioscience
Bio-Lyte® Ampholyte 3/10.....	BioRad Laboratories
BioRad Protein Assay.....	BioRad Laboratories
Bio- Safe™ Coomassie Stain.....	BioRad Laboratories
IPG Strips 17 cm pH 3-10NL.....	BioRad Laboratories
IPG Strips 17 cm pH 5-8 <i>linear</i>	BioRad Laboratories
IPG Strips 17 cm pH 4-7 <i>linear</i>	BioRad Laboratories
Mineral Oil.....	BioRad Laboratories
Precision Plus Protein Standards Unstained.....	BioRad Laboratories
Precision Plus Protein All Blue Standards.....	BioRad Laboratories
Protein Standard I, bovine gamma globulin, lyophilized.....	BioRad Laboratories
α-cyano-4-hydroxycinnamic acid (CHCA).....	Bruker Daltonics
2,5 dihydroxybenzoic acid (DHB).....	Bruker Daltonics

Peptide calibration standard I (~1000 Da - 4000 Da).....	Bruker Daltonics
Peptide calibration standard II (~700 Da - 3200 Da).....	Bruker Daltonics
Streptavidin horseradish peroxidase detection kit.....	Envision DAKO
Spectra™ Multicolour Broad Range Protein Ladder.....	Fermentas
MagicMark™ XP Western Protein Standard.....	Invitrogen
WesternDot™ 625 kit (W10142).....	Invitrogen
Acetone HPLC.....	J. T. Baker
Acetonitrile HPLC.....	J. T. Baker
Acetonitrile LC-MS.....	J. T. Baker
Ethanol HPLC.....	J. T. Baker
Methanol HPLC.....	J. T. Baker
Methanol LC-MS.....	J. T. Baker
Water HPLC.....	J. T. Baker
2-Butanol.....	Merck
PVDF-membrane.....	Millipore
Benzonase/nuclease.....	Novagen
Western Lightning Chemiluminescence Reagent Plus.....	Perkin Elmer
Sequencing grade modified Trypsin.....	Promega
Ammonium sulphate (APS).....	Roth
Formic acid >98%.....	Roth
Glycerine.....	Roth
Glycine p.a.....	Roth
Harris Hematoxylin.....	Roth
<i>n</i> -Hexan 95%.....	Roth
<i>o</i> -Phosphatic acid 85%,.....	Roth
Roti-Block.....	Roth
Roti-Histol.....	Roth
Roti-Load 1 (4x conc.).....	Roth
Rotiphorese Gel 30 (1:37).....	Roth
SDS ultra pure.....	Roth
Temed.....	Roth
Thiourea Ultra Pure.....	Roth
Tris.....	Roth
Tween 20.....	Roth

ApoA1 –sc30089.....	Santa Cruz Biotechnology
ApoE –sc31824.....	Santa Cruz Biotechnology
Hpx –sc49965.....	Santa Cruz Biotechnology
Pon1 –sc21147.....	Santa Cruz Biotechnology
Rbp –sc25850.....	Santa Cruz Biotechnology
Tthy –sc13098.....	Santa Cruz Biotechnology
Ammonium phosphate dibasic.....	Sigma-Aldrich
DL-Dithiothreitol for electrophoresis ≥99%.....	Sigma-Aldrich
Formic acid LC-MS.....	Sigma-Aldrich
Imidazole.....	Sigma-Aldrich
NaOH.....	Sigma-Aldrich
Sodium dodecyl sulphate (SDS).....	Sigma-Aldrich
Succinic acid.....	Sigma-Aldrich
Trifluoroacetic Acid, puriss. p.a., eluent additive for LC-MS, ≥99.0%.....	Sigma-Aldrich
Triton x-100.....	Sigma-Aldrich
Urea for electrophoresis.....	Sigma-Aldrich
Zinc sulfate 2.0M.....	Sigma-Aldrich

Published data

Publications

- **Ritorto M.S.** and Borlak J.

A combined serum and tissue proteomic study applied to a c-Myc transgenic mouse model of hepatocellular carcinoma identified novel disease regulated proteins suitable for diagnosis and therapeutic intervention strategies.

Journal of Proteome Research **2011** (“just accepted”).

- **Ritorto M.S.** and Borlak J.

A simple and reliable protocol for mouse serum proteome profiling studies by use of two-dimensional electrophoresis and MALDI TOF/TOF mass spectrometry

Proteome Science **2008** (doi: 10.1186/1477-5956-6-25).

- **Ritorto M.S.**, Chatterji B. and Borlak J.

Neue Biomarker für Leberkrebs

BioSpektrum **2007** Biotechnika, 13. Jg, 14-15

- Chatterji B., **Ritorto M.S.**, Garaguso I., Belau E., Gazzana G. and Borlak J.

Onkoproteomics von Lungentumoren

BioSpektrum **2006** Biotechnika, 7, 732-735

Posters

- **Ritorto M.S.** and Borlak J.

Low molecular range calibration: preliminary study for accurate mass determination of MALDI spectra at $m/z < 700$

18th International Mass Spectrometry Conference (IMSC2009)

0Bremen, 30.08-04.09.2009

- **Ritorto M.S.** and Borlak J.

Candidate serum biomarkers for HCC identified in a c-Myc transgenic disease model

Proteomic Forum **2009**

Berlin, 29.03-02.04.2009

- **Ritorto M.S.** and Borlak J.

Identification of serum biomarkers by 2-DE and MALDI TOF MS

HUPO Annual World Congress **2008**

Amsterdam, 16.08-20.08.2008

Patent

Borlak J. and **Ritorto M.S.** “Translational research with a c-Myc transgenic

mouse model identifies novel serum and tissue biomarkers of human NASH”

Patent application September 2010

Curriculum Vitae

Personal Data

Last Name, Name	Ritorto, Maria Stella
Date of Birth	27 September 1979
Place of Birth	Rome (IT)
Nationality	Italian
Address	via Caravaggio 45, 00010, Rome (IT)
Mobile	+49-1638101261 +39-3492888180

Education

University	Università degli Studi “La Sapienza” Rome (RM, Italy) Laurea di Dottore in Farmacia (Master degree in Pharmacy) (score: 110/110 <i>cum laude</i>) (experimental thesis)	1998-2004
High School	Liceo Scientifico Statale “G.Peano” Monterotondo (RM, Italy) High-school diploma in scientific science (score: 55/60)	1993-1998

Fellowships

Leonardo Da Vinci Program EU-Program -Noopolis-Onlus & **2005-2006**
Universit  degli Studi "La Sapienza"
& Fraunhofer ITEM
Hannover (Germany)
"Proteomic analysis of mouse sera"

Laboratory assistant Universit  degli Studi "La Sapienza" **2003-2004**
Rome (RM, Italy)
"Methods for quantitative analysis of drugs"

Training courses

HPLC and sample preparation Sigma Aldrich **2010**
Hannover (Germany)

MALDI-MS Bruker Daltonik **2006**
Bremen (Germany)

UPLC seminar Waters **2004**
Rome (Italy)