

Tricarbonylchrom(0)-Komplexe von Phthalimids Derivaten

**Von Der Naturwissenschaftlichen Fakultät
der Gottfried Wilhelm Leibniz Universität Hannover**

zur Erlangung des Grades

Doktor der Naturwissenschaften

Dr. rer. nat.

genehmigte Dissertation

von

M. Sc.

Osama Mahmoud Ali Habib

geboren am 26.04.1973 in Libya

2010

Referent : Prof. Dr. H. Butenschön

Correferent : Prof. Dr. H.Duddeck

Tag der Promotion : 17. 03. 2010

Hierdurch erkläre ich, dass die vorliegende Dissertation selbstständig verfasst und alle benutzten Hilfsmittel sowie eventuell zur Hilfeleistung herangezogene Institutionen vollständig angegeben sind.

Die Dissertation wurde nicht schon als Diplom- oder ähnliche Prüfungsarbeit verwendet.

Hannover, den 01.02.2010

Abstract

Tricarbonyl(phthalimide)chromium(0) complexes were prepared and the reactivity towards different nucleophiles was investigated. The nucleophilic addition of Grignard reagents to tricarbonyl(phthalimide)chromium(0) complexes **72**, **78** and **102** occur from the face opposite to the tricarbonylchromium moiety and lead to *exo*-substituted complexes **147**, **149** and **155** respectively. At low temperature. Tricarbonyl(2-bromoethyl phthalimide)Chromium(0) (**81**) reacted with methyl magnesium chloride at low temperature to give complex **156** with an *endo* OH as the sole product. When this reaction was carried out at room temperature we not only obtained complex **156** but also the tricyclic **157** which resulted from removal of HBr was separated. It was reported that related structures to the tricyclic **157** are biologically active. Complex **78** was reduced to complex **154** by the reaction with sodium borohydride at low temperature. The reaction of complex **149** with methyl iodide in presence of sodium hydride, leads to the formation of the complex **158** with an *endo* methoxy group. Attempts to prepare the stereoisomer of complex **158** by dehydroxylation of complex **149** followed by introduction of methoxy group from the opposite side to Cr(CO)₃ failed, instead we got the dehydrated complex **162** as the main product. Treatment of complex **149** with a mixture of triethylsilane and BF₃-OEt₂ gave complex **169** with an *endo* methyl group with respect to Cr(CO)₃, in addition to dehydrated product **162**. In a trial to differentiate between the two carbonyls, we reacted complexes **78** and **79** with sodium borohydride in presence of 10 mol% oxazaborolidine catalysts **180**, and we obtained the optically active complexes **188** and **189** respectively with 31% ee. In addition we managed to do photochemical ligand exchange for one of the CO groups using Ph₃P, Me₃P and (EtO)₃P. The structures of the reaction products were established with certainty through inspection of spectral data as well as X-ray in some cases.

Key words: Tricarbonylchromium(0). Phthalimide. Chiral Reduction. Photochemical Reaction

Kurzzusammenfassung

Eine Reihe von Tricarbonyl(phthalimide)chrom(0) Komplexen wurde hergestellt, und ihre Reaktivität gegenüber verschiedenen Nucleophilen wurde untersucht. Die nucleophile Addition von Grignard-Reagenzien an die Tricarbonyl(phthalimide) chrom(0) Komplexen **72**, **78** und **102** erfolgt von der dem Tricarbonylchrom entgegengesetzten Seite und führt bei tiefer Temperatur zu den jeweiligen exo-substituierten Komplexen **147**, **149** and **155** bzw. Tricarbonyl(2-Bromethyl Phthalimid)Chrom(0)(**81**) reagiert bei tiefer Temperatur mit Methyl Magnesium Chlorid zum komplex **156** mit endo-ständiger OH Gruppe als einzigem Produkt. Wenn dieser Reaktion bei Raumtemperatur wurde, wurde nicht nur komplex **156**, sondern auch das tricyclische **157** als folge der Abspaltung von HBr erhalten. Dem tricyclische Produkt **157** verwandte Strukturen wurde in der Literatur als biologisch aktiv beschrieben. Komplex **78** wurde durch die Reaktion mit Natriumborhydrid bei tiefer Temperatur zu Komplex **154** reduziert. Die Reaction von Komplex **149** mit Methyljodid in Anwesenheit von Natriumhydrid führt zur Bildung Komplex **158** mit einer endo-ständigen Methoxy Gruppe. Versuche, das Stereoisomer von komplex **158** durch Dehydroxylierung von komplex **149** mit anschliessender Einführung der Methoxy Gruppe von der dem Cr(CO)₃ gegenüberliegenden Seite herzustellen, schlugen fehl. Stattdessen wurde der komplex **162** als Hauptprodukt erhalten. Behandlung von komplex **149** mit einer Mischung von Triethylsilan und BF₃-OEt₂ ergab komplex **169** mit einer bezüglich Cr(CO)₃ endo-ständigen Methyl Gruppe, zusätzlich wurde das dehydrierte produkt **162** erhalten. In einem Versuch, zwischen den beiden Carbonyl Gruppen zu unterscheiden, wurden die Komplexe **78** und **79** mit Natriumborhydrid in Gegenwart von 10 mol% Oxazaborolidin-Katalysator **180** umgesetzt, und die optisch aktiven Komplexe **188** und **189** wurden. mit 31% ee erhalten. Ausserdem gelang photochemischer Ligandenaustausch einer CO-Gruppe durch Ph₃P, Me₃P und (EtO)₃P.

Die Strukturen der Reaktionsprodukte wurden durch spektroskopische Daten sowie in einigen Fällen durch Röntgenstrukturanalyse belegt.

Schlüsselwörter: Tricarbonylchromium (0). Phthalimid. Chiral Reduktion. Photochemische Reaktion

Acknowledgments

“ I do thank ALLAH, for all gifts gave me ”

I would like to express my deepest thanks and gratitude to Prof. Dr. Holger Butenschön Professor of organic chemistry at Hannover University, not only for suggesting this interesting work and providing me with complete freedom during the work, but also for the significant encouragement, unfailing help, interest, patience and wisdom on both the professional and personal level served as a constant source of inspiration.

I wish to record special thanks for the advices and fruitful discussion with Dr Ismail Abdelhamid. My special thanks are extended to all of our group members, Dr. Bianka, Dr. Stefanie, Dr. Nikolai, Dr. Karin, Dr. Ingmar Dr. Tamer, Dipl. Björn, Dipl. Jingxiang, Dipl. Monika, Dipl. Evelyne and Dipl. Georg, who were so cooperative with me, also madam Kandil for her friendly helpful and solving all my problems in Germany.

I would like to thank for all the institute staff members and record special thanks to spectroscopy team.

I would like to express my sincere gratitude to my Egyptian professors, Prof. Dr. A. Mahmoud, Prof. Dr. H. El-Sherif, , Prof. Dr Z. Hozien and Prof. Dr. A. Sarhan for helpful, encouragement and supporting me to get my PhD from advanced country like Germany.

Finally, I would like to thank the Egyptian government (Assiut University) for providing continuous funding during this study.

For MyParents,

My wife

And My children

Mahmoud, Youssef and Sara

ABBREVIATIONS

Å	Angstrom(s)
aq.	Aqueous
APT	Attached Proton Test
Ar	Aryl
ATR	Attenuated Total Reflection
Bn	Benzyl
br	Broad (spectral)
Bu	Butyl
<i>t</i> -Bu	<i>tert</i> -Butyl
°C	Degrees Celsius
calcd	Calculated
cat.	Catalyst
cm ⁻¹	Wavenumber(s)
¹³ C NMR	¹³ C Nuclear Magnetic Resonance
δ	Chemical Shift (in parts per million downfield from tetramethylsilane)
d	Day(s)
d	Doublet (spectral)
<i>dr</i>	Diastereomeric Ratio

<i>de</i>	Diastereomeric Excess
<i>decomp.</i>	Decomposition
DEE	Diethyl Ether
DEPT	Distortionless Enhancement by Polarization Transfer
DCM	Dichlormethan
DME	Dimethoxymethan
<i>ee</i>	Enantiomeric Excess
equiv.	Equivalent(s)
Et	Ethyl
g	Gram
GP	General procedure
h	hour(s)
¹ H NMR	¹ H Nuclear Magnetic Resonance
HPLC	High-performance Liquid Chromatography
HRMS	High-resolution Mass Spectrometry
HMQC	Heteronuclear Multiple Quantum Coherence
HMBC	Heteronuclear Multiple Bond Correlation
Hz	Hertz
IR	Infrared
<i>J</i>	Coupling Constant in NMR Spectrometry
L	Ligand

m	Multiplet (spectral)
m	Medium (IR spectra)
M	Molar (moles per liter)
M ⁺	Parent Molecular Cation (in mass spectrometry)
Me	Methyl
MHz	Megahertz
mL	Milliliter(s)
min	Minute(s)
mmol	Millimol
MOMCl	Methoxyethoxymethyl chloride
<i>m.p.</i>	Melting Point
MS	Mass Spectrometry
MTPA	α -Methoxy- α -(trifluoromethyl)- phenylacetic acid
MTPA-Cl	α -methoxy- α -(trifluoromethyl)phenylacetate chloride
<i>m / z</i>	Mass-to-charge Ratio (in mass spectrometry)
NMR	Nuclear Magnetic Resonance
Nu	Nucleophile
PE	Petroleum Ether
Ph	Phenyl
ppm	Part(s) per Million
q	Quartet (spectral)

<i>rac</i>	Racemic
s	Singlet (spectral)
s	Sharp (IR spectra)
TBME	<i>tert</i> -Butylmethyl Ether
THF	Tetrahydrofuran
t	Triplet (spectral)
TLC.	Thin-layer Chromatography
w	weak (IR spectra)

Table of Contents

A	Introduction	1
1.1	Introduction	1
1.2	History	1
1.3	General Reactivity of (η^6 -Arene)Cr(CO) ₃ Complexes	2
1.4	Synthesis of arene tricarbonyl complexes	5
1.4.1	Direct complexation by hexacarbonylchromium (4) and its derivatives 5-8	5
1.4.2	Complexation via arene exchange	7
1.4.3	Synthesis through intramolecular [3+2+1] benzannulation of the Fischer carbene complexes	11
1.5	Importance of phthalimide derivatives	12
B	Results and Discussion	17
1	Synthesis of tricarbonyl <i>N</i> -substituted phthalimide chromium (0) complexes	17
1.1	Introduction	17
1.2	Synthesis of tricarbonyl phthalimide chromium (0) (72)	18
1.3	Synthesis of tricarbonyl (<i>N</i> -methyl, ethyl, vinyl, 2-bromoethyl) phthalimide chromium (0) (78-81)	19
1.4	Synthesis of tricarbonyl (<i>N</i> -phenyl phthalimide) chromium (0) (101), (102)	23
1.5	Proposed fragmentation pattern of tricarbonyl <i>N</i> -substituted phthalimide chromium (0) 72 , 78-81 and 101	23
2	Photochemical substitution reaction of tricarbonyl <i>N</i> -substituted phthalimide chromium (0) complexes	33
2.1	Introduction	33
2.2	Synthesis of [Dicarbonyl (η^6 - <i>N</i> -substitutedphthalimide)triphenylphosphine] chromium(0) 115-117	35

2.3	Synthesis of [Dicarbonyl (η^6 - <i>N</i> -methyl phthalimide)trimethylphosphine, - triethylphosphite] chromium(0) 118 and 119	41
3	Nucleophilic reactions of tricarbonyl <i>N</i> -substituted phthalimide chromium (0) complexes	43
3.1	Introduction	43
3.2	Nucleophilic addition of methyl lithium to tricarbonyl (phthalimide) chromium(0) (72)	48
3.3	Nucleophilic addition of methyl magnesium chloride to tricarbonyl (<i>N</i> -methyl phthalimide) chromium(0) (78).	50
3.4	Reduction of tricarbonyl (<i>N</i> -methyl phthalimide) chromium (0) (78)	51
3.5	Nucleophilic Addition of methyl magnesium chloride to tricarbonyl (<i>N</i> -phenyl η^6 phthalimide) Chromium(0) (102)	52
3.6	Nucleophilic Addition of methyl magnesium chloride to tricarbonyl (<i>N</i> -2-bromo ethyl phthalimide) Chromium(0) (81)	53
3.7	Methylation of tricarbonyl(3-hydroxy-2,3-dimethyl-2,3-dihydro-isoindol-1-one) chromium(0) (149)	56
3.8	Dehydration of tricarbonyl(3-hydroxy-2,3-dimethyl-2,3-dihydro-isoindol-1-one) chromium(0) (149)	57
3.9	Reduction of tricarbonyl(3-hydroxy-2,3-dimethyl-2,3-dihydro-isoindol-1-one) chromium(0) (149)	61
4	Desymmetrisation of tricarbonyl <i>N</i> -substituted phthalimide chromium (0) complexes	63
4.1	Asymmetric olefination by using a chiral phosphonoacetate	63
4.2	Asymmetric reduction by using a chiral oxazaborolidine catalyst	65
4.3	Asymmetric reduction tricarbonyl <i>N</i> -substituted phthalimide chromium (0) by using chiral oxazaborolidine catalyst	67
4.4	Determination of Enantiomeric Excess of (+)-93 Using Mosher's reagent	70
4.5	Synthesis of (R)-MTPA Ester of tricarbonyl(3-hydroxy-2-methyl-2,3-dihydro-isoindol-1-one) chromium(0) (189)	72
C	Summary	73
D	Experimental	81
1.	General Remark	81
2	Synthesis of <i>N</i> -substituted-Phthalimide tricarbonylchromium(0) Complexes	83

2.1	General procedure for the synthesis of <i>N</i> -substituted phthalimide tricarbonyl chromium(0) complexes (GP1):	83
2.1.1	Tricarbonyl(phthalimide)chromium(0)(72)	83
2.1.2	Tricarbonyl(<i>N</i> -methylphthalimide)chromium(0) (78)	84
2.1.3	Tricarbonyl(<i>N</i> -ethylphthalimide)chromium(0) (79)	85
2.1.4	Tricarbonyl(<i>N</i> -vinylphthalimide)chromium(0) (80)	86
2.1.5	Tricarbonyl(<i>N</i> -2-bromoethylphthalimide)chromium(0) (81)	87
2.1.6	Tricarbonyl (potassiumphthalimide)chromium(0) (82)	88
2.1.7	Tricarbonyl(<i>N</i> -phenylphthalimide)chromium(0) (101 and 102)	89
3	General procedure for the photolysis of <i>N</i> -substituted phthalimide tricarbonyl chromium complexes 115-120 (GP2)	91
3.1	Dicarbonyl(phthalimide)triphenylphosphine chromium(0) (115)	91
3.2	Dicarbonyl(η^6 - <i>N</i> -methylphthalimide)triphenylphosphine chromium(0) (116)	92
3.3	Dicarbonyl[(η^6 - <i>N</i> -vinylphthalimide)triphenylphosphine chromium(0) (117)	93
3.4	Dicarbonyl(η^6 - <i>N</i> -methylphthalimide)trimethylphosphine chromium(0) (118)	94
3.5	Dicarbonyl(η^6 - <i>N</i> -methylphthalimide)triethylphosphite chromium(0) (119)	95
4	General Procedure for the nucleophilic addition to <i>N</i> -substituted phthalimide tricarbonylchromium (GP3)	96
4.1	Tricarbonyl(3-hydroxy-1-methyl-2,3-dihydro-isoindol-1-one)chromium(0) (147)	96
4.2	Tricarbonyl(3-hydroxy-2,3-dimethyl-2,3-dihydro-isoindol-1-one)chromium(0) (149)	97
4.3	Tricarbonyl (3-hydroxy-2-methyl-2,3-dihydroisoindol-1-one)chromium(0) (154)	98
4.4	Tricarbonyl(3-hydroxy-3-methyl-2-phenyl-2,3-dihydroisoindol-1-one)chromium (0) (155)	99
4.5	Tricarbonyl[2-(2-bromo-ethyl)-3-hydroxy-3-methyl-2,3-dihydro-isoindol-1-one] chromium(0) (156)	100
4.6	Tricarbonyl(9b-Methyl-2,3-dihydro-9bH-oxazolo[2,3-a]isoindol-5-one) chromium (0) (157)	101
4.7	Synthesis of tricarbonyl(2,3-dimethyl-3-methoxy-2,3-dihydro-isoindol-1-one) chromium(0) (158)	102
4.8	Synthesis of tricarbonyl (2-methyl-3-methylene-2,3-dihydro-isoindol-1-one) chromium(0) (162)	103
4.9	Tricarbonyl(2,3-dimethyl-2,3-dihydro-isoindol-1-one)Chromium(0) (169)	104

4.10	Optically active tricarbonyl (3-hydroxy-2-methyl-2,3-dihydroisindol-1-one)	105
	chromium(0) (188)	
4.11	Optically active tricarbonyl (3-hydroxy-2-ethyl-2,3-dihydroisindol-1-one)	106
	chromium(0) (189)	
E	References	107

1.1 Introduction^[1]

The unique bonding characteristics of aromatics, the stability of the benzene ring system, and the varied and often complex chemistry of arenes and heteroarenes have fascinated chemists for close to two centuries. Benzene rings are omnipresent in organic chemistry and they find important applications for example in the pharma, agrochemical, and polymer fields. New applications of aromatics include sectors such as functional materials and molecular machines. Electrophilic aromatic substitution as a route to differentially substituted products is well established. The often forcing conditions, the incompatibility of this process with acid-sensitive functional groups, and the need for mild and selective syntheses have been the driving forces in the search for new methods of synthesis. A large range of methods has been developed over the past 20 years: they include the trimerization of alkynes,^[2,3] the directed ortho-metallation,^[4,5] the benzannellation via metal carbenes,^[6] and transition metal-catalyzed carbon-carbon and carbon-heteroatom bond formation.^[7] Aromatic C-H activation,^[8] while still in its beginning stages, is another area of promise. This thesis focuses on transition metal arene π -complexes. Following the discovery of ferrocene and the determination of its sandwich structure, it did not take long before a large number of sandwich and half-sandwich complexes of benzene and its derivatives saw the light of day and became the subject of intense study. These events and the parallel development of transition metal catalyzed reactions were decisive in the vast interest that arose in the study and chemistry of compounds containing metal carbon bonds. Thus organometallics have become a major component in the chemistry field, a trend that has continued unabated to this day. Organometallics have strongly enriched the fields of homogeneous catalysis, coordination chemistry, and synthetic organic chemistry. Metal-arene π -complexes show a rich and varied chemistry. The metal adds a third dimension to the planar aromatic compounds and distinguishes the two enantiotopic faces of an arene with different *ortho* or *meta*-substituents. Therefore, coordination of a metal to an arene not only alters the reactivity of ring-carbon atoms and substituents as well as groups in benzylic positions but, in addition, also allows reactions with high stereoselectivities to be carried out.

1.2 History

(Benzene)tricarbonylchromium (**1**) was first obtained by Fischer and Öfele in 1957 from hexacarbonylchromium and dibenzenechromium in benzene in a sealed system at 220 °C.^[9] Then Nicholls and Whiting discovered a simpler and more general method for preparing

compounds of this type, which involves heating of hexacarbonylchromium under reflux in an excess of the aromatic compound or with a molar quantity in an inert solvent.^[10] Shortly, Natta and his co-workers also described the direct preparation of several of these compounds, but used a pressurised system (with intermittent release of carbon monoxide) and higher temperatures (200-235 °C).^[11] The work of Fischer shows that equilibria are involved in these reactions an excess of carbon monoxide converts the dibenzenechromium complex into the hexacarbonyl, and therefore it is advantageous in principle, as well as much easier in practice, to employ an open system. The free escape of carbon monoxide then driving the reaction to completion. Also Fischer gave the molecular shape and bonding of tricarbonylbenzenechromium (Fig. 1).^[12]

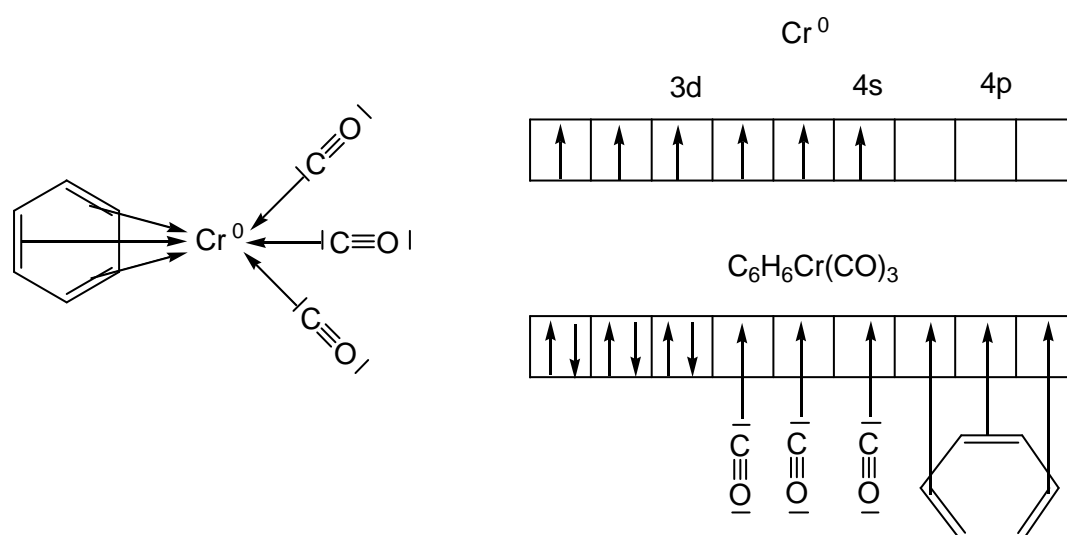

Figure 1. The molecular shape and molecular bonding of tricarbonyl (benzene) chromium (1).

1.3 General Reactivity of (η^6 -Arene)Cr(CO)₃ Complexes

(η^6 -Arene)tricarbonylchromium complexes have received much attention as key building blocks for organic synthesis.^[13] The reactivity changes that arise upon the complexation of an arene to the tricarbonylchromium(0) unit allow a variety of transformations that can otherwise not be achieved by free arenes.^[14] The ease of preparation and handling and the ease with which the fragment can be readily removed at the end of a synthetic sequence complement the characteristic versatility of (arene)Cr(CO)₃ complexes.

The Cr(CO)₃ group modifies the chemical properties of the arene ring in several distinct characteristic fashions (Fig. 2). Compared to the uncomplexed arene the η^6 -coordinated arene ring is more susceptible to nucleophilic attack due to the electron withdrawing properties of the Cr(CO)₃ unit. The kinetic acidity of the hydrogen atoms at the aromatic ring is increased. Benzylic anions are readily formed by deprotonation, but despite the predominantly electrophilic character of the Cr(CO)₃ unit, benzylic carbocations are also readily stabilized. In addition to this, the Cr(CO)₃ moiety has found widespread use as a “stereodirecting” group in reactions at side chains attached to the arene ring by sterically hindering the reagent approach to the same face of the arene.

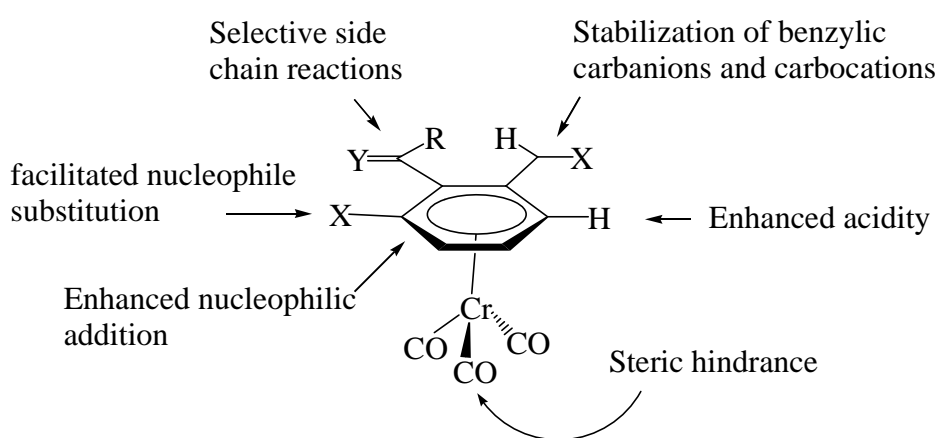

Figure 2. Changes in arene reactivity after complexation with tricarbonyl chromium^[15]

Another stereochemical feature of (arene)tricarbonylchromium complexes is the transformation of prochiral *ortho* or *meta* unsymmetrically disubstituted arene ligands into planer chiral complexes. The only symmetry element present in a unsymmetrically 1,2- or 1,3-disubstituted achiral arene is a plane of symmetry, which lies in the plane of the arene ring and can be eliminated through the complexation at a Cr(CO)₃ moiety. As a consequence complex **2** cannot be superimposed on its mirror image *ent-2*; complexes such as **2** and *ent-2* are planar chiral. (Fig. 3)

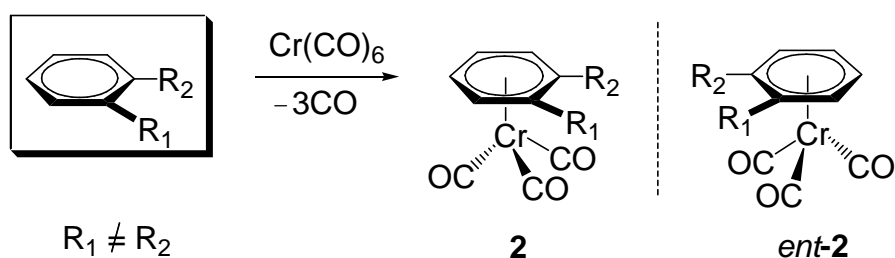

Figure 3. Planar chirality of arene tricarbonylchromium complex

The stereochemical assignment of such complexes in this report is in accord with the Cahn-Ingold-Prelog (CIP) rules^[16] and will be explained by means of complex **3**. All the carbon atoms of the complexed arene ring are considered to be pseudo-tetrahedral with the chromium atom occupying the fourth corner of the tetrahedron. The priorities are assigned according to the CIP rules. As illustrated that the tetrahedron is rotated so that the position with the lowest priority is furthest from the observer; in the case illustrated, this results in a clockwise screw and therefore a (*1R*) centre. In most cases it is sufficient to classify only the stereogenic centre with the highest priority substituent. To further specify the element of planar chirality, a (*p*) is put in front, complex **3** is described as (*1pR*)-**3** (Fig. 4).

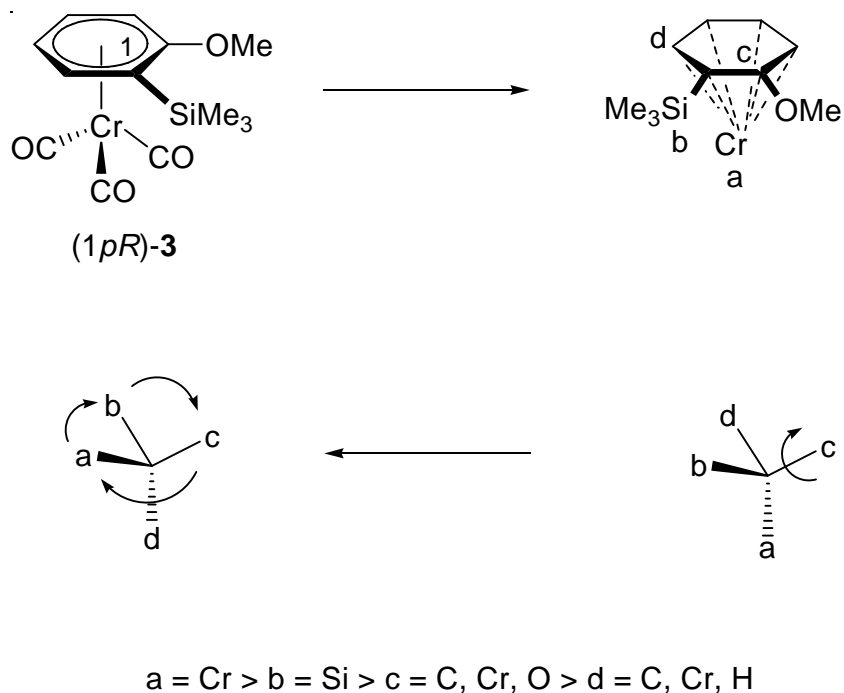

Figure 4. Stereochemical assignment in (arene)tricarbonylchromium complex

1.4 Synthesis of arene tricarbonyl complexes

The arene tricarbonyl complexes of chromium are yellow to red, often crystalline compounds that are stable to air in the solid state and can be stored for longer periods of time provided they are kept away from light. In solution they are moderately air sensitive.

1.4.1 Direct complexation by hexacarbonylchromium (4) and its derivatives 5-8.

The preferred method for the synthesis of (arene)Cr(CO)₃ complexes is thermolysis of Cr(CO)₆ in an inert atmosphere (nitrogen or argon) in the presence of an excess of the arene in a high-boiling solvent. This can be the arene itself or a variety of solvent mixtures, the most frequently adopted procedure is a mixture of the arene, dibutyl ether / THF (10:1),^[17] the polar ether and ester additives (or solvents) promote carbonyl dissociation, stabilize intermediates, and the vigorous reflux of lower boiling additives washes sublimed Cr(CO)₆ back into the reaction mixture. This procedure is suited for the preparation of a wide range of complexes, often in high yields (80-95%) with reaction times typically in the 1-4 day range. By this method our group has synthesized many complexes such as those of the acetals of benzocyclobutenone **9**,^[18] benzocyclobutendione **10**,^[19] 1,3-indandione **11**,^[20] 1,2-indandione **12**,^[21] 1,2,3-indantrione **13** and **14**,^[20] phenol derivatives **15**^[22] and *N*-methyl-3,3-dimethoxyisatin **16**^[23] (Fig. 5).

Milder complexation conditions and shorter reaction times are possible with suitable Cr(CO)₃L₃ (L = CH₃CN, Py, NH₃) precursors **5-8** (Fig. 6), the advantages of lower temperatures for arene complexation are higher compatibility with arenes bearing functional groups and higher chemo and diastereoselectivities.^[24] Cr(CO)₃(NH₃)₃ **5** is best prepared by treating Cr(CO)₆ with KOH in EtOH, followed by addition of aqueous ammonia,^[25] while Cr(MeCN)₃(CO)₃ **6** and Cr(CO)₃Py₃ **7** are prepared by heating Cr(CO)₆ at reflux in the appropriate solvent. Reagent **5** was used in the preparation of complexes **17** (85 %),^[25] **18** (70 %)^[26] and **19** (83 %),^[27] while reagent **6** was used in the preparation of complexes **20** (35 %),^[28] **21** (74 %)^[29] and **22** (72 %),^[30] finally reagent **7** was used in the preparation of complex **23** (70 %)^[31] (Fig. 7).

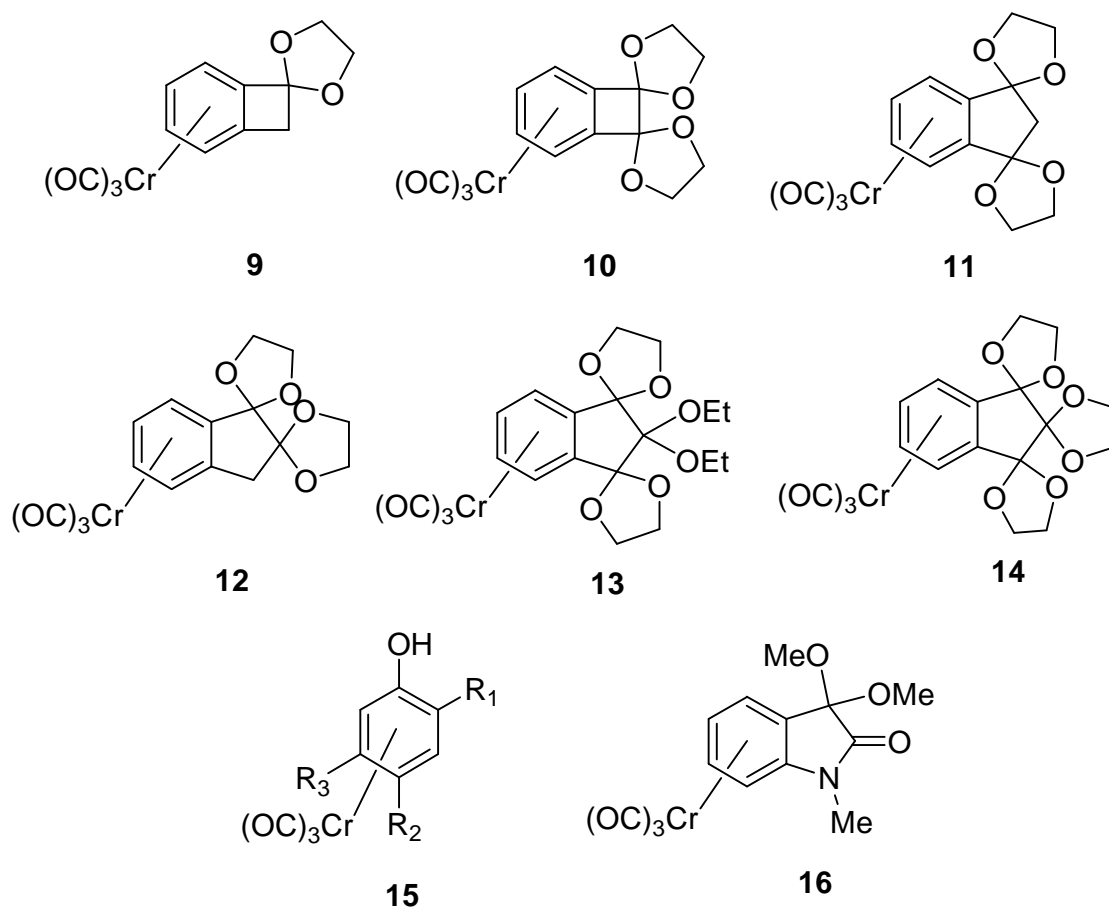

Figure 5. Complexes 9-16

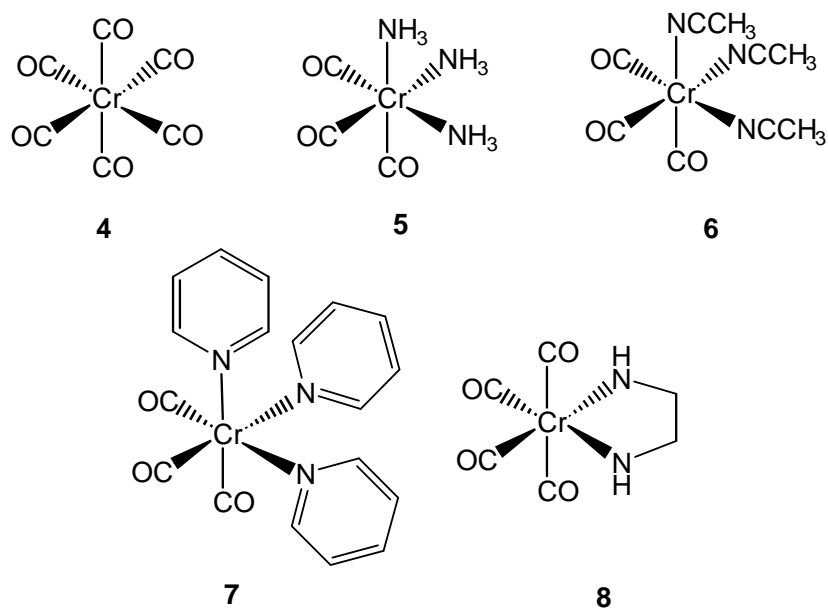
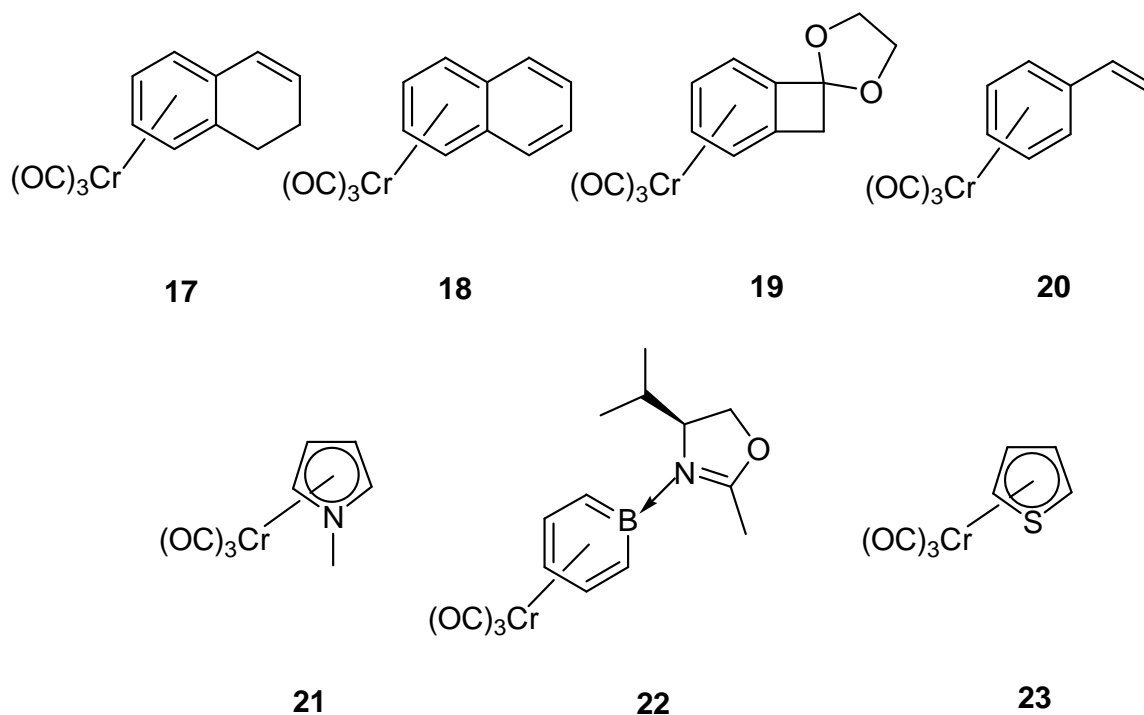
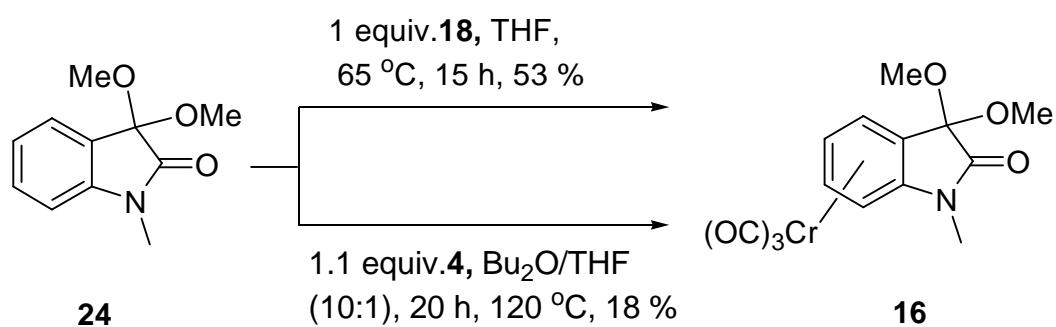

Figure 6. Complexation reagents

Figure 7. Complexes **17-23**

1.4.2 Complexation via arene exchange

Complexation can also be carried out by arene exchange in (naphthalene)Cr(CO)₃ (Kündig-Reagent) **9**.^[32] This method has found widespread use due to highly facile arene exchange and the ease with which this complex can be handled.^[32-39] Also in some cases it gives higher yields than the direct complexation with Cr(CO)₆, for example direct complexation of **24** using hexacarbonylchromium gives only 18 % yield of **16**, while using (naphthalene)Cr(CO)₃ (**18**) increase the yield to 53 % (Scheme 1).^[23]

Scheme 1. Complexation reactions of *N*-methyl-3,3-dimethoxyisatin **24**

Arene exchange in the (arene)Cr(CO)₃ series has been studied for 40 years.^[40,41] Typically, high activation barriers are observed, and side reactions are often faster and irreversible. Arene exchange reactions are typically run at 140-180 °C in the presence of a large excess of the incoming arene. Conversions are good when the incoming arene is more electron rich than the leaving arene, as in the case of (benzene)Cr(CO)₃ (**1**) and aniline to give the aniline complex **25** (scheme 2).^[42]

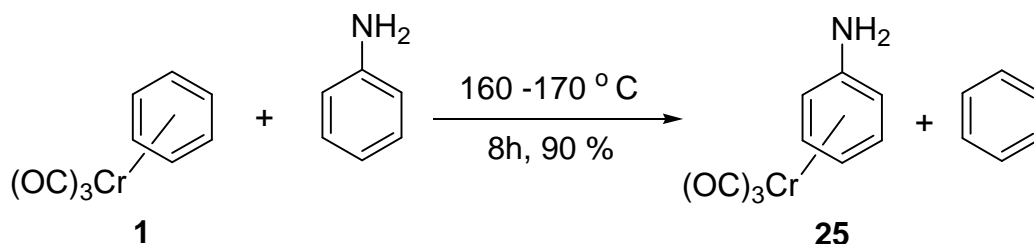

Scheme 2. Complexation of aniline *via* arene exchange

The first proposed mechanism involved complete dissociation of the Cr(CO)₃ unit followed by an S_N2-like attack on the arene ligand of another (arene)Cr(CO)₃ complex; the central observation favoring this picture was the second-order rate dependence on the (arene)Cr(CO)₃ concentration.^[40, 41] Additional experiments were incompatible with this mechanism, and it was soon replaced by a stepwise “unzipping” mechanism (scheme 3).^[43-45] In the first (rate-determining) step, one of the arene double bonds detaches from **26** to generate a coordinatively unsaturated η^4 intermediate, **27**. In a subsequent fast step, the incoming arene coordinates in η^2 fashion **28**. The leaving arene further detaches, while the incoming arene fills the liberated coordination site to give first the η^4 , η^2 intermediate **29**, and finally the η^6 product **30**. Details of the mechanism in Scheme 3 are still unclear since intermediates **27**, **28**, and **29** have not been observed spectroscopically. On the basis of Hückel molecular orbital (MO) calculations, direct attack of an arene on the chromium complex is improbable due to high electron density on the chromium center.^[46] It was therefore proposed that predissociation of the arene is followed by attack on the resulting unsaturated η^4 species **27**. An alternative mechanism begins with a complete dissociation of the (arene)Cr(CO)₃ complex to give intermediate **31** in Scheme 4 followed by fast coordination of the incoming arene. This was probed with a “three-phase test”, where a bead-to-bead migration of the Cr(CO)₃ unit was detected at 170 °C in the presence of polar additives such as cyclohexanone or THF but not in their absence (cyclohexane solvent).^[43]

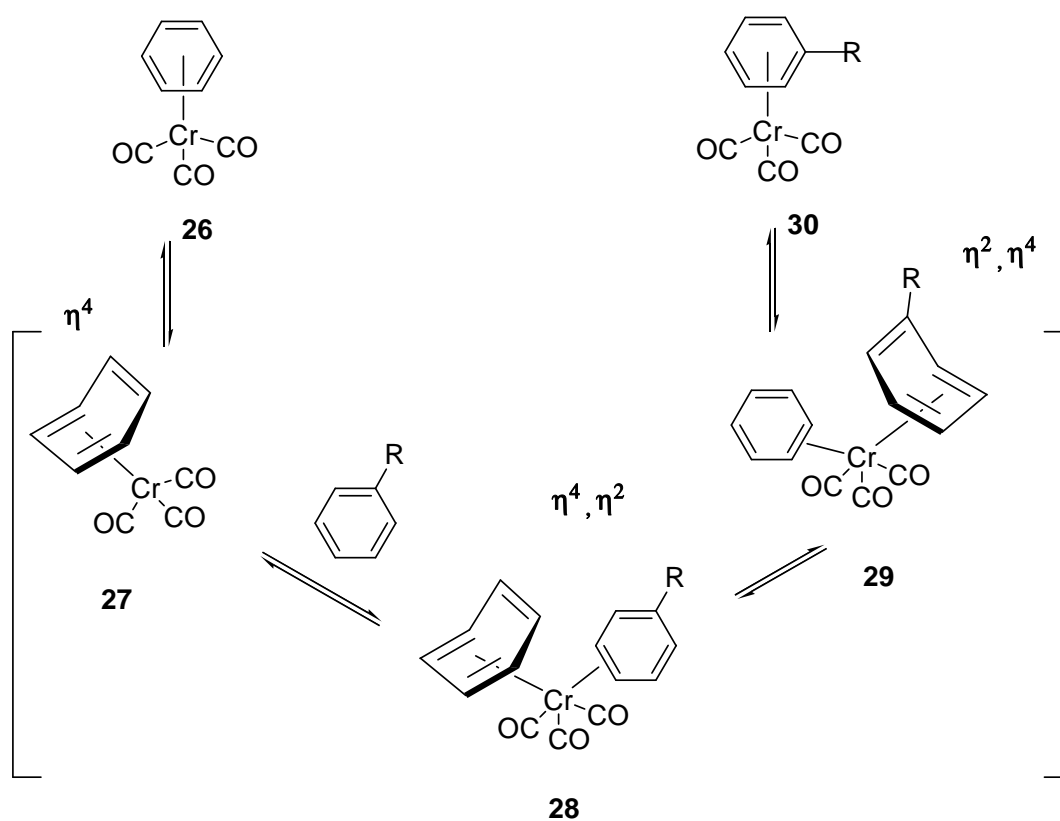

Scheme 3. Associative mechanism of arene ligand exchange

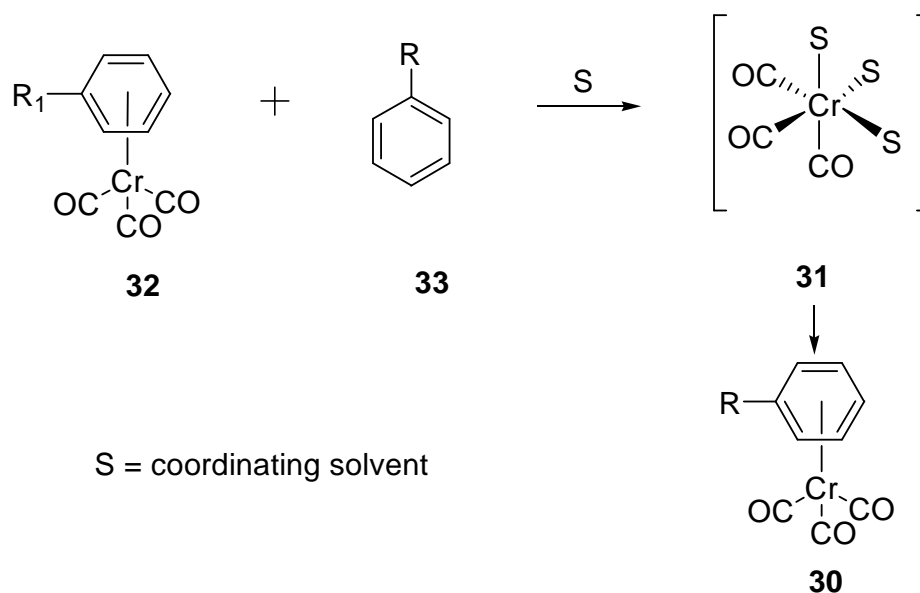

Scheme 4. Three-phase test for exchange

Addition of hexasubstituted (arene)Cr(CO)₃ complex **34** (scheme 5) catalyzes arene exchange of another (arene)Cr(CO)₃ complex (**35**) without undergoing exchange itself.^[44,45] This effect

was attributed to the coordination of the carbonyl ligand in **36** to lower the barrier to the η^6 to η^4 conversion of the arene ligand. Other donor molecules such as THF and cyclohexanone also catalyze arene exchange.^[47,48]

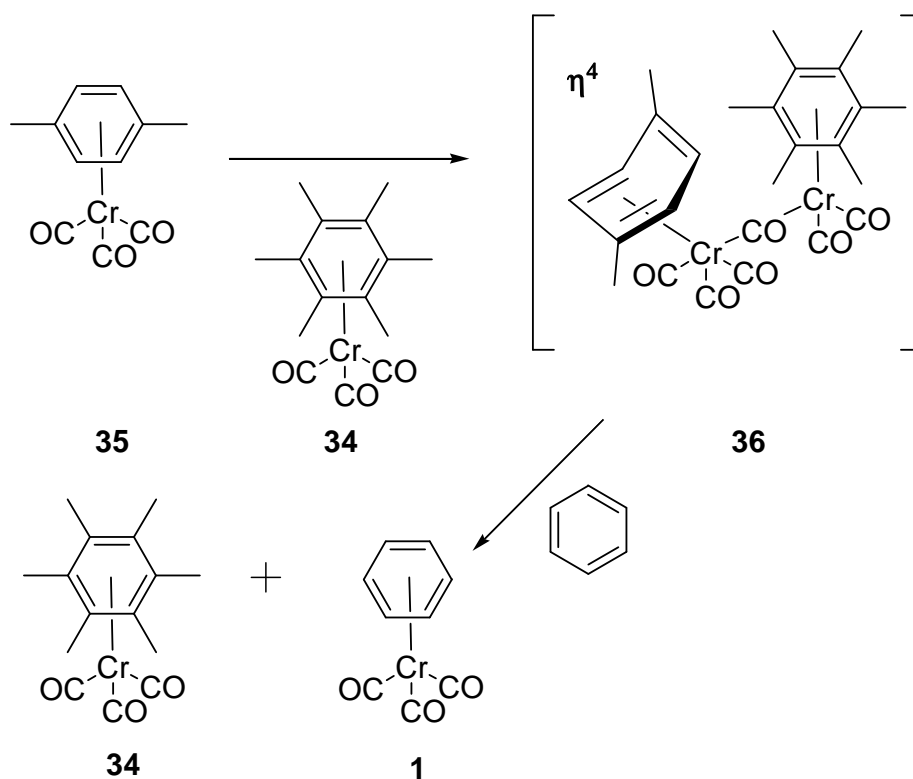

Scheme 5. Arene exchange assisted by interaction with a second arene complex

Structure-reactivity relationship in arene exchange has been investigated by study of the equilibrium constants for both the forward and reverse arene exchange reactions,^[43] the stability order presented in Fig. 6 was determined. This order is consistent with the arene-chromium bond energies measured by microcalorimetry.^[49-51] An interesting point is the absence of a destabilizing steric effect of the methyl groups on the thermodynamic stability of the (alkylbenzene)Cr(CO)₃ complexes and the stability order parallels the number of the methyl groups and is fairly independent of their relative position on the aromatic ring (Fig 8).

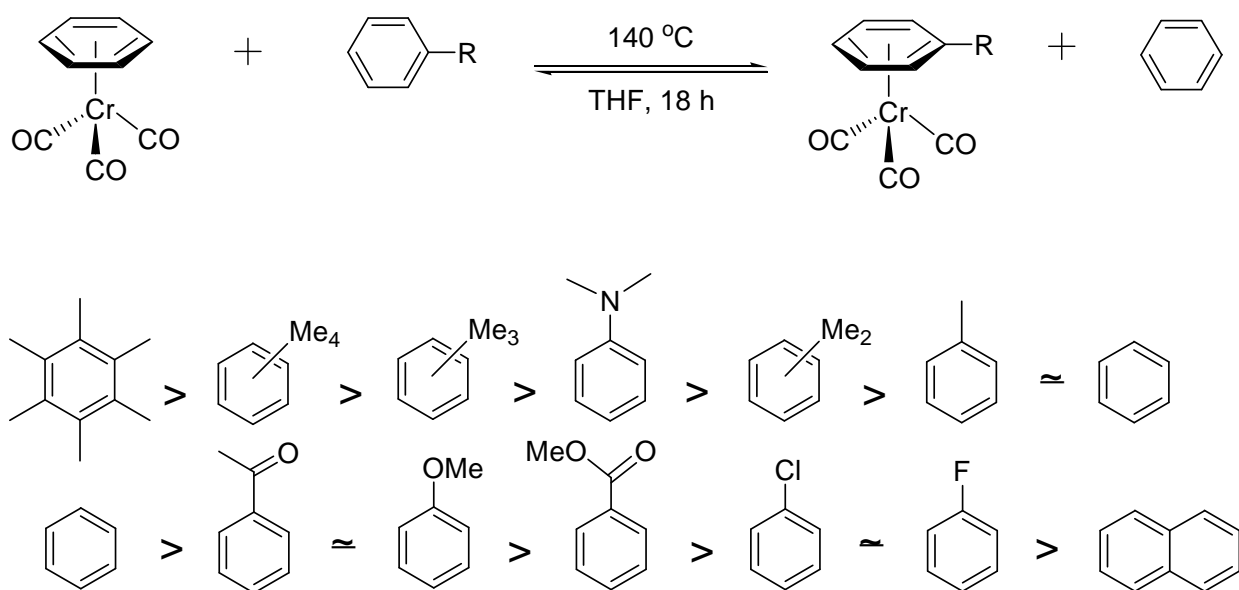
Figure 8. Relative stability of (arene)Cr(CO)₃ complexes.

1.4.3 Synthesis through intramolecular [3+2+1] benzannulation of the Fischer carbene complexes.

Carbene complexes contain metal-stabilized carbenes.^[52] These compounds can be divided into two classes: the Fischer-type^[53] and the Schrock-type.^[54] Starting with Fischer-type compound such as **37**, which contains an unsaturated carbene ligand, the addition of an alkyne to the free coordination site leads to a facial alkyne-carbene-carbonyl complex **38**. This reactive intermediate has not yet been isolated. It undergoes rather a clean cycloaddition reaction to give an aromatic six-membered ring which is π -bonded to the metal (Scheme 6).^[55]

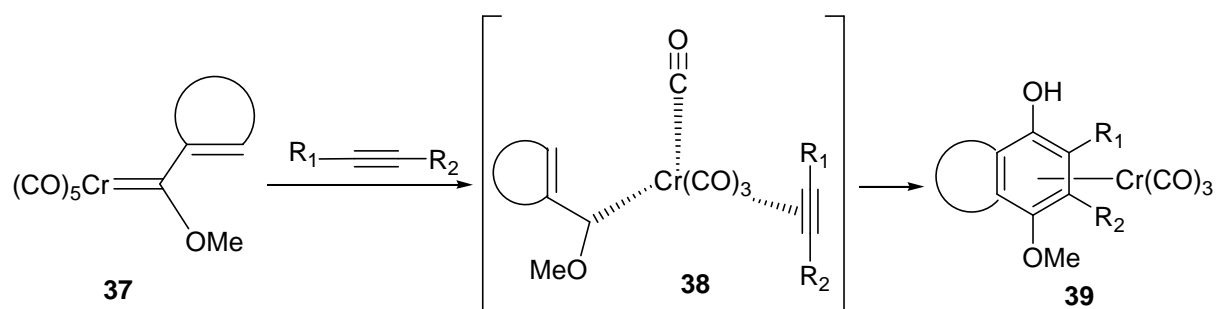

Scheme 6. Cycloaddition of alkyne, carbene, and carbonyl ligands

The alkyne is incorporated into the 2,3-position of the hydroquinone derivative, while the C-4 – C-6 ring positions come from the carbene ligand, whereas C-1 is contributed by the carbonyl ligand. The cycloaddition takes place in donor solvents (e.g., ethers) under mild conditions (40- 60°C); the yields are usually 60-90%. The formation of the arene complex **39**

is not limited to vinyl-^[56] and phenylcarbene substituents.^[57-59] Carbocycles, heterocycles, and polycyclic arene ligands.^[60] can also serve as carbene ligands for the synthesis of complexes with benzoannulated arenes (Scheme 7).

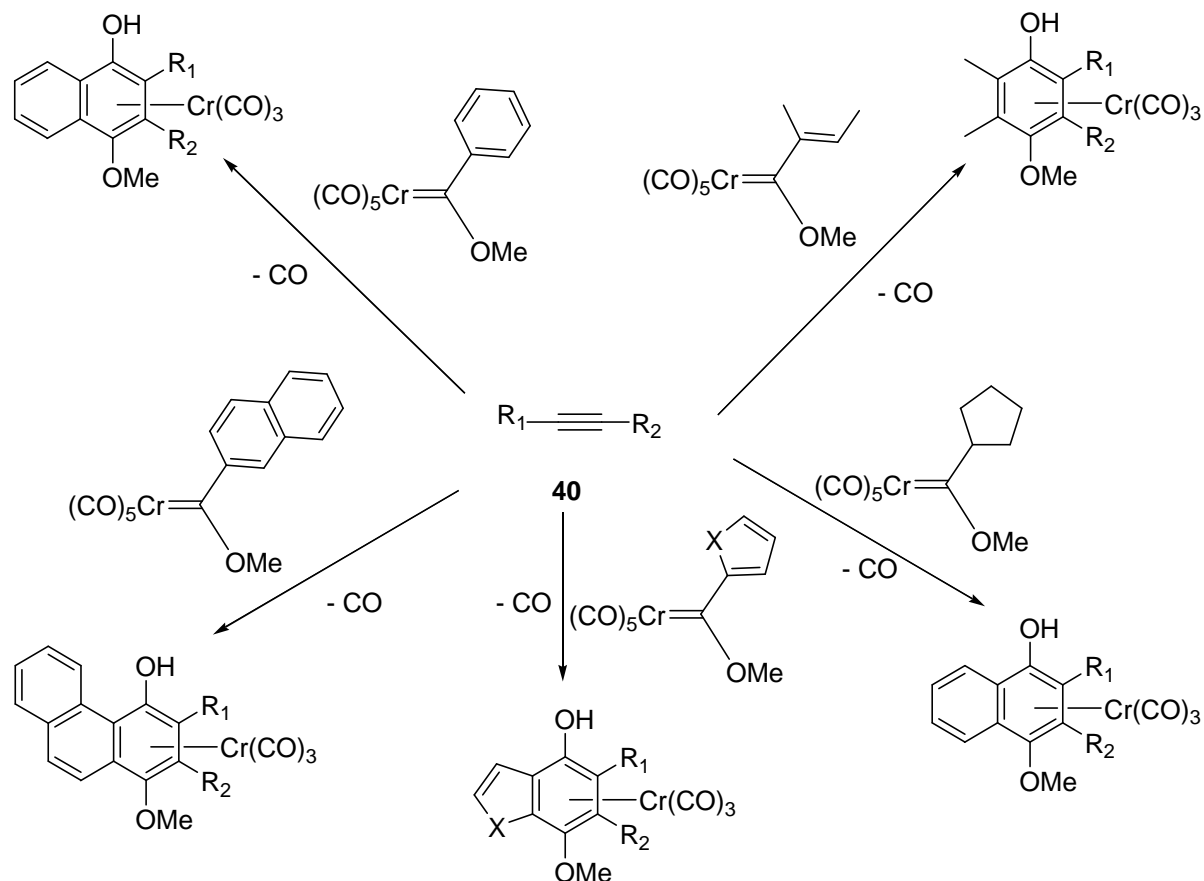

Scheme 7. Benzoannulation of carbene ligands with alkyne **40**.

1.5 Importance of phthalimide derivatives

N-Substituted phthalimides (**41**) and the class of isoindolinones (**42**) and 3-substituted 2,3-dihydroisoindolinones (**43**) called phthalimidines are of importance in organic chemistry, particularly in the field of medicinal applications.^[61-67]

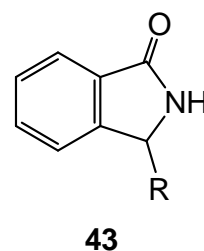
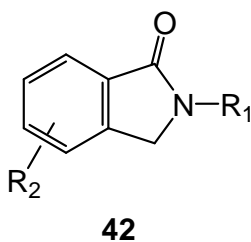
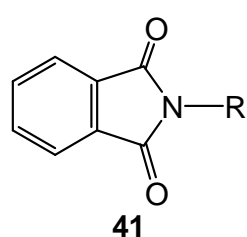

The considerable interest in these heterobicyclic compounds stems mainly from their diverse biological activities^[68-71] and their availability as reactive intermediates in synthesis.^[72,73] A wide range of naturally occurring and bioactive substances are linked to the potential compounds comprising the phthalimidine unit as synthetic building blocks.^[74-80] For example; substituted-*N*-phenyl phthalimides (**44**, anticonvulsant and neurotoxic agent),^[62] (**44**, α -Glucosidase inhibitor),^[81] *N*-phenyl phthalimide sulfonamides (**45**, anti-inflammatory agent),^[81] indoprofen (**46**, anti-inflammatory agent),^[82] deoxythalidomide (**47**, reducer of tumor necrosis factor production),^[83] batracyclin (**48**, neoplasm inhibitor),^[84] lennoxamine^[85] (**49**, isolated from various barberries species), pazinaclone (**50** anxiolytic drug candidate)^[86] 3-piperazinyloethyl isoindolinone derivative (**51** dopamine D4 receptor antagonist).^[87] In addition, (*R*)- and (*S*)-3-methyl-isoindolin-1-ones have been shown to be valuable chiral auxiliaries.^[88]

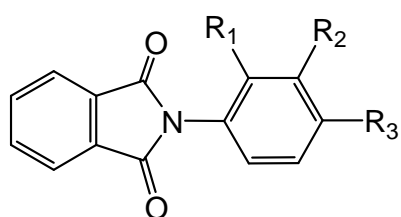

$R_1, R_2, R_3 = \text{H, CH}_3, \text{NO}_2, \text{NH}_2, \text{halogen}$

44

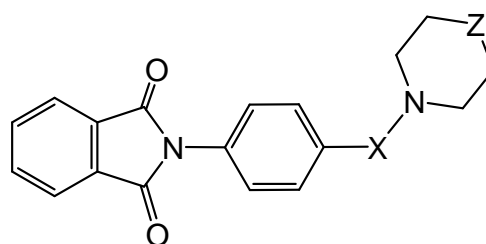

$X = \text{CO, SO}_2$
 $Z = \text{O, S, NH, NPh, NCH}_3$

45

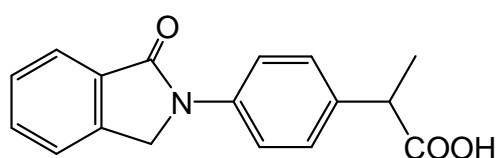

46

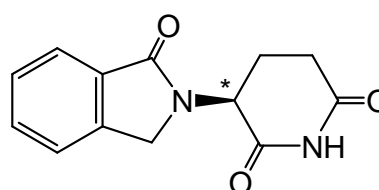

(S)-47

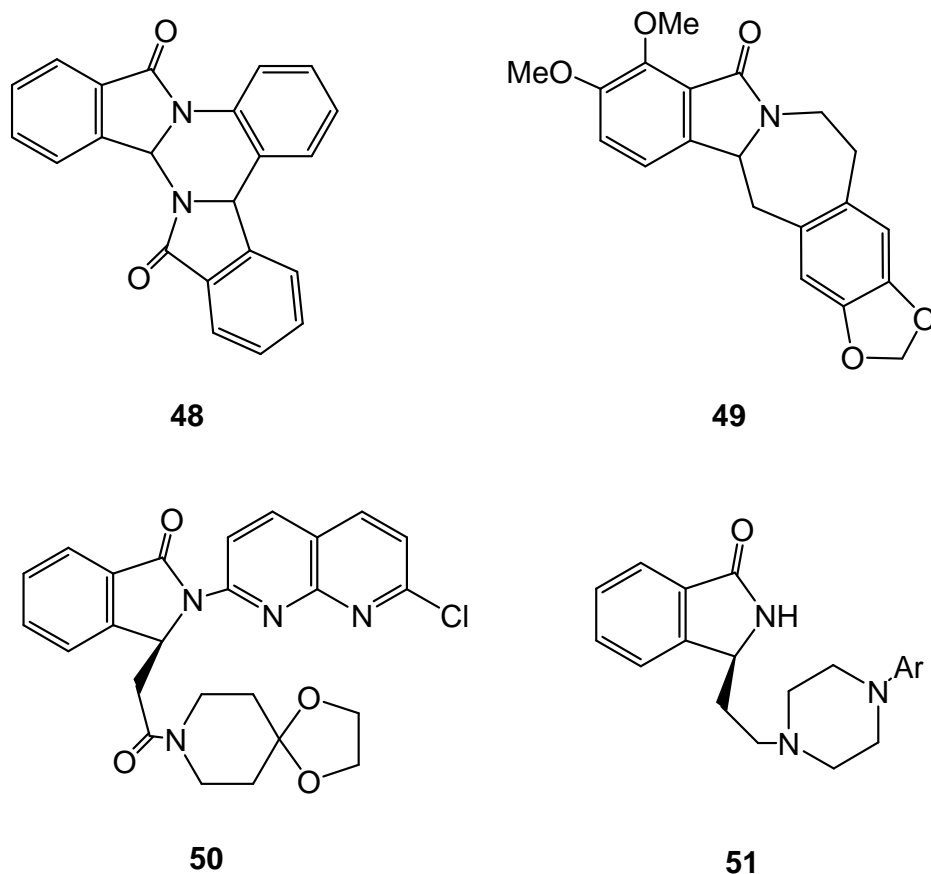
Figure 9. Phthalimide derived compounds **44-51**

Accordingly, many efforts have been devoted to the asymmetric synthesis of the simple chiral 3-substituted isoindolinones **43**^[89-91]. Among the number of synthetic routes to 3-substituted isoindolin-1-ones (**43**), the straightforward and efficient asymmetric synthetic approaches are based on the nucleophilic addition of an organometallic reagent to a phthalimide precursor attached to a chiral auxiliary at the nitrogen atom.^[90]

It is well established that planar-chiral arene tricarbonylchromium complexes represent highly valuable building blocks for the diastereo- and enantioselective synthesis of complex compounds. In principle, the powerful electron withdrawing effect of the $\text{Cr}(\text{CO})_3$ group might dramatically facilitate the nucleophilic attack at the amide group of the phthalimide.

Moreover, it is possible to induce stereoselectivity of chemical reactions of tricarbonylchromium phthalimide complexes with respect to the “stereodirecting” effect of the $\text{Cr}(\text{CO})_3$ group. With this background, it is of considerable interest to exploit the chemical and stereochemical reaction potential of tricarbonylchromium phthalimide complexes for the synthesis of nitrogen containing heterocycles.

We are highly motivated to gain a better insight into the transformations and stereochemistry in the reaction involving the chiral tricarbonylchromium complex *N*-acyliminium intermediate. Concerning the importance for synthesis of valuable different optically active 3-substituted isoindol-1-ones **52**, asymmetric synthetic methodology using planar chiral tricarbonylchromium complex *N*-acyliminium ion is of interests to be developed, in which Cr(CO)₃ group could act as non-chiral auxiliary building block for the diastereoselective synthesis.

Two possible retrosynthetic routes are depicted below. Both routes rely on an enantioselective reduction strategy to provide the complex of α -alkoxylactam **55** or α -hydroxylactam complex **56** as the precursor for chiral tricarbonylchromium *N*-acyliminium ion **54**. In route a, enantiomerically pure α -hydroxylactam **57** might be obtained by means of an enantioselective reduction. Then the conversion of α -hydroxylactam **57** into alkoxylactam **55** is necessary because of the efficiency in replacement of the alkoxy group rather than the hydroxy group. In route b, the complex **56** could also be obtained by nucleophilic addition reaction with different nucleophiles. The chiral tricarbonylchromium *N*-acyliminium ion **54** intermediate could be formed by enhance of Lewis acid. Then diastereoselective addition of a suitable nucleophile to tricarbonylchromium *N*-acyliminium ion **54** would give product type **53** with respect to the steric bulk effect of Cr(CO)₃ group. The final removal of Cr(CO)₃ group would afford the desired enantioenriched 3-substituted isoindol-1-ones **52** (Scheme 8).

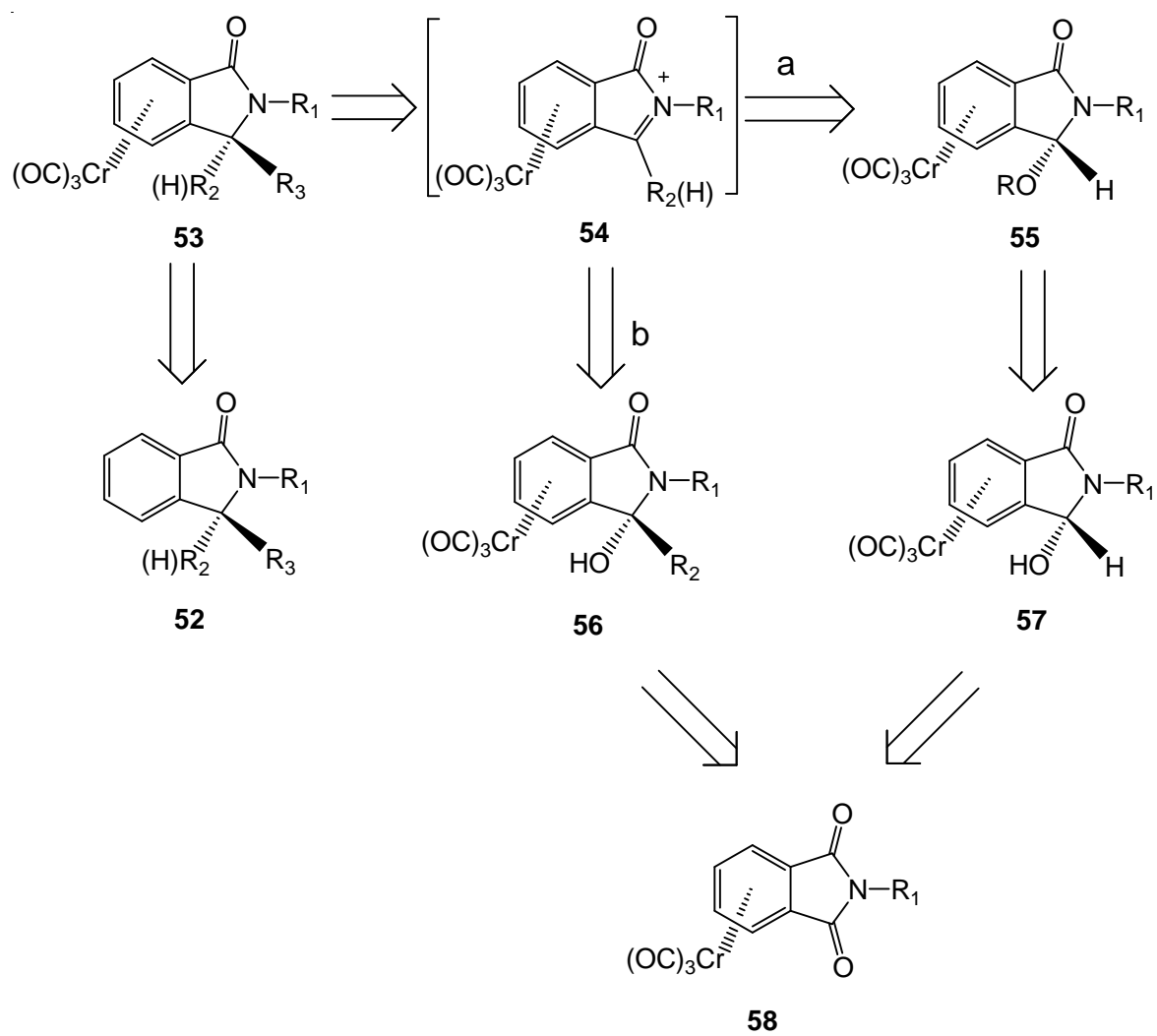

Scheme 8. Retrosynthetic routes for syntheses of optically active 3-substituted isoindol-1-ones **52**

Results and Discussion

1 Synthesis of tricarbonyl *N*-substituted phthalimide chromium (0) complexes

1.1 Introduction

Recent publications have established that nitrogen containing ligands can coordinate to metal fragments in different fashions, for example, as η^1 (N), η^6 (π C) and η^2 (N=C). The η^1 (N) complexes are obtained when a lone-pair in the heteroatom is available,^[92-94] or when a product of N-H bond activation is isolated.^[95] Thermal reactions of $M(\text{CO})_6$ with 1,2,3,4-tetrahydroquinoline (**59**) afford the corresponding (η^6 -arene)tricarbonylmetal complex (M = Cr, **60**; M = Mo, **61**, M = W, **62**). In contrast, thermolysis of the same hexacarbonyl complexes with 1,2,3,4-tetrahydroisoquinoline (**63**) affords the (σ -nitrogen) pentacarbonylmetal derivatives (M = Cr, **64**; M = Mo, **65**, M = W, **66**), only with $\text{Cr}(\text{CO})_6$ (η^6 -arene)tricarbonylmetal complex **67** was isolated (Scheme 9).^[96]

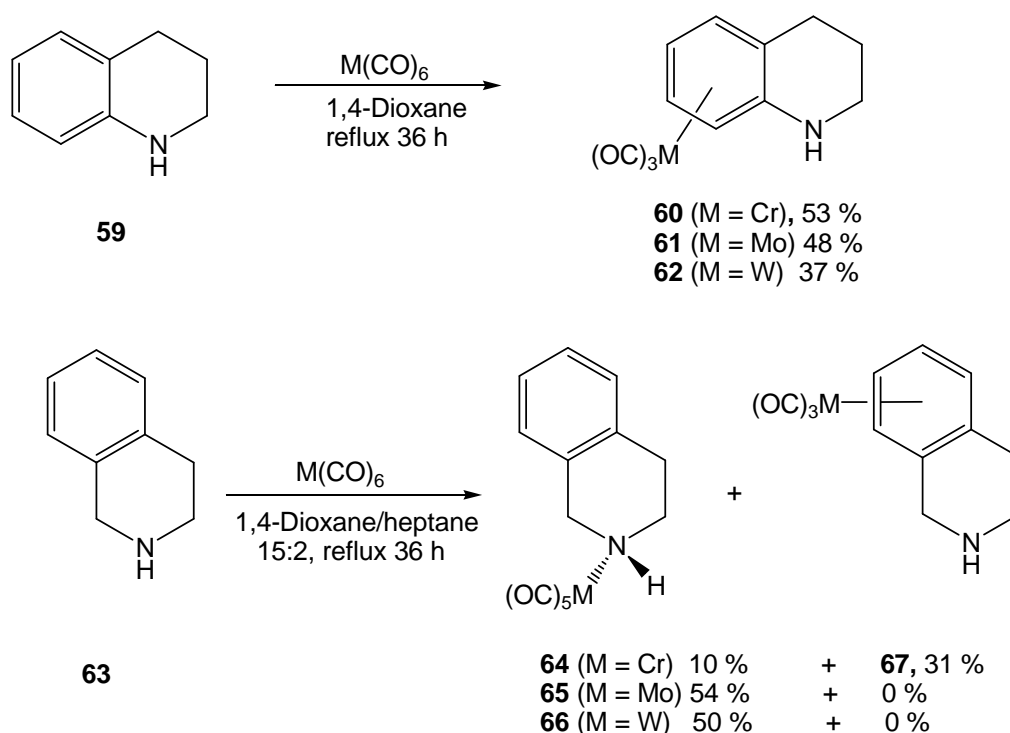

Scheme 9. Complexation 1,2,3,4-tetrahydroquinoline, -isoquinoline (**59**) and (**63**)

Also, complexation of 2-methoxy- α -methyl benzylamine (**68**) with $\text{Cr}(\text{CO})_6$ affords both (η^6 -arene)tricarbonylmetal complex **69** and (σ -nitrogen)pentacarbonylmetal derivative **70** (Scheme 10).^[97]

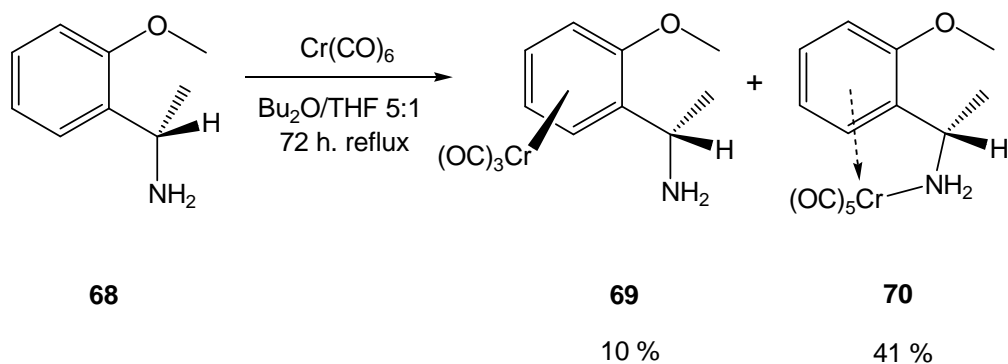

Scheme 10. Complexation of 2-methoxy- α -methyl benzyl amine (**68**)

1.2 Synthesis of tricarbonyl phthalimide chromium (**0**) (**72**)

With respect to the previous discussion, direct complexation of phthalimide (**71**) with hexacarbonyl chromium can give tricarbonyl phthalimide chromium (**72**) and/or *N*-pentacarbonyl phthalimide chromium (**73**) (Scheme 11).

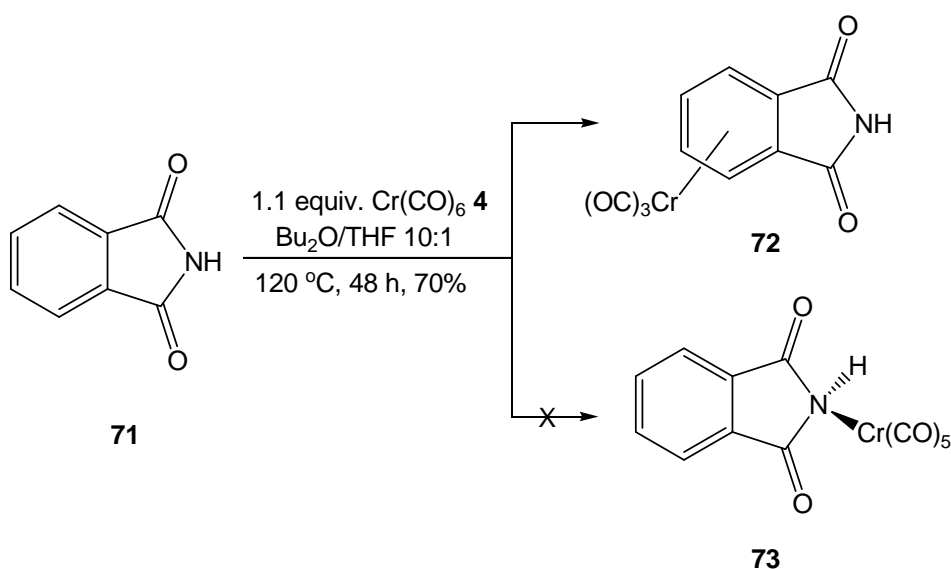

Scheme 11. Complexation of phthalimide (**71**)

Actually, we found that thermolysis of hexacarbonyl chromium (**4**) with phthalimide (**71**) resulted in the formation of only one product which is tricarbonyl phthalimide chromium (**72**) in 70 % yield after purification by column chromatography (66 %).^[98] The structure of

complex **72** was established based on the elemental analyses and spectral data. The ¹H-NMR and ¹³C-NMR spectra show the usual up field shift of both protons and carbon atoms resonances of the aromatic system coordinated to the Cr(CO)₃ moiety with respect to the corresponding free ligands. The ¹H-NMR spectrum of the product displays signals of aromatic protons that are shifted to higher field ~ 1.5-1.8 ppm in comparison to phthalimide. The spectrum also shows two multiplet signals at δ = 6.0 and 6.3 ppm corresponding to [5(6)-H] and [4(7)-H] respectively and singlet signal at 10.3 ppm assigned to NH proton. This is attributed to the shielding effect of the Cr(CO)₃ moiety attached to (η⁶-arene). Moreover, the ¹³C-NMR spectra also confirm the coordination of the Cr(CO)₃ moiety to the benzene ring, which shifts the chemical shift of carbon atoms up field in the range of δ 89-94 ppm. Finally, the constitution was also supported based on mass spectrum, which is in accord with complex **72**.

The accepted reason for the formation of tricarbonyl phthalimide chromium (**72**) rather than complex **73** is that the lone-pair of electrons on the nitrogen atom is not available as they are delocalized by resonance with the two carbonyl groups.

1.3 Synthesis of tricarbonyl (*N*-methyl, ethyl, vinyl, 2-bromoethyl phthalimide) chromium(0) (**78-81**)

Complexation of *N*-methylphthalimide (**74**),^[99] *N*-ethylphthalimide (**75**),^[100] *N*-vinylphthalimide (**76**)^[101,102] or *N*-(2-bromoethyl)phthalimide (**77**)^[103] by heating at 120 °C with hexacarbonyl chromium in Bu₂O/THF 10:1 for 17-35 h. gives the corresponding complexes **78-81** respectively in 11-61 % yields (Scheme 12).

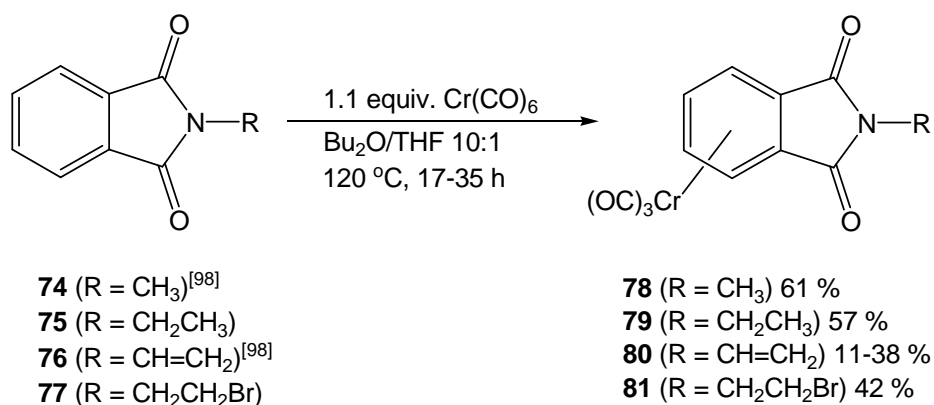

Scheme 12. Complexation of *N*-substituted phthalimides **74-77**

The tricarbonyl(phthalimides)chromium complexes **78-81** were purified by flash chromatography on SiO₂, eluting with TBME / PE (1:1 to 4:1) as red solids, which are moderately air stable, the unconverted free ligand eluted first from the column with less polar eluent.

The constitution of the complexes **78-81** was confirmed on the basis of elemental analysis and spectral data. The IR spectra of compounds **78-81** show three absorption bands at $\tilde{\nu} = 1980-1974, 1891-1893, 1771-1761 \text{ cm}^{-1}$, assigned to the Cr(CO)₃ group in addition to the carbonyl absorption band of the amide group at $1704-1653 \text{ (s) cm}^{-1}$. The ¹H NMR and ¹³C NMR spectra of complexes **78-81** show the usual up field shift of the proton and carbon resonances of the aromatic system with respect to the corresponding free ligands. *N*-Methyl phthalimide complex **78** has singlet signal at $\delta = 3.13 \text{ ppm}$ corresponding to the methyl group, also *N*-ethyl phthalimide complex **79** has two signals, one triplet at $\delta = 1.26 \text{ (} J = 6.3 \text{ Hz)}$ corresponding to the methyl group and quartet signal at $\delta = 3.70 \text{ (} J = 6.5 \text{ Hz)}$ corresponding to methylene group. The vinyl group in complex **80** is easily recognized by the typical signal pattern of the terminal olefinic proton resonances at $\delta = 5.07 \text{ ppm}$ (${}^2J_{cis} = 9.8 \text{ Hz}$) and at $\delta = 6.03 \text{ ppm}$ overlapping with two signals of the aromatic ring; one highly deshielded internal alkenyl proton resonance is observed at $\delta = 6.75 \text{ ppm}$. Moreover *N*-(2-bromoethyl) phthalimide complex **81** shows two triplet signals at $\delta = 3.5 \text{ (} J = 6.8 \text{ Hz)}$ and $4.0 \text{ (} J = 6.9 \text{ Hz)}$ corresponding to two methylene groups (CH₂Br) and (NCH₂) respectively. The ¹H NMR and ¹³C NMR spectra of complexes **78-81** show similar chemical shifts of the all substituents on the nitrogen atom with that of the corresponding free ligand compounds **74-77**. This means these substituents are far from the shielding effect of the Cr(CO)₃ group. The ¹³C NMR spectra of complexes **78-81** show peaks at lower field at $\delta = 228.5-232.9 \text{ ppm}$ characteristic for tricarbonyl chromium group. The mass spectra show the molecular ion [M⁺] of the complexes **78-81** at $m/z = 297, 311, 309, [389, 391 \text{ (1:1)}]$ respectively. The peaks for [M⁺ - 2CO], [M⁺ - 3CO], [M⁺ - Cr(CO)₃] and [Cr]⁺ are also indicated.

The inefficient complexation of *N*-vinylphthalimide (**76**) may be due to the thermal instability of the complex **80** at high temperature for long time. When the reaction time was extended to three days the yield decreased dramatically to 11 % with recovering the free ligand by column chromatography. However, complexation of *N*-vinylphthalimide through arene exchange using Kündig's complexation reagent tricarbonylchromium naphthalene complex (**18**) did not significantly improve the yield of the complex **80** (44 %).

In order to improve the yield of *N*-vinylphthalimide complex **80**, another synthetic pathway has been suggested, starting from tricarbonylchromium phthalimide complex **72**, which was prepared by direct complexation of phthalimide (**71**) with hexacarbonylchromium in Bu₂O/THF at reflux for 2-3 days. Complex **72** could be efficiently converted into its potassium salt **82** as an air stable orange solid by treatment with KOH in 93 % yield. Trials to prepare *N*-vinylphthalimide complex **80** through the reaction of complex **82** with vinyl bromide utilizing the method common for the free ligand failed,^[102] presumably because of the high reaction temperature and the long reaction time. Finally despite palladium catalytic vinylation of phthalimide gives excellent yield 86 % of vinyl phthalimide (**76**),^[101] no reaction with the corresponding complex took place, only recovering the starting material (Scheme 13).

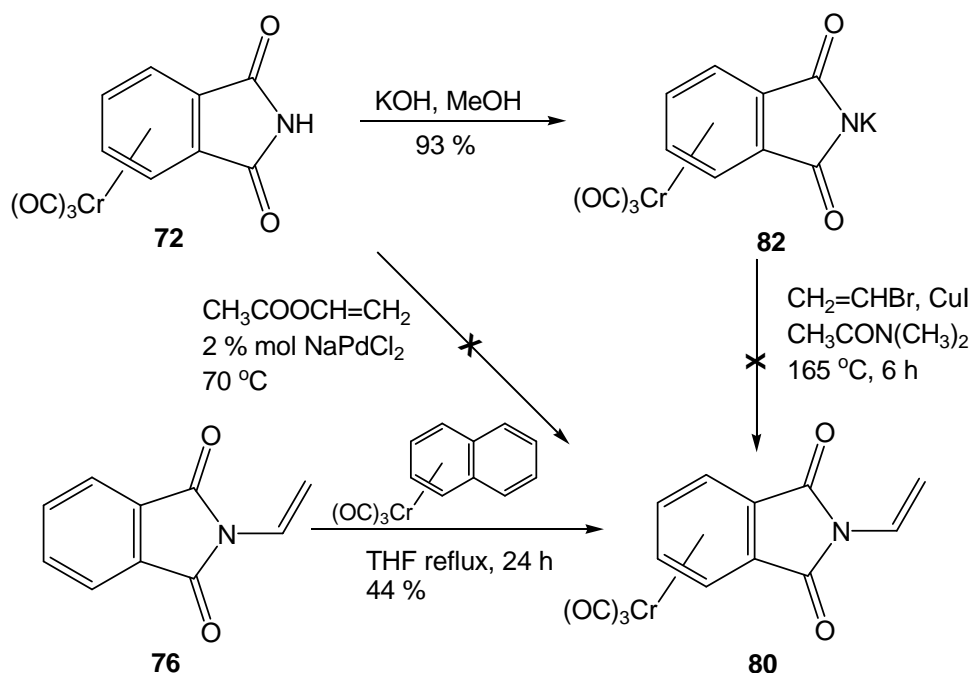

Scheme 13. Synthetic pathway for synthesis of tricarbonyl *N*-vinylphthalimide chromium **80**

The direct complexation of 1,3-indandione (**83**) and indantrione (**86**) using hexacarbonyl chromium did not succeed. This can be attributed to the electron deficiency of the aromatic ring acquired by the neighbouring electron withdrawing carbonyl groups. To overcome this problem, our group used another strategy to increase the electron density of the benzene ring through converting the carbonyl groups into the corresponding acetals. With respect to this strategy, the acetals (**85**) and (**88**) are prepared and successfully afford the corresponding

complexes with high yield (82 %). Deprotection of the acetal complex with half-concentrated sulphuric acid afforded the complex **84** in high yield (Scheme 14).^[20]

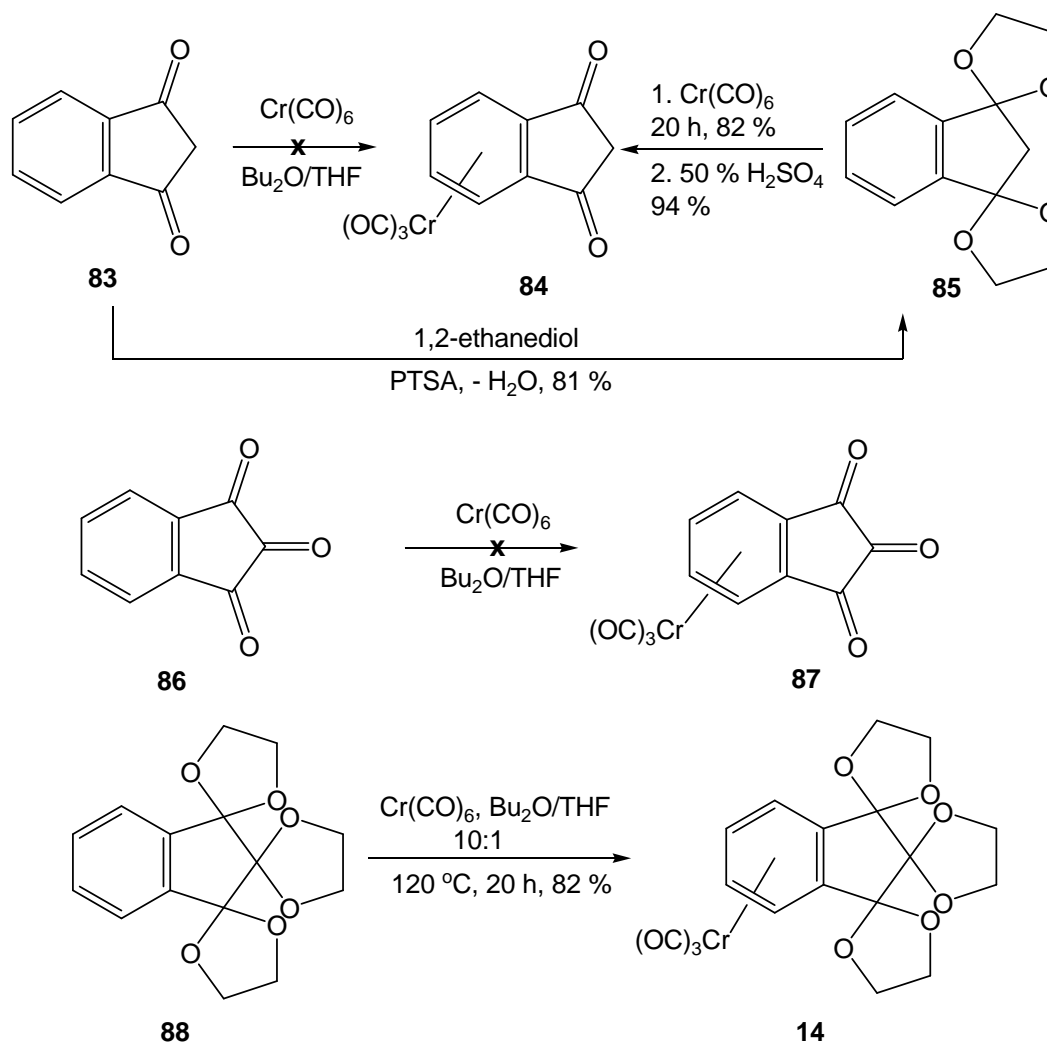

Scheme 14. Acetal route for complexation of 1,3-indandione (**83**) and indantrione (**86**)

Increasing the electron density of the aromatic ring of *N*-vinyl phthalimide (**76**), can be achieved by acetal formation of **76** or by reducing one carbonyl group using NaBH_4 . Firstly, the reaction of vinyl phthalimide with 1,2 ethanediol in presence of a catalytic amount of *para*-toluene sulfonic acid lead to formation of compound **90** instead of the half acetal acetal or the acetal compound **89**. This is due to the reactivity of vinyl group towards nucleophilic addition reaction in acidic condition. The structure of the formed product was established based on the spectral data. The IR spectrum of compound **90** revealed absorption bands at $\tilde{\nu} = 3315\text{ cm}^{-1}$ assigned to the OH group and 1687 cm^{-1} indicated the presence of CO groups. The ^1H NMR spectrum (200 MHz, CDCl_3) shows doublet signal at $\delta = 1.82$ ($J = 6.3\text{ MHz}$)

assigned to the methyl group and multiplet signal at $\delta = 3.7$ ppm (four protons) corresponding to two methylene groups, also the quartet signal at $\delta = 5.7$ ($J = 6.3$ MHz) is assigned to CH proton, In addition to multiplet signals at $\delta = 7.9$ ppm corresponding to the four aromatic protons.

Also reduction of *N*-vinyl phthalimide (**76**) using NaBH_4 afforded 2-vinyl-3-hydroxyisoindol-1-one (**91**) in 93 % yield.^[104] The subsequent complexation of compound **91** with hexacarbonylchromium in $\text{Bu}_2\text{O}/\text{THF}$ (10:1) by heating at refluxing was unsuccessful to afford complex **92**.^[98] This is possibly due to the low solubility of **91** in the reaction solvents that inhibit the complexation (Scheme 15).

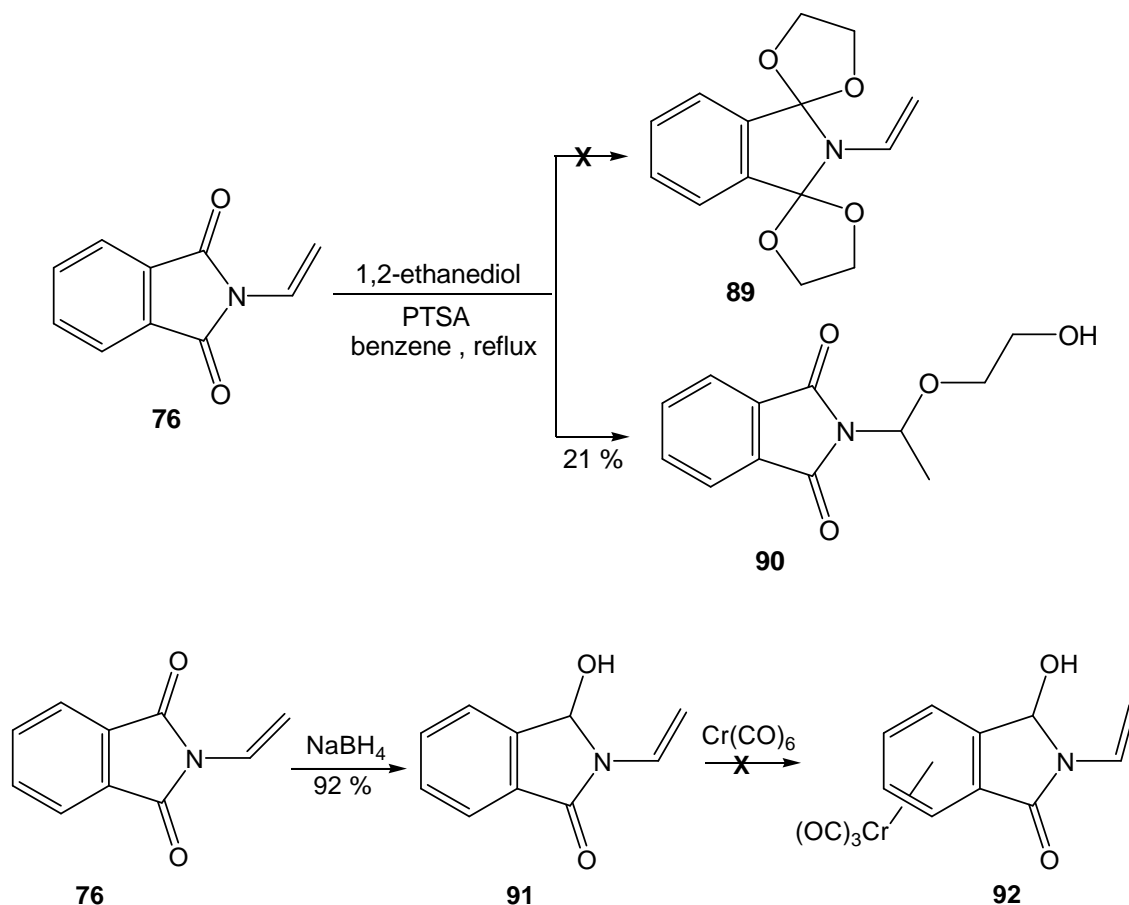

Scheme 15. Acetal route for complexation of *N*-vinyl phthalimide (**76**)

1.4 Synthesis of tricarbonyl (*N*-phenyl phthalimide) chromium (0) (**101**) and (**102**)

It was reported in complexation of 1-phenylpyrroles **93**, **94**, the $\text{Cr}(\text{CO})_3$ group can be coordinated either with the benzene or with the pyrrole ring. Physical measurements indicate a considerable donor character of the pyrrole ligand in these complexes. Nevertheless, they are rather less stable than other arene metal tricarbonyls. Also the product depends on the complexation reagent, while $(\text{CH}_3\text{CN})_3\text{Cr}(\text{CO})_3$ gave only complex **95**, $\text{Cr}(\text{CO})_6$ gave both complexes **96** and **97**. Also when the reaction time was increased the most stable complex **99** was obtained only (Scheme 16).^[105]

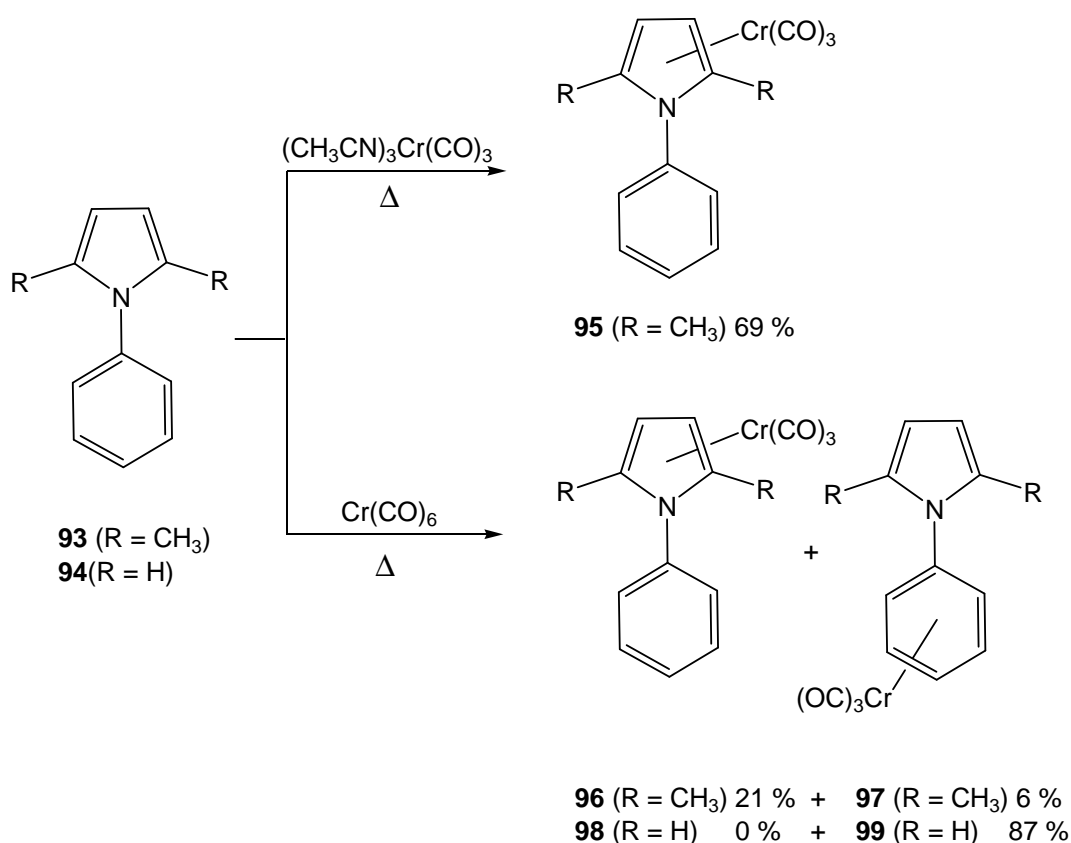

Scheme 16. Complexation of phenylpyrroles **93**, **94**

With respect to the previous discussion, Complexation reaction of *N*-phenyl phthalimide (**100**) can afford one, two or three complexes **101-103**, because $\text{Cr}(\text{CO})_3$ group can be coordinated with either or both of the benzene ring of phthalimide and aryl groups (Scheme 17).

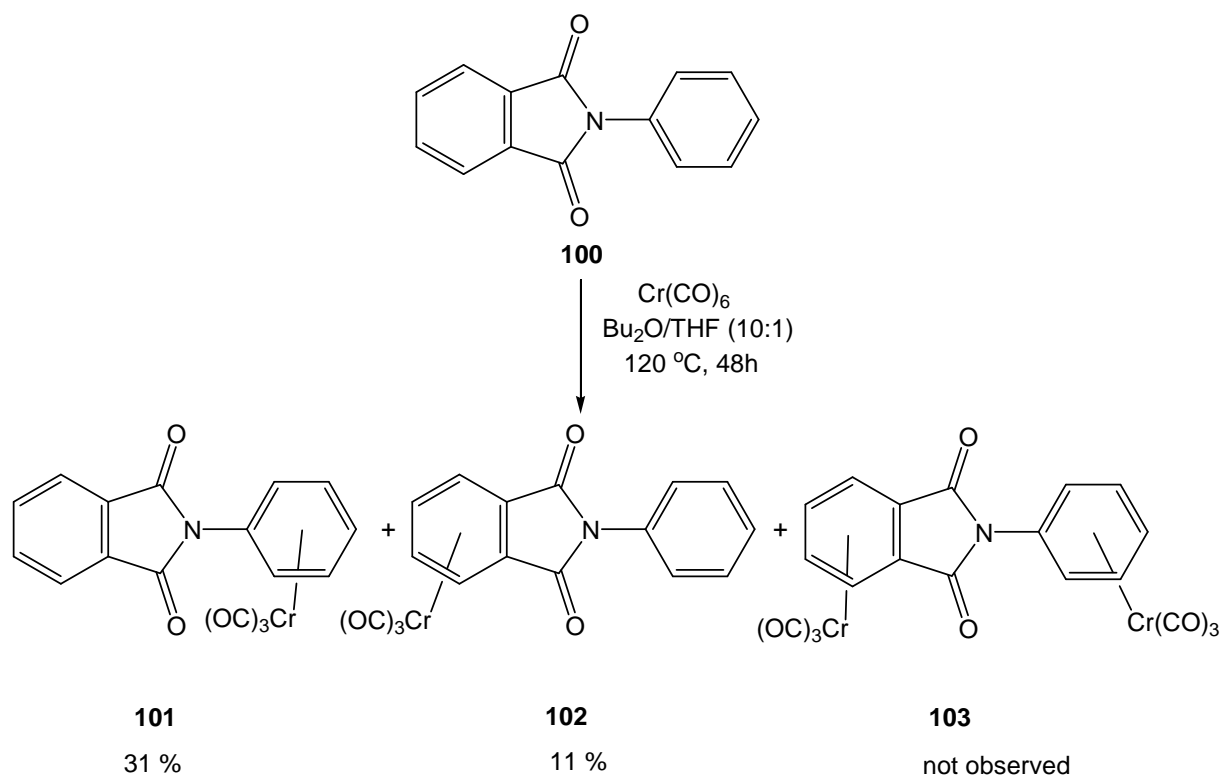

Scheme 17. Complexation of *N*-phenyl phthalimide (**100**)

The reaction mixture of *N*-phenyl phthalimide (**100**) and hexacarbonyl chromium in $\text{Bu}_2\text{O/THF}$ (10:1) was heated at $120\text{ }^\circ\text{C}$ for two days, then the crude products were separated by flash chromatography (200 x 20 mm, PE / TBME 1:3) to give 31 % of tricarbonyl (*N*- η^6 phenyl phthalimide) chromium (0) (**101**) as a yellow solid. m.p. $162\text{ }^\circ\text{C}$, followed by (TBME) to give 11 % of tricarbonyl(*N*-phenyl η^6 phthalimide)chromium (0) (**102**) as a red solid. m.p. $157\text{ }^\circ\text{C}$. This result agree with the theoretical expectation because of deactivating of di-*ortho* carbonyl groups in the phthalimide, so the tricarbonylchromium group prefer coordination with benzene ring rather than phthalimide moiety because of its high electron density.

The structures of the complexes **101** and **102** were established based on the elemental analysis and spectral data. The IR spectra of compounds **101** and **102** show characteristics bands of the Cr(CO)_3 group and carbonyls of the imide group. The ^1H NMR and ^{13}C NMR spectra of complexes **101** and **102** show the usual and up field shift of the protons and carbon atoms of aromatic system, which used to distinguish between compounds **101** and **102**. The ^1H NMR spectrum of tricarbonyl(*N*- η^6 phenylphthalimide)chromium (0) (**101**) shows five protons up field at $\delta = 5.3\text{-}5.9$ ppm assigned to the phenyl group and four protons in the usual aromatic rang at $\delta = 7.8\text{-}7.9$ ppm, this indicate that Cr(CO)_3 coordinated to benzene ring. Moreover the ^{13}C NMR spectrum shows four different siganls up field at $\delta = 89.4, 90.7$ and 90.8 ppm for

five CH carbon atoms in addition to the quaternary carbon at 106.3 ppm corresponding to the phenyl group. Also there are three different signals in the usual aromatic range at $\delta = 124.0$, 130.9 ppm and the quaternary carbon at $\delta = 135.0$ ppm for phthalimide, in addition characteristics signals of the $\text{Cr}(\text{CO})_3$ and imide's carbonyl groups at $\delta = 231.9$ and 166.1 ppm respectively. On the other hand, the ^1H NMR spectrum of tricarbonyl(*N*-phenyl η^6 phthalimide)chromium (0) (**102**) shows four protons up field at $\delta = 5.5$ -6.1 ppm and five protons in the aromatic range $\delta = 7.3$ -7.4 ppm, this indicates that $\text{Cr}(\text{CO})_3$ coordinated to phthalimide moiety. Moreover the ^{13}C NMR spectrum shows three different signals up field at $\delta = 87.5$, 90.1 and 90.8 ppm for phthalimide moiety and different four signals in the aromatic range at $\delta = 126.7$, 128.7, 129.2 and 130.9 ppm for phenyl group, in addition characteristics signals of the $\text{Cr}(\text{CO})_3$ and imide carbonyl groups at $\delta = 228.7$ and 166.3 ppm respectively. We found in the ^{13}C NMR spectra of **101** and **102** that the signal corresponding to the $\text{Cr}(\text{CO})_3$ in complex **102** is shifted up-field (3.2 ppm) in comparison with complex **101** this also shows the higher electron density of the phenyl group, which increases the back-bond donation from the chromium atom to the carbonyl groups.

A survey of the literature^[106-117] confirmed that, the π -complexes of transition metals with polycyclic aromatic hydrocarbons, in which only a part of the ligand perimeter accessible for coordination is involved in bonding to a metal atom, typically display high ability. Among the dynamic processes that may occur in these compounds are intramolecular inter-ring haptotropic rearrangements (IHR), which entail migration of an L_nM fragment from one position of the ligand to another. This type of thermally induced rearrangement was observed previously for various tricarbonyl chromium complexes with polycyclic aromatic hydrocarbons ligands,^[107,108] in particular with naphthalene **103**, **104**^[109-111] and biphenyl **105**, **106**^[112,113] derivatives (Scheme 18). In such complexes the $\text{Cr}(\text{CO})_3$ fragment is inert, non-coordinating solvents like decane or C_6F_6 at 80–170 °C intramolecularly shifts between substituted and unsubstituted rings of the ligand with an activation barrier of 27–33 kcal mol⁻¹ (η^6 , η^6 -rearrangements).^[110,114]

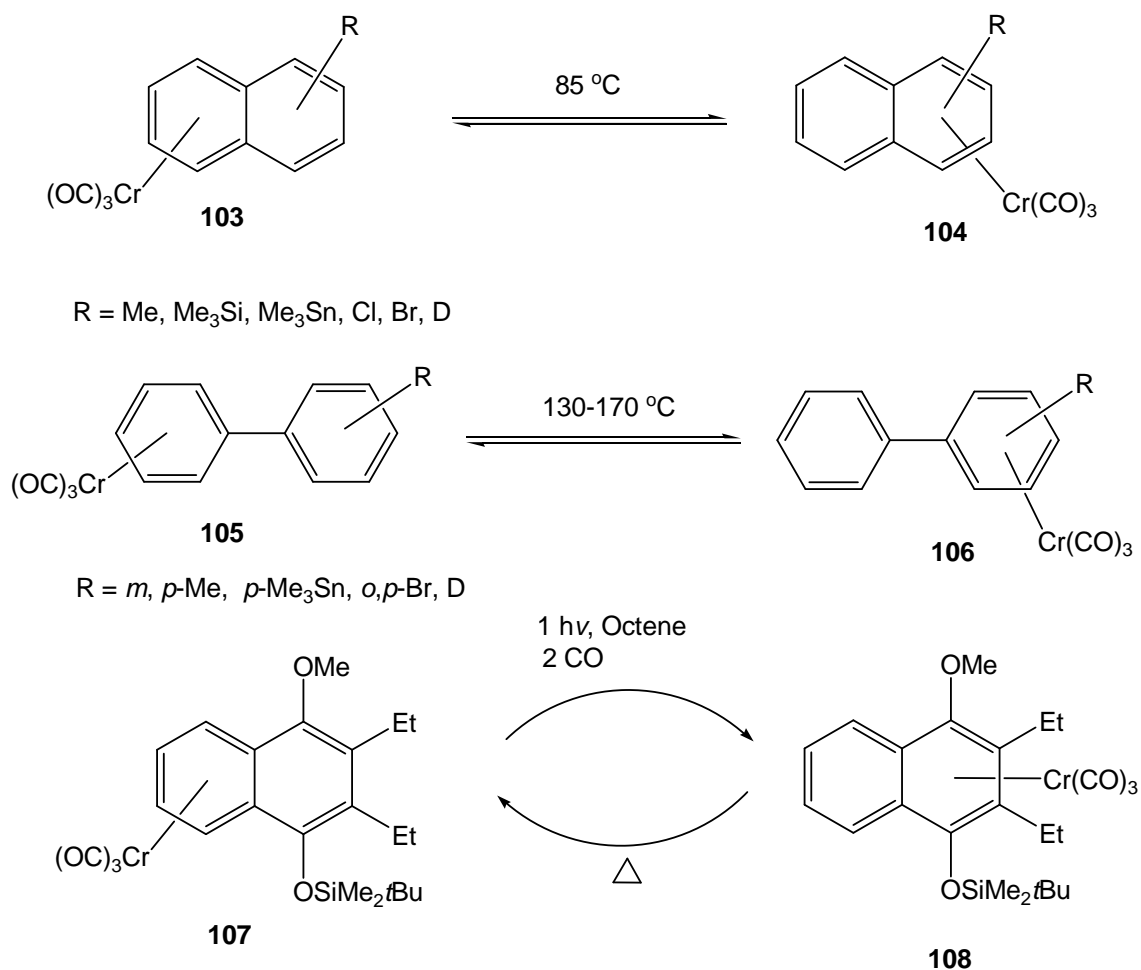

Scheme 18. Haptotropic rearrangement of the naphthalene and biphenyl derivative complexes

Moreover, 1,2-dihydro-2-phenyl-1,2-azaborine (**109**) reacts with $Cr(CO)_3(CH_3CN)_3$ in THF at 50 °C to form the $Cr(CO)_3$ complex **110** in which the chromium is η^6 -bound to the heterocyclic ring. Heating **110** in THF causes it to isomerize to complex **111**, in which the chromium is η^6 -bound to the phenyl ring. The $Cr(CO)_3$ group of **111** may be switched back to the heterocyclic ring by base conversion to the anion **112**, followed by thermal isomerization to anion **113**. Protonation of **113** re-forms **110** (Scheme 19).^[117]

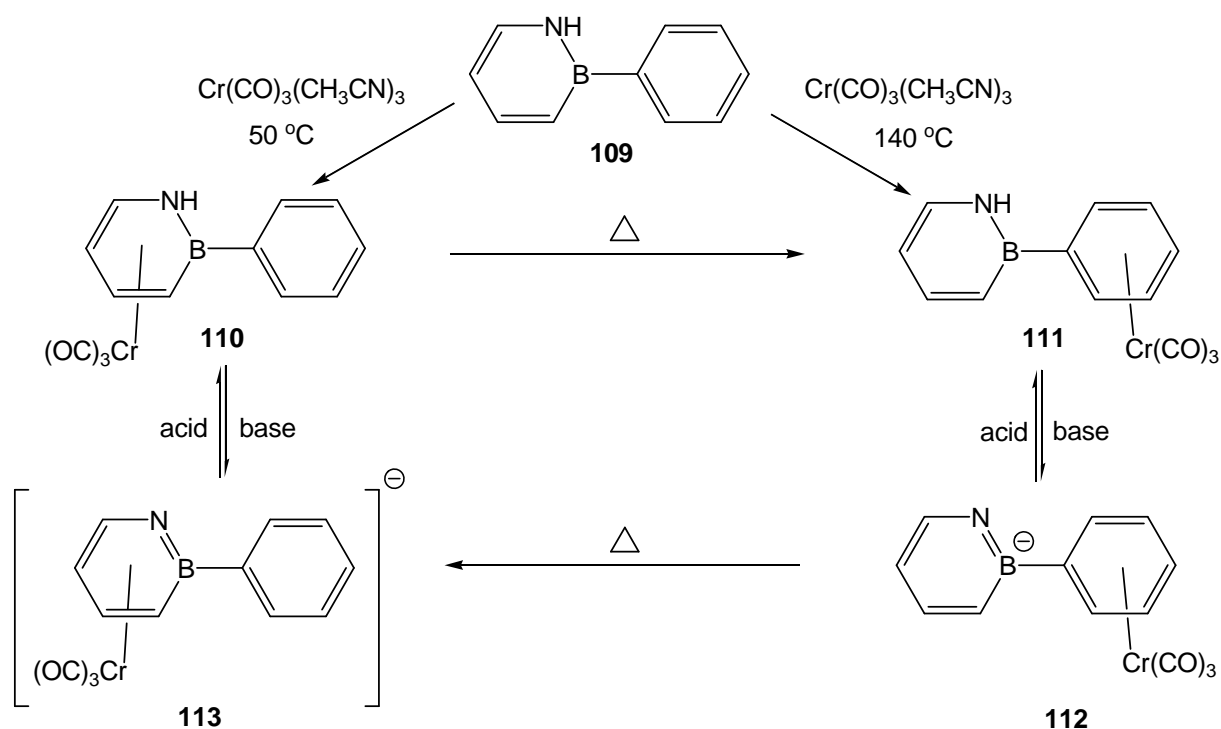

Scheme 19. Complexation and Haptotropic rearrangement of the 1,2-Dihydro-2-phenyl-1,2-azaborine (**109**)

In light of the above, and the progress of the complexation reaction of phenyl phthalimide, in which only one yellow complex is formed in addition to the starting material (indicated by TLC) after 30 min. of the reaction time. One hour later the solution became pale red and TLC shows two spots yellow and red, The red colour of the reaction mixture became more deeper with time, which can be interpreted on the basis of haptotropic rearrangement. This led us to investigate the possibility of haptotropic rearrangement.

Attempts to increase the yield of complex **102** using haptotropic metal migration by increasing both reaction time to five days instead of two days and reaction temperature to $135\text{ }^\circ\text{C}$ instead of $120\text{ }^\circ\text{C}$, but there is no significant change in the percent of both **101** and **102**. Also in a separate experiment complex **101** was dissolved in Bu_2O and heated at $135\text{ }^\circ\text{C}$ for 24 hours but no formation of complex **102**. Therefore, we did not notice any migration of the tricarbonyl group in *N*-phenyl phthalimide complexes. This may be due to the electron-deficiency of phthalimide or because of the absence of conjugation between the phenyl group and the benzene ring of phthalimide. These results agree with literature, that half-sandwich $\text{Cr}(\text{CO})_3$ complexes of fused arenes are suitable compounds for haptotropic rearrangements along extended π -ligand systems and the isomerization may result from an intramolecular metal shift during which the metal fragment remains coordinated to the π -electron-system.

This implies that the metal moiety remains attached to the same face of the arene ligand throughout the whole process. This mechanism fulfills the requirements of a haptotropic metal migration which has to proceed strictly intramolecularly. The extent to which intermolecular mechanisms contribute to the isomerization may increase with increasing polarity and donor properties of the solvent and with increasing temperature.^[6]

We obtained complex **102** in low yield because of the electron deficiency on the phthalimide moiety in comparison with the phenyl group. So we try to direct the coordination of the $\text{Cr}(\text{CO})_3$ group towards the phthalimide moiety instead of phenyl group, this can be achieved by decreasing the electron density in the phenyl group with electron-withdrawing substituents. So we thought that *N*-(2,4-dinitrophenyl) phthalimide (**104**) will be an ideal precursor for this propose. Unfortunately the introduction of two nitro groups, not only deactivate the phenyl group to complexation but also deactivate the whole molecule (Scheme 20).

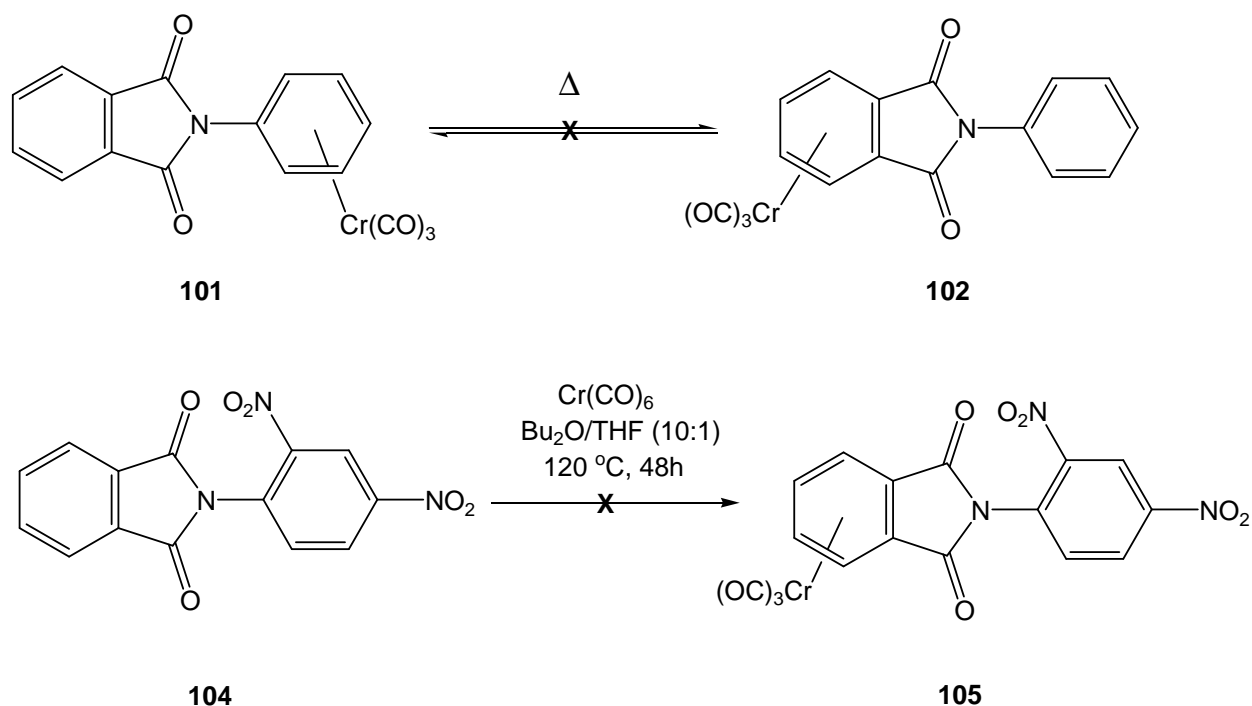

Scheme 20. Haptotropic rearrangement of complexes **101,102** and complexation of **104**

1.5 Proposed fragmentation pattern of tricarbonyl *N*-substituted phthalimide chromium (0) 72, 78-81 and 101

In contrast to hexacarbonyl chromium and bis-arene complexes, which have been studied repeatedly by mass spectrometry, comparatively few papers have been devoted to a study of the intermediate compounds, namely the tricarbonyl arene chromium complexes. Of the large number of compounds belonging to this class, only the mass spectrum of tricarbonyl benzene chromium has been studied in adequate detail.^[118-121]

The relative intensities of some ion peaks in the mass spectra of the tricarbonyl(phthalimides) chromium(0) complexes have been investigated. The peaks corresponding to the molecular ion M^+ has a moderate intensity. Peaks corresponding to consecutively CO loose are present. Also peaks corresponding to free *N*-substituted phthalimides are present, which indicates the decomplexation process. In addition to the base peak, which represent the chromium cation.

A substantial difference in the intensity of the lines of the $CrCO^+$ ($m/z = 80$) and Cr-Phthalimide ions. Also the absence of the $Cr(CO)_2^+$ and $Cr(CO)_3^+$ ions peaks, testify to the predominant cleavage of carbon monoxide from M^+ , which reflects the greater stability of the Cr- Phthalimide bond when compared with the Cr-CO bond. (The average energy values for cleavage of the Cr- C_6H_5 and Cr-CO bonds are respectively equal to 40.5^[122] and 27.9^[123] kcal/M.) The initial steps in the fragmentation of M^+ are the successive cleavage of two CO molecules from it. Then the fragmentation of the phthalimide $CrCO^+$ ion proceeds in two directions. Parallel with the cleavage of CO and the formation of the phthalimide Cr^+ ion a partial cleavage of phthalimide with the formation of the $CrCO^+$ ion occurs. Finally, *N*-substituted phthalimides loose RNCO radical to form benzocyclopropanone, followed by loosing acetylene molecule (Table 1) (Scheme 21).^[124]

Table 1. The characteristic peaks in the mass spectra of complexes **72**, **78-81** and **101**

Prominent fragment ions m/z (relative abundance, %)

Ion	Assignment	72	78	79	80	81	101
<i>a</i>	M^{*+}	283 (17)	297 (53)	311 (25)	309 (45)	389,391 (10),(10)	359 (12)
<i>b</i>	$M^{*+} - (CO)$	255 (0)	269 (0)	282 (0)	280 (0)	361,363 (0),(0)	331 (0)
<i>c</i>	$M^{*+} - 2(CO)$	227 (7)	241 (20)	255 (9)	253 (32)	333,335 (4),(4)	303 (5)
<i>d</i>	$M^{*+} - 3(CO)$	199 (47)	213 (97)	227 (99)	225 (83)	305,307 (10),(10)	275 (100)
<i>e</i>	$M^{*+} - Cr(CO)_3$	147 (97)	161 (25)	175 (15)	173 (33)	253,255 (4),(5)	223 (64)
<i>f</i>	$M^{*+} - [Cr(CO)_3 + RNCO^*]$	104 (82)	104 (12)	104 (6)	104 (10)	104 (8)	104 (15)
<i>g</i>	$C_6H_4^+$	76 (89)	76 (19)	76 (10)	76 (25)	76 (11)	76 (35)
<i>h</i>	$C_4H_2^+$	50 (16)	50 (8)	50 (4)	50 (12)	50 (14)	50 (9)
<i>i</i>	$Cr(CO)^+$	80 (8)	80 (7)	80 (6)	80 (25)	80 (12)	80 (5)
<i>j</i>	Cr^+	52 (100)	52 (100)	52 (100)	52 (100)	52 (100)	52 (67)

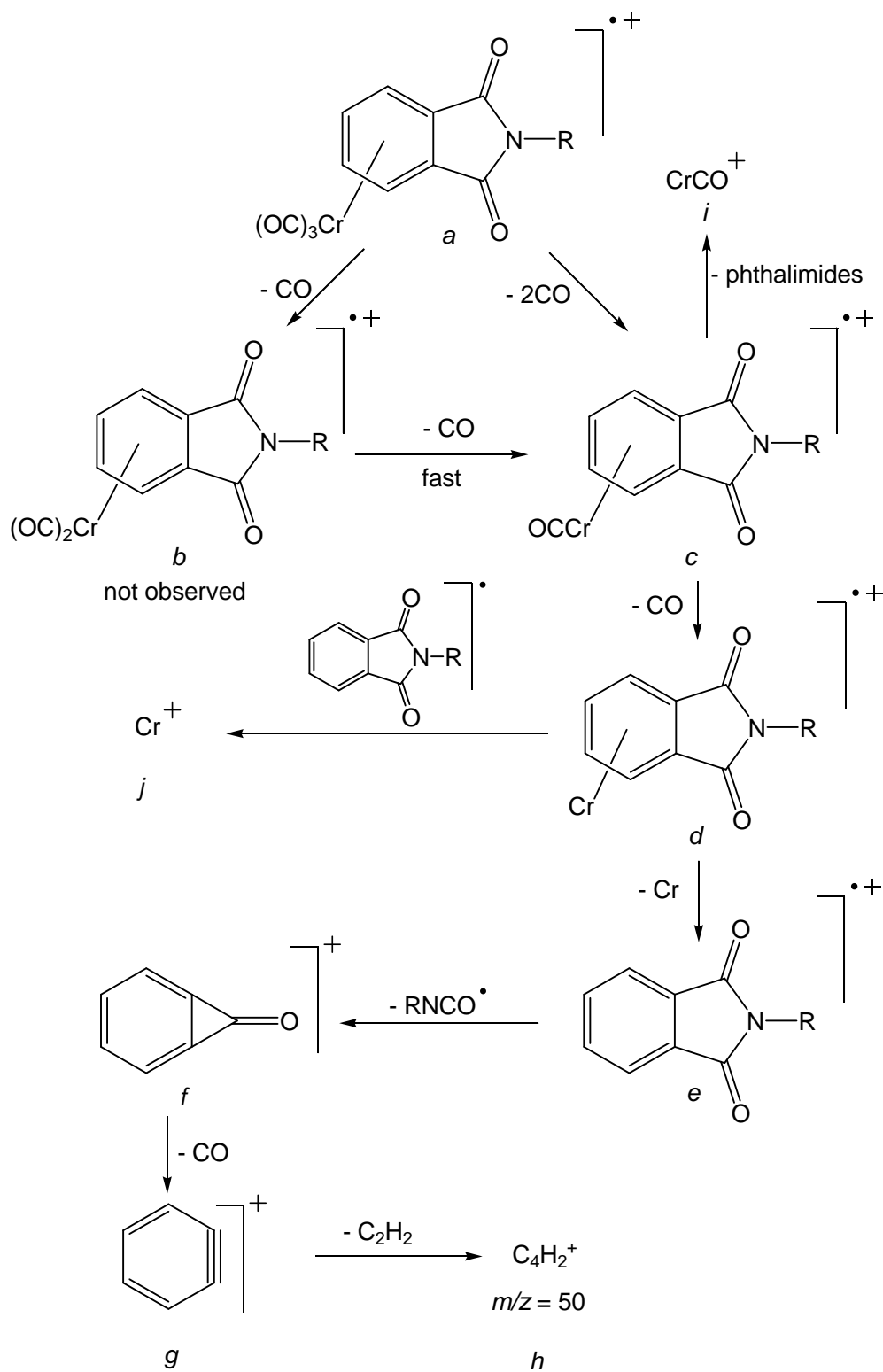

Scheme 21. Proposed fragmentation pattern of tricarbonyl *N*-substituted phthalimide chromium(0) **72, 78-81,101**

2 Photochemical substitution reaction of tricarbonyl *N*-substituted phthalimide chromium(0) complexes

2.1 Introduction

Many (arene)Cr(CO)₂PR₃ complexes have been synthesized in order to study metal–arene rotation barriers,^[125-131] changes in catalytic properties upon substitution of a carbonyl with a phosphine. For example the steric and electronic effect in complex **108** in formation of compound **109** in high stereoselectivity (Scheme 22).^[132-136] The ability to perform Sonogashira coupling reactions with terminal alkynes to form organometallic complexes with extended π -conjugation.^[137,138]

Although the substitution of a CO ligand by a phosphane decreases the propensity of the complexes towards the oxidative addition of the palladium(0) species into the carbon–chlorine bond, cross-couplings are still efficiently possible. Nevertheless, for a complete conversion of the coupling reaction of the chlorobenzene-Cr(CO)₂PPh₃ complex **106** the reaction time has to be extended to 24 h in a refluxing mixture of THF and triethylamine (Scheme 21). The coupling of the chlorobenzene-Cr(CO)₃ complex with terminal alkynes is complete within 3 h.^[139]

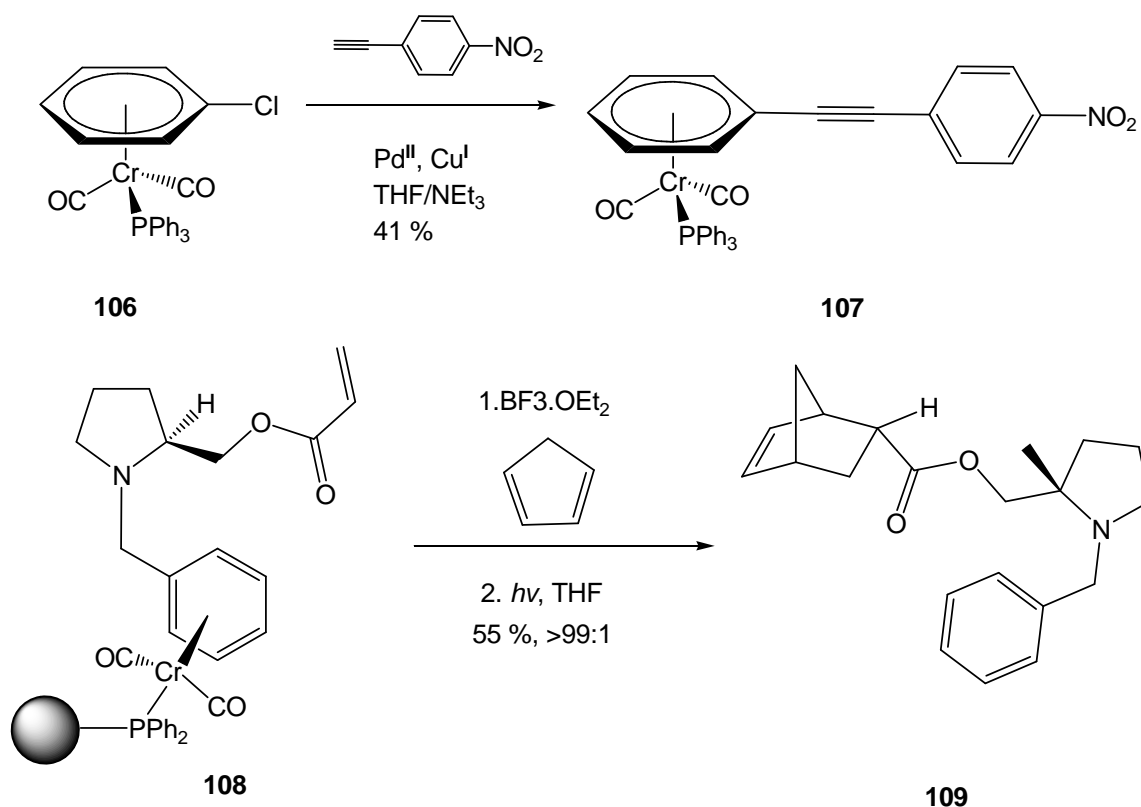

Scheme 22. Sonogashira coupling reaction of **106** and Diels–Alder reaction of **108**

Also, a number of mixed ligand η^6 arene chromium carbonyl complexes have been prepared and investigated for their ability to affect electronic modulation of arene chemistry. Modulation of the orbital density of arene chromium carbonyl complexes was originally demonstrated by Jaouen in elegant studies involving the ionization of mixed ligand chromium-complexed benzoic acids **110**.^[140] As expected, carboxylate acidity was strongly influenced by donor/acceptor contributions of the arene metal carbonyl system, and the observed pKa of the tricarbonylchromium derivative X (CO) reflects the potent withdrawing ability of this subgroup. The corresponding dicarbonyl monophosphites, approximately isoelectronic with the uncomplexed arene carboxylate, are notably less acidic, and the dicarbonyl monophosphine complex is more resistant to ionization than the parent carboxylate itself, a consequence of the donor ability of the phosphine group (Fig. 10).^[140]

Ring substituents also interact with the π orbitals of arene complexes, and traditional π -donor substituents (e.g., NEt_2 , NH_2 , OMe , F , Me) induce π -symmetry interactions with the complex, which can be monitored by concomitant lowering of the (CO) infrared carbonyl stretching frequencies,^[141] due to the ability of arene chromium carbonyl complexes that influence the electronic properties of both ring substituents and the π orbitals of the arene. The system that represent these effects, as depicted in **111** (Fig. 10).^[142]

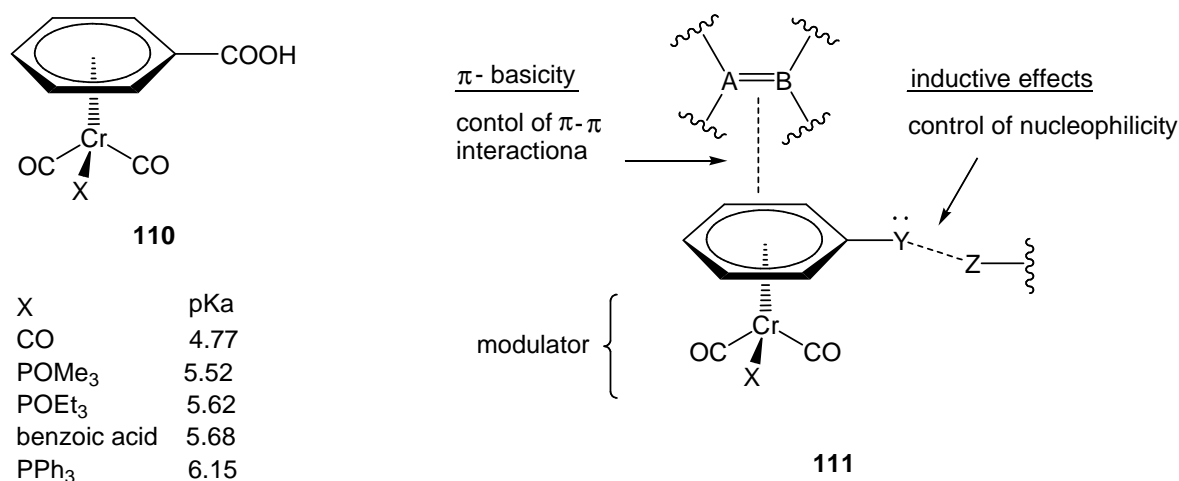
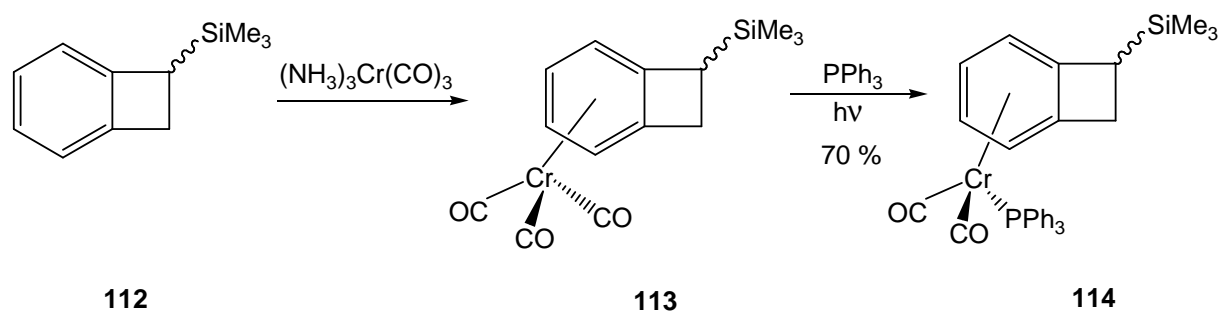

Figure 10. Electronic effects of changing CO group with electron-donor groups

Furthermore, (arene)Cr(CO)₂PPh₃ complexes have been synthesized in order to study the stereochemistry of these complexes. For example, complexation of the chiral ligands **112** take place on either side of the aromatic ring, thus generating another element of chirality, and

allowing formation of *exo*- and *endo*-diastereomers of complexes **113**. Photochemical ligand exchange was carried out with **113** to give *endo/exo*-dicarbonyl(1-trimethylsilylbenzocyclobutene)triphenylphosphane chromium(0) (**114**) in 70% yield. Then, Diastereoisomer ratios were determined by ^1H NMR, and signal assignments were verified by a NOE experiment. The proton-bearing substituents at the phosphine ligand make an NOE measurement possible, which confirms the assigned structure: Irradiation with the frequency assigned to *endo*-1-H causes an NOE for the signal assigned to the *ortho* protons of the PPh_3 ligand, whereas irradiation with the frequency assigned to the *ortho* protons of the PPh_3 ligand causes a corresponding NOE at the signal assigned to *endo*-1-H (Scheme 23).^[143]



Scheme 23. Complexation and photochemical ligand exchange of compound **112**

2.2 Synthesis of [Dicarbonyl(η^6 -*N*-substitutedphthalimide)triphenylphosphine] chromium (0) **115-117**

A series of mixed ligand complexes of the general type (phthalimides) $\text{Cr}(\text{CO})_2(\text{PPh}_3)$ has been prepared photochemically, starting from (phthalimides) $\text{Cr}(\text{CO})_3$. Triphenylphosphine (2 equiv.) was added to a solution of the tricarbonyl(phthalimide)chromium complexes **72**, **78**, **79** (1 equiv.) in toluene (30 mL). The reaction mixture was irradiated for 30 min to 3 h. with a 125 W mercury lamp using a quartz cell with continuous argon bubbling through the reaction mixture and continuous cooling using a water condenser. The reaction progress was monitored until TLC indicated no more starting material, then solvent was removed at reduced pressure and the crude product was purified by short-degassed column chromatography (SiO_2 , PE / TBME 1:2) Scheme 24.

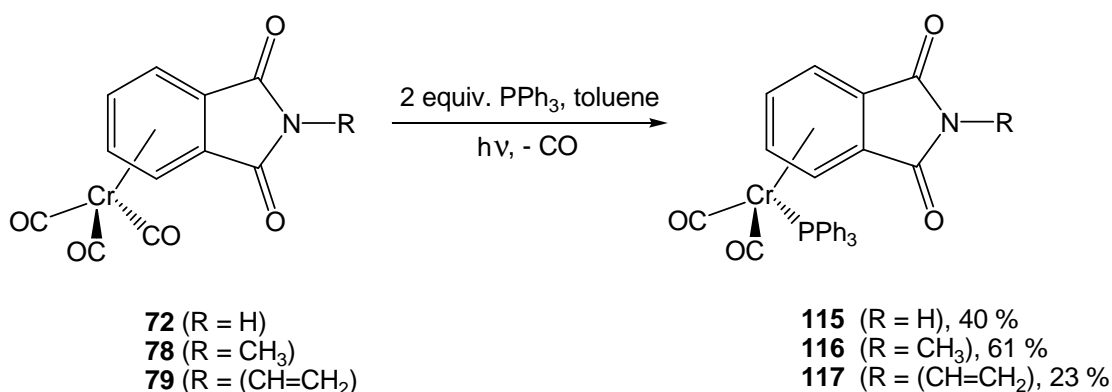

Scheme 24. Photochemical ligand exchange of complexes **72**, **78** and **79**

The new complexes **115-117** are dark brown solids while the starting complexes are red. This change may be due to the extension of the conjugation with the electron-rich triphenylphosphine. The constitutions of these complexes were confirmed based on the elemental analysis and the spectral data. The IR, ¹H-NMR and ¹³C-NMR spectra data of both (phthalimides)Cr(CO)₂(PR₃) and (phthalimides)Cr(CO)₃ compounds indicates that triphenylphosphine ligand is a powerful electron-donating and shielding ligand.

Firstly, the IR spectra of complexes **115-117** show the donor ability of the phosphine ligand in dicarbonyl monophosphine chromium complexes **115-117**, which decreases the carbonyl stretching frequencies in comparison with tricarbonyl chromium complexes. The electron-donation property of phosphine increases the electron density on the carbonyl carbon atoms and this decreases the CO bond order so the carbonyls vibrate at lower frequencies (Table 2).^[141]

Table 2. Carbonyls stretching frequencies (cm^{-1}) change after introduction of phosphine ligand

Substituents	Tricarbonyl (phthalimide) chromium complexes 72,78 and 79		Dicarbonyl phosphine (phthalimide) chromium complexes 115-117	
	R = H	1979	1928	1931
R = CH ₃	1974	1894	1920	1882
R = CH=CH ₂	1980	1892	1935	1872

The $^1\text{H-NMR}$ spectra of the compounds **115-117** display signals of aromatic protons at higher field, ca. 0.2-0.6 ppm in comparison with the tricarbonyl phthalimide chromium complexes. This attributed to the high shielding effect of the more bulky, electron-rich dicarbonyl phosphine chromium moiety. Moreover, the $^{13}\text{C-NMR}$ spectra show the aromatic signals in the range of $\delta = 84\text{-}94$ ppm. All benzene carbon atoms are shifted to high field with respect to tricarbonyl phthalimide chromium complexes except for C-5(6). Furthermore the chemical shifts of the carbonyls of $\text{Cr}(\text{PPh}_3)(\text{CO})_2$ are shifted to high field, ca. 7-10 ppm this agree with the decrease of bond order of CO. In addition the corresponding signals of CO appears as two peaks due to the phosphors-carbonyl coupling throw the metal and the coupling constants 2J ($^{31}\text{P}\text{-}^{13}\text{C}\text{O}$) are 21-30 Hz (Table 3).^[144,145] In addition the $^{13}\text{C-NMR}$ spectra show one, two and three cross coupling of phosphorous atom with the phenyl carbon atoms, and the greatest coupling constant is one-bond coupling $J_{\text{P-C}} = 36\text{-}37$ Hz, $^2J_{\text{P-C}} = 10\text{-}11$ Hz, $^3J_{\text{P-C}} = 9\text{-}10$ Hz.^[146,147]

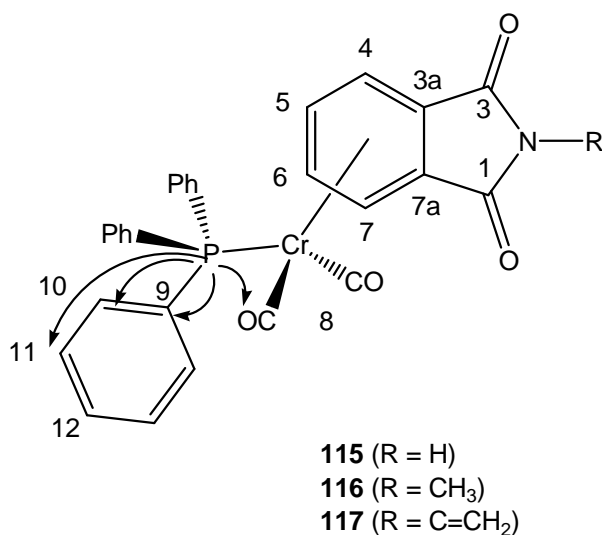

Table 3. The ^1H -NMR and ^{13}C -NMR spectra of tricarbonyl and dicarbonyltriphenylphosphine (characteristics signals)

Substituents	Tricarbonyl (phthalimides) chromium complexes 72,78,79		Dicarbonyl triphenylphosphine (phthalimides) chromium complexes 115-117	
	^1H -NMR 5(6)-H, 4(7)-H δ (ppm)	^{13}C -NMR $\text{Cr}(\text{CO})_3$ δ (ppm)	^1H -NMR 5(6)-H, 4(7)-H δ (ppm)	^{13}C -NMR $\text{Cr}(\text{CO})_2\text{PPh}_3$, $^2J_{\text{P-CO}}$ (Hz)
R = H	5.9, 6.3	231.6	4.8, 5.6	238.6, 238.8 (21)Hz
R = CH_3	5.5, 6.0	228.9	4.9, 5.6	238.9, 239.2 (30)Hz
R = $\text{CH}=\text{CH}_2$	5.4, 6.0	228.5	4.9, 5.8	238.4, 238.6 (21)Hz

The mass spectra of complexes **115-117** show the molecular ion peak with very low intensity reflecting the thermal-instability of these complexes. Also low intensity of the $(\text{M}^+ - 2\text{CO})$ peak, the absence of the $(\text{M}^+ - 2\text{CO} - \text{PPh}_3)$ peak and the appearance of a peak corresponding to CrPPh_3^+ reflect the negative effect of the phosphine ligand on the strength of Cr-Benzene bonds, which is weaker than in tricarbonyl complexes. The absence of the $(\text{M}^+ - \text{PPh}_3)$ peak indicates that the Cr-P bond is stronger than the Cr-CO bond. The basic peak in the mass spectra of complexes **115-117** is the triphenylphosphine cation which is stable fragment and decomposed as reported (Table 4)(Scheme 25).^[148]

Table 4. The characteristic peaks in the mass spectra of complexes **115-117**

Prominent fragment ions m/z (relative abundance, %)

Ion	Assignment	115	116	117
<i>a</i>	$M^{•+}$	517 (1)	531 (3)	543 (2)
<i>b</i>	$M^{•+} - (CO)$	489 (0)	503 (0)	515 (0)
<i>c</i>	$M^{•+} - 2(CO)$	461 (4)	475 (24)	487 (14)
<i>d</i>	$M^{•+} - 2(CO) - PPh_3$	199 (0)	213 (3)	225 (0)
<i>e</i>	$M^{•+} - Cr(CO)_2PPh_3$	147 (16)	161 (30)	173 (27)
<i>f</i>	$M^{•+} - [Cr(CO)_2PPh_3 + RNCO^*]$	104 (12)	104 (15)	104 (11)
<i>g</i>	$C_6H_4^+$	76 (14)	76 (22)	76 (15)
<i>h</i>	Cr^+	52 (9)	52 (65)	52 (45)
<i>i</i>	$CrPPh_3^+$	314 (8)	314 (7)	314 (6)
<i>j</i>	PPh_3^+	262 (100)	262 (100)	262 (100)
<i>k</i>	PPh_2^+	185 (13)	185 (12)	185 (11)
<i>l</i>	$PPh_2 - H_2^+$	183 (74)	183 (87)	183 (50)
<i>m</i>	$Ph_2 - H_2^+$	152 (10)	152 (11)	152 (8)
<i>n</i>	PPh^+	108 (41)	108 (39)	108 (37)

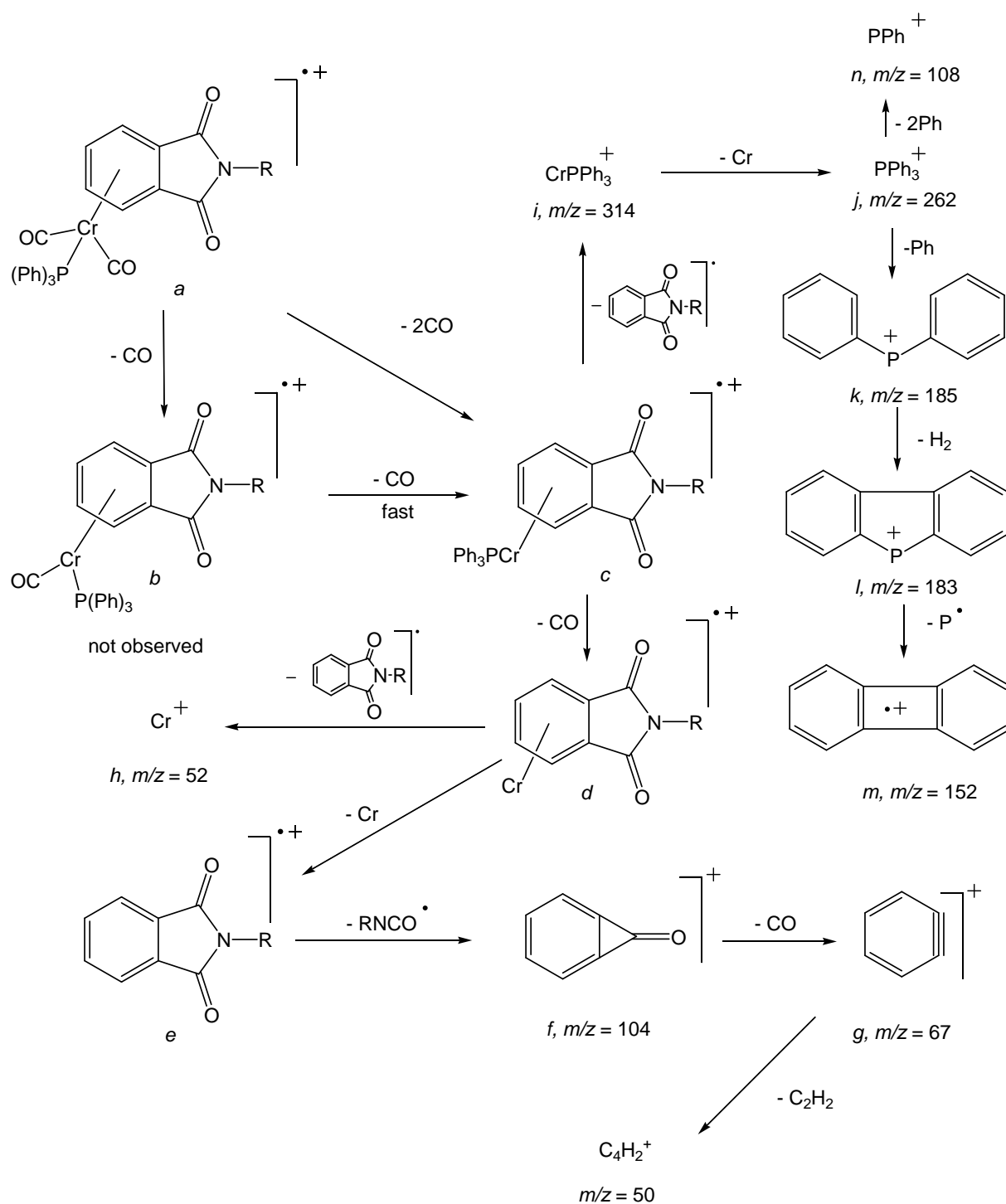

Scheme 25. Proposed fragmentation pattern of dicarbonyl (N-substituted phthalimide) triphenyl phosphine chromium (0) 115-117

2.3 Synthesis of [Dicarbonyl (η^6 -*N*-methyl phthalimide)trimethylphosphine , -triethyl phosphite] chromium(0) **118** and **119**, respectively.

Dicarbonyl phosphine/phosphite complexes **118** and **119** were prepared by irradiating mixture of tricarbonyl(*N*-methyl phthalimide)chromium complex (**78**) with trimethyl phosphine or triethyl phosphite, respectively for 30 min., using a 125 W mercury lamp in a quartz cell with continuous argon bubbling through the reaction mixture and continuous cooling using a water condenser. The reaction progress was monitored until TLC indicated no more starting materials, the solvent was removed at reduced pressure and the crude product was purified by short-degassed column chromatography (SiO₂, PE / TBME 1:2) (Scheme 26).

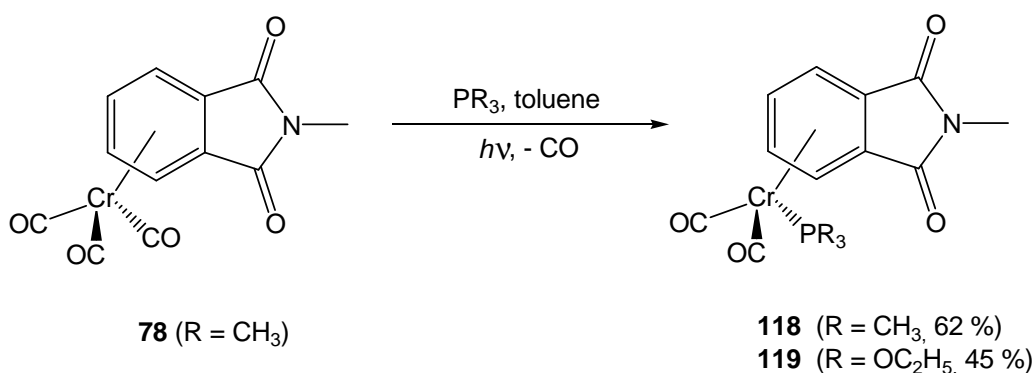

Scheme 26. Photochemical ligand exchange of complexes **78**

The chemical structures of these compounds were established based on the elemental analyses and spectral data. The IR spectra of complexes **118** and **119** have lower carbonyls stretching frequencies at (1917, 1867 and 1723) and (1931, 1844 and 1740) cm⁻¹ respectively in comparison with tricarbonyl chromium complex **87**. The ¹H-NMR spectrum of [dicarbonyl (η^6 -*N*-methyl phthalimide)trimethylphosphine] chromium(0) (**118**) shows the aromatic signals at δ = 5.38 and 5.80 ppm which are more down- field than corresponding triphenylphosphine complex **116**. On the other hand [dicarbonyl (η^6 -*N*-methyl phthalimide)triethylphosphite] chromium(0) (**119**) shows the aromatic signals at δ = 4.88 and 5.37 ppm which are up - field complexes **78**, **116**, **118**, that means the order of shielding effect of the replaced ligands is P(OEt)₃ > PPh₃ > P(CH₃)₃.

The IR spectral data of dicarbonyl phosphine/phosphite complexes displays the effect of phosphine and phosphite on the C≡O stretching frequencies. The carbon monoxide bonds to transition metals using "synergic π^* back-bonding." The bonding has three components, giving rise to a partial triple bond. A sigma bond arises from overlap of nonbonding electron pair on carbon with a blend of d, s, and p-orbitals on the metal. A pair of π bonds arises from overlap of filled d-orbitals on the metal with a pair of π -antibonding orbitals projecting from the carbon of the CO. The latter kind of binding requires that the metal has d-electrons, and that the metal is in a relatively low oxidation state (<+2). The π -bonding has the effect of weakening the carbon-oxygen bond compared with free carbon monoxide. Because of the multiple bond character of the M-CO linkage (Fig. 11). Also it is known that the electron density in arene chromium tricarbonyl complexes may be varied considerably by both the number and nature of ring substituents attached to the benzene ring. This is clearly reflected in the C≡O stretching frequencies.^[141,147,149,150]

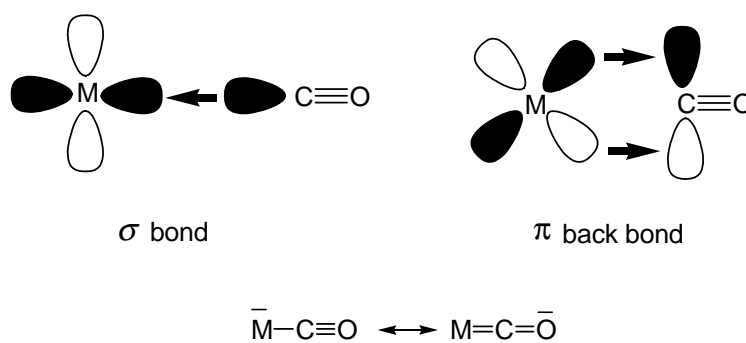

Figure 11. Metal carbonyl bond

Consequently increasing electron density on the metal will enhance back-bonding to the carbonyl ligands, leading to increased population of the antibonding π^* orbitals of the C≡O ligands and a concomitant lowering of the (C≡O) frequencies. In a simple valence bond picture, a relatively low frequency of the two C≡O stretching vibrations points to a relatively high electron density in the complex, as compared to (phthalimide)Cr(CO)₃.

3 Nucleophilic addition to tricarbonyl *N*-substituted phthalimide chromium (0) complexes

3.1 Introduction

A metal carbonyl moiety complexed to a conjugated π electron framework is known to prevent reagent approach from the same face of the molecule as occupied by the metal (*endo* face) and thereby enforce *exo*-selective additions. In arene tricarbonylchromium complexes, this attribute has been extensively harnessed to yield a large variety of target molecules of biological interest.^[151] In the course of these syntheses, *exo*-selective functionalizations at aryl, benzyl, or homobenzyl sites have been routinely achieved.^[151,152] In comparison, examples of effective *endo*-functionalization procedures that would permit more flexible synthetic designs are rare.^[153]

Piers and Worster have found that benzylic protons of *syn*- and *anti*-(1-methylindane)tricarbonylchromium **120** and **121** respectively undergo base catalyzed hydrogen-deuterium exchange fairly rapidly and stereoselectively. The ¹H NMR spectrum of the products indicate that only the benzylic protons, which are *anti* to the tricarbonylchromium moiety undergo exchange to give **122** and **123** respectively (Scheme 27).^[154]

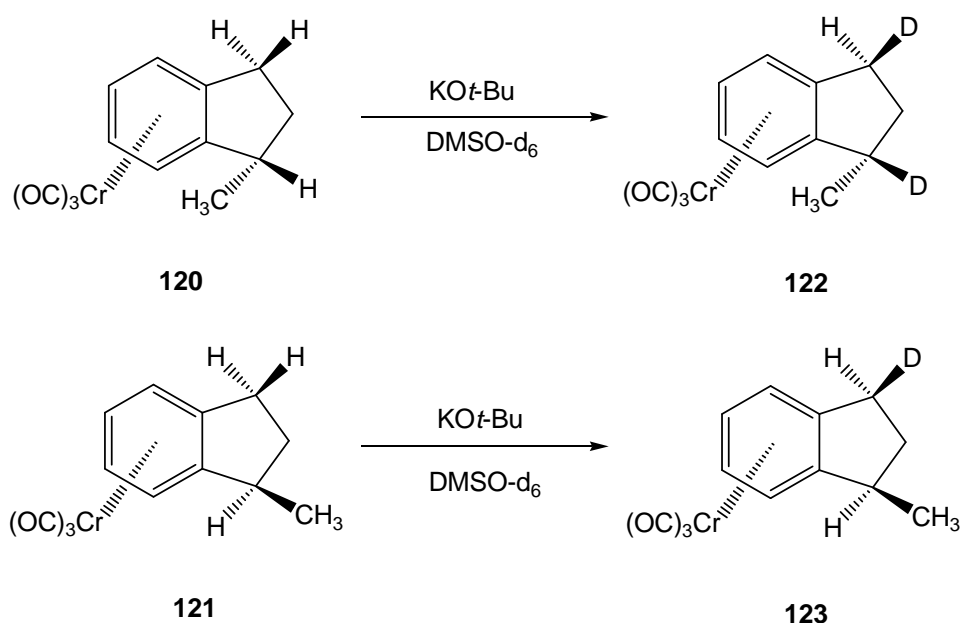

Scheme 27. The catalyzed hydrogen-deuterium exchange of complexes **120** and **121**

The functionalization reaction has been studied on both complexes **124** and **125**. Compound **124** led to complex **126** with the CH₂OH group exclusively in the 6-position on the hormone skeleton and *anti* with respect to the Cr(CO)₃ moiety. A similar regio- and stereospecificity resulted from the reaction of the β diastereomer complex **125** giving rise to complex **127** (Scheme 28).^[155]

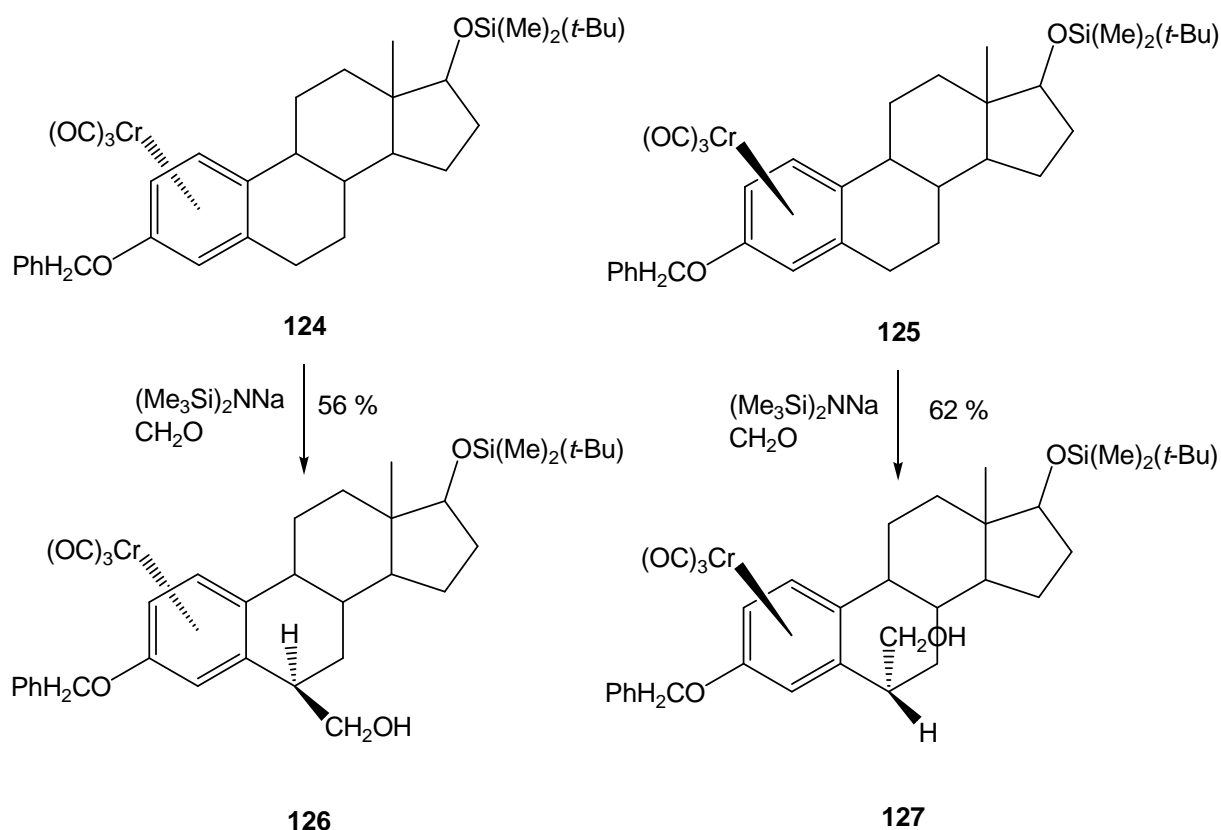

Scheme 28. Regio- and stereospecific methanolation of complexes **124** and **126**

The stereoselective synthesis of unsymmetrical *cis*-1,3-disubstituted 1,3-dihydroisobenzofurans **131** can be achieved by two sequential deprotonation-alkylation reactions of (phthalan)Cr(CO)₃ (**128**). Each of the two complexes **128** and **129** undergoes completely selective *exo*-methylation reaction (Scheme 29).^[156]

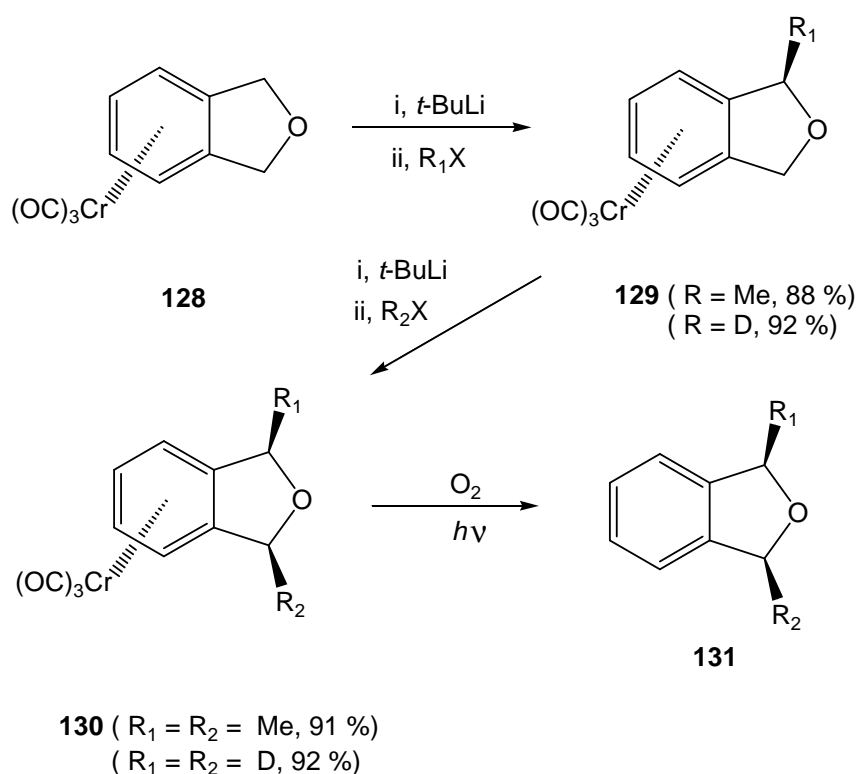

Scheme 29. Regio- and stereospecific methanolation of complexes **124** and **126**

Investigation of the nucleophilic reactions on the Cr(CO)₃ complexes of cyclic aryl ketones such as (1-tetralone)Cr(CO)₃ (**132**) show that all nucleophiles, e.g. LiAlH₄,^[157-159] NaBH₄,^[160] MeLi,^[157-159] MeMgI,^[161-162] allylMgCl,^[163] PhMgBr^[161] attack (1-tetralone)Cr(CO)₃ (**132**) from the face opposite to the Cr(CO)₃ generate the products **133** and **134** with an *endo* hydroxyl group. These types of reactions have also been performed on homochiral (1-tetralone)Cr(CO)₃ (**132**) (Scheme 30).^[164-166]

2-methyl substituents on (1-tetralone)Cr(CO)₃ do not affect the stereoselectivity even in the case of the *exo*-2-methyl derivative. All the possible 2-methylated complexes **135-137** have been studied in the homochiral series with LiAlH₄ and MeMgI as the nucleophiles.^[161] The related 2-substituted (1-tetralone)Cr(CO)₃ complexes **138** and **139** are also reduced completely stereoselectively to the corresponding *endo*-(1-tetralol)Cr(CO)₃ derivatives^[167] as are the *exo*-4-isopropyl derivatives **140**^[158] and **141**.^[159] MeLi also adds stereoselectively to **140** and **141** to give the 1-*exo*-methyl derivatives (Scheme 30).

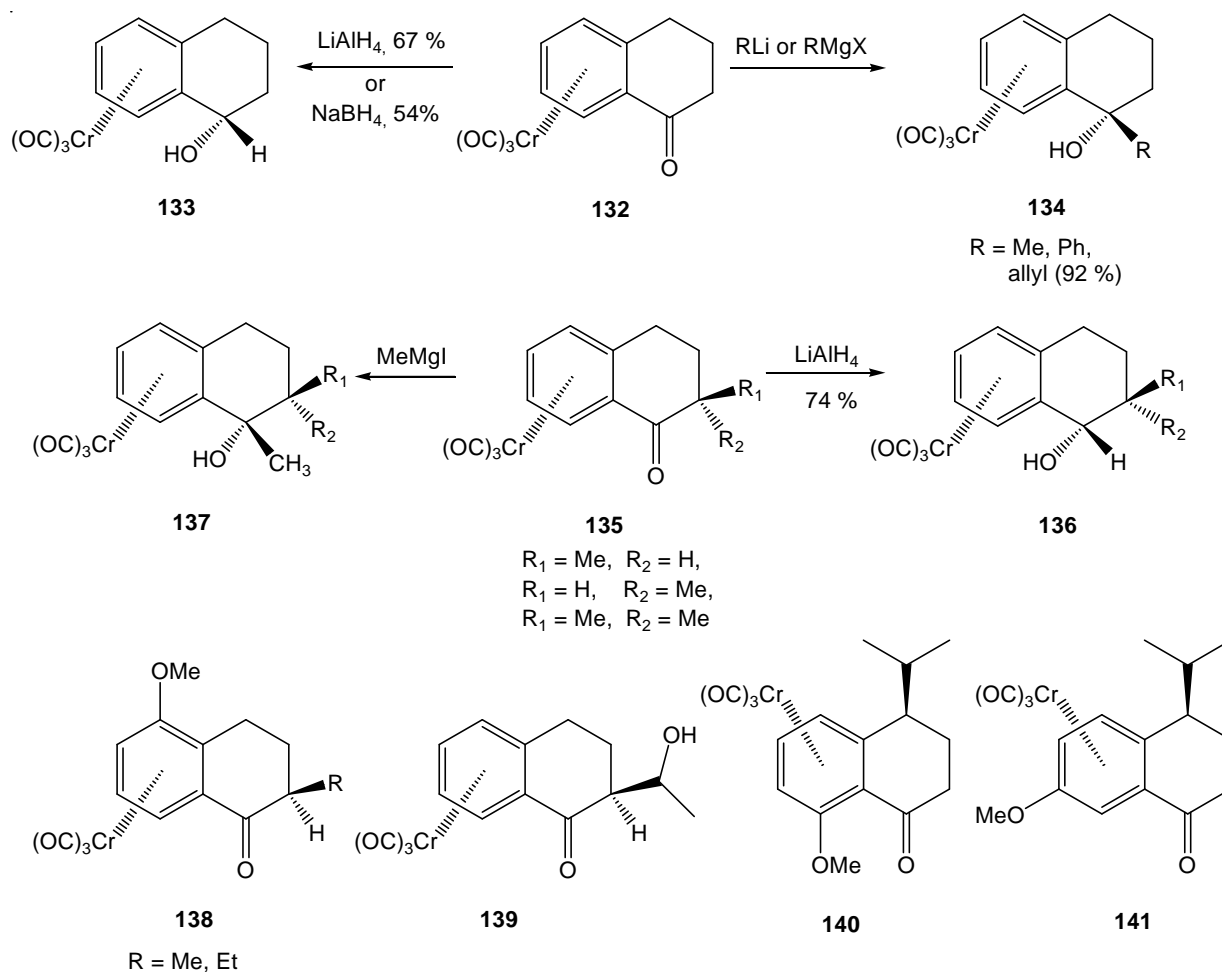

Scheme 30. Nucleophilic reactions on the (1-tetralone) Cr(CO)₃ complexes

(2-Tetralone)Cr(CO)₃ (**142**) with the carbonyl functionality further displaced from the complexed ring still shows very high stereoselectivities in addition reactions. Thus, reduction of **142** with LiAlH₄ or NaBH₄ and subsequent acetylation gave (*endo*-2-acetoxytetralin)Cr(CO)₃ **143** in 96% or 90% *de*, respectively.^[165] Also, (1-indanone)Cr(CO)₃ (**144**) in both racemic and homochiral forms undergoes *exo*-hydride reduction with LiAlH₄ or KBH₄ essentially completely stereoselectively to give *endo*-(1-indanol)Cr(CO)₃ (**145**).^[161,165] *Endo* tertiary alcohols **146** are also produced completely stereoselectively on addition of MeMgI or PhMgCl to **144** (Scheme 31).^[168]

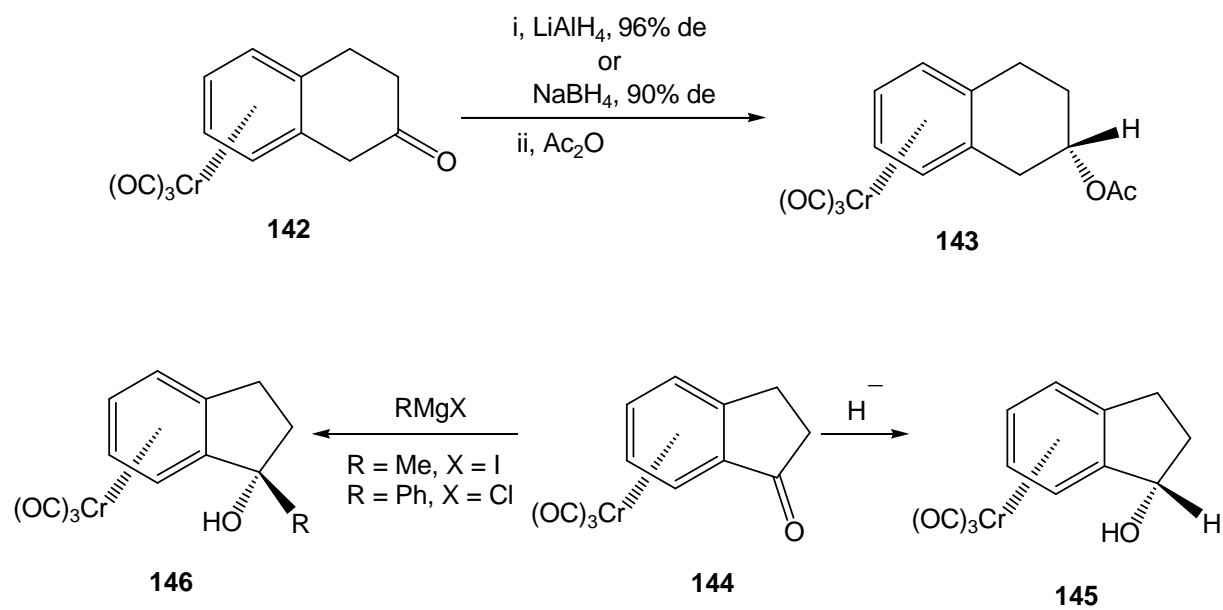

Scheme 31. Nucleophilic reactions on the (2-tetralone) $\text{Cr}(\text{CO})_3$ (**142**) and (1-Indanone) $\text{Cr}(\text{CO})_3$ (**144**)

3.2 Nucleophilic addition of methyl lithium to tricarbonyl (phthalimide) chromium(0) (72)

In the last few years our group have been involved in a programme aimed to investigate the nucleophilic addition reactions at the carbonyl group of heterocyclic chromium complexes (such as isatin and phthalimide) with different carbon nucleophiles and hydride reagent. Comparing our results with those obtained from cyclic aryl ketones such as (1-tetralone)Cr(CO)₃, (2-tetralone)Cr(CO)₃ and (1-Indanone)Cr(CO)₃, which are reacted with the above reagent stereoselectively giving only the *endo*-OH with respect to the Cr(CO)₃ moiety.^[157-168]

In conjunction of this work we investigated the addition of methyl lithium to tricarbonyl(phthalimide)chromium(0) (**72**). In this reaction 3 equiv. of MeLi solution (1.6 M in cyclohexane) was added to the cooled (-78 °C) solution of complex **72**, the colour of the mixture changing from red to yellow indicating that nucleophilic attack took place. After stirring for 3 h till TLC indicated no starting complex, hydrolysis with saturated aqueous NH₄Cl and subsequent column chromatography, product **147** was obtained in 84 % yield as a yellow solid (Scheme 32).

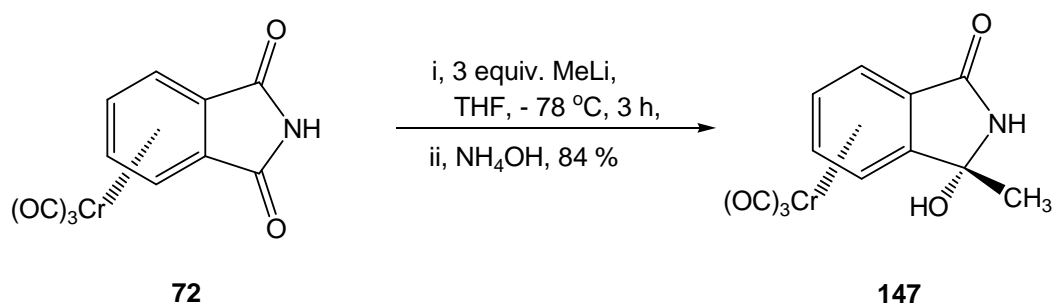

Scheme 32. Nucleophilic addition reaction of methyl lithium to tricarbonyl (phthalimide) chromium (0) (**72**)

The spectroscopic data are in agreement with the assigned structure. The IR spectrum of complex **147** shows absorption bands at $\tilde{\nu} = 3390, 3308 \text{ cm}^{-1}$ corresponding to OH and NH groups and the characteristic absorption bands at 1976 and 1885 are assigned to the Cr(CO)₃ group. In addition to the carbonyl absorption band of the amide group at 1719 cm^{-1} .

The ¹H NMR spectrum of complex **147** shows singlet signal at $\delta = 1.9 \text{ ppm}$ assigned to the methyl group, the signal of the OH group appears at $\delta = 5.5 \text{ ppm}$, and the aromatic proton

signals appears as a multiplet in region $\delta = 5.6-6.3$ ppm. In addition it indicated singlet signal at $\delta = 8.1$ ppm corresponding to the NH group

It is thought that the chemical shift of *exo* and *endo* OH group in the complexes should be different due to the shielding of the $\text{Cr}(\text{CO})_3$. The *exo*-OH should be less shielded by $\text{Cr}(\text{CO})_3$ than the *endo*-OH. Therefore, the value of chemical shift of OH will be used to confirm the configuration of the complex **147** and other complexes that will be discussed later.

The chemical shift of the OH group in complex **147** is similar to the chemical shift OH of the complexes **149-153**. Which were prepared by similar nucleophilic additions of lithium reagents to the corresponding *N*-methyl phthalimide, isatin and indandione chromium complexes (Fig. 12). The configurations of complexes **149-153** have been spectroscopically assigned as *exo*-adducts and the structure of complexes **149** and **152** have been unambiguously proven by X-ray crystallography.^[98,169]

Based on the well established rule for the nucleophilic reaction on complexes, which prove that reagents attack arene $\text{Cr}(\text{CO})_3$ complexes from the *exo* face of the ligands^[157-168] and by comparison of the chemical shift of the OH group in complex **147** with well known configuration complexes **149-153**, we can assign the complex **148** as an *exo* adduct.

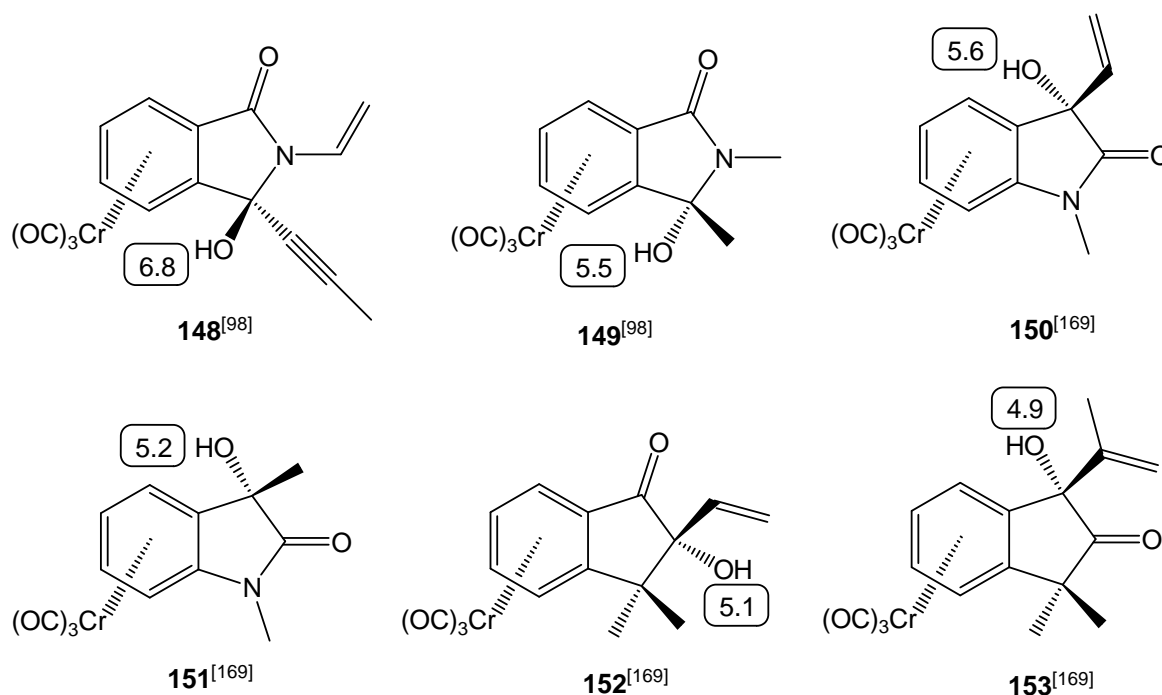
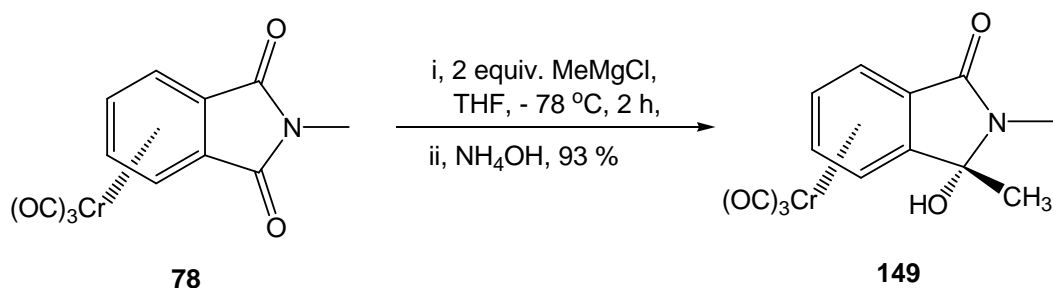

Figure. 12 ^1H NMR chemical shifts in ppm assigned for OH group

3.3 Nucleophilic addition of methyl magnesium chloride to tricarbonyl (*N*-methyl phthalimide) chromium(0) (**78**).

Tricarbonyl (3-*endo*-hydroxy-2,3-dimethyl-2,3-dihydroisindol-1-one)chromium(0) (**149**) was prepared by our group in 81 % yield using methyl lithium.^[98] We choose this compound among the reduced phthalimides complexes as precursor for the formation of tricarbonylchromium *N*-acyliminium ion, due to its stability and the high yield. We optimized the reaction condition by using methyl magnesium chloride at -78 °C for 3h to have quantitative yield of **149** (Scheme 33).



Scheme 33. Nucleophilic addition reaction of methyl magnesium chloride to complex **78**

The structure of complex **149** was confirmed based on all spectral data including X-ray single crystals which obtained by recrystallization from CH₂Cl₂/hexane (1:3) at -18 °C. The configuration of complex **149** was revealed as an *exo*-adduct by X-ray crystallography.^[98]

3.4 Reduction of tricarbonyl (*N*-methyl phthalimide) chromium (0) (**78**)

An excess of NaBH₄ (3 equiv.) was added to the cooled solution (−78 °C) of complex **78** in THF/H₂O (1:1) as solvent. The colour of the mixture changing from red to yellow indicating the reduction took place. After stirring for 30 min TLC indicated no starting material, and the reaction was quenched with HCl (1M), giving product **154** in 65 % yield as yellow solid (Scheme 34).

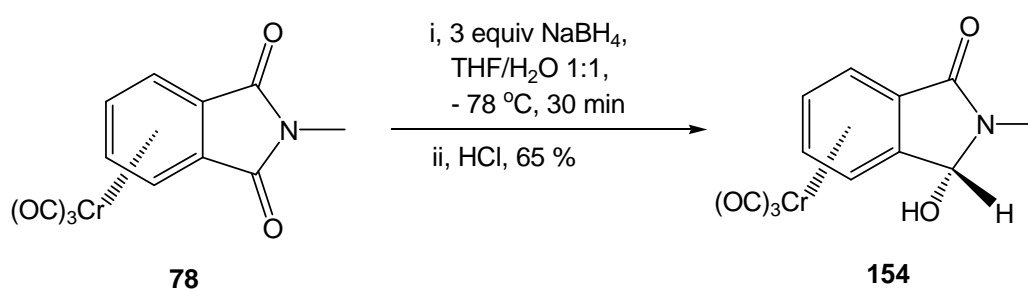

Scheme 34. Reduction of tricarbonyl (*N*-methyl phthalimide) chromium (0) (**78**)

The spectroscopic data are in agreement with the assigned structure. The IR spectrum of complex **154** shows absorption bands at $\tilde{\nu} = 3150 \text{ cm}^{-1}$ corresponding to the hydroxy group and the characteristic absorption bands of Cr(CO)₃ group at 1961, 1917, 1879. In addition to the carbonyl absorption band of the amide group at 1675 cm^{-1} . The ¹H NMR spectrum of complex **154** has singlet signal at $\delta = 2.94 \text{ ppm}$ corresponding to the methyl group, a multiplet at $\delta = 5.6 \text{ ppm}$ corresponding to two aromatic protons and a multiplet at $\delta = 5.9 \text{ ppm}$ for the benzylic hydrogen and one of the aromatic protons. The signal of OH proton appears at $\delta = 6.0 \text{ ppm}$ overlapped with one of the aromatic proton (the chemical shift of the OH group assigned the *exo* adduct). The ¹³C NMR spectrum indicated the presence of the methyl group at $\delta = 26.1 \text{ ppm}$. It also featured the aromatic CH carbon atoms up-field $\delta = 81.1\text{--}93.8 \text{ ppm}$, and the quaternary aromatic carbon atoms at 98.9, 115.5 ppm with low intensity. In addition it indicated the amide carbonyl at 165.8 ppm and the characteristic peak of Cr(CO)₃ group at 232.7 ppm. The mass spectrum shows peaks corresponding to the molecular ion, [M⁺ – 2CO], [M⁺ – 3CO], [M⁺ – 3CO – OH], [M⁺ – 3CO – H₂O], [M⁺ – Cr(CO)₃] and [Cr]⁺.

3.5 Nucleophilic Addition of methyl magnesium chloride to tricarbonyl (*N*-phenyl η^6 phthalimide) Chromium(0) (**102**)

The addition reaction of methyl magnesium chloride to tricarbonyl (*N*-phenyl η^6 phthalimide) chromium(0) (**102**) at $-78-0^\circ\text{C}$ gave product **155** in 78 % yield as yellow solid (Scheme 35).

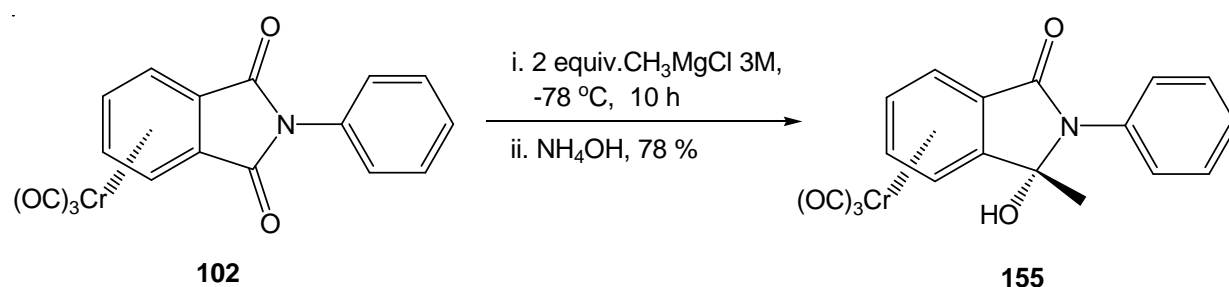

Scheme 35. Nucleophilic addition reaction of methyl magnesium chloride to complex **102**

The spectroscopic data are in agreement with the assigned structure. The IR spectrum of complex **155** shows absorption bands at $\tilde{\nu} = 3400\text{ cm}^{-1}$ corresponding to the hydroxy group and absorption bands at 1963, 1958, 1889 cm^{-1} which are assigned to the $\text{Cr}(\text{CO})_3$ group, in addition to the carbonyl absorption of the amide group at 1700 cm^{-1} . The ^1H NMR spectrum of complex **155** shows singlet signal at $\delta = 1.7$ ppm assigned to the methyl group and two sets of aromatic protons one up-field at $\delta = 5.7\text{-}6.5$ ppm corresponding to four protons of phthalimide, due to bonding with $\text{Cr}(\text{CO})_3$ group. The other five aromatic proton signals at $\delta = 7.4$ ppm are assigned to the phenyl group. The hydroxyl proton signal peak appears at $\delta = 6.1$ ppm. The ^{13}C NMR spectrum shows two set of the aromatic carbon atoms. The up-field carbon atom signals at $\delta = 85.5\text{-}95.3$ ppm and quaternary carbon atom signals at $\delta = 97.1$ and 116.5 ppm corresponding to phthalimide, which bonding with $\text{Cr}(\text{CO})_3$ group. The other aromatic carbon atoms at $\delta = 123.3\text{-}132.3$ ppm corresponding to the phenyl group. The spectrum also featured a methyl group at $\delta = 24.7$ and amide carbonyl at $\delta = 164.8$, in addition it indicated the characteristic peak at $\delta = 232.2$ ppm corresponding to $\text{Cr}(\text{CO})_3$ group. The mass spectrum do not shows peaks corresponding to the molecular ion this due to thermal instability, but shows peaks corresponding to $[\text{M}^+ - 3\text{CO} - \text{OH}]$, $[\text{M}^+ - 3\text{CO} - \text{H}_2\text{O}]$, $[\text{M}^+ - \text{Cr}(\text{CO})_3]$ $[\text{M}^+ - \text{Cr}(\text{CO})_3 - \text{OH}]$ and $[\text{Cr}]^+$.

3.6 Nucleophilic addition of methyl magnesium chloride to tricarbonyl(*N*-2-bromo ethyl phthalimide)chromium(0) (**81**)

The nucleophilic addition of methyl magnesium chloride to tricarbonyl(2-bromoethyl phthalimide) chromium(0) (**81**) at low temperature ($-78-0\text{ }^{\circ}\text{C}$) gave only one product **156**. On the other hand, when the reaction was carried out at room temperature, we obtained the tricyclic complex **157** in addition to complex **156** (Scheme 36). According to the literature, similar non-complexed tricyclic system derived from 2-bromoethyl phthalimide was obtained by heating the reaction mixture at $40\text{ }^{\circ}\text{C}$.^[170]

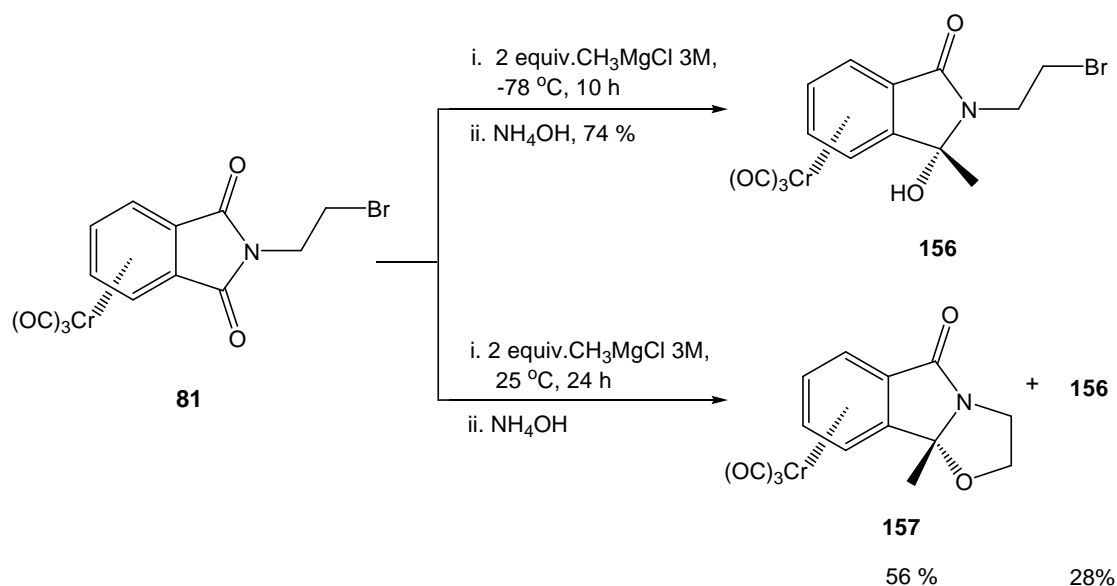

Scheme 36. Nucleophilic addition reaction of methyl magnesium chloride to complex **81**

At low temperatures ($-78-0\text{ }^{\circ}\text{C}$) the nucleophilic addition of methyl magnesium chloride to complex **81** gave the expected tricarbonyl [2-(2-Bromo-ethyl)-3-hydroxy-3-methyl-2,3-dihydro-isoindol-1-one] chromium(0) (**156**) by usual hydrolysis of the intermediate. But at higher temperature a second intramolecular nucleophilic cyclisation reaction takes place to give tricarbonyl (9b-Methyl-2,3-dihydro-9bH-oxazolo[2,3-a]isoindol-5-one) chromium(0) (**157**) (Scheme 37).

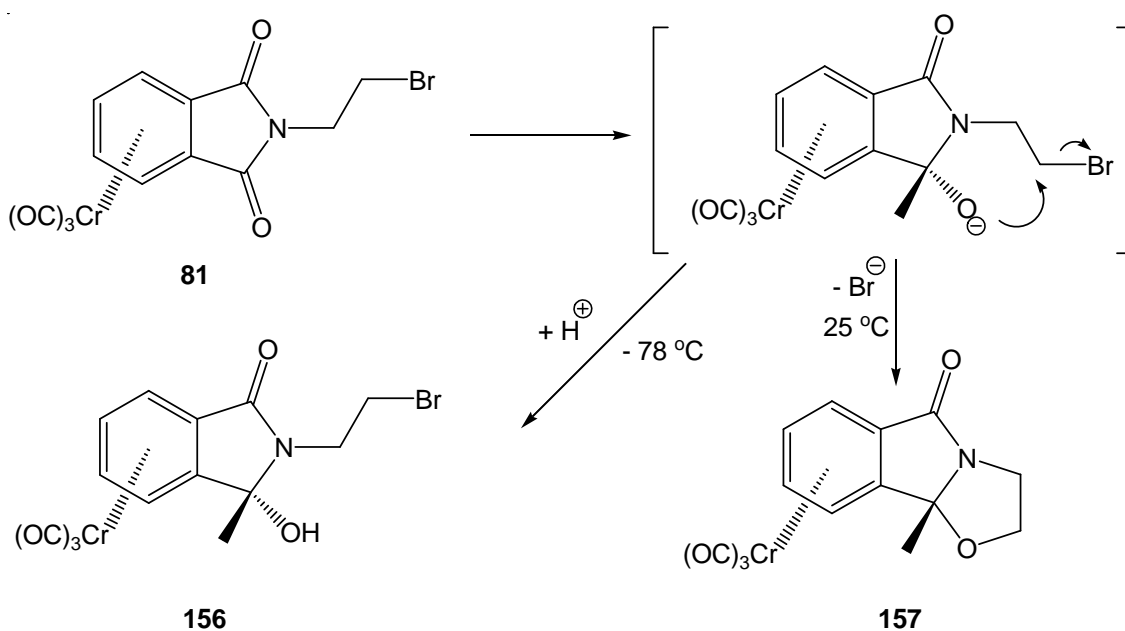

Scheme 37. Proposed path way for the formation of complexes **156** and **157**

The structures of complexes **156** and **157** were elucidated based on the different spectral tools. The IR of **156** shows the hydroxyl absorption band at $\tilde{\nu} = 3370 \text{ cm}^{-1}$, while this band disappeared in complex **157**. The ^1H NMR spectrum of **156** shows singlet signal for the methyl group at $\delta = 1.9 \text{ ppm}$, while the ^1H NMR spectrum of complex **157** shows that signal of the methyl group at similar chemical shift of complex **156** ($\delta = 1.8 \text{ ppm}$) that means there is no change in the configuration of the methyl group, which identified as *exo* to the tricarbonyl chromium group based on the chemical shift of the hydroxy group of **156** ($\delta = 5.9 \text{ ppm}$). Moreover, the ^1H NMR spectrum of **156** shows two separate triplet signals at $\delta = 3.6$ and 3.8 ppm for the two methylene groups (CH_2Br) and (CH_2N) respectively. While the ^1H NMR spectrum of **157** shows one multiplet signal at $\delta = 4.1 \text{ ppm}$ for (CH_2O) and two multiplet signals for (CH_2N), one proton at $\delta = 3.5 \text{ ppm}$ and the other proton at an unusually low-field ($\delta = 4.3 \text{ ppm}$) this due to deshielding influence of the adjacent carbonyl group.^[170-171] The ^{13}C NMR spectra show that NCH_2 signal in both **156** and **157** are similar $\delta = 41.4$ and 42.1 ppm respectively. On the other hand, CH_2Br signal of **156** appears at $\delta = 29.1 \text{ ppm}$ while CH_2O signal of **157** appear at $\delta = 68.2 \text{ ppm}$, which confirm that cyclisation took place. Finally, the mass spectra are in agreement with the molecular ion peaks of both **156** and **157** at $m/z = 407, 405$ (1:1) and 325 respectively.

3.7 Methylation of tricarbonyl(3-hydroxy-2,3-dimethyl-2,3-dihydro-isoindol-1-one) chromium(0) (**149**)

This part of work suggested to confirm the construction of the nucleophilic addition products by preparing both *exo* and *endo* isomers as in Scheme 38. Confirmation of the construction by either ^1H NMR spectrum which expected to give different chemical shift values of the methyl group due to the shielding effect of $\text{Cr}(\text{CO})_3$ group or using NOE measurement.

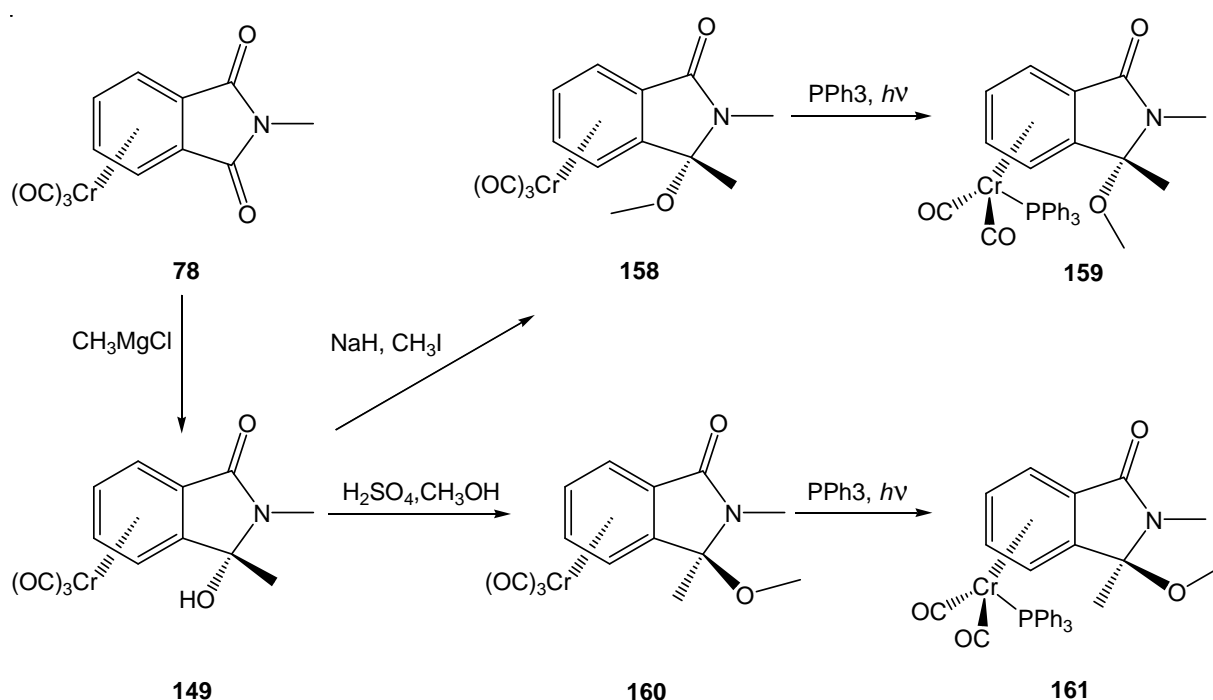

Scheme 38. Reactions of complex **149** with different reagents

The reaction of tricarbonyl(3-hydroxy-2,3-dimethyl-2,3-dihydro-isoindol-1-one)chromium(0) (**149**) with methyl iodide in the presence of NaH gave tricarbonyl (2,3-dimethyl-3-methoxy-2,3-dihydro-isoindol-1-one) chromium(0) (**158**) as a yellow solid in 73 % yield (Scheme 39).

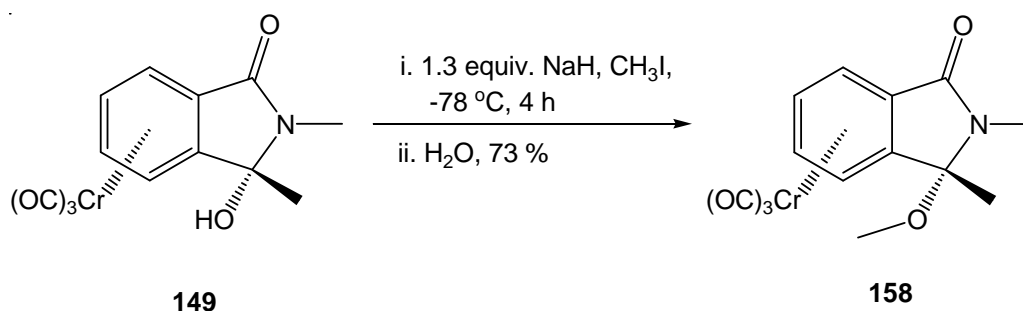

Scheme 39. Methylation of complex **149** with methyl iodide

The spectroscopic data are in agreement with the assigned structure. The IR of complex **158** shows the characteristic absorption bands for the $\text{Cr}(\text{CO})_3$ at 1957, 1892, 1863 cm^{-1} , in addition to the carbonyl absorption band of the amide group at 1709 cm^{-1} . The ^1H NMR spectrum of the complex **158** shows three singlet signals at $\delta = 1.8, 2.9$ and 2.8 ppm for two methyl groups ($\text{CCH}_3, \text{NCH}_3$) and methoxy group respectively. Moreover the aromatic protons up-field at $\delta = 5.7\text{-}6.3$ ppm. The ^{13}C NMR spectrum shows three methyl signals at $\delta = 23.8, 24.9$ and 49.8 ppm assigned to $\text{NCH}_3, \text{CCH}_3$ and OCH_3 respectively. Moreover the aromatic CH signals appears at $\delta = 85.8, 91.6, 91.8$ and 96.2 ppm, also three signals for quaternary carbon atoms appears at $\delta = 91.8, 99.1$ and 113.2 ppm. In addition, the spectrum shows signals corresponding to the amide carbonyl carbon at $\delta = 165.8$ ppm and the characteristic peak of $\text{Cr}(\text{CO})_3$ group at $\delta = 232.7$ ppm. The mass spectrum shows peaks corresponding to the molecular ion, $[\text{M}^+ - \text{CH}_3\text{O}]$, $[\text{M}^+ - \text{CH}_3\text{OH}]$, $[\text{M}^+ - 2\text{CO}]$, $[\text{M}^+ - 3\text{CO}]$, $[\text{M}^+ - 3\text{CO} - \text{CH}_3\text{O}]$, $[\text{M}^+ - \text{Cr}(\text{CO})_3 - \text{CH}_3\text{O}]$, 159 (23) $[\text{M}^+ - \text{Cr}(\text{CO})_3 - \text{CH}_3\text{OH}]$ and $[\text{Cr}]^+$.

3.8 Dehydration of tricarbonyl(3-hydroxy-2,3-dimethyl-2,3-dihydro-isoindol-1-one) chromium(0) (**149**)

Attempts to prepare the stereoisomer of complex **158** (**160**) by treatment of complex **149** with either Lewis acid ($\text{BF}_3 \cdot \text{OEt}_2$) or mineral acids (HCl or H_2SO_4) as reported for similar complexes **163**.^[172] Actually we get the dehydrated complex **162** as the main product in case of Lewis acid. While in case of mineral acids HCl or H_2SO_4 we get also decomposed materials (Scheme 40).

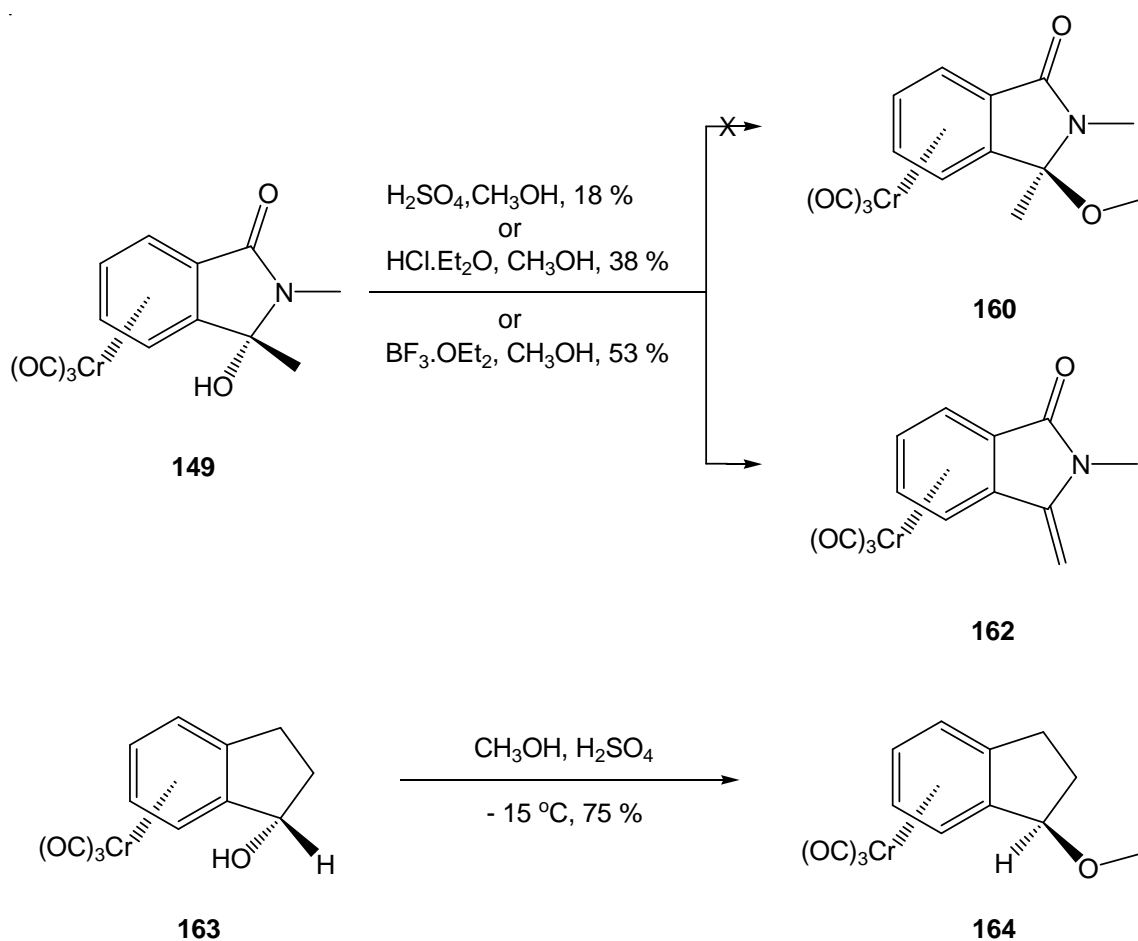

Scheme 40. Dehydration of complex **149** with different dehydrating agent

According to the reaction mechanism, the first step is the formation of the stable tricarbonylchromium *N*-acyliminium ion by dehydroxylation with different acids. This intermediate could be attacked by methanol followed by proton elimination to give the desired

complex **160**. The other possibility which took place is elimination of one hydrogen from the adjacent methyl group to give complex **162** (Scheme 41).

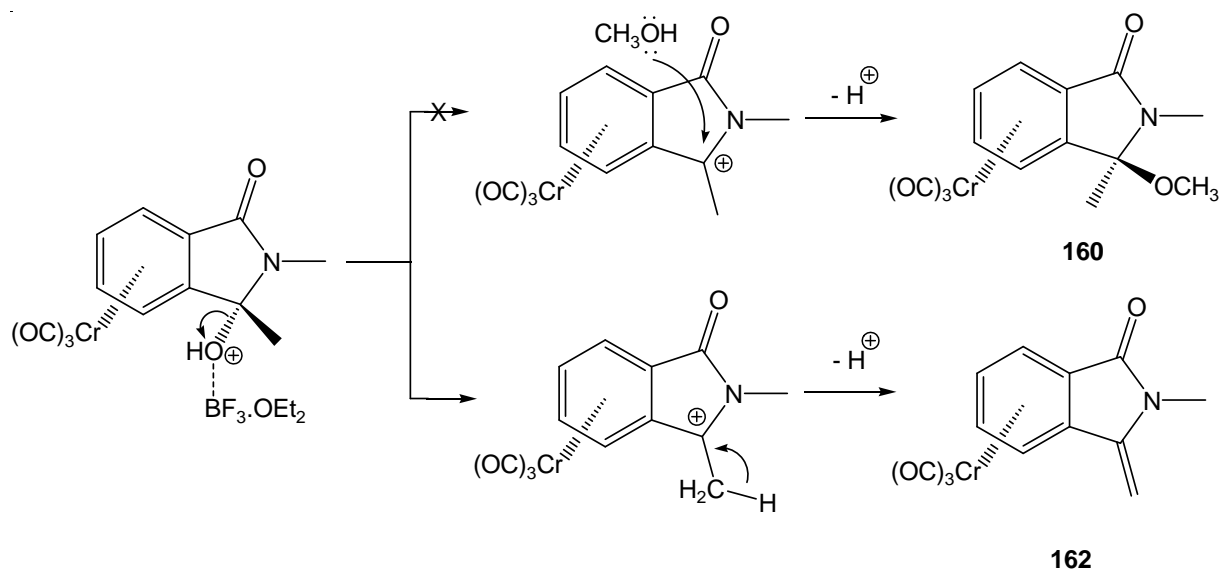

Scheme 41. The reaction mechanism of the dehydration vs. substitution of complex **149**

Wang *et al* reported that reduction of **165** (R = CH₃) by sodium cyanoborohydride in the presence of HCl in methanol, afford 3-methyl-2,3-dihydroisindol-1-one (**168**) in 94% yield via the intermediate **167**. On the other hand, compounds **165** (R = Ph) under the same conditions as those used for the preparation of **168** gave 3-phenyl-3-methoxy-2,3-dihydroisindol-1-one (**166**). From this experimental results and previous studies,^[173-175] it can be stated that the primary or secondary alkyl group at the 3-position in compounds **165** dehydrated easily into the *N*-acyliminium ion, which stabilized and coexisted with the styrene molecule, which then reduced by the hydride donor (NaCNBH₃ in methanol) to give **168**. Under the same conditions, the tertiary alkyl group at the 3-position **165** (R = Ph) underwent dehydroxylation by HCl to give a stable acyliminium ion, by resonance with benzylic carbocation, which then attacked by the solvent (methanol) to give **166**, but if an aprotic solvent such as in THF used instead of methanol, the forming acyliminium ion was subsequently reduced by NaCNBH₃ to furnish the desired compounds **168** (R = Ph) Scheme 42.

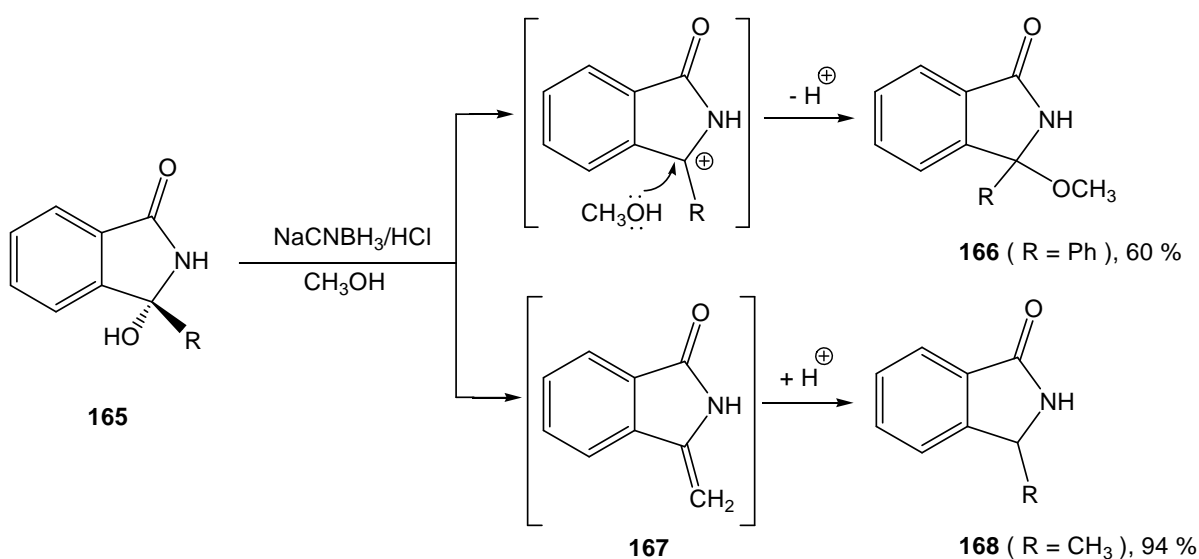

Scheme 42. The reaction mechanism of dehydration of compound **165**

The structure of complex **162** was confirmed based on elemental analysis and spectral data. The IR spectrum of the complex **162** shows the characteristic absorption bands at 1965, 1889 cm^{-1} assigned to $\text{Cr}(\text{CO})_3$, in addition to the carbonyl absorption band of the amide group at 1703 cm^{-1} . The ^1H NMR spectrum of the complex **162** shows singlet signal at $\delta = 3.2$ ppm assigned to the methyl group and the methylene protons appear as two separate doublet signals at $\delta = 4.9$, ($J = 2.5$ Hz) ppm and $\delta = 5.0$ ($J = 2.6$ Hz) ppm. In addition the aromatic proton signals $\delta = 5.3$ -6.1 ppm. The ^{13}C NMR spectrum shows the methyl signal at $\delta = 26.3$ ppm and the quaternary carbon ($\text{C}=\text{CH}_2$) signal at low magnetic field $\delta = 141.2$ ppm. Moreover, the aromatic CH signals appears at $\delta = 82.6$, 88.4, 88.8 and 93.2 ppm, also two signals for quaternary carbon atoms appears at $\delta = 90.5$ and 102.0 ppm. In addition the spectrum features signals corresponding to the amide carbonyl carbon at $\delta = 165.3$ ppm and the characteristic signal of $\text{Cr}(\text{CO})_3$ group at $\delta = 230.6$ ppm. The mass spectrum shows peaks corresponding to the molecular ion $[\text{M}^+]$, $[\text{M}^+ - 2\text{CO}]$, $[\text{M}^+ - 3\text{CO}]$, $[\text{M}^+ - \text{Cr}(\text{CO})_3]$ and $[\text{Cr}]^+$.

Single crystals for complex **162** was obtained by recrystallization from CH_2Cl_2 /hexane (1:3) at 25°C, (Fig. 13).

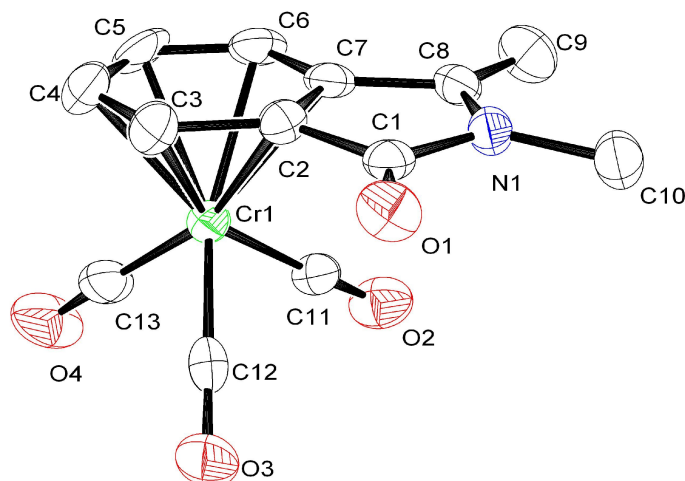

Figure 13. Structure of **162** in the crystal

Selected bond lengths [\AA] and angles [$^\circ$]

Cr1-C11 1.841(7), Cr1-C12 1.848(6), Cr1-C13 1.845(6), Cr1-C2 2.203(5), Cr1-C3 2.208(6), Cr1-C4 2.223(6), Cr1-C5 2.212(5), Cr1-C6 2.228(5), Cr1-C7 2.221(5), N1-C1 1.365(7), N1-C8 1.405(7), N1-C10 1.453(7), O1-C1 1.217(6), O2-C11 1.149(7), O3-C12 1.151(6), O4-C13 1.159(7), C1-C2 1.495(8), C3-C2 1.424(8), C3-C4 1.393(9), C4-C5 1.405(10), C6-C5 1.402(9), C7-C6 1.417(8), C7-C2 1.393(8), C7-C8 1.467(8), C8-C9 1.322(8).

C11-Cr1-C2 112.6(2), C13-Cr1-C2 158.9(3), C12-Cr1-C2 93.7(2), C7-Cr1-C6 37.1(2), C4-Cr1-C6 66.7(3), O3-C12-Cr1 178.4(5), C8-C9-H9A 120.0, C8-C9-H9B 120.0, H9A-C9-H9B 120.0.

The X-ray structure analysis data shows that all Cr-C2, Cr-C3, Cr-C4, Cr-C5, Cr-C6, Cr-C7 nearly have the same bond length about 2.21 \AA , which indicates that the coordination of the aromatic ring is centred with the chromium atom. Also all C-C bonds of the aromatic ring nearly have the same bond length about 1.40 \AA , which are identical to the C-C the free aromatic ring, which indicates that coordination of the $\text{Cr}(\text{CO})_3$ group to the aromatic ring do not affect on the resonance and C-C bond length.

3.9 Reduction of tricarbonyl(3-hydroxy-2,3-dimethyl-2,3-dihydro-isoindol-1-one) chromium (0) (**149**)

Treatment of mixture of complex **149** and triethylsilane in THF at $-78\text{ }^{\circ}\text{C}$ with $\text{BF}_3\cdot\text{OEt}_2$ gave complex **169** as yellow solid in 61 % yield, in addition to the dehydrated product **162** as orange solid in 11 % yield (Scheme 43).

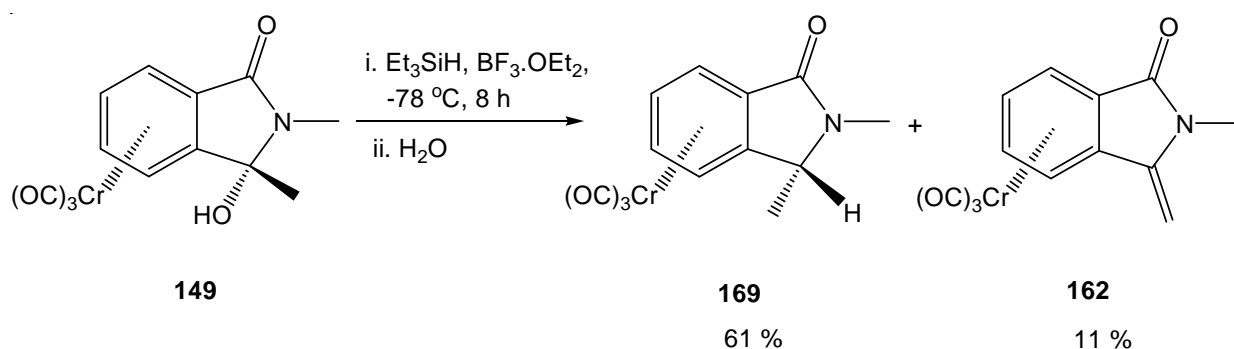

Scheme 43. The reduction of complex **149** by triethylsilane.

The formed product is expected to be an *endo*-methyl group with respect to the tricarbonylchromium. This because after dehydroxylation by Lewis acid the acyliminium ion attacked by the bulky triethylsilane from the opposite side to the tricarbonylchromium group. Therefore, the hydride set in the *exo* position according to this suggested mechanism (Scheme 44).

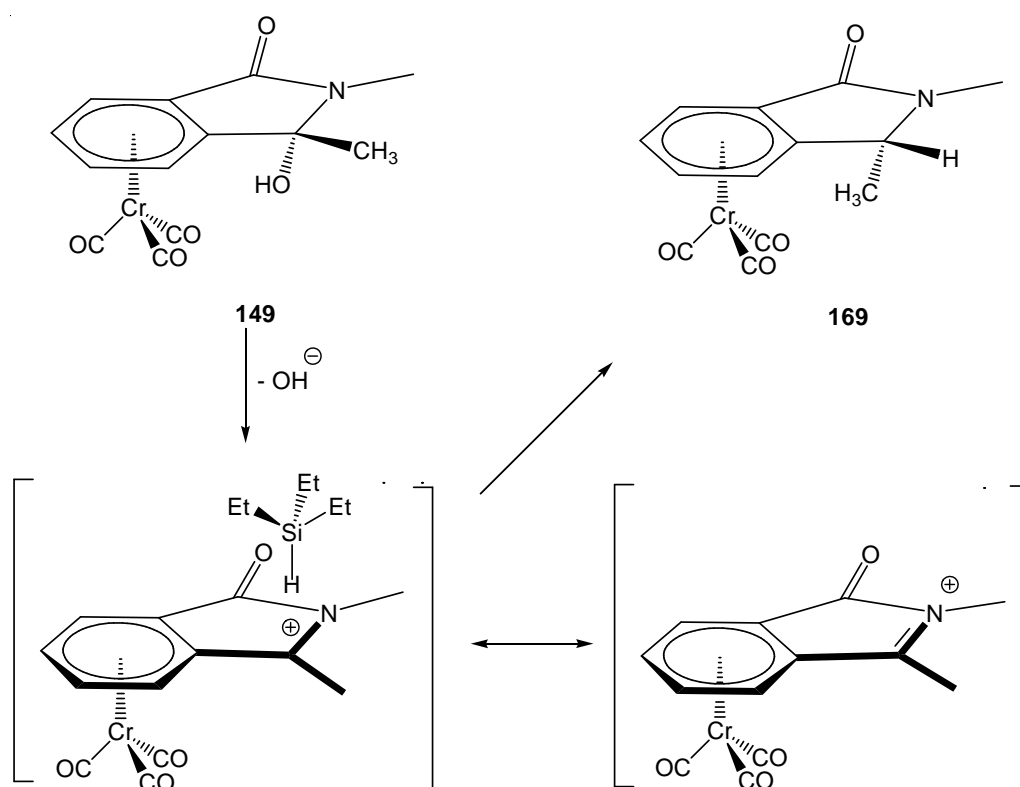

Scheme 44. The suggested mechanism of the reduction of complex **149** by triethylsilane

The spectroscopic data are in agreement with the assigned structure. The IR spectrum of complex **169** shows the characteristic absorption bands of $\text{Cr}(\text{CO})_3$ at 1964, 1871 cm^{-1} , in addition to the carbonyl absorption band of the amide group at 1688 cm^{-1} . The ^1H NMR spectrum of complex **169** shows doublet signal at $\delta = 1.6$ ppm ($J = 6.5$ Hz, 3H) corresponding to the $\text{CH}-\text{CH}_3$ group and singlet at $\delta = 3.0$ ppm corresponding to NCH_3 . The benzylic hydrogen appears as quartet signal at $\delta = 4.6$ ppm ($J = 6.1$ Hz). In addition to the aromatic protons at $\delta = 5.6$ - 6.3 ppm. The ^{13}C NMR spectrum shows two methyl signals at $\delta = 18.6$ and 26.3 ppm for $\text{CH}-\text{CH}_3$ and NCH_3 respectively, Also the quaternary benzylic carbon signal appears at $\delta = 55.9$ ppm. Moreover, the aromatic CH signals appears at $\delta = 85.4, 90.6, 91.1$ and 95.0 ppm, also two signals for quaternary carbon atoms appears at $\delta = 100.0$ and 117.3 ppm. In addition the spectrum shows signals corresponding to the amide carbonyl carbon at $\delta = 165.8$ ppm and the characteristic signal of $\text{Cr}(\text{CO})_3$ group at $\delta = 230.0$ ppm. The mass spectrum shows peaks corresponding to the molecular ion, $[\text{M}^+ - 2\text{CO}]$, $[\text{M}^+ - 3\text{CO}]$, $[\text{M}^+ - \text{Cr}(\text{CO})_3]$, 159 (23) $[\text{M}^+ - \text{Cr}(\text{CO})_3 - \text{CH}_3]$ and $[\text{Cr}]^+$.

4 Desymmetrisation of tricarbonyl *N*-substituted phthalimide chromium (0) complexes

Desymmetrisation of a *meso* starting material using a chiral reagent or catalyst provides a powerful and versatile strategy in asymmetric synthesis as the differentiation of two enantiotopic groups facilitates the formation of multiple stereocentres in a single transformation. There are two methods were reported for desymmetrisation of *meso*-imide and dicarbonyl compound. We investigated both methods in differentiation of the two symmetric carbonyls of the phthalimide complexes.

4.5 Asymmetric olefination by using a chiral phosphonoacetate

Asymmetric desymmetrisation of *meso*-compounds involving carbon-carbon bond formation is a versatile method for the production of chiral non-racemic organic molecules. Fuji *et.al* reported asymmetric Horner-Wadsworth-Emmons (HWE) olefination by utilizing a chiral phosphonate reagent (*S*)-**171** and demonstrated that the reagent differentiated the enantiotopic carbonyl groups in *meso*- α -diketone **170** to give a (+)-(Z)- enone **172** in almost optically pure form concomitant with a trace amount of a (+)-(E)-isomer **173**, the enantiomeric excess (ee) of which was considerably low (Scheme 45).^[176]

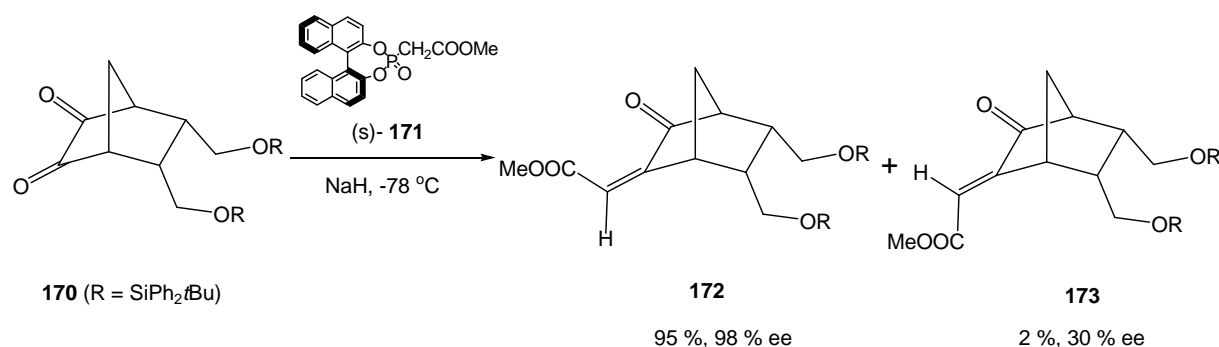

Scheme 45. HWE olefination reaction of *meso*- α -diketone **170** by using (*S*)-**171**

The chiral phosphonoacetate (*S*)-**171** can also discriminate between the enantiotopic dicarbonyls of η^6 -arene Cr and η^4 -diene Fe complexes to afford optically active olefins with planar chirality in high enantiomeric excess and good yield.^[177] Chromium complex **174** which was prepared according to Butenschön's method^[178] was treated with the anion of (*S*)-

171 at -78°C in THF for 1 h to give the *Z*-olefin **175** with 94% ee (HPLC analysis on a chiral column) in 61% yield, together with the minor *E*-isomer **176** in 29% yield whose ee was as high as 30% (Scheme 46).

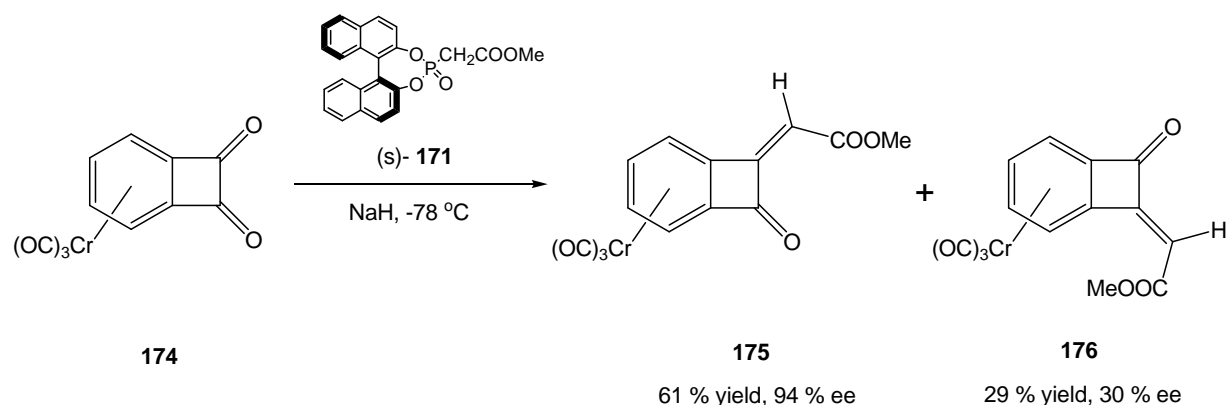

Scheme 46. HWE olefination reaction of chromium complex **174** by using (S)-**171**

The above work encouraged us to differentiate the two enantiotopic carbonyls of η^6 -phthalimide chromium complexes. Tricarbonyl(*N*-methylphthalimide)chromium(0) (**78**) was treated with the anion of (S)-**171** at -78°C in THF for 24 h. Unfortunately we got only the starting complex **78** and no formation of the desired compounds **177** and/or **178** (Scheme 47). We repeated the experiment several times at higher temperatures -78°C to 50°C but no reaction takes place. The reason may be the less reactivity of our imide towards this stabilised chiral phosphonoacetate reagent compared with the reactivity of the α -diketone **170** and **174**.

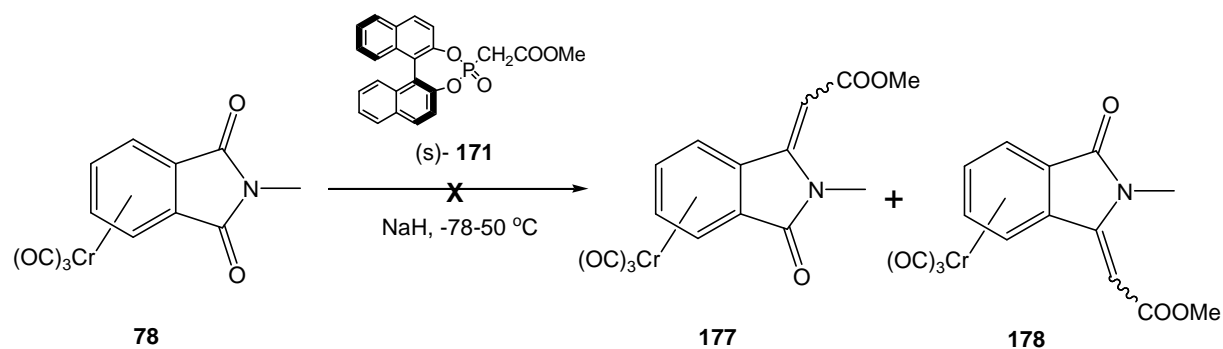

Scheme 47. HWE olefination reaction of chromium complex **78** by using (S)-**171**

4.5 Asymmetric reduction by using a chiral oxazaborolidine catalyst

Asymmetric catalysis is perhaps one of the most useful methods available to the modern organic chemist, allowing the transformation of an achiral material into an enantioenriched one.^[179] Chiral catalysts have been developed for use in various types of organic transformations, one of the most successful reactions is based on the use of 1,3,2-oxazaborolidines as chiral inductor in the asymmetric reduction of prochiral ketones. Chiral 1,3,2-oxazaborolidines **179** and **180** are generated from chiral 1,2-aminoalcohols and borane as was first reported by Itsuno *et al* (Fig. 14).^[180] then championed by Corey *et al*.^[181] soon thereafter prepared an oxazaborolidine derived from α,α -diphenyl-2-pyrrolidinemethanol **181** which was employed in the reduction of prochiral ketones with borane (BH₃-THF, CBS-method). Oxazaborolidines have also been employed in the kinetic resolution of racemic esters giving enantioenriched products.^[182] In recent years there have been several reports of the use of asymmetric reducing agents in the desymmetrisation of *meso*-imides including optically active BINAL-H^[183] and thiazazincolidine^[184] complexes. Of particular interest is the use of oxazaborolidines demonstrating that unsubstituted oxazaborolidines **180** (R = Me, OMe) were the most efficient catalysts for this transformation.^[185]

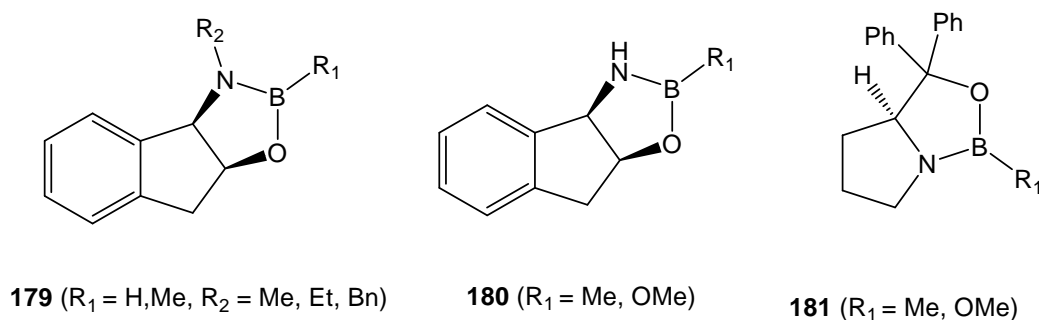
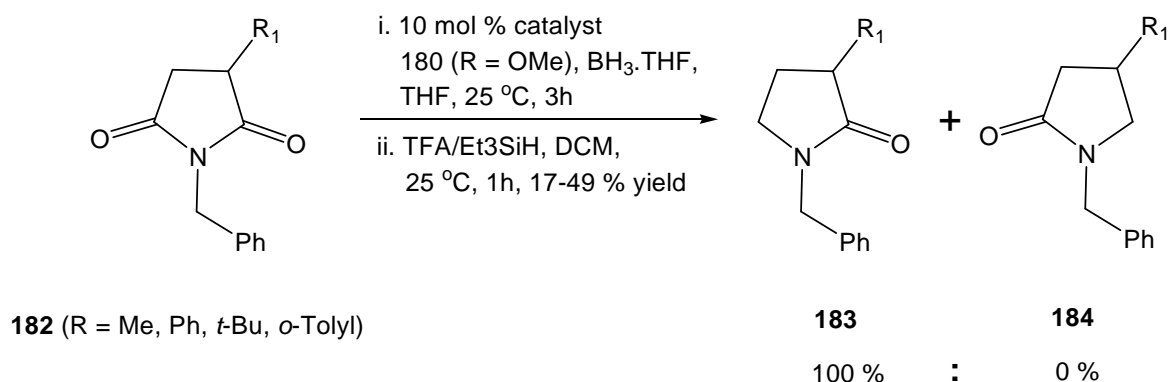

Figure 14. 1,3,2-Oxazaborolidines catalysts **179**, **180** and **181**

Speckamp and co-workers showed that regioselectivity in the reduction of imide species is controlled by the size and electronic nature of the substituent at the C-3 position when nucleophilic hydride sources are employed as the reducing agent.^[186,187] The major isomer formed in many cases was the hydroxylactam where reduction had occurred at the C-2 carbonyl, i.e. proximal to the bulky group. Since oxazaborolidine catalysts function by pre-

complexation followed by intramolecular hydride delivery. Oxazaborolidine **180** (R = OMe) was employed as the catalyst with $\text{BH}_3\cdot\text{THF}$ as the hydride source, followed by reduction of the initially formed hydroxylactam product to the corresponding γ -lactam for ease of analysis. In all cases, full regiocontrol of the reaction was achieved, reducing only the carbonyl at the C-5 position providing **183** (Scheme 48).^[188]



Scheme 48. Regioselective reduction of various C-3 substituted pyrrolidine-2,5-diones **182**

Jones *et.al.* optimised the reduction conditions of hexahydrophthalimide **185** using different chiral reducing catalysts **179-181**. they found treated with 10 mol% of catalyst **180** (R = Me) and 1 equiv. of $\text{BH}_3\cdot\text{THF}$ at 0°C for 2 h to yield a mixture of the optically active *cis*- and *trans*-5-hydroxy-2-pyrrolidinones **186** (Scheme 49). In order to simplify analysis, the crude mixture was treated with TFA and Et_3SiH and the lactam **187** isolated as the sole product in 75 % yield and the enantiomeric excess. of lactam **187** was established to be 86% by HPLC.^[189]

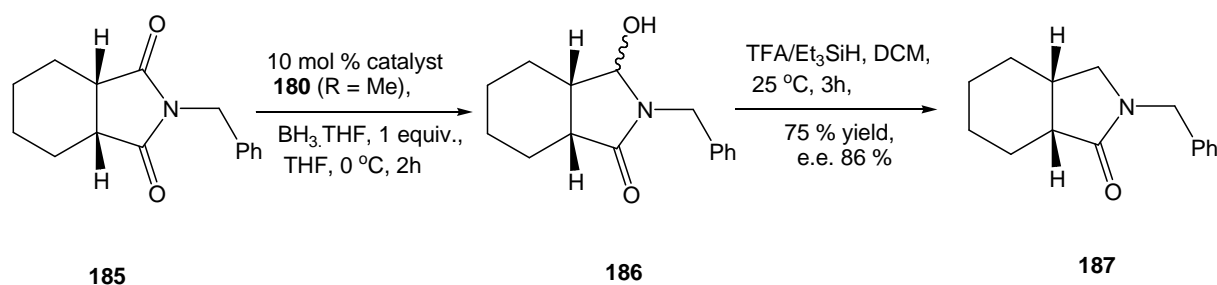

Scheme 49. Chiral reduction of hexahydrophthalimide **185**

4.5 Asymmetric reduction tricarbonyl *N*-substituted phthalimide chromium (0) by using chiral oxazaborolidine catalyst

Treatment of tricarbonyl phthalimides chromium complexes **78** and **79** with 10 mol% oxazaborolidine catalysts **180** (R = Me) and 1 equiv. of BH₃·THF at 25°C for 30 min gave the optically active tricarbonyl(3-hydroxy-2-methyl-2,3-dihydro-isoindol-1-one)chromium(0) (**188**) ([α]_D²⁵ = + 270) and tricarbonyl(3-hydroxy-2-ethyl-2,3-dihydro-isoindol-1-one)chromium (0) (**189**) respectively (Scheme 50).

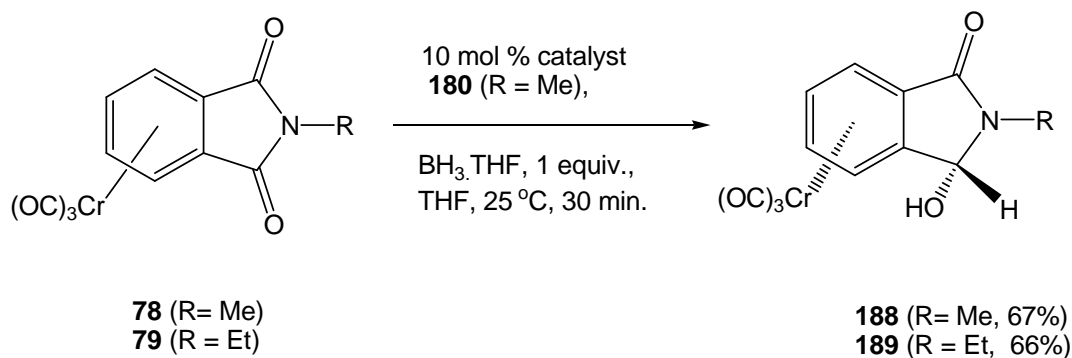

Scheme 50. Chiral reduction of tricarbonyl phthalimides chromium complexes **78** and **79**

Firstly a pre-equilibrium involving coordination of borane on the least hindered *exo*-face of the aminoindanol in readiness for delivery to the complexed carbonyl group. This equilibrium is a reversible process indicated by an equilibrium constant, $K=220$, for prolinol oxazaborolidines **181**.^[190] As the size of the substituent on the nitrogen atom is increased, steric interactions now result in the equilibrium favouring placement of the larger alkyl group on the least hindered *exo*-face, with the borane coordinating to the *endo*-face of the amino indanol. Then reduction takes place from either of these two complexes. In the case of the *exo*-borane species, delivery of hydride occurs to the coordinated carbonyl of the substrate that is orientated such that the benzylic imide is regarded as the large group occupying a position away from the *B*-methyl group. The same model applies to the *endo*-borane complex except that the opposite enantiomer of product is now produced (Scheme 51).^[189]

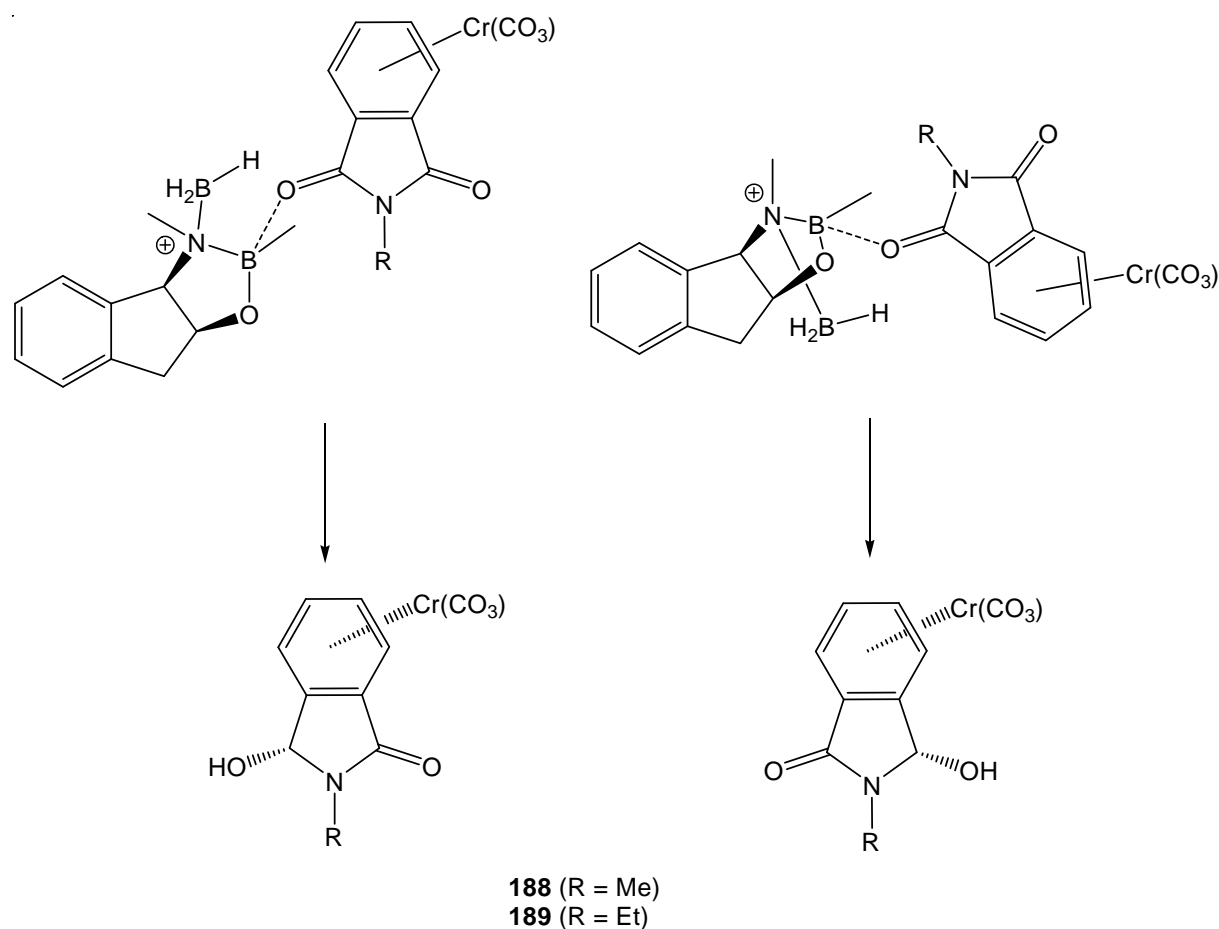
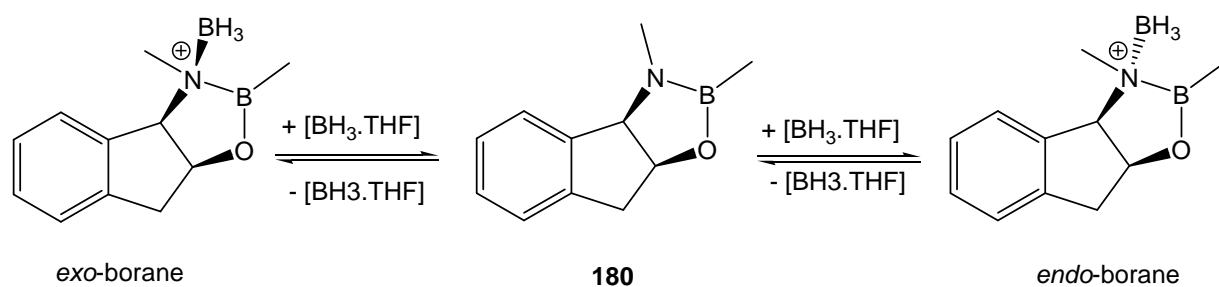

Scheme 51. proposed model for observed enantioselectivities

The spectroscopic data are in agreement with the assigned structures. The IR spectra of the complexes **188** and **189** show absorption bands corresponding to the hydroxyl group at $\tilde{\nu} = 3310$ and 3350 cm^{-1} respectively. Also the characteristic absorption bands of $\text{Cr}(\text{CO})_3$ appears at (1961, 1917, 1879) and (1964, 1912, 1868) cm^{-1} respectively. in addition to the carbonyl

absorption of the amide group at $\tilde{\nu} = 1675$ and 1679 cm^{-1} respectively. The ^1H NMR spectrum of complex **188** shows singlet signal at $\delta = 2.9$ ppm corresponding to the methyl group, two multiplet signals at $\delta = 5.6$ and 5.9 ppm corresponding to three aromatic protons and benzylic hydrogen. The OH signal of complex **188** appears at $\delta = 6.0$ ppm overlapped with one of the aromatic protons.

The ^1H NMR spectrum of complex **189** shows triplet signal at $\delta = 1.2$ ppm corresponding to the methyl group, and two multiplet signals at $\delta = 3.4$ and 3.6 ppm for the methylene group. In addition to the four aromatic protons and OH proton at $\delta = 5.6$ - 6.0 ppm. ^{13}C NMR spectrum of complex **188** shows peaks at $\delta = 26.1$ ppm corresponding to the methyl group. Moreover, the aromatic CH carbon atom signals appear in region 81.1 - 93.8 ppm and quaternary aromatic carbon atom signals appears at $\delta = 98.9$ and 115.5 ppm. In addition, the spectrum features signals corresponding to the amide carbonyl carbon at $\delta = 165.8$ ppm and a characteristic signal of $\text{Cr}(\text{CO})_3$ group at $\delta = 232.7$ ppm.

^{13}C NMR spectrum of **189** shows peaks at $\delta = 12.9$ ppm corresponding to the methyl group, and signal at $\delta = 34.0$ ppm corresponding to the methylene carbon and at $\delta = 78.8$ ppm corresponding to the benzyl carbon. In addition it indicated the aromatic CH carbon atom signals in region $\delta = 86.1$ - 93.1 ppm. Quaternary aromatic carbon signals appears at $\delta = 98.3$ and 114.8 ppm. In addition to the amide carbonyl at $\delta = 164.9$ and the characteristic peak of $\text{Cr}(\text{CO})_3$ group at $\delta = 232.1$ ppm. The mass spectrum of both **188** and **189** show peaks corresponding to the molecular ion, $[\text{M}^+ - 2\text{CO}]$, $[\text{M}^+ - 3\text{CO}]$, $[\text{M}^+ - 3\text{CO} - \text{OH}]$, $[\text{M}^+ - 3\text{CO} - \text{H}_2\text{O}]$, $[\text{M}^+ - \text{Cr}(\text{CO})_3]$ and $[\text{Cr}]^+$.

4.5 Determination of Enantiomeric Excess of (+)-93 Using Mosher's reagent

In early 1969 Mosher *et al.* established their method for the determination of enantiomeric composition and absolute configuration of alcohol and amines.^[191-193] This method includes preparation of diastereomeric esters and amides from enantiomerically pure Mosher reagents, such as α -methoxy- α -(trifluoromethyl)-phenylacetic acid (*R*)-MTPA (**190**) and (*S*)-MTPA (**191**) or α -methoxy- α -(trifluoromethyl)phenylacetate chloride (*S*)-MTPA-Cl (**192**) and (*R*)-MTPA-Cl (**193**) (Fig. 15). By measuring the intensities of the significantly different NMR signals of the diastereometrically substituted groups of ester and amides the enantiomeric excess of alcohols and amines can be determined.

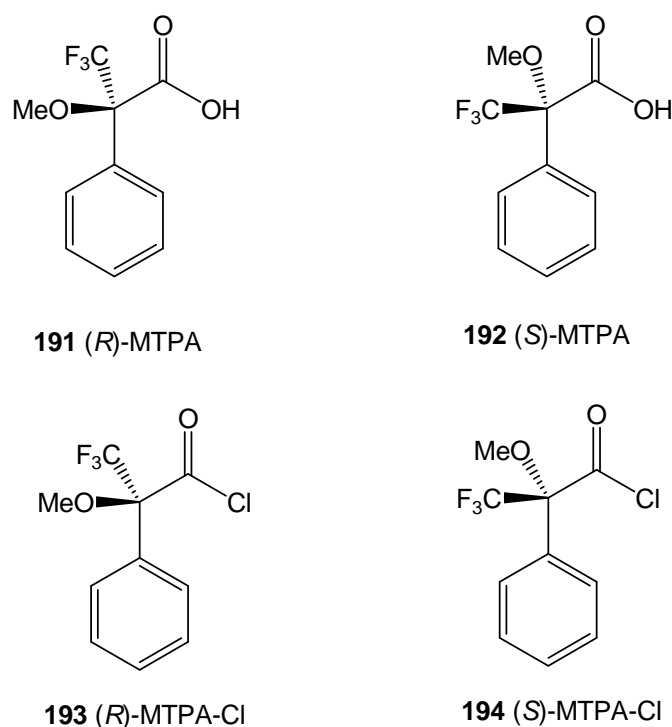

Figure 15. (*R*)-MTPA (**190**), (*S*)-MTPA (**191**), (*S*)-MTPA-Cl (**192**) and (*R*)-MTPA-Cl (**193**)

Mosher proposed that, in solution, the carbonyl proton and ester carbonyl and trifluoromethyl groups of the MTPA moiety preferentially lie in the same plane (Figure 16 A).^[192] When the MTPA group is in the hypothesized conformation, Mosher pointed out that the ¹H NMR signal of L² of the (*R*)-MTPA ester will appear upfield relative to that of the (*S*)-MTPA ester due to the diamagnetic effect of the benzene ring. The basic concept of the modified method

is essentially the same as Mosher proposed: The idealized conformation is depicted in Figure 11B. Due to the diamagnetic effect of the benzene ring the ^1H NMR signal of $\text{H}_{\text{A,B,C}}$ of the (*R*)-MTPA ester will appear upfield relative to those of the (*S*)-MTPA ester. The reverse should hold true for $\text{H}_{\text{X,Y,Z}}$. Therefore, if it is defined $\Delta\delta = \delta_{\text{S}} - \delta_{\text{R}}$, when the protons $\text{H}_{\text{A,B,C}}\dots$ on the right side of the plane, $\Delta\delta$ is positive ($\Delta\delta > 0$), when the proton $\text{H}_{\text{X,Y,Z}}\dots$ on the left side of the plane, $\Delta\delta$ is negative ($\Delta\delta < 0$). Put the protons with positive $\Delta\delta$ on the right side and those with negative $\Delta\delta$ on the left side of the model A as illustrated in Figure 16C.

Mosher's method has been most frequently used for determination of enantiomeric excess and the absolute configuration of organic compounds^[194] including tricarbonylchromium complexes.^[195]

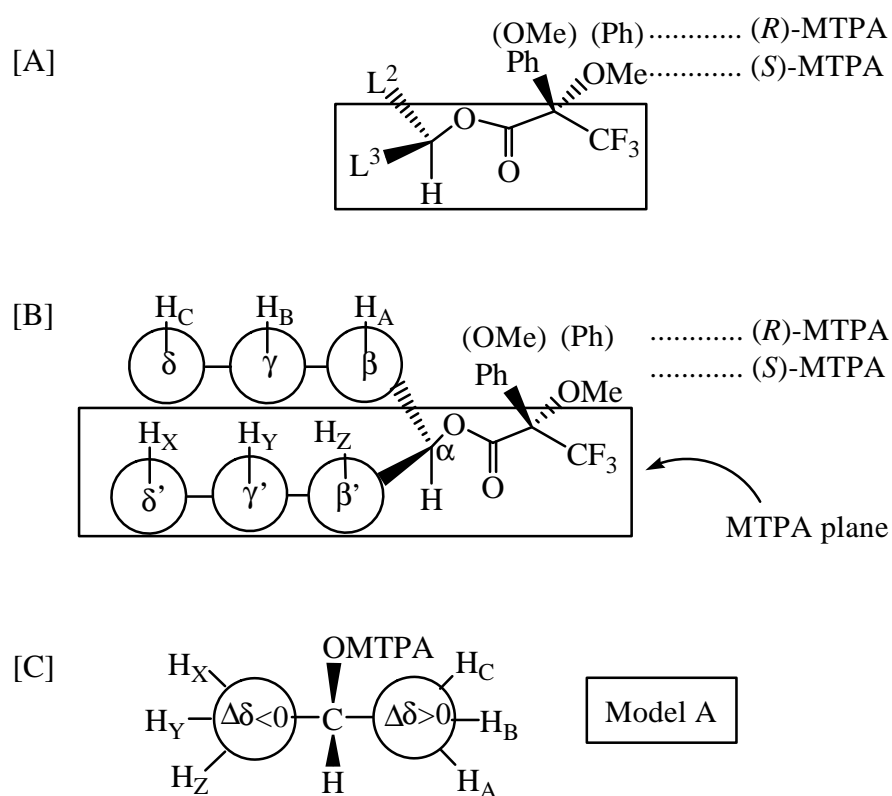
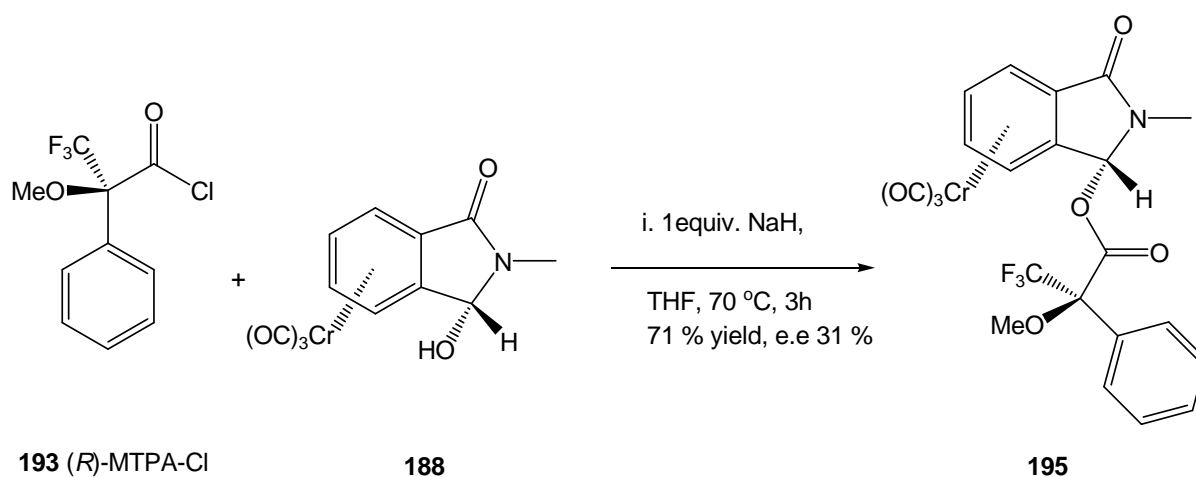

Figure 16 [A] Configuration correlation model for the (*R*)-MTPA derivatives and the (*S*)-MTPA derivatives proposed by Mosher. [B] MTPA plane of an MTPA ester. [C] Model A to determine the absolute configurations of the secondary alcohols.

Because the complete assignment of protons of complex organic molecules was practically impossible, modifications have been used upon the basic concept as Mosher proposed.^[193] The most important factor of the modified methods is the difference in steric bulkiness of the substituents on the β - and β' -carbons (Figure 16B); the steric repulsion between the phenyl group of the MTPA moiety and the β -substituents is essential to bring out the chemical shift difference of the CF_3 (^{19}F) or OMe (^1H) group. The application of Mosher's method by use of high-field FT NMR spectroscopy has been reported.^[194] This method enables one to examine the chemical shift differences of as many protons as can be assigned by means of up to date NMR techniques. It is more reliable for the prediction of the absolute configurations of complex molecules, especially natural products.

4.5 Synthesis of (R)-MTPA Ester of tricarbonyl(3-hydroxy-2-methyl-2,3-dihydro-isoindol-1-one) chromium(0) (**189**)

complex **188** dissolved in THF and an equivalent amount of NaH was added and stirred for few minutes, then (*R*)-MTPA-Cl **193** was added and the reaction mixture was heated at reflux for three hours. Mosher ester **195** is accessible in good yield (Scheme 52).



Scheme 52. synthesis of Mosher ester **195**

The isomeric products were not separable under the conditions of column chromatography and the distereomeric ratio was deduced from the intergration of peaks in ^1H NMR spectrum. The complexed aromatic ring proton peaks are almost overlapping, thus the intergration of two singlets at $\delta = 3.62$ and $\delta = 3.56$ ppm for OCH_3 groups of two diastereoisomers were used for calculation of the enantiomeric excess and revealed that complex **193** was obtained in about 31% *ee*.

C Summary

It is well established that planar-chiral arene tricarbonylchromium complexes represent highly valuable building blocks for the diastereo- and enantioselective synthesis of complex compounds. In principle, the powerful electron withdrawing effect of the $\text{Cr}(\text{CO})_3$ group might dramatically facilitate the nucleophilic attack at the amide group of the phthalimide. Moreover, it is possible to induce stereoselectivity of chemical reactions of tricarbonylchromium phthalimide complexes with respect to the “stereodirecting” effect of the $\text{Cr}(\text{CO})_3$ group. With this background, it is of considerable interest to exploit the chemical and stereochemical reaction potential of tricarbonylchromium phthalimide complexes for the synthesis of nitrogen containing heterocycles.

The present work is planned to synthesize tricarbonyl(phthalimide)chromium(0) complexes to investigate the nucleophilic addition reactions at the carbonyl group with different carbon nucleophiles and hydride reagent. For this purpose tricarbonyl(phthalimide)-chromium(0) (**72**) and its *N*-substituted derivatives **78-81**, were obtained by direct complexation of the corresponding free ligands with hexacarbonylchromium in $\text{Bu}_2\text{O}/\text{THF}$ 10:1 at 120 °C for 17-35 h in 11-61 % yields.

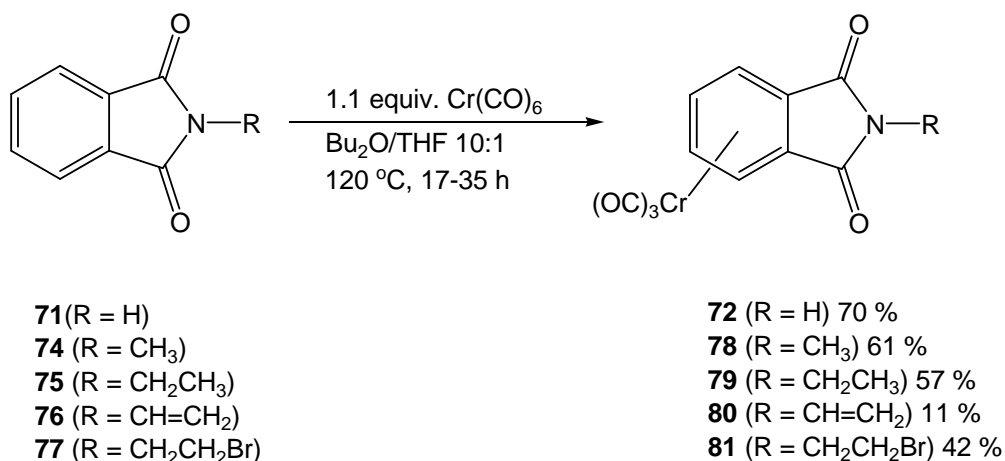

Trials to improve the yield of *N*-vinylphthalimide complex **80**, another synthetic pathways have been suggested. Firstly, Complex **72** was converted into its potassium salt **82** and heated at reflux in dimethylacetamide with vinyl bromide utilizing the method common for the free ligand but the complex **82** decomposed. Moreover, palladium catalytic vinylation of

phthalimide complex **72** also did not succeed. Finally, we could manage to improve the yield to 44 % through complexation of *N*-vinylphthalimide with Kündig's complexation reagent (tricarbonylchromium naphthalene).

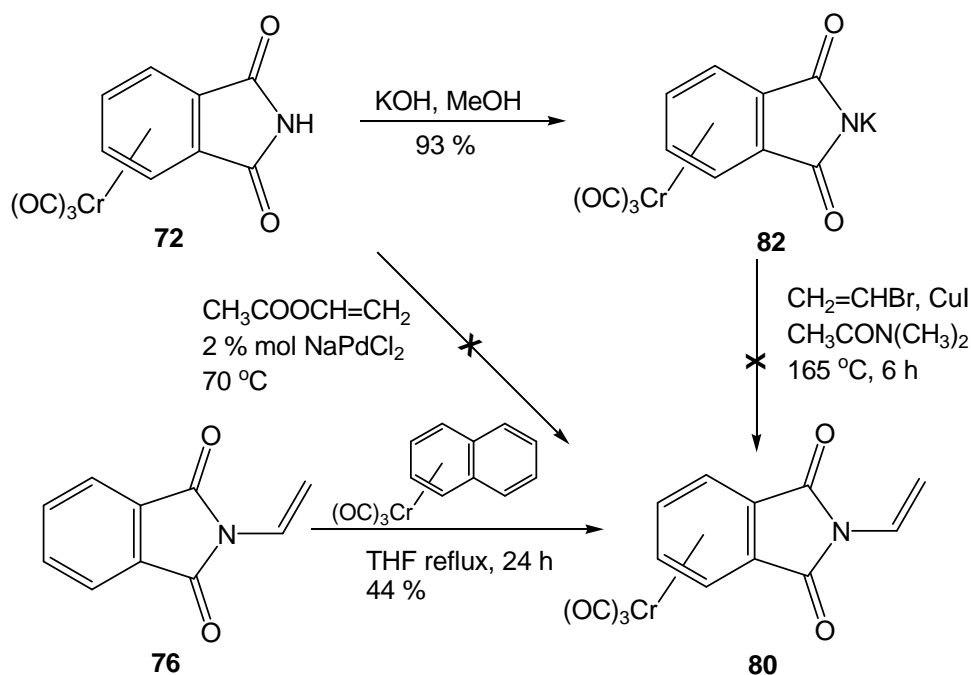

Complexation reaction of *N*-phenyl phthalimide (**100**) can afford one, two or three complexes **101-103**, because $Cr(CO)_3$ group can be coordinated with either or both of the benzene ring of phthalimide and aryl groups. Actually we separated and identified both complexes **101** and **102** in 31 % and 11 % respectively.

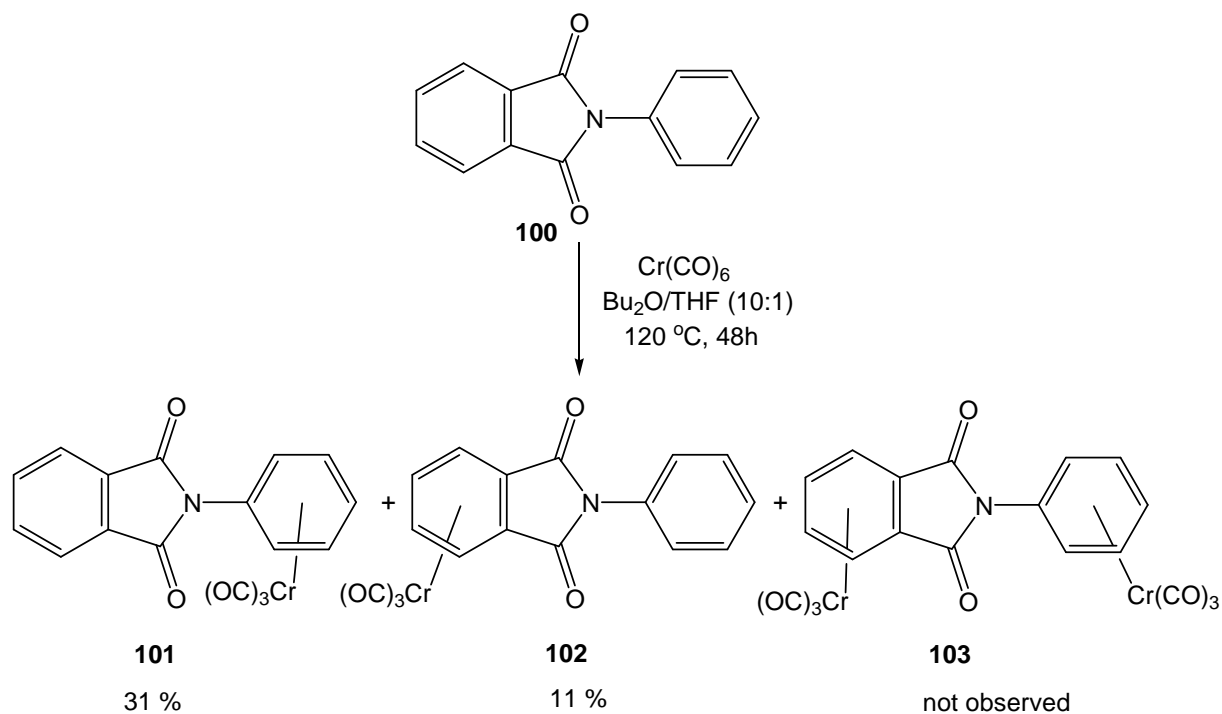

A series of mixed ligand complexes of the general type (phthalimide) $\text{Cr(CO)}_2(\text{PPh}_3)$ has been prepared photochemically. Triphenylphosphine (2 equiv.) was added to a solution of the tricarbonyl(phthalimide)chromium complexes **72**, **78**, **79** (1 equiv.) in toluene (30 mL). The reaction mixture was then irradiated for 30 min to 3 h. with a 125 W mercury lamp using a quartz cell.

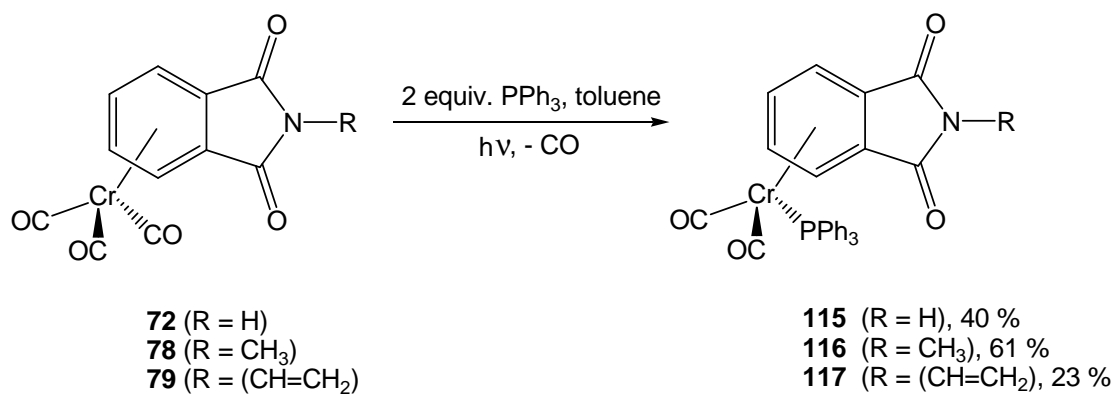

Also, dicarbonyl phosphine/phosphite complexes **118** and **119** were prepared by irradiating mixture of tricarbonyl(*N*-methyl phthalimide)chromium complex (**78**) with trimethyl phosphine or triethyl phosphite, respectively.

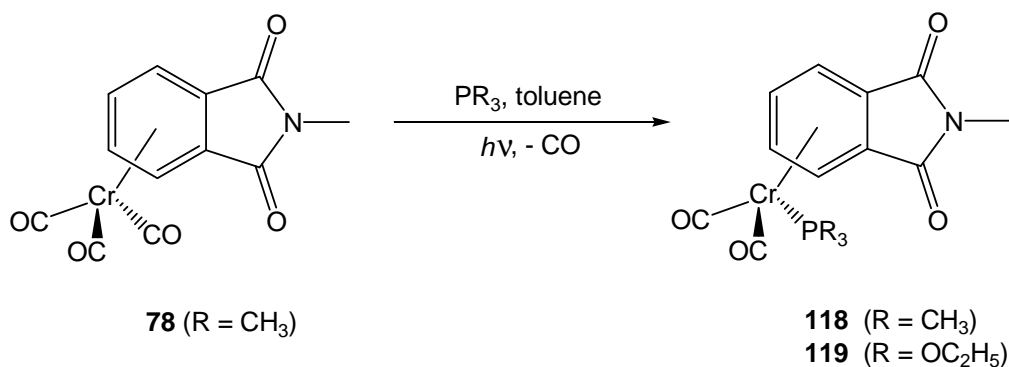

Nucleophilic addition reactions of methyllithium, methyl magnesium chloride and sodium borohydride to tricarbonyl(*N*-methyl phthalimide)chromium complexes were taken place with high yield giving only the *endo* isomer, which assigned by the chemical shift of the hydroxyl group.

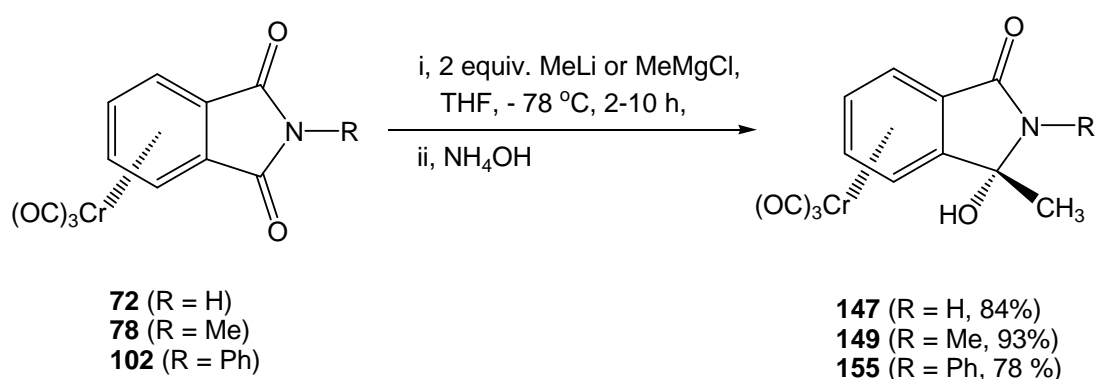

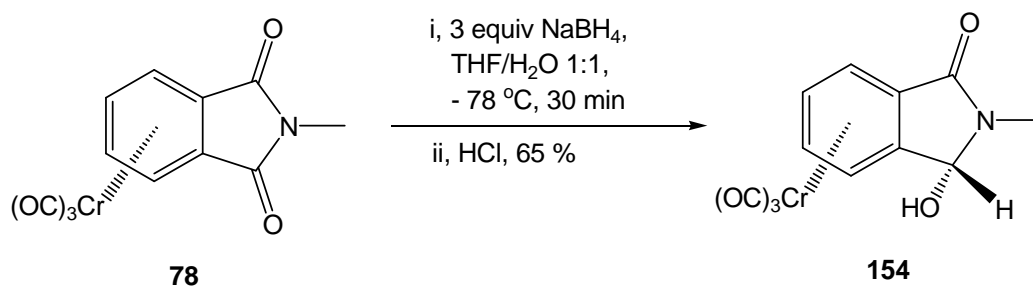

The nucleophilic addition of methyl magnesium chloride to tricarboxyl(2-bromoethyl phthalimide) Chromium(0) (**81**) at low temperature (-78°C) gave only one product **156**.

On the other hand, when the reaction was carried out at room temperature, we obtained the tricyclic complex **157** in addition to complex **156**

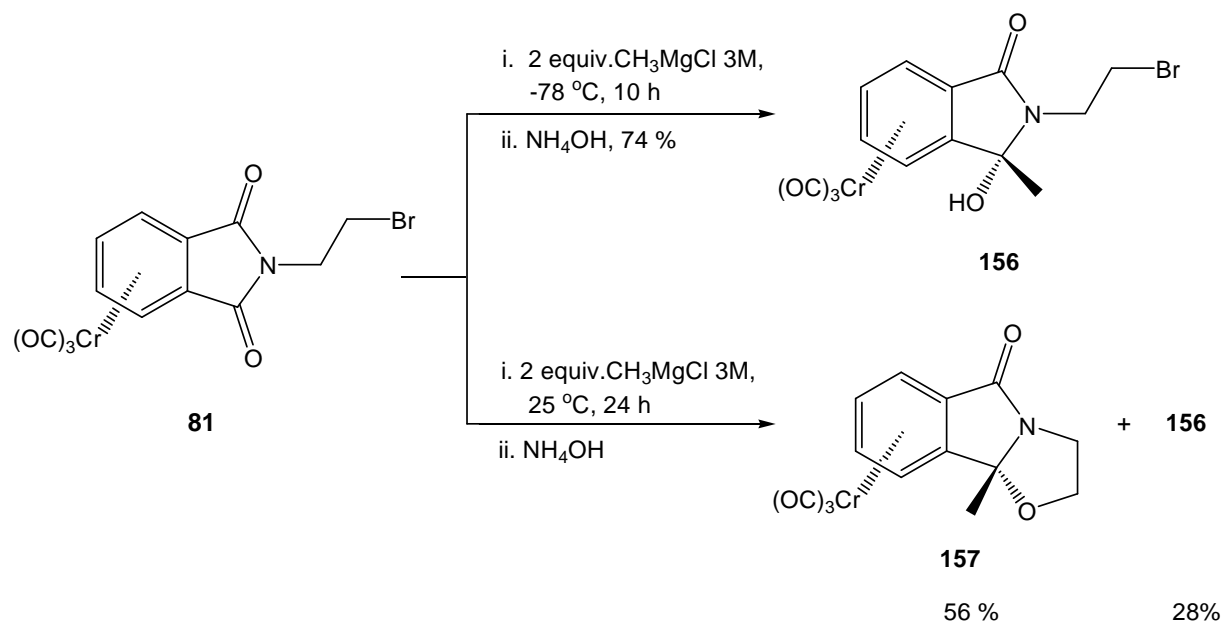

The reaction of tricarboxyl(3-hydroxy-2,3-dimethyl-2,3-dihydro-isoindol-1-one)chromium(0) (**149**) with methyl iodide in the presence of NaH gave tricarboxyl (2,3-dimethyl-3-methoxy-2,3-dihydro-isoindol-1-one) chromium(0) (**158**) as a yellow solid in 73 % yield.

Attempts to prepare the stereoisomer of complex **158** by treatment of complex **149** with either Lewis acid ($\text{BF}_3 \cdot \text{OEt}_2$) or mineral acids (HCl or H_2SO_4) as reported for similar complexes

163.^[172] Actually we got the dehydrated complex **162** as the main product in case of Lewis acid, while in case of mineral acids (HCl or H₂SO₄) we got also decomposed materials

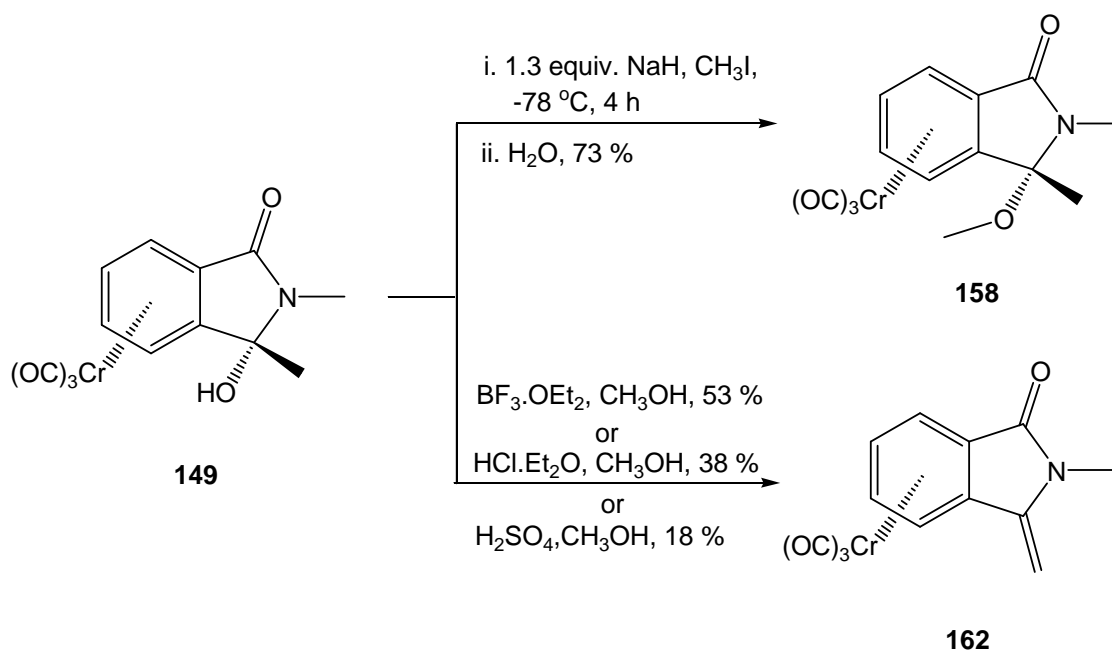

Treatment of a mixture of complex **149** and triethylsilane in THF at -78 °C with BF₃.OEt₂ gave complex **169** as a yellow solid in 61 % yield, in addition to the dehydrated product **162** as an orange solid in 11 % yield

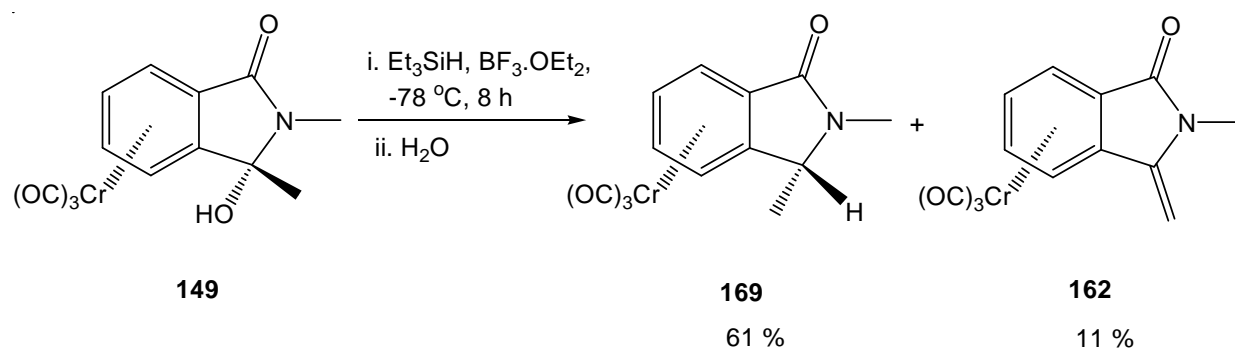

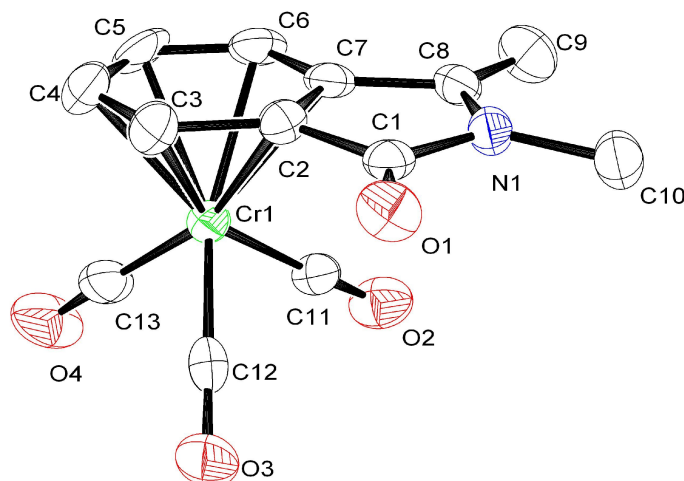

Structure of **162** in the crystal

Treatment of tricarbonyl phthalimide chromium complexes **78** and **79** with 10 mol% oxazaborolidine catalysts **180** (R = Me) and 1 equiv. of $\text{BH}_3 \cdot \text{THF}$ at 25°C for 30 min gave the optically active tricarbonyl(3-hydroxy-2-methyl-2,3-dihydro-isoindol-1-one)chromium(0) (**188**) and tricarbonyl(3-hydroxy-2-ethyl-2,3-dihydro-isoindol-1-one)chromium(0) (**189**) respectively

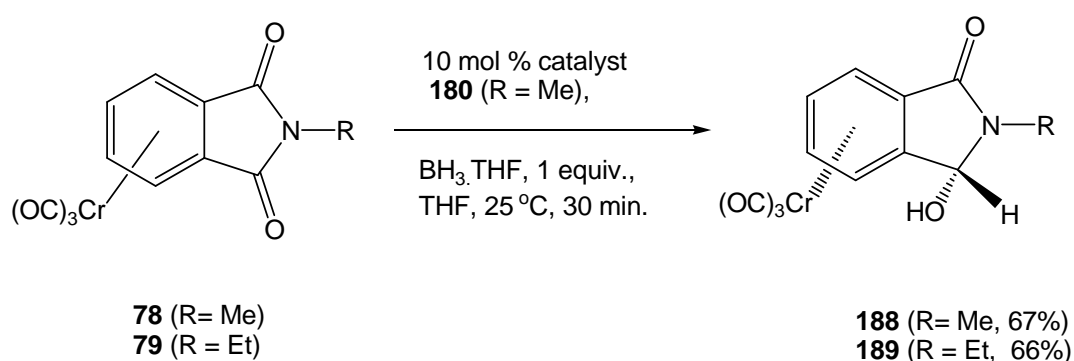

The diastereomeric ratio was deduced from the integration of peaks in ^1H NMR spectrum. The complexed aromatic ring proton peaks are almost overlapping, thus the integration of two singlets at $\delta = 3.62$ and $\delta = 3.56$ ppm for OCH_3 groups of two diastereoisomers were used for calculation of the enantiomeric excess and revealed that complex **193** was obtained in about 31 % *ee*.

Summary

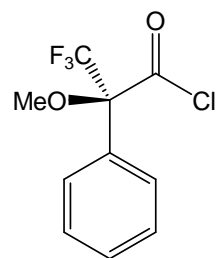

193 (*R*)-MTPA-Cl

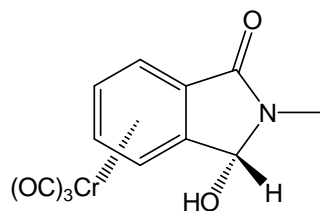

189

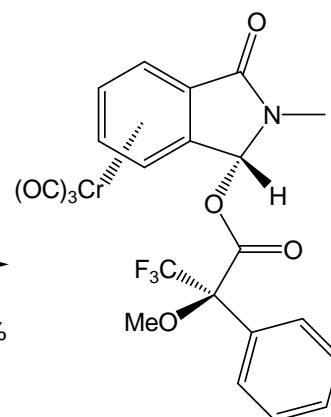
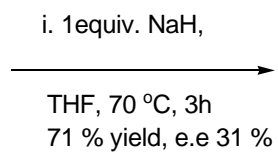

195

Experimental

1. General Remark

All operations were performed in an argon atmosphere using the Schlenk technique. Reaction vessels were heated at reduced pressure with a heat gun and flushed with argon or nitrogen. This procedure was repeated three times.

Solvents were dried and argonated before use. Diethyl ether and THF were distilled from sodium wire/benzophenone under nitrogen; petroleum ether (PE), *tert*-butylmethyl ether (TBME) and ethyl acetate were dried with calcium chloride. Hexane, dibutyl ether, methylene chloride and were dried with calcium hydride.

Preparative column chromatography was carried out using flash chromatography. Silica gel (J. T. Baker, \varnothing 40 μm) was degassed by heating it with a heat gun at reduced pressure followed by setting it under normal pressure with argon. All the solvents used for column chromatography were distilled over drying agents e.g. calcium chloride, calcium hydride, and then argonated for about 20 min by flowing with a constant argon stream.

Thin layer chromatography (TLC) was carried out using aluminum TLC plates coated with the silica gel 60F₂₅₄ from Merck (Polygram[®]). The detection of changed substances over the TLC was done with the help of a UV-lamp ($\lambda = 254 \text{ nm}$) or developed with Ce(IV) sulfate reagent.

Infrared Spectra (IR) were obtained using a spectrometer Perkin-Elmer FT 1710 with Golden Gate ATR. The following abbreviations were used to indicate the intensity of the absorption bands: s = strong, m = middle, w = weak, br = broad.

Mass spectrometry (MS) was carried out using a Finnegan AM 400 mass spectrometer (ionization potential 70 eV). FAB-MS spectra were carried out using a VG-Autospec spectrometer in a low resolution measurement with a nitrobenzyl alcohol matrix (NBA-Matrix). LC-MS (ESI) mass spectra were recorded on a Micromass LCT with Lock-Spray-unit (ESI). The injection was done in the Loop-Mode in a HPLC-Alliance 2695 column (Waters). All values are given in atomic units of mass per elemental charge (m/z). The intensity is given as a percentage of the base peak.

High resolution mass spectra (HRMS) were recorded with the peak-matching method using perfluorokerosen (PFK) as the internal standard using a VG-Autospec spectrometer (the NBA-Matrix was used) or with the Peak-Matching method in a Micromass LCT spectrometer with Lock-Spray-unit (ESI).

¹H NMR spectra were measured using instruments Bruker WP 200 (200.1 MHz) and AVS 400 (400.1 MHz) at 25 °C. In the case no tetramethylsilane (TMS, $\delta = 0.00$) was used as a reference, residual solvent signals (acetone $\delta = 2.05$ ppm, chloroform $\delta = 7.26$) as internal standards. The multiplicity of the peaks were abbreviated as s (singlet), d (doublet), t (triplet), q (quartet), m (multiplet), br (broad).

¹³C NMR spectra were measured using the instrument Bruker AVS 200 (50.3 MHz) and AVS 400 (100.6 MHz). . In the case no tetramethylsilane (TMS, $\delta = 0.00$) was used as a reference, residual solvent signals (acetone $\delta = 29.8$ ppm, chloroform $\delta = 77.0$) as internal standards. The multiplicity of the signals was determined with APT and DEPT techniques. Signals (peaks) with negative phase for CH and CH₃ were labeled with “-”, and those with positive phase for C and CH₂ were labeled with “+”. Air sensitive samples prepared under argon using the Schlenk technique. The deuterated solvents were stored under argon.

³¹P NMR spectra were measured using the instrument Bruker AVS 400 (162 MHz). A solution of H₃PO₄ 30 % in water was used as external reference.

Melting points were determined with the Electrothermal IA 9200 Series Digital Melting Point Apparatus.

Elemental analyses were carried out for CHN with element Vario EL instrument, with acetanilide as the standard. All values are given as mass percentages.

Reagents were purchased from commercial suppliers (Across, Aldrich, Fluka, Lancaster, Merck) and used without further purification.

2. Synthesis of *N*-substituted-phthalimide tricarbonylchromium(0) complexes

2.1 General procedure for the synthesis of *N*-substituted phthalimide tricarbonyl chromium(0) complexes (GP1):

The phthalimide and 1.1 equiv. of hexacarbonylchromium in dibutyl ether and THF (10:1) are heated at 118-120 °C for 17 h to 48 h. After cooling to 25 °C, the reaction mixture is carefully filtered through a P4 frit covered with a 2 cm thick layer of silica gel. The solvents are removed at reduced pressure, and the crude product is purified by flash chromatography on SiO₂, eluting with TBME / PE (1:1 to TBME). The tricarbonylchromium phthalimide complexes are obtained as red solids, which are moderate air stable.

2.1.1 Tricarbonyl(phthalimide)chromium(0)(72)^[98]

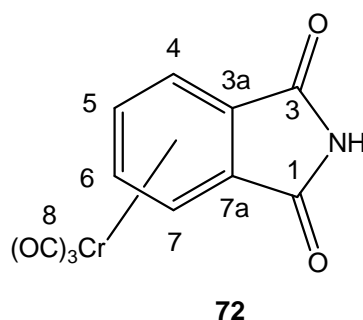

GP1. (1,00 g, 6.8 mmol) of phthalimide (**71**) and (1.65 g, 7.5 mmol) of hexacarbonylchromium in 80 mL Bu₂O and 8 mL THF were heated at reflux for 48 h. Purification by flash chromatography (200 x 20 mm, PE / TBME 1:3, then TBME) to yield product **72** (1.35 g, 4.8 mmol, 70 %) as a red solid, m.p. 205 °C (dec.).

IR (ATR): $\tilde{\nu}$ = 3199 (m, NH) cm⁻¹, 1979 (s, CO), 1928 (s, CO), 1904 (m, CO), corresponding to Cr(CO)₃ group, 1716 (m, CO) of the amide group, 1605(m), 1307 (s), 1052 (s), – ¹H NMR (400.1 MHz, [D₆] acetone): δ = 5.97 [m, 2H, 5(6)-H], 6.30 [m, 2H, 4(7)-H], 10.30 (s, 1H, N-H). – ¹³C NMR (100.6 MHz, [D₆] acetone, DEPT): δ = 90.0 [–, C-4(7)], 94.6 [+ , C-3a(7a)], 94.8 [–, C-5(6)], 168.8 [+ , C-1(3)], 231.7 (+, C-8) ppm. – MS (70 eV): m/z (%) = 283 (17) [M⁺], 227 (7) [M⁺ – 2CO], 199 (97) [M⁺ – 3CO], 147 (97) [M⁺ – Cr(CO)₃], 104 (82), 77 (12), 76 (98), 52 (100) [⁵²Cr]. – HRMS C₁₂H₇NO₅Cr: calcd. 296.9729, found. 296.9727. Elemental analyses: calcd. : C, 46.66; H, 1.78; N, 4.95, found: C, 46.91; H, 1.82; N, 4.99.

2.1.2 Tricarbonyl(*N*-methylphthalimide)chromium(0) (**78**)^[98]

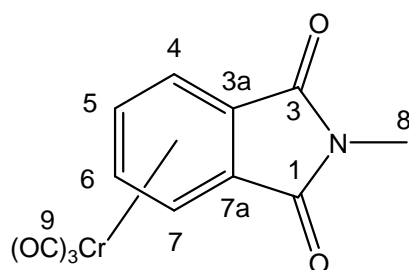

78

GP1. (1.00 g, 6.2 mmol) *N*-methylphthalimide (**74**)^[99] and (1.50 g, 6.8 mmol) hexacarbonylchromium in 70 mL of Bu₂O and 7 mL of THF were heated under Argon at reflux for 35 h. After filtration and solvent removal at reduced pressure, the reaction mixture was separated by column chromatography (200 x 20 mm, PE / TBME 1:3) to yield (1.13 g, 3.80 mmol, 61 %) of **78** as a deep red solid, m.p. 196 °C.

IR (ATR): $\tilde{\nu}$ = 3082 (w) cm⁻¹, 2961 (w), 1974 (s, CO), 1894 (s, CO), 1761 (m), 1698 (s), 1432 (m), 1371 (m), 1249 (w), 1203 (w), 1141 (w), 1080 (w), 1005 (m), 954 (w), 846 (w), 799 (w), 751 (w), 703 (w). – ¹H NMR (400.1 MHz, CDCl₃): δ = 3.13 (s, 3H, 8-H), 5.52 [s, 2H, 5(6)-H], 6.05 [s, 2H, 4(7)-H] ppm. – ¹³C NMR (100.6 MHz, CDCl₃, DEPT): δ = 24.5 (–, C-8), 87.3 [–, C-4(7)], 90.6 [–, C-5(6)], 90.8 [+ , C-3a(7a)], 167.2 [+ , C-1(3)], 228.9 (+, C-9) ppm. – MS (70 eV): m/z (%) = 297 (53) [M⁺], 241 (20) [M⁺ – 2CO], 213 (97) [M⁺ – 3CO], 161 (25) [M⁺ – Cr(CO)₃], 117 (10), 104 (12), 76 (19), 52 (100) [⁵²Cr]. – HRMS C₁₂H₇NO₅Cr: calcd. 296.9729, found. 296.9727. Elemental analyses: calcd. : C, 48.50; H, 2.37; N, 4.71, found: C, 48.94; H, 2.50; N, 4.78.

2.1.3 Tricarbonyl(*N*-ethylphthalimide)chromium(0) (**79**)

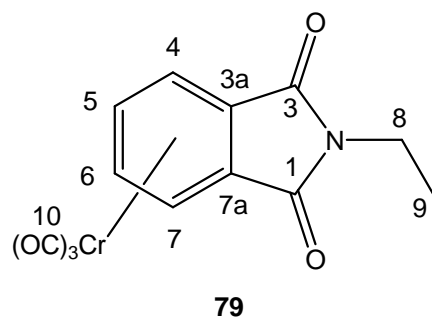

GP1. (1.1 g, 6.2 mmol) *N*-ethylphthalimide (**75**)^[100] and (1.50 g, 6.8 mmol) hexacarbonyl chromium in 70 mL of Bu₂O and 7 mL of THF were heated under Argon at reflux for 30 h. After filtration and solvent removal at reduced pressure, the reaction mixture was separated by column chromatography (200 x 20 mm, PE / TBME 1:3) to yield (1.13 g, 3.80 mmol, 57 %) of **79** as a deep red solid. m.p. 111 °C.

IR (ATR): $\tilde{\nu}$ = 3080 (w) cm⁻¹, 2960 (w), 1971 (s, CO), 1893 (s, CO), 1765 (m, CO), 1704 (s, CO), 1439 (m), 1374 (m), 1265 (w), 1189 (w), 1155 (w), 1033 (w), 893 (w), 872 (w), 842 (w), 755 (w), 703 (w). – ¹H NMR (400.1 MHz, CDCl₃): δ = 1.26 (t, *J* = 6.3 Hz, 3H, CH₃), 3.70 (q, *J* = 6.5 Hz, 2H, CH₂), 5.52 [s, 2H, 5(6)-H], 6.06 [s, 2H, 4(7)-H] ppm. – ¹³C NMR (100.6 MHz, CDCl₃, DEPT): δ = 13.6 (–, C-9), 33.8 (+, C-8), 87.5 [–, C-4(7)], 90.7 [–, C-5(6)], 91.0 [+ , C-3a(7a)], 167.2 [+ , C-1(3)], 229.0 (+, C-10) ppm. – MS (70 eV): *m/z* (%) = 311 (25) [M⁺], 255 (9) [M⁺ – 2CO], 227 (99) [M⁺ – 3CO], 175 (15) [M⁺ – Cr(CO)₃], 133 (11), 77 (11), 52 (100) [⁵²Cr]. – HRMS C₁₃H₉NO₅Cr: calcd. 310.9886, found. 310.9888. Elemental analyses: calcd. C, 50.17; H, 2.91; N, 4.50, found: C, 50.18; H, 2.75; N, 4.58.

2.1.4 Tricarbonyl(*N*-vinylphthalimide)chromium(0) (**80**)^[98]

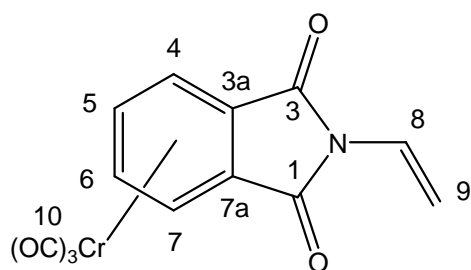

80

Method A

GP1. (0.50 g, 2.8 mmol) vinylphthalimide (**76**)^[101,102] and (0.70 g, 3.2 mmol) hexacarbonylchromium in 50 mL of Bu₂O and 5 mL of THF were heated under argon at reflux for 30 h. After filtration and solvent removal at reduced pressure, the reaction mixture was purified by column chromatography (200 x 20 mm, PE / TBME 1:2) to yield product **80** (0.38 g, 1.2 mmol, 38%) as a deep red solid. m.p. 201 °C.

¹H NMR (400.1 MHz, CDCl₃): δ = 5.07 (d, ²J_{cis} = 9.8 Hz, 1H, 9-H), 5.46 [dd, J = 2.5 Hz, 2H, 5(6)-H], 6.03 [m, 3H, 4(7)-H, 9-H], 6.75 (m, 1H, 8-H) ppm. – ¹³C NMR (100.6 MHz, CDCl₃, DEPT): δ = 87.2 [–, C-4(7)], 89.6 [+ , C-3a(7a)], 90.8 [–, C-5(6)], 105.9 (+, C-9), 123.3 (–, C-8), 165.6 [+ , C-1(3)], 228.5 (+, C-10) ppm. – MS (70 eV): m/z (%) = 309 (45) [M⁺], 253 (32) [M⁺ – 2CO], 225 (83) [M⁺ – 3CO], 209 (46), 173 (33) [M⁺ – Cr(CO)₃], 154 (13), 129 (8), 108 (10), 97 (35), 80 (28), 69 (63), 52 (100) [⁵²Cr]. – HRMS C₁₃H₇NO₅Cr: calcd. 308.9729, found. 308.9729. Elemental analyses: calcd. C, 50.50; H, 2.28; N, 4.53, found: C, 50.23; H, 2.74; N, 4.61.

Method B

(0.5 g, 2.8 mmol) vinylphthalimide (**76**) and (0.8 g, 3.1 mmol) of tricarbonyl(naphthalene) chromium(0) in 50 mL THF was heated at reflux for 15 h., the solvent removed under reduced pressure. Then the crude product was purified by column chromatography (200 x 20 mm, PE/TBME 1:1, then 1:2). 0.35 g (1.1 mmol, 40 %) of **80**.

2.1.5 Tricarbonyl(*N*-2-bromoethylphthalimide)chromium(0) (**81**)

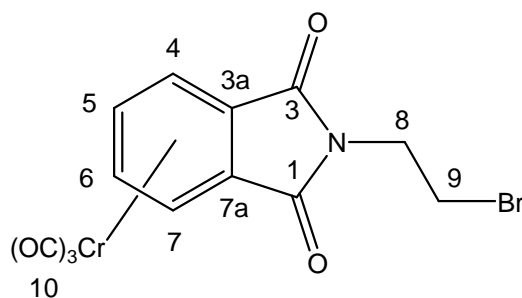

81

GP1. (1.00 g, 3.93 mmol) of *N*-2-bromoethylphthalimide (**77**) and (0.95 g, 4.33 mmol) of hexacarbonylchromium in 60 mL of Bu₂O and 6 mL of THF were heated at reflux for 17 h. Purification by flash chromatography (200 x 20 mm, PE / TBME 1:3) to yield 0.64 g of product **81** (1.6 mmol, 42 %) as a red solid. m.p.127 °C.

IR (ATR): $\tilde{\nu}$ = 3032 (w) (CH), 2961 (w), 1974 (s, CO), 1894 (s, CO), 1761 (m, CO), 1698 (s, CO), 1432 (m), 1371 (m), 1249 (w), 1203 (w), 1141 (w), 1080 (w), 1005 (m), 954 (w), 846 (w), 799 (w), 751 (w), 703 (w) cm⁻¹. – ¹H NMR (400.1 MHz, CDCl₃): δ = 3.5 (t, *J* = 6.8 Hz, 2H, 9-H), 4.0 (t, *J* = 6.9 Hz, 2H, 8-H), 5.53 [m, 2H, 5(6)-H], 6.05 [m, 2H, 4(7)-H] ppm. – ¹³C NMR (100.6 MHz, CDCl₃, DEPT, HMQC): δ = 28.7 (+, C-9), 42.3 (+, C-8), 86.2 [–, C-4(7)], 91.1 [–, C-5(6)], 92.5[+, C-3a(7a)], 166.3 [+, C-1(3)], 232.9 (+, C-10) ppm. – MS (70 eV): *m/z* (%) = 389, 391 (11), (11) [M⁺], 333, 335 (4), (4) [M⁺ – 2CO], 311 [M⁺ – Br], 305 (11), 307 (10) [M⁺ – 3CO], 277 (70). 279 (67) [M⁺ – (CO)₄], 253 (3), 255 (4) [M⁺ – Cr(CO)₃], 227 [M⁺ – Br – 3(CO)], 174 [M⁺ – Br – Cr(CO)₃], 160 (39), 130 (67), 102 (13), 52 (100) [Cr]. – HRMS C₁₃H₈BrCrNO₅: calcd. 388.8991, found 388.8991. Elemental analyses: calcd. C, 40.02; H, 2.07; N, 3.59, found: C, 40.43; H, 2.14; N, 3.61.

2.1.6 Tricarbonyl (potassiumphthalimide)chromium(0) (**82**)^[98]

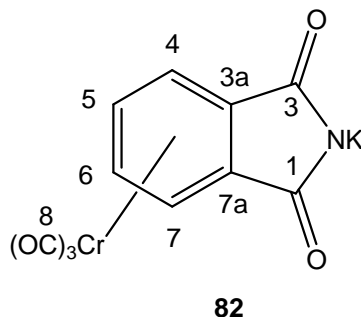

(0.50 g 1.8 mmol) of tricarbonyl(phthalimide)chromium (**72**) was dissolved in 5.2 mL ethanol at 50 °C. The solution of 0.10 g (1.8 mmol) of potassiumhydroxid in 5.6 mL of ethanol was added dropwise and stirred for 2 h at 50 °C, the colour of the solution changing from red to orange. The mixture was cooled to 25 °C and the orange solid precipitated in the solution. After filtration, 0.54 g (1.7 mmol, 93 %) of **82** was obtained as orange air stable solids. m.p > 300 °C.

IR (ATR): $\tilde{\nu}$ = 3080 (w), 1963 (s, CO), 1894 (s, CO), 1768 (m, CO), 1693 (s, CO), 1580 (s), 1379 (m), 1298 (w), 1125 (w), 1088 (w), 1051 (w), 793 (w), 711 (w) cm^{-1} . – ^1H NMR (400.1 MHz, $[\text{D}_6]$ acetone): δ = 5.69 [m, 2H, 5(6)-H], 6.00 [m, 2H, 4(7)-H]. – ^{13}C NMR (100.6 MHz, $[\text{D}_6]$ acetone, DEPT): δ = 87.9 [–, C-4(7)], 92.9 [–, C-5(6)], 94.0 [+ , C-3a(7a)], 168.9 [+ , C-1(3)], 232.6 (+ , C-8) ppm. LC-MS (ESI): $(\text{C}_{11}\text{H}_4\text{NO}_5\text{CrK})$ [+H]: calcd.321.9130, found. 321.9133

2.1.7 Tricarbonyl(*N*-phenylphthalimide)chromium(0) (**101** and **102**)

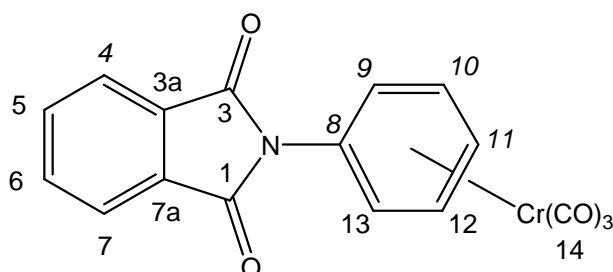

101

GP1. (1.5 g, 6.7 mmol) of *N*-phenyl phthalimide (**100**) and (1.63 g, 7.4 mmol) of hexacarbonylchromium in 100 mL of Bu₂O and 10 mL of THF were heated at reflux for 48 h. Purification by flash chromatography (200 x 20 mm, PE / TBME 1:3) gave 0.75 g (2.0 mmol, 31 %) of **101** as a yellow solid. m.p. 162 °C, then (TBME)) to give 0.26 g (0.7 mmol, 11 %) of **102** as a red solid. m.p. 157 °C.

Tricarbonyl (*N*- η^6 phenyl phthalimide) chromium (0) (**101**)

IR (ATR): $\tilde{\nu}$ = 3103 (w), 1958 (s, CO), 1863 (s, CO), 1778 (m, CO), 1711 (s, CO), 1526 (m), 1460 (m), 1355 (m), 1223 (w), 1078 (w), 1046 (w), 878 (w), 812 (w), 794 (w), 713 (w), 670 (w) cm⁻¹. – ¹H NMR (400.1 MHz, CDCl₃): δ = 5.3 (t, *J* = 5.6 Hz, 1H, 11-H), 5.4 [t, *J* = 5.9 Hz, 2H, 10(12)-H], 5.9 [d, *J* = 6.3 Hz, 2H, 9(13)-H], 7.8 [s, 2H, 5(6)-H], 7.9 [s, 2H, 4(7)-H] ppm. – ¹³C NMR (100.6 MHz, CDCl₃, DEPT, HMQC): δ = 89.4 [–, C-9(13)], 90.7 [–, C-10(12)], 90.8 [–, C-11], 106.3 [+ , C-8], 124.0 [–, C-4(7)], 130.9 [+ , C-3a(7a)], 135.0 [–, C-5(6)], 166.1 [+ , C-1(3)], 231.9 (+, C-14) ppm. – MS (70 eV): *m/z* (%) = 359 (5) [M⁺], 303 (9) [M⁺ – 2CO], 275 (100) [M⁺ – 3CO], 223 (10) [M⁺ – Cr(CO)₃], 153 (11), 77 (16), 52 (79) [⁵²Cr]. – HRMS C₁₇H₉NO₅Cr: calcd. 358.9886, found. 358.9888. Elemental analysis: calcd. C, 56.84; H, 2.53; N, 3.90, found: C, 57.13; H, 2.27; N, 4.11.

Tricarbonyl (*N*-phenyl η^6 phthalimide) chromium (0) (**102**)

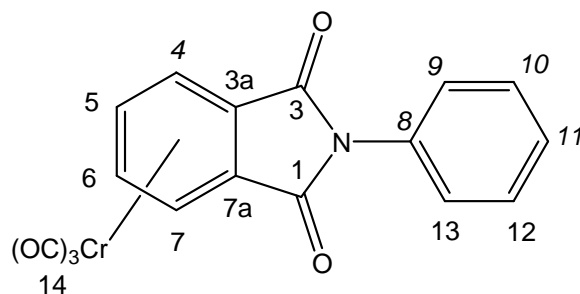

102

IR (ATR): $\tilde{\nu}$ = 3088 (w), 1980 (s, CO), 1934 (s, CO), 1895 (s, CO), 1711 (s, CO), 1499 (m), 1406 (w), 1373 (s), 1224 (w), 1116 (w), 1063 (w), 879 (w), 848 (w), 760 (w), 705 (w), 689 (w) cm^{-1} . – ^1H NMR (400.1 MHz, CDCl_3): δ = 5.5 [s, 2H, 5(6)-H], 6.1 [s, 2H, 4(7)-H], 7.28 [m, 2H, 10(12)-H], 7.39 (m, 1H, 11-H), 7.51 [m, 2H, 9(13)-H] ppm. – ^{13}C NMR (100.6 MHz, CDCl_3 , DEPT, HMQC): δ = 87.5 [–, C-4(7)], 90.1 [+ , C-3a(7a)], 90.8 [–, C-5(6)], 126.7 [–, C-10(12)], 128.7 [–, C-11], 129.2 [–, C-9(13)], 130.9 [+ , C-8], 166.3 [+ , C-1(3)], 228.7 (+, C-14) ppm. – MS (70 eV): m/z (%) = 359 (12) [M^+], 303 (6) [$\text{M}^+ - 2\text{CO}$], 275 (100) [$\text{M}^+ - 3\text{CO}$], 223 (64) [$\text{M}^+ - \text{Cr}(\text{CO})_3$], 179 (46), 105 (12), 77 (18), 52 (67) [^{52}Cr]. – HRMS $\text{C}_{17}\text{H}_9\text{NO}_5\text{Cr}$: calcd. 358.9886, found. 358.9888. Elemental analyses: calcd. C, 56.84; H, 2.53; N, 3.90, found : C, 57.09; H, 2.69; N, 4.09.

3 General procedure for the photolysis of *N*-substituted phthalimide tricarbonyl chromium complexes **115-120** (GP2):

Phosphine or phosphite (2 equiv.) was added to a solution of the tricarbonyl phthalimide chromium complexes **72**, **78**, **79** (1 equiv.) in toluene (40 mL). Then the reaction mixture was irradiated for 30 min to 3 h with a 125 W mercury lamp in quartz cell with continuous argon bubbling through the reaction mixture and continuous cooling using a water condenser, the reaction progress being monitored by TLC. When the TLC indicated no more starting material, the solvent was removed at reduced pressure and the crude product was purified by short-degassed column chromatography (SiO₂, PE / TBME)

3.1 [Dicarbonyl(phthalimide)triphenylphosphine]chromium(0) (**115**)

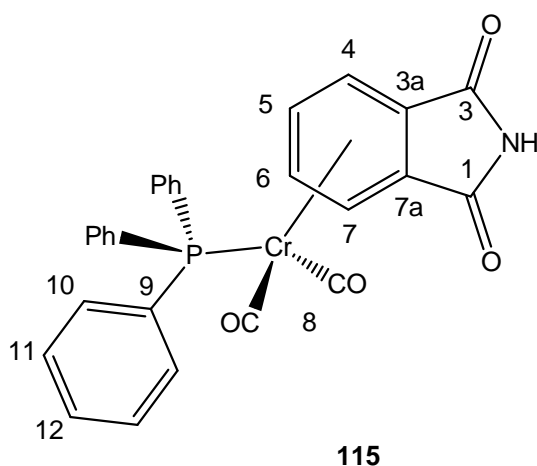

GP2. (0.25 g, 0.9 mmol) of **72** in toluene (40 mL), triphenylphosphine (0.46 g, 1.8 mmol), irradiation for 1.5 h, column chromatography (100 x 20 mm, PE then TBME/PE, 1:2) afforded (0.18 g, 0.4 mmol, 40%) of **115** as a deep brown solid. m. p. 172 °C.

IR (ATR): $\tilde{\nu}$ = 3196 (br, NH), 3030 (w, arom. H), 1931 (s, CrCO), 1879 (s, CrCO), 1730 (s, CO, CrCO), 1707 (m, NCO), 1605 (m), 1308 (m), 1053 (s), 719 (s), 694 (s) cm⁻¹. – ¹H NMR (400.1 MHz, [D₆] acetone): δ = 4.84 [m, 2H, 5(6)-H], 5.70 [m, 2H, 4(7)-H], 7.45 (m, 15H, 10-, 11-, 12- H), 9.87 (s, 1H, NH) ppm. – ¹³C NMR (100.6 MHz, [D₆] acetone, APT): δ = 86.3 [–, C-4(7)], 86.5 [+ , C-3a(7a)], 93.0 [–, C-5(6)], 129.2 (–, ³J_{P-C} = 10 Hz, C-11), 130.7 (–, C-12), 133.8 (–, ²J_{P-C} = 11 Hz, C-10), 138.5 (+, J_{P-C} = 37 Hz, C-9), 169.6 [+ , CO, C-1(3)], 238.6, (+, ²J_(P-CO) = 21 Hz, C-8). – ³¹P NMR (162 MHz, [D₆] acetone): δ = 82.43 ppm. – MS (70 eV): *m/z* (%) = 517 (1) [M⁺], 461 (4) [M⁺ – 2 CO], 314 (15) [CrPPh₃], 262 (100) [PPh₃],

183 (74), 147 (15) [$M^+ - Cr(CO)_2PPh_3$], 108 (41), 77 (8), 52 (9) [Cr]. – HRMS $C_{28}H_{20}CrNO_4P$: calcd. 517.0535, found 517.0533.

Elemental analyses: calcd. C, 64.99; H, 3.90; N, 2.71, found: C, 65.29; H, 4.01; N, 2.63.

3.2 [Dicarbonyl(η^6 -*N*-methylphthalimide)triphenylphosphine]chromium(0) (**116**)

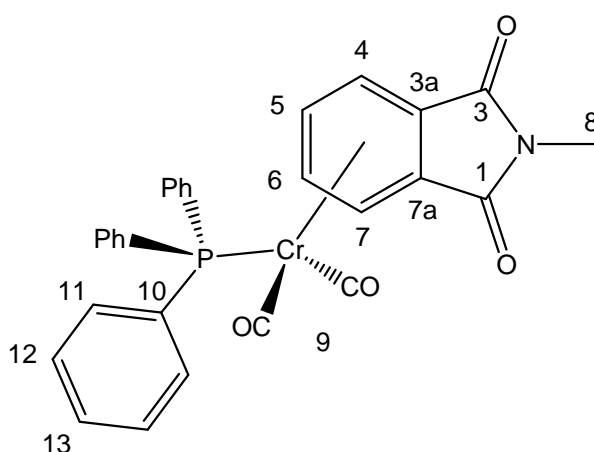

116

GP2. (0.50 g, 1.7 mmol) of **78** in toluene (40 mL), triphenylphosphine (0.88 g, 3.4 mmol), irradiation for 3 h, column chromatography (100 x 20 mm; PE then TBME/PE 1:2) afforded (0.55 g, 1.0 mmol, 61%) of **116** as a deep brown solid. m. p. 122 °C.

IR (ATR): $\tilde{\nu} = 3030$ (w, arom. CH), 2995 (w, aliph. CH) 1920 (s, CrCO), 1882 (s, CrCO), 1743 (m, CrCO), 1693 (s, NCO), 1452 (m) 998 (m), 747 (m), 693 (s) cm^{-1} . – 1H NMR (400.1 MHz, $[D_6]$ acetone): $\delta = 3.0$ (s, 3H, 8-H), 4.9 [m, 2H, 5(6)-H], 5.6 [m, 2H, 4(7)-H], 7.38 (m, 15H, 11-, 12-, 13- H) ppm. – ^{13}C NMR (100.6 MHz, $[D_6]$ acetone, APT): $\delta = 24.1$ (–, C-8), 86.0 [+ , C-3a(7a)], 86.3 [– C-4(7),], 92.6 [–, C-5(6)], 129.3 (–, $^3J_{P-C} = 9$ Hz, C-12), 130.7 [–, C-13], 133.9 [–, $^2J_{P-C} = 11$ Hz, C-11], 138.5 (+, $J_{P-C} = 36$ Hz, C-10), 169.6 [+ , C-1(3)], 238.9 (+, $^2J_{(P-CO)} = 30$ Hz, C-9) ppm. – ^{31}P NMR (162 MHz, $[D_6]$ acetone): $\delta = 82.2$ ppm. – MS (70 eV): m/z (%) = 531 (3) [M^+], 475 (24) [$M^+ - 2 CO$], 314 (67) [$CrPPh_3$], 262 (100) [PPh_3], 183 (87), 161 (30) [$M^+ - Cr(CO)_2PPh_3$], 108 (39), 77 (19), 52 (16) [Cr]. – HRMS $C_{29}H_{22}CrNO_4P$: calcd. 531.0692, found 531.0692.

Elemental analyses: calcd. C, 65.54; H, 4.17; N, 2.64, found: C, 65.89; H, 4.31; N, 2.23.

3.3 [Dicarbonyl[(η^6 -*N*-vinylphthalimide)triphenylphosphine]chromium(0) (**117**)

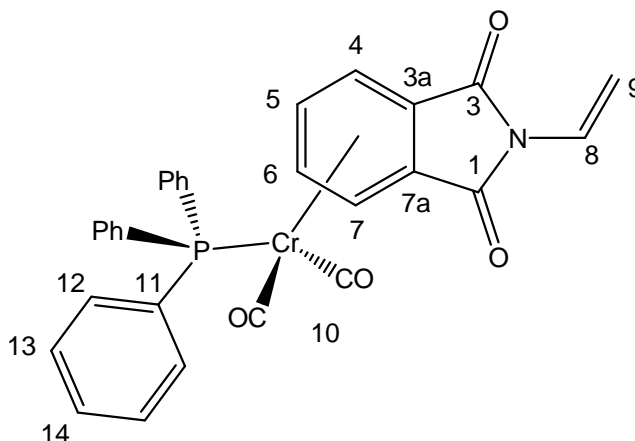

117

GP2. (0.58 g, 1.9 mmol) of **79** in toluene (40 mL), triphenylphosphine (0.98 g, 3.8 mmol), irradiation for 1.5 h, column chromatography (100 x 20 mm; PE then TBME/PE, 1:2) afforded (0.23 g, 0.4 mmol, 23%) of **117** as a deep brown solid. m. p. 64 °C.

IR (ATR): $\tilde{\nu}$ = 3090 (w, vinyl CH), 3053 (w, arom. CH) 1935 (s, CrCO), 1872 (s, CrCO), 1741 (m, NCO), 1635 (m), 1434 (m), 1366 (s), 979 (m), 743(m), 691 (s) cm^{-1} .MR (400.1 MHz, $[\text{D}_6]$ acetone): δ = 4.94 [m, 2H, 5(6)-H], 4.97 (d, $^3J_{\text{cis}} = 10$ Hz, 1H, cis-9-H), 5.80 [m, 2H,4(7)-H], 5.97 (d, $^3J_{\text{trans}} = 16$ Hz, 1H, trans-9-H), 6.80 (dd, $^3J = 19.8, 19.6$ Hz, 1H, 8-H), 7.4 (m, 15H, arom. H) ppm. – ^{13}C NMR (100.6 MHz, $[\text{D}_6]$ acetone, APT): δ = 84.2 [+ , C-3a(7a)], 86.8 [- , C- 4(7)], 92.2 [- , C- 5(6)], 103.7 (+ , C-9), 125.0 (- , C-8), 129.3 (- , $^3J_{\text{P-C}} = 9$ Hz C-13), 130.8 (- , C-14), 133.9 (- , $^2J_{\text{P-C}} = 10$ Hz, C-12), 138.2 (+ , $J_{\text{P-C}} = 37$ Hz, C-11), 168.1 [+ , C-1(3)], 238.4 (+ , $^2J_{\text{(P-CO)}} = 21$ Hz, C-10). – ^{31}P NMR (162 MHz, $[\text{D}_6]$ acetone) δ = 80.93 ppm. – MS (70 eV): m/z (%) = 543 (2) [M^+], 487 (15) [$\text{M}^+ - 2\text{CO}$], 314 (56) [CrPPh_3], 262 (100) [PPh_3], 183 (48), 173 (25) [$\text{M}^+ - \text{Cr}(\text{CO})_2\text{PPh}_3$], 108 (37), 76 (14), 52 (45) [Cr]. – HRMS $\text{C}_{30}\text{H}_{22}\text{CrNO}_4\text{P}$: calcd. 543.0692, found 543.0696.

Elemental analyses: calcd. C, 66.30; H, 4.08; N, 2.58, found: C, 66.59; H, 4.35; N, 2.43.

3.4 [Dicarbonyl(η^6 -*N*-methylphthalimide)trimethylphosphine]chromium(0) (**118**)

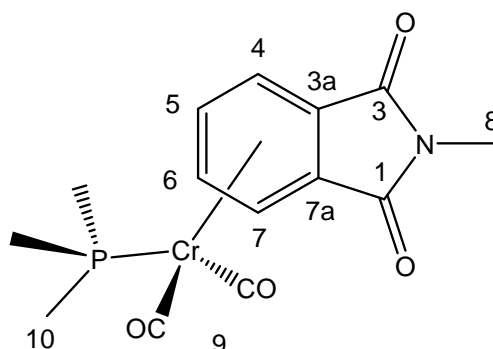

118

GP2. (0.25 g, 0.8 mmol) of **78** in toluene (40 mL), trimethylphosphine (0.13 g, 1.7 mmol), irradiation for 3 h, column chromatography (100 x 20 mm; PE then TBME / PE 1:1) afforded (0.16 mg 0.5 mmol, 62%) of **118** as a deep brown solid. m. p. 109 °C.

IR (ATR): $\tilde{\nu}$ = 2929 (w, aliph. CH) 1917 (s, CrCO), 1867 (s, CrCO), 1723 (m, CrCO), 1696 (s, NCO), 1428 (m), 1375 (M) 948 (m), 717 (s) cm^{-1} , – ^1H NMR (400.1 MHz, $[\text{D}_6]$ acetone): δ = 1.41 [s, 9H, $\text{P}(\text{CH}_3)_3$], 3.03 (s, 3H, 8-H), 5.38 [m, 2H, 5(6)-H], 5.80 [m, 2H, 4(7)-H] ppm. – ^{13}C NMR (100.6 MHz, $[\text{D}_6]$ acetone, APT): δ = 20.4 (–, $J_{\text{P-C}} = 26$ Hz, C-10), 23.9 (–, C-8), 85.5 [+ , C-3a(7a)], 85.7 [–, C-5(6)], 88.9 [–, C-4(7)], 169.9 [+ , C-1(3)], 238.2 (+, $^2J_{\text{P-CO}} = 22$ Hz, C-10); ^{31}P NMR (162 MHz, $[\text{D}_6]$ acetone) δ = 35.32 ppm. – MS (70 eV): m/z (%) = 345 (26) [M^+], 289 (46) [$\text{M}^+ - 2\text{CO}$], 213 (32) [$\text{M}^+ - \text{P}(\text{CH}_3)_3 - 2\text{CO}$], 161 (98) [$\text{M}^+ - \text{CrCO}_2\text{P}(\text{CH}_3)_3$], 128 (77) [$\text{CrP}(\text{CH}_3)_3$], 117 (76), 104 (80), 76 (100) [$\text{P}(\text{CH}_3)_3, \text{C}_6\text{H}_4$], 52 (71) [Cr]. – HRMS $\text{C}_{14}\text{H}_{16}\text{CrNO}_4\text{P}$: calcd. 345.0222, found 345.0219.

Elemental analyses: calcd. C, 48.70; H, 4.67; N, 4.06, found: C, 48.92; H, 4.75; N, 4.11.

3.5 [Dicarbonyl(η^6 -*N*-methylphthalimide)triethylphosphite]chromium(0) (**119**)

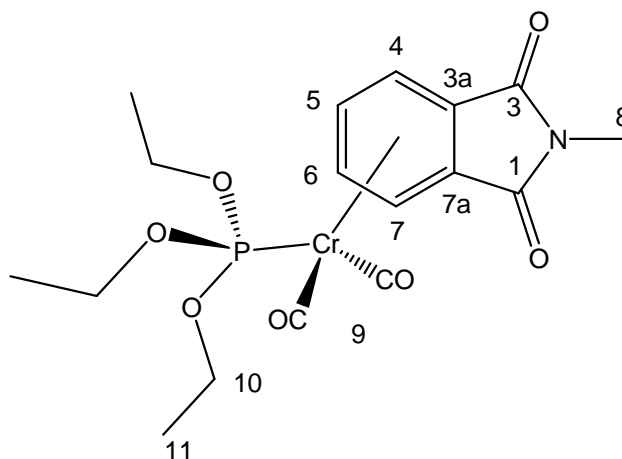

119

GP2. (0.25 g, 0.8 mmol) of **78** in toluene (40 mL), triethylphosphite (0.14 g, 0.85 mmol), irradiation for 3 h, column chromatography (100 x 20 mm; PE then TBME / PE 1:1) afforded (0.17 g, 0.4 mmol, 45%) of **119** as a deep brown solid. m. p. 124 °C.

IR (ATR): $\tilde{\nu}$ = 2977 (w, aliph. CH) 1931 (m, CrCO), 1844 (s, CrCO), 1740 (m, CrCO), 1695 (s, NCO), 1430 (m), 1023 (s) 924 (m), 717 (m), 693 (s) cm^{-1} . – ^1H NMR (400.1 MHz, $[\text{D}_6]$ acetone): δ = 1.23 (t, 9H, J = 7 Hz, 3CH₃, 11-H), 3.07 (s, 3H, 8-H), 3.82 (q, 6H, J = 8 Hz, 3OCH₂), 4.88 [m, 2H, 5(6)-H], 5.37 [m, 2H, 4(7)-H], ppm. ^{13}C NMR (100.6 MHz, $[\text{D}_6]$ acetone, APT): δ = 16.1 (–, C-11), 23.9 (–, C-8), 60.6 (+, C-10), 80.9 [–, C-5(6)], 82.6 [+ , C-3a(7a)], 86.9 [–, C-4(7)], 171.1 [+ , C-1(3)], 236.3 (+, $^2J_{\text{P-CO}}$ = 32 Hz, C-9). ^{31}P NMR (162 MHz, $[\text{D}_6]$ acetone) δ = 8.2 ppm. – MS (70 eV): m/z (%) = 435 (5) $[\text{M}^+]$, 379 (44) $[\text{M}^+ - 2\text{CO}]$, 213 (17) $[\text{M}^+ - \text{P}(\text{OC}_2\text{H}_5)_3 - 2\text{CO}]$, 161 (66) $[\text{M}^+ - \text{CrCO}_2\text{P}(\text{OC}_2\text{H}_5)_3]$, 218 (98) $[\text{CrP}(\text{OC}_2\text{H}_5)_3]$, 166 (24) $[\text{P}(\text{OC}_2\text{H}_5)_3]$, 52 (31) $[\text{Cr}]$. – HRMS C₁₇H₂₂CrNO₇P: calcd.435.0539, found 435.0536.

Elemental analyses: calcd. C, 46.90; H, 5.09; N, 3.22, found: C, 47.08; H, 5.11; N, 3.24.

4 General procedure for the nucleophilic addition to *N*-substituted phthalimide tricarbonylchromium (GP3)

A solution of the nucleophile in THF or Et₂O was added dropwise at –78 °C to a cooled the solution (–78 °C) of the complex in THF or Et₂O. After stirring for 2 to 16 h at –78 °C till TLC indicated no starting material, the reaction was hydrolyzed by addition of either saturated aqueous NH₄Cl or 1 M HCl at –78 °C. The color of the reaction mixture changed from red to yellow or orange. The reaction was allowed to warm up to 20 °C, and extracted with portions of ethyl acetate (15 mL) till the aqueous layer remained colorless. The collected organic layers were washed with water and dried over MgSO₄, filtered through P4-frit cover with 2 cm thick layer of silica gel. After solvent removal of at reduced pressure the crude product was purified by flash chromatography (200 x 20 mm, TBME / PE or ethyl acetate).

4.1 Tricarbonyl(3-hydroxy-1-methyl-2,3-dihydro-isoindol-1-one)chromium(0) (**147**)

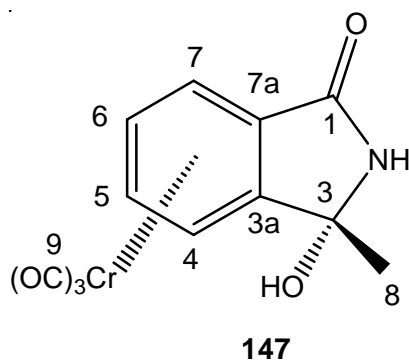

GP1, To the cooled solution of (0.30 g 1.0 mmol) of **72** in THF (30 mL) was added 2.2 mL (3.1 mmol) of methylolithium (1.0 M in THF) at –78 °C, stirring for 3 h, extracted three times with ethyl acetate, purified by column chromatography (200 x 20 mm, TBME). (0.27 g, 0.9 mmol, 84 %) of **147** as yellow solid, m. p. 178 °C (dec.).

Experimental

IR (ATR): $\tilde{\nu}$ = 3390, 3308 cm^{-1} (w, OH, NH), 2982(w), 1976 (s, CO), 1885 (s, CO), 1719 (m), 1681(m), 1431 (w), 1400 (m), 1156 (m), 1090 (m), 1074 (w), 1057 (w), 1027 (m), 949

(m), 877 (w), 840 (w). – ^1H NMR (400.1 MHz, CDCl_3): δ = 1.86 (s, 3H, 8-H), 5.54 (s, 1H, OH), 5.63 (m, 1H, 4-H), 5.86 (m, 2H, 5(6)-H), 6.27 (d, J = 6.4 Hz, 1H, 7-H), 8.17 (s, 1H, NH) ppm. – ^{13}C NMR (100.6 MHz, CDCl_3 , DEPT): δ = 27.3 (–, C-8), 86.0 (–, C-3), 87.1 (–, C-7), 91.5 (–, C-4), 93.0 (–, C-5), 96.1 (–, C-6), 99.0 (+, C-7a), 119.9 (+, C-3a), 167.5 (+, C-1), 233.6 (+, C-9) ppm. – MS (70 eV): m/z (%) = 299 (3) [M^+], 282 (5) [$\text{M}^+ - \text{OH}$], 281 (24) [$\text{M}^+ - \text{H}_2\text{O}$], 243 (2) [$\text{M}^+ - 2\text{CO}$], 225 (12) [$\text{M}^+ - \text{H}_2\text{O} - 2\text{CO}$], 215 (5) [$\text{M}^+ - 3\text{CO}$], 198 (23) [$\text{M}^+ - \text{OH} - 3\text{CO}$], 197 (94) [$\text{M}^+ - \text{H}_2\text{O} - 3\text{CO}$], 163 (1) [$\text{M}^+ - \text{CrCO}_3$], 145 (36) [$\text{M}^+ - \text{H}_2\text{O} - \text{CrCO}_3$], 132 (7), 117 (6), 103 (10), 90 (11), 76 (12), 52 (100) [^{52}Cr]. – HRMS $\text{C}_{12}\text{H}_9\text{CrNO}_5$: calcd. 298.9886, found. 298.9886.

Elemental analyses: calcd. C, 48.17; H, 3.03; N, 4.68, found: C, 48.51; H, 3.19; N, 4.88.

4.2 Tricarbonyl(3-hydroxy-2,3-dimethyl-2,3-dihydro-isoindol-1-one)chromium(0) (**149**)

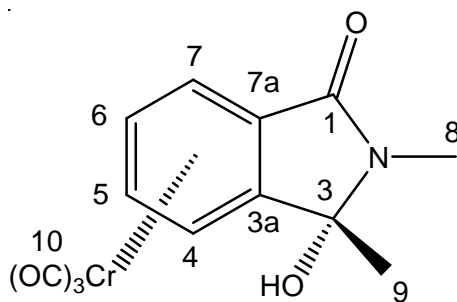

149

GP3, **1** (0.50 g, 1.7 mmol) of **78** in THF (30 mL), methyl magnesium chloride (3M in THF) (1.4 mL, 4.2 mmol), was stirred for 2 h, extracted with ethyl acetate (3 x 20 mL), purified by column chromatography (200 x 20 mm, ethyl acetate), to give **149** (0.49 g, 1.6 mmol, 93 %) as a yellow solid. m.p 158 °C, (81 %).^[98]

4.3 Tricarbonyl (3-hydroxy-2-methyl-2,3-dihydroisoindol-1-one)chromium(0) (**154**)

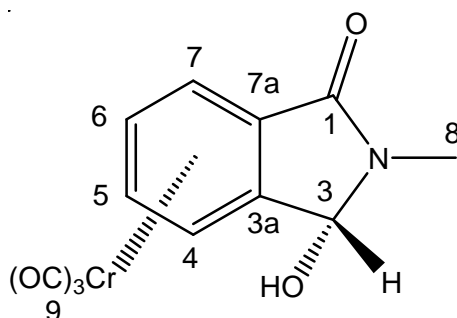

154

GP3, **1** (0.20 g, 0.67 mmol) of **78** in THF-H₂O (1:1 30 mL), NaBH₄ (3 M in THF) (0.04 g, 1.0 mmol) was mixed at -78 °C. The temperature was raised to 0 °C, stirring for 30 min, acidified with HCl (5 mL, 1 M), extracted with ethyl acetate (3 x 15 mL), purified by column chromatography (200 x 20 mm, ethyl acetate), yield to give **154** (0.13 g, 0.43 mmol, 65 %) as a yellow solid. m. p. 139 °C.

IR (ATR): $\tilde{\nu}$ = 3150 (w, OH), 3087 (w), 1961 (s, CrCO), 1917 (s, CrCO), 1879 (s, CrCO), 1675 (s, NCO), 1541 (w), 1421 (m), 1395 (m), 1247 (w), 1094 (m), 1036 (m), 938 (w), 827 (w), 792 (m), 759 (w) cm⁻¹. – ¹H NMR (400.1 MHz, [D₆] acetone, HMQC): δ = 2.94 (s, 3H, 8-H), 5.63-5.70 (m, 2H, 5(6)-H), 5.96 (m, 2H, 3(7)-H), 6.06 (m, 2H, 4-H, OH) ppm. – ¹³C NMR (100.6 MHz, [D₆] acetone): δ = 26.1 (–, C-8), 81.1 (–, C-3), 86.9 (–, C-7), 89.9 (–, C-4), 92.4 (–, C-5), 93.8 (–, C-6), 98.9 (+, C-7a), 115.5 (+, C-3a), 165.8 (+, C-1), 232.7 (+, C-9) ppm. – MS (70 eV): m/z (%) = 299 (31) [M⁺], 243 (10) [M⁺ – 2CO], 215 (66) [M⁺ – 3CO], 213 (11) [M⁺ – 3CO – 2H],], 198 (10) [M⁺ – 3CO – OH], 197 (11) [M⁺ – 3CO – H₂O], 187 (66) [M⁺ – 4CO], 163 (15) [M⁺ – Cr(CO)₃], 162 (15) [M⁺ – Cr(CO)₃ – H], 164 (100) [M⁺ – Cr(CO)₃ – OH], 118 (28), 91 (37), 77 (26), 52 (74) [Cr]. – HRMS C₁₂H₉ Cr NO₅: calcd. 298.9886, found. 298.9889.

Elemental analyses: calcd. C, 48.17; H, 3.03; N, 4.68, found: C, 48.57; H, 3.14; N, 4.76.

4.4 Tricarbonyl (3-hydroxy-3-methyl-2-phenyl-2,3-dihydroisoindol-1-one)chromium(0)
(155)

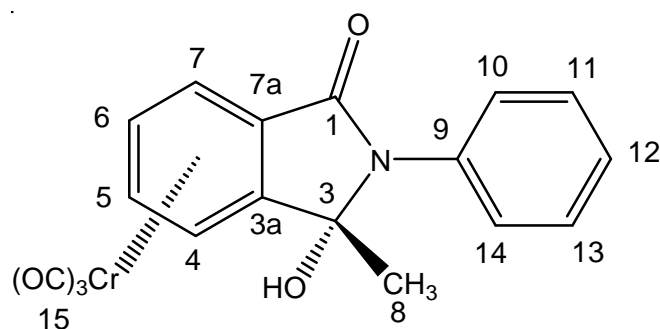

155

GP3, (0.30 g, 0.8 mmol) of **101** in THF (30 mL), methyl magnesium chloride (3M in THF) (0.6 mL, 1.6 mmol), was stirred for 10 h, extracted with ethyl acetate (3 x 20 mL), purified by column chromatography (200 x 20 mm, ethyl acetate), gave **155** (0.24 g, 0.64 mmol, 78 %) as a yellow solid. m.p 148 °C.

IR (ATR): $\tilde{\nu}$ = 3400 (w, OH), 3070 (w), 1963 (s, CO), 1958 (s, CO), 1889 (s, CO), 1700 (s, CO), 1499 (m), 1383 (m), 1217 (w), 1112 (w), 1069 (w), 879 (w), 848 (w), 760 (w) cm^{-1} . – ^1H NMR (400.1 MHz, $[\text{D}_6]$ acetone, HMQC): δ = 1.73 (s, 3H, 8-H), 5.72 (s, 1H, 6-H), 5.94 (s, 1H, 5-H), 6.00 (m, 1H, 4-H), 6.11 (s, 1H, OH), 6.45 (s, 1H, 7-H) 7.4 [m, 5H, (9-13)-H] ppm. – ^{13}C NMR (100.6 MHz, $[\text{D}_6]$ acetone): δ = 24.7 (–, C-8), 85.5 (–, C-7), 89.1 (+, C-3), 90.5 (–, C-4), 91.4 (–, C-5), 95.3 (–, C-6), 97.1 (+, C-7a), 116.5 (+, C-3a), 123.3 [–, C-12], 127.5 [–, C-11(13)], 128.8 [–, C-10(14)], 132.1 [+ , C-9], 164.8 (+, C-1), 232.2 (+, C-15) ppm. – MS (70 eV): m/z (%) = 375 (0) $[\text{M}^+]$, 274 (4) $[\text{M}^+ - 3\text{CO} - \text{OH}]$, 273 (3) $[\text{M}^+ - 3\text{CO} - \text{H}_2\text{O}]$, 239 (2) $[\text{M}^+ - \text{Cr}(\text{CO})_3]$, 223 (100) $[\text{M}^+ - \text{Cr}(\text{CO})_3 - \text{O}]$, 222 (7) $[\text{M}^+ - \text{Cr}(\text{CO})_3 - \text{OH}]$, 179, 147, 104, 76, 52 [Cr]. – HRMS $\text{C}_{18}\text{H}_{13}\text{CrNO}_5$: calcd. 375.0199, found.

Elemental analyses: calcd. C, 57.61; H, 3.49; N, 3.73, found: C, 57.85; H, 3.34; N, 3.86.

4.5 Tricarbonyl [2-(2-bromo-ethyl)-3-hydroxy-3-methyl-2,3-dihydro-isoindol-1-one] chromium(0) (**156**)

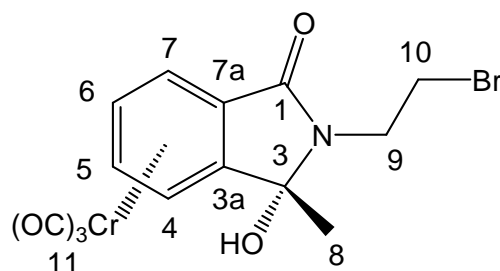

156

GP3, (0.30 g, 0.8 mmol) of **81** in THF (30 mL), methyl magnesium chloride (3M in THF) (0.5 mL, 1.5 mmol), was stirred at $-78\text{ }^{\circ}\text{C}$ for 10 h, extracted with ethyl acetate (3 x 20 mL), purified by column chromatography (200 x 20 mm, ethyl acetate), gave **156** (0. g, 0. mmol, %) as a yellow solid. m.p $128\text{ }^{\circ}\text{C}$.

IR (ATR): $\tilde{\nu} = 3370\text{ cm}^{-1}$ (br, OH), 2971(w), 1977 (s, CO), 1900 (s, CO), 1878 (s, CO) 1739 (s, NCO), 1542 (w), 1422 (w), 1376 (s), 1226 (m), 1129 (w), 1109 (m), 1090 (m), 949 (m), 806 (w), 774 (w). – ^1H NMR (400.1 MHz, $[\text{D}_6]$ acetone): $\delta = 1.94$ (s, 3H, 8-H), 3.64 (t, $J = 7.9$ Hz, 2H, 10-H), 3.83 (t, $J = 8.0$ Hz, 2H, 9-H), 5.73 [m, 2H, 5(6)-H], 5.93 (m, 2H, 4-H, OH), 6.39 (d, $J = 6.1$ Hz, 1H, 7-H) ppm. – ^{13}C NMR (100.6 MHz, $[\text{D}_6]$ acetone, DEPT): $\delta = 25.5$ (–, C-8), 29.1 (+, C-10), 41.4 (+, C-9), 86.2 (–, C-7), 88.4 (+, C-7a), 91.2, 92.3 [–, C-5(6)], 95.9 (–, C-4), 97.5 (+, C-3), 117.4 (+, C-3a), 166.4 (+, C-1), 232.9 (+, C-11) ppm. – MS (70 eV): m/z (%) = 407, 405 (2), (2) $[\text{M}^+]$, 390, 388 (19), (20) $[\text{M}^+ - \text{OH}]$, 389, 387 (48), (48) $[\text{M}^+ - \text{H}_2\text{O}]$, 351, 349 (3), (3) $[\text{M}^+ - 2\text{CO}]$, 333, 331 (15), (15) $[\text{M}^+ - 2\text{CO} - \text{H}_2\text{O}]$, 323, 321 (1), (1) $[\text{M}^+ - 3\text{CO}]$, 305, 303 (11), (11) $[\text{M}^+ - 3\text{CO} - \text{H}_2\text{O}]$, 295, 293 (4), (4) $[\text{M}^+ - 4\text{CO}]$, 277, 275 (99), (100) $[\text{M}^+ - 4\text{CO}]$, 253, 251 (10), (9) $[\text{M}^+ - \text{Cr}(\text{CO})_3 - \text{H}_2\text{O}]$, 196 (65), 172 (41), 158 (22), 77 (12), 52 (60) $[\text{Cr}]$. – HRMS $\text{C}_{14}\text{H}_{12}\text{BrCrNO}_5$: calcd. 404.9304, found. 404.9307.

4.6 Tricarbonyl(9b-Methyl-2,3-dihydro-9bH-oxazolo[2,3-a]isoindol-5-one)chromium(0) (157)

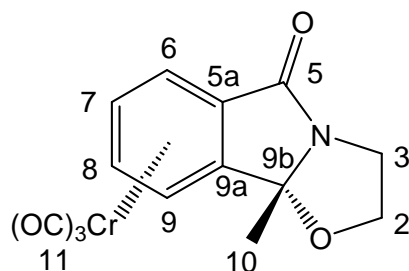

157

GP3, (0.30 g, 0.8 mmol) of **81** in THF (30 mL), methyl magnesium chloride (3M in THF) (0.5 mL, 1.5 mmol), was stirred at 25 °C for 24 h, extracted with ethyl acetate (3 x 20 mL), purified by column chromatography (200 x 20 mm, TBME / PE 1:1), gave **157** (0.12 g, 0.35 mmol, 46 %) as a yellow solid. m.p 107 °C, then ethyl acetate, gave **156** (0.04 g, 0.01 mmol, 13 %).

IR (ATR): $\tilde{\nu}$ = 2931 (w, CH), 1950(s, CrCO), 1889 (s, CrCO), 1865 (s, CrCO), 1709 (s, NCO), 1536 (w), 1413 (m), 1375 (s), 1258 (m), 1142 (m), 1075 (m), 1045 (m), 1019 (m), 909 (w), 883 (w), 798 (m) 695 (m) cm^{-1} . – ^1H NMR (400.1 MHz, $[\text{D}_6]$ acetone): δ = 1.82 (s, 3H, 10-H), 3.51 (m, 1H, NCH₂), 4.08 (m, 2H, OCH₂), 4.26 (m, 1H, NCH₂), 5.77 (m, 1H, 7-H), 5.93 (t, J = 6.1 Hz, 1H, 8-H), 5.95 (d, J = 6.2 Hz, 1H, 9-H), 6.44 (d, J = 6.1 Hz, 1H, 7-H), ppm. – ^{13}C NMR (100.6 MHz, $[\text{D}_6]$ acetone): δ = 20.9 (–, C-10), 42.1 (+, C-3), 68.6 (+, C-2), 86.0, 90.5, 91.9, 95.2 (–, C-6,7,8,9), 95.1 (+, C-9b), 97.0 (+, C-5a), 113.1 (+, C-9a), 165.9 (+, C-5), 231.7 (+, C-11) ppm. – MS (70 eV): m/z (%) = 325 (42) $[\text{M}^+]$, 269 (13) $[\text{M}^+ - 2\text{CO}]$, 241 (66) $[\text{M}^+ - 3\text{CO}]$, 213 (44) $[\text{M}^+ - 4\text{CO}]$, 189 (2) $[\text{M}^+ - \text{Cr}(\text{CO})_3]$, 174 (49) $[\text{M}^+ - \text{Cr}(\text{CO})_3 - \text{CH}_3]$, 147 (27), 130 (36), 102 (11), 77 (21), 52 (100) $[\text{Cr}]$. – HRMS $\text{C}_{14}\text{H}_{11}\text{CrNO}_5$: calcd. 325.0042, found. 325.0039.

Elemental analyses: calcd. C, 51.70; H, 3.41; N, 4.31, found: C, 51.85; H, 3.24; N, 4.26.

4.7 Synthesis of tricarbonyl(2,3-dimethyl-3-methoxy-2,3-dihydro-isoindol-1-one) chromium(0) (158)

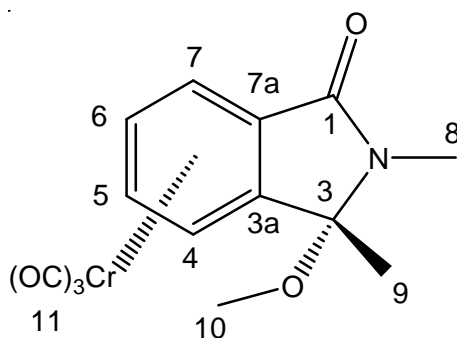

158

To a cooled solution of **149** (0.30 g, 1.0 mmol) in THF (40 mL) at -78°C was added NaH (0.03 g, 1.3 mmol), then methyl iodide (0.18 g, 1.3 mmol) at -78°C , stirring for 4 h, evaporate solvent, diluted with water, then extracted three times with ethyl acetate, purified by column chromatography (200 x 20 mm, TBME), yield product **158** (0.23 g, 0.7 mmol, 73 %) as a yellow solid. m. p. 114°C ,

IR (ATR): $\tilde{\nu} = 2930$ (w, CH), 1957(s, CrCO), 1892 (s, CrCO), 1863 (s, CrCO), 1709 (s, NCO), 1536 (w), 1416 (m), 1375 (s), 1257 (m), 1142 (m), 1075 (m), 1045 (m), 1019 (m), 909 (w), 880 (w), 798 (m) 694 (m) cm^{-1} . – ^1H NMR (400.1 MHz, $[\text{D}_6]$ acetone, HMQC): $\delta = 1.80$ (s, 3H, 9-H), 2.79 (s, 3H, 10-H), 2.86 (s, 3H, 8-H), 5.66 (t, $J = 5.9$ Hz, 1H, 6-H), 5.93 (m, 2H, 4(5)-H), 6.33 (d, $J = 6.3$ Hz, 1H, 7-H), ppm. – ^{13}C NMR (100.6 MHz, $[\text{D}_6]$ acetone): $\delta = 23.82$ (–, C-8), 24.91 (–, C-9), 49.75 (–, C-10), 85.76 (–, C-4), 91.60 (–, C-7), 91.75 (–, C-5), 91.77(+, C-3), 96.17 (–, C-6), 99.11 (+, C-7a), 113.24 (+, C-3a), 165.81 (+, C-1), 232.74 (+, C-11) ppm. – MS (70 eV): m/z (%) = 327 (11) $[\text{M}^+]$, 296 (5) $[\text{M}^+ - \text{CH}_3\text{O}]$, 295 (9) $[\text{M}^+ - \text{CH}_3\text{OH}]$, 271 (4) $[\text{M}^+ - 2\text{CO}]$, 243 (28) $[\text{M}^+ - 3\text{CO}]$, 212 (19) $[\text{M}^+ - 3\text{CO} - \text{CH}_3\text{O}]$, 211 (70) $[\text{M}^+ - 3\text{CO} - \text{CH}_3\text{OH}]$, 160 (82) $[\text{M}^+ - \text{Cr}(\text{CO})_3 - \text{CH}_3\text{O}]$, 159 (23) $[\text{M}^+ - \text{Cr}(\text{CO})_3 - \text{CH}_3\text{OH}]$, 130 (27), 103 (15) 91 (13), 77 (22), 52 (100) $[\text{Cr}]$. – HRMS $\text{C}_{14}\text{H}_{13}\text{CrNO}_5$: calcd. 327.0199, found. 327.0202.

4.8 Synthesis of tricarbonyl (2-methyl-3-methylene-2,3-dihydro-isoindol-1-one) chromium(0) (162**)**

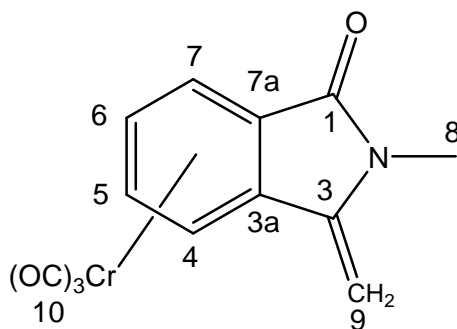

162

To a cooled solution of **149** (0.20 g, 0.67 mmol) in THF (30 mL) at -78°C was added (2 mL) of $\text{BF}_3\text{-O}(\text{Et})_2$ (48 % BF_3) at -78°C , stirring for 10 hrs, evaporate solvent, diluted with water, then extracted three times with ethyl acetate, purified by column chromatography (200 x 20 mm, TBME / PE 4:1), yield product **162** (0.10 g, 0.34 mmol, 53 %) as a orange solid. m. p. 85°C .

IR (ATR): $\tilde{\nu} = 3095$ (w, $=\text{CH}_2$), 1965(s, CrCO), 1889 (s, CrCO), 1703 (s, NCO), 1642 (s), 1532 (w), 1433 (m), 1381 (m), 1302 (w), 1080 (m), 1029 (m), 841 (w), 770 (w), 697 (m) cm^{-1} ,. ^1H NMR (400.1 MHz, CDCl_3 , HMQC): $\delta = 3.23$ (s, 3H, 8-H), 4.88 (d, $J = 2.5$ Hz, 1H, 9-H), 5.04 (d, $J = 2.6$ Hz, 1H, 9-H), 5.30 (t, $J = 6.5$ Hz, 1H, 6-H), 5.60 (t, $J = 6.5$ Hz, 1H, 5-H), 5.81 (d, $J = 6.3$ Hz, 1H, 4-H), 6.14 (d, $J = 6.3$ Hz, 1H, 7-H) ppm. ^{13}C NMR (100.6 MHz, CDCl_3): $\delta = 26.3$ (-, C-8), 82.6 (-, C-4), 88.4 (-, C-7), 88.8 (-, C-6), 89.4 (+, C-9), 90.5 (+, C-7a), 93.2 (-, C-5), 102.0 (+, C-3a), 141.2 (+, C-3), 165.3 (+, C-1), 230.6 (+, C-10) ppm. – MS (70 eV): m/z (%) = 295 (18) [M^+], 239 (11) [$\text{M}^+ - 2\text{CO}$], 211 (89) [$\text{M}^+ - 3\text{CO}$], 159 (100) [$\text{M}^+ - \text{Cr}(\text{CO})_3$], 131 (15) [$\text{M}^+ - 4\text{CO}$], 130 (78) [$\text{M}^+ - \text{Cr}(\text{CO})_3 - \text{H}$], 116 (11) [$\text{M}^+ - \text{Cr}(\text{CO})_3 - \text{CH}_3$], 103 (17), 90 (17), 77 (19), 52 (90) [Cr]. – HRMS $\text{C}_{13}\text{H}_9\text{CrNO}_5$: calcd. 294.9937, found. 294.9935. Elemental analyses: calcd. C, 52.89; H, 3.07; N, 4.74, found: C, 52.57; H, 2.97; N, 4.82.

4.9 Tricarbonyl(2,3-dimethyl-2,3-dihydro-isoindol-1-one)Chromium(0) (**169**)

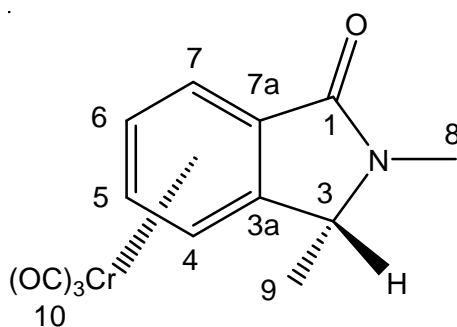

169

To a cooled solution of **149** (0.40 g, 1.28 mmol) in THF (40 mL) at -78°C was added triethylsilane (1 mL), then (1 mL) of $\text{BF}_3\text{-O}(\text{Et})_2$ (48 % BF_3) at -78°C , stirring for 8 h, evaporate solvent, diluted with water, then extracted three times with ethyl acetate, purified by column chromatography (200 x 20 mm, TBME / PE 2:1), yield product **169** (0.23 g, 0.77 mmol, 61 %) as a yellow solid. m. p. 134°C , and **162** (11 %) with (TBME / PE 4:1).

IR (ATR): $\tilde{\nu} = 3058$ (w, CH), 1964(s, CrCO), 1871 (s, CrCO), 1688 (s, NCO), 1551 (w), 1424 (m), 1394 (s), 1261 (m), 1150 (m), 1066 (m), 831 (w), 771 (m) cm^{-1} . – ^1H NMR (400.1 MHz, $[\text{D}_6]$ acetone, HMQC, HMBC): $\delta = 1.60$ (d, $J = 6.5$ Hz, 3H, 9-H), 3.01 (s, 3H, 8-H), 4.64 (q, $J = 6.1$ Hz, 1H, 3-H), 5.62 (t, $J = 6.1$ Hz, 1H, 5-H), 5.84 (t, $J = 6.0$ Hz, 1H, 6-H), 5.90 (d, $J = 5.9$ Hz, 1H, 4-H), 6.29 (d, $J = 6.1$ Hz, 1H, 7-H), ppm. – ^{13}C NMR (100.6 MHz, $[\text{D}_6]$ acetone, HMBC): $\delta = 18.6$ (–, C-9), 26.3 (–, C-8), 55.9 (–, C-3), 85.4 (–, C-4), 90.6 (–, C-7), 91.1 (–, C-5), 95.0 (–, C-6), 100.0 (+, C-7a), 117.3 (+, C-3a), 165.8 (+, C-1), 233.0 (+, C-10) ppm. – MS (70 eV): m/z (%) = 297 (26) $[\text{M}^+]$, 241 (8) $[\text{M}^+ - 2\text{CO}]$, 213 (96) $[\text{M}^+ - 3\text{CO}]$, 161 (43) $[\text{M}^+ - \text{Cr}(\text{CO})_3]$, 146 (100) $[\text{M}^+ - \text{Cr}(\text{CO})_3 - \text{CH}_3]$, 130 (15), 103 (17), 91 (30), 77 (22), 76 (11), 52 (89) [Cr]. – HRMS $\text{C}_{13}\text{H}_{11}\text{CrNO}_4$: calcd. 297.0093, found. 297.0093.

4.10 Optically active tricarbonyl (3-hydroxy-2-methyl-2,3-dihydroisindol-1-one) chromium(0) (188**)**

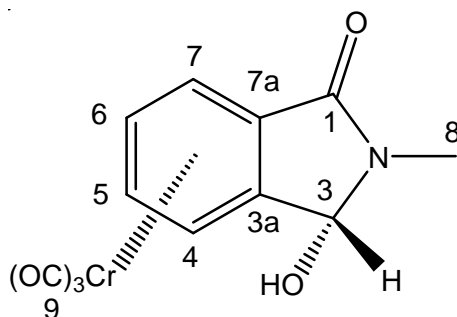

188

Complex **78** (0.55 g, 1.85 mmol) in THF (3 mL) was added by syringe to a pre-stirred solution (15 min) of catalyst **180** (10 mol %, from a 1.0 M solution in THF, 0.18 mL, 0.18 mmol)^[185] and BH₃·THF (1.0 M solution, 1.85 mL, 1.85 mmol) at 0°C and left to stir at this temperature for 30 min.. The reaction was then quenched with 5% HCl and the aqueous layer was extracted into CH₂Cl₂ (2×25 mL). The combined organic extracts were dried over MgSO₄, filtered and the solvent removed under reduced pressure, purified by column chromatography (200 x 20 mm, ethyl acetate), yield to give **188** (0.37 g, 1.24 mmol, 67 %) as a yellow solid. m. p. 149 °C.

IR (ATR): $\tilde{\nu}$ = 3310 (w, OH), 3087 (w), 1961 (s, CrCO), 1917 (s, CrCO), 1879 (s, CrCO), 1675 (s, NCO), 1541 (w), 1421 (m), 1395 (m), 1247 (w), 1094 (m), 1036 (m), 938 (w), 827 (w), 792 (m), 759 (w) cm⁻¹. – ¹H NMR (400.1 MHz, [D₆] acetone, HMQC): δ = 2.94 (s, 3H, 8-H), 5.63-5.70 (m, 2H, 5(6)-H), 5.96 (m, 2H, 3(7)-H), 6.06 (m, 2H, 4-H, OH) ppm. – ¹³C NMR (100.6 MHz, [D₆] acetone): δ = 26.1 (–, C-8), 81.1 (–, C-3), 86.9 (–, C-4), 89.9 (–, C-7), 92.4 (–, C-5), 93.8 (–, C-6), 98.9 (+, C-7a), 115.5 (+, C-3a), 165.8 (+, C-1), 232.7 (+, C-9) ppm. – MS (70 eV): m/z (%) = 299 (31) [M⁺], 243 (10) [M⁺ – 2CO], 215 (66) [M⁺ – 3CO], 213 (11) [M⁺ – 3CO – 2H],], 198 (10) [M⁺ – 3CO – OH], 197 (11) [M⁺ – 3CO – H₂O], 187 (66) [M⁺ – 4CO], 163 (15) [M⁺ – Cr(CO)₃], 162 (15) [M⁺ – Cr(CO)₃ – H], 164 (100) [M⁺ – Cr(CO)₃ – OH], 118 (28), 91 (37), 77 (26), 52 (74) [Cr]. – HRMS C₁₂H₉ Cr NO₅: calcd. 298.9886, found. 298.9889.

4.11 Optically active tricarbonyl (3-hydroxy-2-ethyl-2,3-dihydroisoindol-1-one) chromium(0) (189**)**

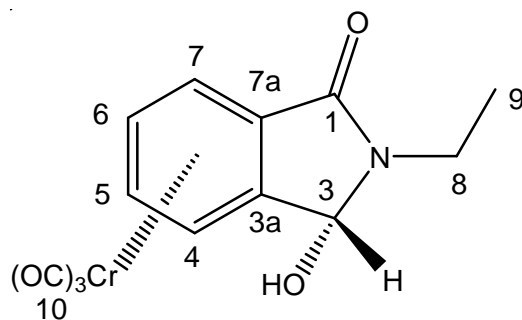

189

Complex **79** (0.35 g, 1.12 mmol) in THF (3 mL) was added by syringe to a pre-stirred solution (15 min) of catalyst **180** (10 mol %, from a 1.0 M solution in THF, 0.11 mL, 0.11 mmol) and $\text{BH}_3\cdot\text{THF}$ (1.0 M solution, 1.12 mL, 1.12 mmol) at 0°C and left to stir at this temperature for 30 min.. The reaction was then quenched with 5% HCl and the aqueous layer was extracted into CH_2Cl_2 (2×25 mL). The combined organic extracts were dried over MgSO_4 , filtered and the solvent removed under reduced pressure, purified by column chromatography (200 x 20 mm, ethyl acetate), yield to give **189** (0.23 g, 0.73 mmol, 66 %) as a yellow solid. m. p. 113°C .

IR (ATR): $\tilde{\nu} = 3350$ (w, OH), 3080 (w), 1964 (s, CrCO), 1912 (s, CrCO), 1868 (s, CrCO), 1679 (s, NCO), 1541 (w), 1421 (m), 1394 (m), 1247 (w), 1090 (m), 938 (w), 837 (w), 792 (m), 759 (w) cm^{-1} . – ^1H NMR (400.1 MHz, $[\text{D}_6]$ acetone, HMQC): $\delta = 1.20$ (t, $J = 7.1$ Hz, 3H, 9-H), 3.38 (m, 1H, 8-H), 3.60 (m, 1H, 8-H), 5.64 (t, $J = 5.5$ Hz, 1H, 5(6)-H), 5.70 (t, $J = 6.2$ Hz, 1H, 5(6)-H), 5.94 (d, $J = 6.1$ Hz, 1H, 4-H), 6.01 (m, 3H, 3(7)-H, OH) ppm. – ^{13}C NMR (100.6 MHz, $[\text{D}_6]$ acetone): $\delta = 12.9$ (–, C-9), 34.0 (+, C-8), 78.8 (–, C-3), 86.1 (–, C-4), 89.4 (–, C-7), 91.6 (–, C-5), 93.1 (–, C-6), 98.3 (+, C-7a), 114.8 (+, C-3a), 164.9 (+, C-1), 232.1 (+, C-10) ppm. – MS (70 eV): m/z (%) = 313 (37) [M^+], 296 (5) [$\text{M}^+ - \text{OH}$], 275 (14) [$\text{M}^+ - 2\text{CO}$], 229 (75) [$\text{M}^+ - 3\text{CO}$], 211 (57) [$\text{M}^+ - 3\text{CO} - \text{H}_2\text{O}$], 201 (80) [$\text{M}^+ - 4\text{CO}$], 177 (15) [$\text{M}^+ - \text{Cr}(\text{CO})_3$], 160 (100) [$\text{M}^+ - \text{Cr}(\text{CO})_3 - \text{OH}$], 132 (66), 104 (21), 91 (15), 77 (37), 52 (93) [Cr]. – HRMS $\text{C}_{13}\text{H}_{11}\text{CrNO}_5$: calcd. 313.0042, found. 313.0040.

Elemental analyses: calcd. C, 49.85; H, 3.54; N, 4.47, found: C, 49.57; H, 3.34; N, 4.36.

References

- [1] *Transition Metal Arene π -Complexes in Organic Synthesis and Catalysis* (Topics in Organometallic Chemistry, Ed. E. Peter Kündig) **2004**, 7, 3-4.
- [2] W. A. L. Otterlo, C. B. Koning, *Chem. Rev.* **2009**, 109, 3743-3782.
- [3] S. Saito, Y. Yamamoto, *Chem. Rev.*, **2000**, 100, 2901-2916.
- [4] E. J. G. Anctil, V. Snieckus (The Directed ortho - Metallation Cross-Coupling Nexus: Synthetic Methodology for the Formation of Aryl-Aryl and Aryl-Heteroatom-Aryl Bonds, Ed(s): A. De Meijere, F. Diederich) *Metal-Catalyzed Cross-Coupling Reactions* (2nd Edition) **2004**, 2, 761-813.
- [5] A. V. Kalinin, A. J. M. Silva, C. C. Lopes, R. S. C. Lopes, V. Snieckus, *Tetrahedron Lett.* **1998**, 39, 4995-4998.
- [6] K. H. Dötz, B. Wenzel, H. C. Jahr, *Topics in Current Chemistry* (Templates in Chemistry I, Vol. Ed(s) C. A. Schalley, F. Vögtle, K. H. Dötz) **2004**, 248, 63-103.
- [7] A. Kotschy, G. Timári (*Heterocycles from Transition Metal Catalysis: Formation and Functionalization*) **2005**, 19-62.
- [8] M. A. Esteruelas, A. Lledos, M. Olivan, E. Onate, M. A. Tajada, G. Ujaque, *Organometallics* **2003**, 22, 3753-3765.
- [9] a) E. O. Fischer, K. Öfele, *Chem. Ber.* **1957**, 90, 2532-2535; b) E. O. Fischer, *Angew. Chem.* **1957**, 69, 715-716.
- [10] B. Nicholls, M. C. Whiting, *Proc. Chem. Soc.* **1958**, 152-153.
- [11] G. Natta, R. Ercoli, F. Calderazzo, *Chim. Ind.* **1958**, 40, 287-289.
- [12] E. O. Fischer, *Chem. Coord. Compds., Symp. Rome* **1958**, 268-272.
- [13] A. R. Pape, K. P. Kaliappan, E. P. Kündig, *Chem. Rev.* **2000**, 100, 2917-2940.
- [14] *Comprehensive Organometallic Chemistry II* (Eds.: E.W. Abel, F. G. A. Stone, G. Wilkinson) Pergamon, New York, **1995**, vol. 12, pp. 979-1038.
- [15] M. F. Semmelhack, *J. Organomet. Chem.* **1976**, 1, 361-395.
- [16] R. S. Cahn, C. Ingold, V. Prelog, *Angew. Chem.* **1966**, 78, 413-447; *Angew. Chem. Int. Ed. Engl.* **1966**, 5, 385-419.
- [17] C. A. L. Mahaffy, P. L. Pauson, *Inorg. Syntheses* **1990**, 28, 136-140.

References

- [18] H. G. Wey, P. Betz, H. Butenschön, *Chem. Ber.* **1991**, *124*, 465-474.
- [19] H.G. Wey, P. Betz, I. Topalovic, H. Butenschön, *J. Organomet. Chem.* **1991**, *411*, 369-374.
- [20] D. Leinweber, R. Wartchow, H. Butenschön, *Eur. J. Org. Chem.* **1999**, 167-179.
- [21] D. Leinweber, I. Weidner, R. Wilhelm, R. Wartchow, H. Butenschön, *Eur. J. Org. Chem.* **2005**, 5224-5235.
- [22] Z. Zhao, J. Messinger, U. Schön, R. Wartchow, H. Butenschön, *Chem. Commun.* **2006**, 3007-3009
- [23] B. Muschalek, I. Weidner, H. Butenschön, *J. Organomet. Chem.* **2007**, *692*, 2415-2424.
- [24] C. Kayran, S. Ozkar, *Z. Naturforsch., B.* **1992**, *47*, 1051-1053.
- [25] J. Vebrel, R. Mercier, J. Belleney, *J. Organomet. Chem.* **1982**, *235*, 197-200.
- [26] J. A. Morley, N. F. Woolsey, *J. Org. Chem.* **1992**, *57*, 6487-6495
- [27] M. Brands, H. G. Wey, R. Krömer, C. Krüger, H. Butenschön, *Liebigs Ann.* **1995**, 253-265.
- [28] G. R. Knox, D. G. Leppard, P. L. Pauson, W. E. Watts, *J. Organomet. Chem.* **1972**, *34*, 347-352.
- [29] K. Öfele, E. Dotzauer, *J. Organomet. Chem.* **1971**, *30*, 211-220.
- [30] J. Tweddell, D. A. Hoic, G. C. Fu., *J. Org. Chem.* **1997**, *62*, 8286-8287.
- [31] K. Öfele, *Chem. Ber.* **1966**, *99*, 1732-1736.
- [32] E. P. Kündig, C. Perret, S. Spichiger, G. Bernardinelli, *J. Organomet. Chem.* **1985**, *286*, 183-200.
- [33] M. Uemura, T. Kobayashi, K. Isobe, T. Minami, Y. J. Hayashi, *Org. Chem.* **1986**, *51*, 2859-2863.
- [34] H. G. Schmalz, B. Millies, J. W. Bats, G. Dürner, *Angew. Chem.* **1992**, *104*, 640-643, *Angew. Chem., Int. Ed. Engl.* **1992**, *31*, 631-633.
- [35] A. Alexakis, P. Mangeney, I. Marek, F. Rose-Munch, E. Rose, A. Semra, F. Robert, *J. Am. Chem. Soc.* **1992**, *114*, 8288-8290.
- [36] Y. Kondo, J. R. Green, J. Ho, *J. Org. Chem.* **1993**, *58*, 6182-6189.
- [37] M. Uemura, R. Miyake, K. Nakayama, M. Shiro, Y. Hayashi, *J. Org. Chem.* **1993**, *58*, 1238-1244.
- [38] E. P. Kündig, J. Leresche, L. Saudan, G. Bernardinelli, *Tetrahedron* **1996**, *52*, 7363-7378.
- [39] A. Fretzen, A. Ripa, R. Liu, G. Bernardinelli, E. P. Kündig, *Chem. Eur. J.* **1998**, *4*, 251-259.

References

- [40] W. Strohmeier, H. Z. Mittnacht, *Phys. Chem.* **1961**, 29, 339-346.
- [41] W. Strohmeier, E. H. Z. Staricco, *Phys. Chem.* **1963**, 38, 315-325.
- [42] G. Natta, R. Ercoli, F. Calderazzo, E. Santambrogio, *Chim. Ind.* **1958**, 40, 1003-1007.
- [43] T. G. Traylor, K. J. Stewart, M. J. Goldberg, *J. Am. Chem. Soc.* **1984**, 106, 4445-4454.
- [44] T. G. Traylor, K. J. Stewart, M. J. Goldberg, *Organometallics* **1986**, 5, 2062-2067.
- [45] T. G. Traylor, K. Stewart, *Organometallics* **1984**, 3, 325-327.
- [46] J. A. S. Howell, N. F. Ashford, D. T. Dixon, J. C. Kola, T. A. Albright, S. K. Kang, *Organometallics* **1991**, 10, 1852-1864.
- [47] C. A. L. Mahaffy, P. L. J. Pauson, *J. Chem. Res., Synop.* **1979**, 126-127.
- [48] C. L. Zimmerman, S. L. Shaner, S. A. Roth, B. R. Willeford, *J. Chem. Res., Synop.* **1980**, 108.
- [49] S. L. Mukerjee, R. F. Lang, T. Ju, G. Kiss, C. D. Hoff, *Inorg. Chem.* **1992**, 31, 4885-4889.
- [50] D. L. S. Brown, J. A. Connor, C. P. Demain, M. L. Leung, J. A. Martinho-Simoes, H. A. Skinner, M. T. Z. Moattar, *J. Organomet. Chem.* **1977**, 142, 321-335.
- [51] F. A. Adedeji, D. L. S. Brown, J. A. Connor, M. L. Leung, I. M. Paz-Andrade, H. A. Skinner, *J. Organomet. Chem.* **1975**, 97, 221-228.
- [52] a) K. H. Dötz, H. Fischer, P. Hofmann, F. R. Kreissl, U. Schubert, K. Weiß, *Transition Metal Carbene Complexes*, Verlag Chemie, Weinheim **1983**; b) F. J. Brown, *Prog. Inorg. Chem.* **1980**, 27, 1-122.
- [53] E. O. Fischer, *Angew. Chem.* **1974**, 86, 651-682.
- [54] O. S. Mills, A. D. Redhouse, *J. Chem. Soc. A* **1968**, 642-647.
- [55] K. H. Dötz, *Pure Appl. Chem.* **1983**, 55, 1689-1706.
- [56] K. H. Dötz, W. Kuhn, *J. Organomet. Chem.* **1983**, 252, 78-80.
- [57] K. H. Dötz, *Angew. Chem.* **1975**, 87, 672-673.
- [58] K. H. Dötz, R. Dietz, *Chem. Ber.* **1977**, 110, 1555-1563.
- [59] K. H. Dötz, J. Miihlemeier, U. Schubert, O. Orama, *J. Organomet. Chem.* **1983**, 247, 187-201.
- [60] K. H. Dötz, R. Dietz, *Chem. Ber.* **1978**, 111, 2517-2526.
- [61] L. M. Lima, P. Castro, A. L. Machado, C. Alberto M. Fraga, C. Lugnier, V. L. G. Moraes, E. J. Barreiro, *Bioorg. & Med. Chem.* **2002**, 10, 3067-3073.
- [62] J. Vamecq, P. Bac, C. Herrenknecht, P. Maurois, P. Delcourt, J. P. Stables *J. Med. Chem.* **2000**, 43, 1311-1319.
- [63] F. A. Luzzio, D. Piatt Zacherl, *Tetrahedron Lett.* **1998**, 39, 2285-2288.

References

- [64] J. B. Campbell, R. F. Dedinas, S. A. Walsh *J. Org. Chem.* **1996**, *61*, 6205-6211.
- [65] B. Decroix, P. Pigeon, M. Othman, *Tetrahedron* **1997**, *53*, 2495-2504.
- [66] S. M. Allin, C. J. Northfield, M. I. Page, A. M. Z. Slawin, *Tetrahedron Lett.* **1997**, *38*, 3627-3630.
- [67] M. S. Kitching, W. Clegg, M. R. J. Elsewood, R. J. Griffin, B. T. Golding *Synlett.* **1999**, 997-999.
- [68] V. Bailleux, L. Vallee, J. P. Nuyts, J. Vamecq, *J. Chem. Pharm. Bull.* **1994**, *42*, 1817.
- [69] M. K. Hargreaves, J. G. Pritchard, H. R. Dave, *Chem. Rev.* **1970**, 439-469.
- [70] Y. Shibata, K. Sasaki, Y. Hashimoto, S. Iwasaki, *J. Chem. Pharm. Bull.* **1996**, *44*, 156.
- [71] S. Blicq, P. M. Danze, V. Dumur, P. Formstecher, M. Dautrevaux, *Biochem.* **1988**, *27*, 8436-8442.
- [72] S. B. Mhaske, N. P. Argade, *Synthesis* **2003**, 863-870.
- [73] S. Chandrasekhar, M. B. Padmajy, A. Raza, *Synlett.* **1999**, 1597-1599.
- [74] E. Valencia, I. Weiss, S. Firdous, A. J. Freyer, M. Shamma, A. Urzua, V. Fayardo, *Tetrahedron* **1984**, *40*, 3957-3962.
- [75] P. Pigeon, B. Decroix, *Tetrahedron Lett.* **1996**, *37*, 7707-7710.
- [76] A. Couture, E. Deniau, P. Grandclaoudon, *Tetrahedron* **1997**, *53*, 10313-10330.
- [77] A. Couture, E. Deniau, P. Grandclaoudon, C. Hoarau, *J. Org. Chem.* **1998**, *63*, 3128-3132.
- [78] A. Couture, E. Deniau, P. Grandclaoudon, C. Hoarau, *Tetrahedron* **2000**, *56*, 1491-1499.
- [79] C. Hoarau, *Tetrahedron* **2000**, *56*, 1491-1499.
- [80] C. Hoarau, A. Couture, E. Deniau, P. Grandclaoudon, *Synthesis* **2000**, 655-660.
- [81] W. Pluempanupat, S. Adisakwattana, S. Yibchok-Anun, W. Chavasiri, *Arch Pharm Res.* **2007**, *30*, 1501-1506.
- [82] G. Nannin, P. N. Griraldi, G. Molgora, G. Biasoli, F. Spinelli, L. Loggemann, E. Dradi, G. Zanni, A. Buttinoni, R. Tommasini, *Arznei. Forsch.* **1973**, *23*, 1090-1100.
- [83] H.-J. Schmahl, L. Denker, C. Plum, I. Chahoud, H. Nau, *Arch. Toxicol.* **1996**, *11*, 749-756.
- [84] J. Plowman, K. D. Paull, G. Atassi, S. Harrison, D. Dykes, N. Kabbe, V. L. Narayan, O. Yoder, *Invers. New. Drugs* **1988**, *6*, 147.
- [85] J. R. Fuchs, R. L. Funk, *Org. Lett.* **2001**, *3*, 3923-3925.
- [86] a) Z. Hussein, D. J. Mulford, B. A. Bopp, G. R. Granneman, *Br. J. Clin. Pharmacol.* **1993**, *36*, 357-361; b) T. Kondo, K. Yoshida, M. Yamamoto, S. Tanayama, *Arznei. Forsch.* **1996**, *46*, 11-14.

References

- [87] T. R. Belliotti, W. A. Brink, S. R. Kesten, J. R. Rubin, D. J. Wustrow, K. T. Zoski, S. Z. Whetzel, A. E. Corbin, T. A. Pugsley, T. G. Heffner, L. D. Wise, *Bioorg. Med. Chem. Lett.* **1998**, *8*, 1499-1502.
- [88] H. McAlonan, J. P. Murphy, M. Nieuwenhuyzen, K. Reynolds, P. K. S. Sarma, P. J. Stevenson, N. J. Thompson, *J. Chem. Soc. Perkin Trans. 1* **2002**, 69-79.
- [89] S. M. Allin, C. J. Northfield, M. I. Page, A. M. Z. Slawin, *J. Chem. Soc. Perkin Trans. 1* **2000**, 1715-1721.
- [90] E. Deniau, D. Enders, A. Couture, P. Grandclaudeon *Tetrahedron Asymm.* **2003**, *14*, 2253-2258.
- [91] R. P. Kreher, H. Hennige, M. Konrad, J. Uhrig, A. Z. Clemens, *Naturforsch. B* **1991**, *46*, 809-828; b) E. Deniau, D. Enders *Tetrahedron Lett.* **2000**, *41*, 2347-2350.
- [92] C. Bianchini, A. Meli, F. Vizza, *Eur. J. Inorg. Chem.* **2001**, 43-68.
- [93] A. Hameed, A. Rbarczyk-Pirek, J. Zakrzewski, *J. Organomet. Chem.* **2002**, *656*, 102-107.
- [94] J. Fornies, M. Green, J. L. Spencer, F. G. A. Stone, *J. Chem. Soc. Dalton Trans.* **1977**, 1006-1009.
- [95] C. López, G. Barón, A. Arévalo, M. A. Muñoz-Hernández, J. J. García, *J. Organomet. Chem.* **2002**, *664*, 170-175.
- [96] C. López, M. A. Muñoz-Hernández, D. Morales-Morales, F. del Rio, S. Hernández-Ortega, R. A. Toscano. J. J. García, *J. Organomet. Chem.* **2003**, *672*, 58-65.
- [97] J. Brocard, L. Pelinski, J. Lebib, M. Mahmoudi, L. Maciejewski, *Tetrahedron* **1989**, *45*, 709-720.
- [98] Z. Zhao, Dissertation, Universität Hannover, **2006**.
- [99] C. Graebe, A. Pictet. *Chem. Ber.* **1884**, *17*, 1173-1175.
- [100] I. Jeong, W. Lee, S. Goto, S. Sano, M. Shiro, Y. Nagao, *Tetrahedron* **1998**, *54*, 14437-14454.
- [101] N. Baret, J. Dulcere, J. Rodriguez, J. Pons, R. Faure, *Eur. J. Org. Chem.* **2000**, 1507-1516.
- [102] R. G. R. Bacon, A. Karim, *J. Chem. Soc. Perkin Trans. 1* **1973**, 278-280.
- [103] N. Cesari, C. Biancalani, C. Vergelli, V. Piaz, A. Graziano, P. Biagini, C. Ghelardini, N. Galeotti, M. P. Giovannoni, *J. Med. Chem.* **2006**, *49*, 7826-7835.
- [104] J. Matsuo, Y. Tani, Y. Hayakawa, *Chem. Lett.* **2004**, *33*, 464-465.

References

- [105] K. Öfele, E. Dotzauer, *J. Organomet. Chem.* **1971**, *30*, 211-220..
- [106] Y. F. Oprunenko, *Russ. Chem. Rev.* **2000**, *69*, 683-704.
- [107] Y. F. Oprunenko, S. G. Malyugina, Y. A. Ustynyuk, N. A. Ustynyuk, *Izv. Akad. Nauk SSSR Ser. Khim.* **1984**, 2405.
- [108] E. P. Kündig, V. Desorby, C. Grivet, B. Rudolf, S. Spichiger, *Organometallics*, **1987**, *6*, 1173-1180.
- [109] Y. F. Oprunenko, S. G. Malyugina, Y. A. Ustynyuk, N. A. Ustynyuk, D. N. Kravtsov, *J. Organomet. Chem.* **1988**, *338*, 357-368.
- [110] S. D. Cunningham, K. Öfele, B. R. Willeford, *J. Am. Chem. Soc.* **1983**, *105*, 3724-3725.
- [111] Y. F. Oprunenko, I. A. Shaposhnikova, Y. A. Ustynyuk, *Organomet. Chem. USSR* **1991**, *4*, 684.
- [112] Y. F. Oprunenko, N. G. Akhmedov, D. N. Laikov, S. G. Malyugina, V. I. Mstislavsky, V. A. Roznyatovsky, Y. A. Ustynyuk, N. A. Ustynyuk, *J. Organomet. Chem.* **1999**, *583*, 136-145.
- [113] R. U. Kirss, P. M. Treichel, *J. Am. Chem. Soc.* **1986**, *108*, 853-855.
- [114] H. C. Jahr, M. Nieger, K. H. Dötz, *J. Organomet. Chem.* **2002**, *641*, 185-194.
- [115] Y. Oprunenko, S. Malyugina, A. Vasil'ko, K. Lyssenko, C. Elschenbroich, K. Harms, *J. Organomet. Chem.* **2002**, *641*, 208-214
- [116] K. H. Dötz, J. Stendel, Jr., S. Müller, M. Nieger, S. Ketrat, M. Dolg, *Organometallics* **2005**, *24*, 3219-3228.
- [117] J. Pan, J. W. Kampf, A. J. Ashe, *Organometallics* **2006**, *25*, 197-202.
- [118] N. Mooz, A. Mandelbaum, M. Ceis, *Tetrahedron Lett.*, **1965**, *6*, 2087-2100.
- [119] S. Pignataro, F. P. Lossing, *J. Organomet. Chem.* **1967**, *10*, 531-534.
- [120] J. Muller, P. Cosser, *Chem. Ber.* **1964**, *102*, 3314.
- [121] P. E. Gaivoronskii, N. V. Larin, N. I. Sirotkin, A. N. Artemov, N. V. Shushunov, *Russ. Chem. Bull.* **1973**, *22*, 2557-2559.
- [122] H. A. Skinner, *Advan. Organomet. Chem.* **1964**, *2*, 49.
- [123] F. A. Cotton, A. K. Fischer, G. Wilkinson, *J. Am. Chem. Soc.* **1959**, *81*, 800-803.
- [124] J. L. Cotter, R. A. Dine-Hart, *Chem. Comm.*, **1966**, 109-110.
- [125] D. J. Iverson, G. Hunter, J. F. Blount, J. R. Damewood, K. Mislow, *J. Am. Chem. Soc.* **1981**, *103*, 6073-6083.
- [126] J. A. S. Howell, C. J. Beddows, P. J. O'Leary, P.C. Yates, P. McArdle, D. Cunningham, H. E. Gottlieb, *J. Organomet. Chem.* **1997**, *537*, 21-27.

References

- [127] E. M. Campi, B. M. K. Gatehouse, W. R. Jackson, I. D. Rae, M. G. Wong, *J. Chem. Soc., Chem. Commun.* **1984**, 175-176.
- [128] J. F. Blount, G. Hunter, K. Mislow, *J. Chem. Soc., Chem. Commun.* **1984**, 170-172.
- [129] G. Hunter, D. J. Iverson, K. Mislow, J. F. Blount, *J. Am. Chem. Soc.* **1980**, *102*, 5942-5943.
- [130] G. Hunter, T. J. R. Weakley, W. Weissensteiner, *J. Chem. Soc., Dalton Trans.* **1987**, 1545-1550.
- [131] J. A. S. Howell, M. G. Palin, P. McArdle, D. Cunningham, Z. Goldschmidt, H. E. Gottlieb, D. Hezroni-Langerman, *Organometallics* **1993**, *12*, 1694-1701.
- [132] M. Cais, M. Kaftory, K. H. Kohn, D. Tatarsky, *J. Organomet. Chem.* **1979**, *184*, 103-112.
- [133] M. Kaftory, *Acta Crystallogr., Sect. B* **1980**, *36*, 2971.
- [134] V. G. Andrianov, Y. T. Struchkov, N. K. Baranetskaya, V. N. Setkina, D. N. Kursanov, *J. Organomet. Chem.* **1975** *101*, 209-214.
- [135] L. E. Overman, C. E. Owen, G. G. Zipp, *Angew. Chem. Int. Ed.* **2002**, *41*, 3884-3887.
- [136] L. Xie, G. B. Jones, *Tetrahedron Lett.* **2005**, *46*, 3579-3582.
- [137] M. Ansorge, T. J. J. Muller, *J. Organomet. Chem.* **1999**, *585*, 174-178.
- [138] J. L. Eglin, L. T. Smith, *Inorg. Chim. Acta* **2001**, *320*, 198-202.
- [139] T. J. J. Müller, H. J. Lindner, *Chem. Ber.* **1996**, *129*, 607-613.
- [140] G. Jaouen, R. J. Dabard, *Organomet. Chem.* **1974**, *72*, 377-388.
- [141] A. D. Hunter, V. Mozol, S. D. Tsai, *Organometallics* **1992**, *11*, 2251-2262.
- [142] G. B. Jones, B. J. Chapman, J. E. Mathews, *J. Org. Chem.* **1998**, *63*, 2928-2938.
- [143] H. G. Wey, H. Butenschön, *J. Organomet. Chem.* **1988**, *350*, CS-C12.
- [144] L. A. Fedorov, P. V. Petrovskii, E. I. Fedin, G. A. Panosyan, A. A. Tsoj, N. K. Baranetskaya, V.N. Setkina, *J. Organomet. Chem.* **1979**, *182*, 499-510.
- [145] G. Jaouen, *J. Organomet. Chem.* **1989**, *370*, 51-64.
- [146] H. G. Alt, H. E. Engelhardt, *J. Organomet. Chem.* **1988**, *355*, 139-148.
- [147] J. A. Chudek, G. Hunter, R. L. MacKay *J. Chem. Soc. Dalton Trans.* **1990**, 2001-2005.
- [148] D. H. Williams, R. S. Ward, R. G. Cooks, *J. Am. Chem. Soc.* **1968**, *90*, 966-972.
- [149] M. Herberhold, C. R. Jablonski, *Inorg. Chim. Acta* **1973**, *7*, 241-250.
- [150] T. E. Bjtterwolf, *Polyhedron* **1988**, *7*, 1377-1382.
- [151] M. F Semmelhack. Transition Metal Arene Complexes:Nucleophilic Addition. *In Comprehensive Organometallic Chemistry II*, E. W. Abel, F. G. A. Stone, G. Wilkinson, Eds; Pergamon: Oxford, **1995**; *12*, 1002-1004, 1085-1088.

References

- [152] (a), S Ganesh, A Sarkar, *Tetrahedron Lett.* **1991**, 32, 1085- 1088. (b) S Sur, S. Ganesh, V. G Puranik., A. J Sarkar, *Chem. Soc., Perkin Trans. I* **1998**, 977-982.
- [153] (a)S Ganesh,. K. M Sathe, M Nandi, P.Chakrabarti, A. Sarkar, *J. Chem. Soc., Chem. Commun.* **1993**, 224-226. (b) S. Sur, S Ganesh, D. Pal, V. G. Puranik, P. Chakrabarti, A. Sarkar, *J. Org. Chem.* **1996**, 61, 8362-8363.
- [154] E. Piers, P. M. Worster, *J. Am. Chem. Soc.* **1972**, 94, 2897-2898
- [155] G. Jaouen, S. Top, A. Laconi, D. Couturier, J. Brocard, *J. Am. Chem. Soc.* **1984**, 106, 2207-2208.
- [156] S. J. Coote, S. G. Davies, D. Diddlemiss, A. Naylor, *J. Organomet. chem.* **1989**, 379, 81-88.
- [157] M. Uemura, K. Isobe, Y. hayashi, *Tetrahedron Lett.* **1985**, 26, 767-770.
- [158] M. Uemura, K. Isobe, Y. hayashi, *Chem. Lett.* **1985**, 91.
- [159] M. Uemura, K. Isobe, K. Take, Y. hayashi, *J. Org. Chem.* **1983**, 84, 3855-3858.
- [160] G. Jaouen, R. Dabard, *Tetrahedron Lett.* **1971**, 12, 1015-1018.
- [161] G. Jaouen, A. Meyer, *J. Am. Chem. Soc.* **1975**, 97, 4667-4672.
- [162] J. Blagg, S.G.Davies, N. J. Holman, C.A Laughton, B. E. Mobbs, *J. Chem. Soc. Perkin Trans. I* **1986**, 1581-1589.
- [163] M. Uemura, T. Kobayashi, Y. hayashi, *Synthesis*, **1986**, 386-388.
- [164] H. Falk, K. Schlögl, W. Steyrer, *Monatsh. Chem.* **1966**, 97, 1029.
- [165] W. R. Jackson, T. R. B. Mitchell, *J. Chem. Soc. (B)*, **1969**, 1228-1230.
- [166] G. Jaouen, R. Dabard, *C. R. Acad. Sci. Paris Ser. C*, **1969**, 269, 713.
- [167] M. Uemura, K. Take, Y. hayashi, *J. Chem. Soc., Chem. Commun.* **1983**, 858-859.
- [168] A Meyer, G. Jaouen, *J. Chem. Soc., Chem. Commun.* **1974**, 787-788.
- [169] I. Weidner, Dissertation, Universität Hannover, **2004**.
- [170] C J. Wharton, R. Wrigglesworth, *J. Chem. Soc. Perkin Trans. I* **1985**, 809-813.
- [171] P. Aeberli, W. J. Houlihan, *J. Org. Chem.* **1969**, 34, 165-170.
- [172] S. Top, A. Meyer, G. Jaouen, *Tetrahedron Lett.* **1979**, 43, 9163-9165.
- [173] E.-C. Wang, H.-F. Chen, P.-K. Feng, Y.-L. Lin, M.-K. Hsu, *Tetrahedron Lett.* **2002**, 43, 3537-3540.
- [174] I. Y Jeong, W. S. Lee, S. Sano, M. Shiro, Y. Nagao, *Tetrahedron* **1998**, 54, 14437-14454.
- [175] W. F. J. Karstens, M. Stol, F. P. J. T. Rutjes, H. Kooijman, A. L. S. Spek, H. J. Hiemstra, *J. Organomet. Chem.* **2001**, 624, 244-258.
- [176] K. Tanaka, Y. Ohta, K. Fuji, *Tetrahedron Lett.* **1993**, 34, 4071-4074.

References

- [177] K. Tanaka, T. Watanabe, K. Shimamoto, P. Sahakitpichan, K. Fuji, *Tetrahedron Lett.* **1999**, *40*, 6599–6602.
- [178] M. Brands, R. Goddard, H. G. Wey, H. Butenshön, *Angew. Chem., Int. Ed. Engl.* **1993**, *32*, 267-269.
- [179] R. Noyori, *Asymmetric Catalysis in Organic Synthesis*, Wiley, UK, **1994**.
- [180] A. Hirao, S. Itsuno, S. Nakahama, N. Yamazaki, *J. Chem. Soc., Chem. Commun.* **1981**, 315-317.
- [181] E. J. Corey, K. R. Bakshi, S. Shibata, *J. Am. Chem. Soc.* **1987**, *109*, 5551-5553.
- [182] G. Bringmann, T. Pabst, P. Henschel, J. Kraus, K. Peters, E. M. Peters, D. S. Rycroft, J. D. Connolly, *J. Am. Chem. Soc.*, **2000**, *122*, 9127-9133.
- [183] K. Matsuki, H. Inoue, A. Ishida, M. Takeda, *Heterocycles*, **1993**, *36*, 937-940.
- [184] J. Kang, J. W. Lee, J. I. Kim, C. Pyun, *Tetrahedron Lett.* **1995**, *36*, 4265-4268.
- [185] S. Jones, J. C. C. Atherton, *Tetrahedron Asymm.* **2000**, *11*, 4543-4548.
- [186] J. B. P. A. Wijnberg, H. E. Schoemaker, W. N. Speckamp, *Tetrahedron* **1978**, *34*, 179-187.
- [187] J. B. P. A. Wijnberg, H. E. Schoemaker, W. N. Speckamp, *Tetrahedron Lett.* **1974**, *46*, 4073-4076.
- [188] M. D. Barker, Rachel A. Dixon, Simon Jones, Barrie J. Marsh, *Chem. Comm.*, 2008, 2218-2220.
- [189] R. A. Dixon, S. Jones, *Tetrahedron Asymm.* **2002**, *13*, 1115–1119.
- [190] S. M. Nettles, K. Matos, E. R. Burkhardt, D. R. Rouda, J. A. Corella, *J. Org. Chem.* **2002**, *67*, 2970–2976.
- [191] J. A. Dale, D. L. Dull, H. S. Mosher, *J. Org. Chem.*, **1969**, *34*, 2543-2549.
- [192] J. A. Dale, H. S. Mosher, *J. Am. Chem. Soc.* **1973**, *95*, 512-519.
- [193] G. R. Sullivan, J. A. Dale, H. S. Mosher, *J. Org. Chem.* **1973**, *38*, 2143-2147.
- [194] I. Ohtani, T. Kusumi, Y. Kashman, H. Kakisawa, *J. Am. Chem. Soc.* **1991**, *113*, 4092-4096.
- [195] N. S. Simpkins, D. A. Price, A. M. MacLeod, A. P. Watt, *J. Org. Chem.* **1994**, *59*, 1961-1962.

Curriculum Vitae

Personal Data

Name : Osama Mahmoud Ali Habib
Gender : Male
Nationality : Egyptian
Date of Birth : 26.04.1973.
Place of Birth : Libya
Marital Status : Married, three Children
Occupation : Assistant Lecturer in Assiut Uni. Egypt

Qualifications

- **M. Sc. Degree in Chemistry “Organic Chemistry” (2002);**
Thesis Title: “Studies on synthesis of thiazolotriazoles, triazolothiadiazines and some related compounds”.
Place of Graduation: Chemistry Dept. Faculty of Science, Assiut Univ., Egypt.
- **B. Sc. Degree in Science “Chemistry” (1995), Grade: Very Good.**
Place of Graduation: Chemistry Dept. Faculty of Science, Assiut University, Assiut, Egypt.
- **Secondary school, El-monofiya-Egypt (1991).**
- **Primary school, El-monofiya-Egypt (1985).**

Employment History

- PhD student in Hannover University-Germany (february 2007 – march 2010)
- Assistant Lecturer at Chemistry Dept., Assiut University-Egypt (Apr. 2002 till now).
- Demonstrator at Chemistry Dept., Assiut University-Egypt (08.11.1995-24.05.2002).

Publications

1. A. O. A. Sarhan, H. A. H ElSherif, A. M. Mahmoud, O. M. A Habib,” Synthesis, characterization and studies of new 3-benzyl-4H-1,2,4-triazole-5-thiol and thiazolo[3,2-b][1,2,4]triazole-5(6H)-one heterocycles “ Journal of Heterocyclic Chemistry. 2008, 45, 897-907.
2. A. M. Mahmoud, H. A. H. El-Sherif, O. M. A. Habib, A. A. O. Sarhan “Synthesis and Studies of Triazolothiadiazines. An Approach Toward New Biologically Active Heterocyclic Compounds”, Phosphorus, Sulfur and Silicon and the Related Elements 2007, 182, 1757-1766
3. H. A. H. El-Sherif, A. M. Mahmoud, A. A. O. Sarhan, Z. A. Hozien, O. M. A Habib, “One pot synthesis of novel thiazolo[3,2-b][1,2,4]triazoles: A useful synthetic application of the acidified acetic acid method“ Journal of Sulfur Chemistry 2006, 27, 65-85.