

**Total Synthesis of Archazolid A
and
Studies Towards the Total Synthesis of Etnangien**

Von der Naturwissenschaftlichen Fakultät
der Gottfried Wilhelm Leibniz Universität Hannover

zur Erlangung des Grades

Doktor der Naturwissenschaften

- Dr. rer. nat. -

genehmigte Dissertation

von

Diplom-Chemiker Jun Li
geboren am 14. November 1972
in Nei Mongel
China

2008

Referent: Prof. Dr. Markus Kalesse

Koreferent: Prof. Dr. Dirk Menche

Tag der Promotion: 17.12.2008

Erklärung zur Dissertation

Hierdurch erkläre ich, dass die Dissertation:

**Total Synthesis of Archazolid A
and
Studies Towards the Total Synthesis of Etnangien**

selbstständig verfasst und alle benutzten Hilfsmittel sowie evtl. zur Hilfeleistung herangezogene Institutionen vollständig angegeben wurden.

Die Dissertation wurde nicht schon als Diplom- oder ähnliche Prüfungsarbeit verwendet.

Hannover, den 14.10.2008.



(Unterschrift)

Name: Jun Li

Publikationen

1. D. Menche, J. Hassfeld, J. Li, G. Menche, A. Ritter, S. Rudolph;
Hydrogen Bond Catalyzed Direct Reductive Amination of Ketones.
Org. Lett. **2006**, 8, 741-744.
2. D. Menche, J. Hassfeld, J. Li, S. Rudolph;
Total Synthesis of Archazolid A.
J. Am. Chem. Soc. **2007**, 129, 6100-6101.
3. D. Menche, S. Böhm, J. Li, S. Rudolph, W. Zander
Synthesis of hindered tertiary amines by a mild reductive amination procedure.
Tetrahedron Lett. **2007**, 48, 365-369.
4. D. Menche, F. Arikan, J. Li, S. Rudolph
Directed Reductive Amination of β -Hydroxy-Ketones: Convergent Assembly of the Ritonavir/Lopinavir Core.
Org. Lett. **2007**, 9, 267-270.
5. D. Menche, F. Arikan, J. Li, S. Rudolph, F. Sasse
Efficient one-pot synthesis of biologically active polysubstituted aromatic amines.
Bioorg. Med. Chem. **2007**, 15, 7311-7317.
6. F. Arikan, J. Li, D. Menche
Diastereodivergent Aldol Reactions of Chiral Ethyl Ketones: Modular Access to (1,4)-syn and -anti Polypropionates.
Org. Lett. **2008**, 10, 3521-3524.

Wissenschaftlichen Vorträgen

Beiträge zur Totalsynthese von Archazolid: Synthese des Nordwest-Fragmentes
27. Tübingen-Göttinger Gespräche zur Chemie von Mikroorganismen, Retzbach-Zellingen, **2006**.

Poster Presentation

Chemie und Biologie der Archazolide
Hochschule trifft Industrie 27.-29. September **2007** in Berlin Postdam.

Kurzfassung

Jun Li

Total Synthesis of Archazolid A and Studies Towards the Total Synthesis of Etnangien

Stichwörter: Archazolid A, Totalsynthese, Entschützung von Silylethern, Aminierung

Archazolid A ist ein potenter V-ATPase Inhibitor aus dem Myxobacterium *Archangium gephyra*. Im Rahmen dieser Dissertation wurde eine erste Totalsynthese von Archazolid A realisiert. Die erfolgreiche Synthesestrategie zu diesem komplexen Polyketid beruht auf der Verknüpfung von drei Bausteinen durch eine Aldolkondensation, eine Heck-Reaktion und eine HWE-Makrocyclisierung. Sie verlief in insgesamt 20 Stufen und 4% Gesamtausbeute (längste lineare Sequenz) und etablierte eindeutig die relative und absolute Konfiguration dieses Naturstoffes. Eines der Hauptfragmente, die C14-C19 Untereinheit, wurde in einer direkten Route in 10 Stufen und 54% Gesamtausbeute erhalten. Schlüsselmerkmale der Synthese beinhalten eine optimierte Prozedur, um ein E-Vinyliodid herzustellen und eine hochenantio- und diastereoselektive *Abiko-Masamune anti* Aldol Reaktion zum Aufbau der C16 und C17 Stereozentren. In diesem Zusammenhang wurde eine neuartige Methode zum direkten Austausch des *Abiko-Masamune* Auxiliars durch verschiedene Nucleophile unter Verwendung von *i*PrMgCl zur Carbonyl-Aktivierung entwickelt.

Etnangien ist ein makrocyclisches Polyketid aus dem Myxobakterium *Sorangium cellulosum*. Es zeigt antibiotische Aktivität gegen verschiedene Gram-positive Bakterien durch RNA-Polymerase Inhibierung. Im Rahmen dieser Arbeit wurde der makrocyclische Kern von Etnangien erfolgreich aus drei Schlüsselbausteinen synthetisiert, die durch eine Ipc-Bor-vermittelte Aldol-Reaktion, eine *Yamaguchi* Veresterung und eine hochgradig E-selektive Heck Makrocyclisierung verknüpft wurden. Die Synthese verläuft in 18 Stufen und 27% Gesamtausbeute (längste lineare Sequenz). Die C15-C23 Untereinheit wurde in 11 Stufen mit 37% Ausbeute erhalten. Bemerkenswerte Kennzeichen beinhalten eine *Paterson anti*-Aldol Reaktion zum Aufbau der Stereozentren an C20/C21, ein optimiertes Protokoll für eine *Wittig* Reaktion, eine innovative TBS Schützungsverfahren, die Protonenschwamm[®] als Base verwendet und eine hocheffiziente oxidative Diol-Spaltung durch Pb(OAc)₄.

Darüber hinaus wurde eine neue selektive Methode zur Entschützung von Silylethern entwickelt, die die Verwendung von NaIO₄ beinhaltet. Die milden nichtsauren und basischen Bedingungen gestatten Anwendungen auch bei komplexen und säure- oder basenempfindlichen Substraten.

Schließlich wurde eine effiziente Prozedur zur Synthese strukturell verschiedenartiger diverser tertiärer Amine unter Verwendung eines Thioharnstoff-katalysierten direkten reduktiven Aminierungsprotokolls entwickelt. Diese tertiären Amine erwiesen sich als potente wachstumshemmende Verbindungen.

Abstract

Jun Li

Total Synthesis of Archazolid A and Studies Towards the Total Synthesis of Etnangien

Keywords: Archazolid A, total synthesis, silyl ether deprotection, amination

Archazolid A is a potent V-ATPase inhibitor from the myxobacterium *Archangium gephyra*. During this thesis a first total synthesis of archazolid A was accomplished. The successful synthetic strategy for this complex polyketide involved coupling of three main building blocks, which was achieved by an aldol condensation, a *Heck*-reaction and a *HWE* macrocyclisation. In total, it proceeds in 20 steps and 4% overall yield (longest linear sequence) and unequivocally establishes the relative and absolute configuration of this natural product. One of the main fragments, the C14-C19 subunit was synthesized in 10 steps with 54% overall yield. Key features of the synthesis included an optimized procedure to prepare an *E*-vinyl iodide and a highly enantio- and diastereoselective *Abiko-Masamune anti* aldol reaction for the construction of the C16 and C17 stereocentres. Within this context, a novel method for a direct displacement of the *Abiko-Masamune* auxiliary by various nucleophiles was established by using *i*PrMgCl for carbonyl activation.

Etnangien is a macrocyclic polyketide from the myxobacterium *Sorangium cellulosum*. It shows antibiotic activity against various gram-positive bacteria by inhibition of RNA polymerase. During this thesis the macrocyclic core of etnangien was successfully synthesized from three key building blocks using a *Ipc*-boron-mediated aldol reaction, a *Yamaguchi* esterification and highly *E*-selective *Heck* macrocyclization. It proceeds in 18 steps and 27% overall yield (longest linear sequence). The C15-C23 subunit was synthesized in 11 steps and 37% yield. Notable features include a *Paterson anti*-aldol reaction to install the stereocentres at C20/C21, an optimized *Wittig* reaction procedure, an innovative method of TBS protection by use of proton sponge[®] as base and a highly efficient oxidative diol-cleavage with Pb(OAc)₄.

Furthermore, a new selective method for deprotection of silyl ethers was developed, which involves use of NaIO₄. The mild nonacidic and -basic conditions enable applications to complex and acid- or base-sensitive substrates.

Finally, an efficient procedure was developed to synthesize structurally diverse tertiary amines by employing a thiourea-catalyzed direct reductive amination protocol. These tertiary amines were shown to be potent antiproliferative agents.

Danksagung

Die vorliegende Arbeit wurde am Helmholtz-Zentrum für Infektionsforschung in Braunschweig in der Abteilung Medizinische Chemie unter Anleitung von **Prof. Dr. Dirk Menche** von Oktober 2005 bis Oktober 2008 angefertigt.

Mein besonderer Dank gilt meinem Betreuer, **Prof. Dr. Dirk Menche**, für diese interessante Themenstellung, die zahlreichen Anregungen, die stetige Bereitschaft zur Diskussion der Ergebnisse und Probleme. Die intensive Betreuung und materielle Unterstützung halfen sehr, die vorliegende Arbeit zu vollenden.

Mein Dank gilt **Prof. Dr. Markus Kalesse** für die Aufnahme in seine Abteilung am Helmholtz-Zentrum für Infektionsforschung in Braunschweig und für die Möglichkeit, am Institut für Organische Chemie der Gottfried Wilhelm Leibniz Universität promovieren zu können.

Mein Dank gilt außerdem allen weiteren Mitgliedern des Arbeitskreises Prof. Menche, die mir bei all meinen Problemen geholfen haben und immer ein offenes Ohr dafür hatten. Für die hervorragende und herzliche Zusammenarbeit danke ich vor allem Dr. Jorma Hassfeld, Dr. Nicole Horstmann, Wiebke Ahlbrecht, Fatih Arikan, Pengfei Li, Sven Rudolph, Tatjana Arnold, Antje Ritter, Wiebke Zander und Inga Degenhard.

Für die ständig vorhandene Diskussionsbereitschaft möchte ich bei Heinrich Steinmetz, Dr. Rolf Jansen und Dr. Jutta Niggemann bedanken. Für das Korrekturlesen danke ich speziell Dr. Jutta Niggemann.

Den Mitarbeitern am HZI in Braunschweig, danke ich für die gute Zusammenarbeit, vor allem Christel Kakoschke und Beate Jaschok-Kentner für die Aufnahme der NMR-Spektren, Undine Felgenträger für die MS Messungen, Antje Ritter und Susanne Engelkes für HPLC-MS Messungen. Der MS Abteilung an der Universität Hannover danke ich für die HRMS Messungen.

Table of Contents

1	Introduction and Research Objectives.....	1
1.1	Myxobacteria	2
1.2	Archazolid A and B	3
1.3	Etnangien	6
1.4	Research Objectives	8
2	Polyketide Synthesis.....	9
2.1	Biosynthesis	10
2.2	Synthetic Approaches	12
2.2.1	Auxiliary-Controlled Diastereoselective Aldol Reactions	12
2.2.1.1	<i>Evans syn</i> Aldol Reaction	14
2.2.1.2	<i>Evans anti</i> Aldol Reaction	16
2.2.1.3	<i>Abiko–Masamune</i> Aldol Reaction	17
2.2.1.4	<i>Paterson</i> Aldol Reaction	18
2.2.2	Asymmetric Crotylation Reactions	20
2.2.2.1	<i>B</i> -Crotylation Reactions	22
2.2.2.2	<i>Duthaler-Hafner Ti</i> -Crotylation Reactions	24
2.2.2.3	<i>Leighton Si</i> -Crotylation Reactions	25
2.2.3	Addition of Chiral Allenylzinc and Indium Reagents to Aldehydes	25
2.2.4	Epoxide Opening	27
2.2.5	2,3- <i>Wittig</i> Sigmatropic Rearrangement	28
2.2.6	Diastereoselective anti-S _N 2' allylic Displacement Reactions	30
3	Total Synthesis of Archazolids.....	31
3.1	Retrosynthetic Analysis	31
3.2	Synthesis of the C3-C13 Subunit – Dr. <i>Jorma Hassfeld</i>	33
3.3	Synthesis of the C20-C1" Subunit – <i>Sven Rudolph</i>	35
3.4	Synthesis of the C14-C19 Subunit	37
3.4.1	Plan 1: <i>Evans anti</i> Aldol Reaction	37
3.4.2	Plan 2: <i>Noyori's</i> Asymmetric Transfer Hydrogenation	39
3.4.3	Plan 3: <i>Abiko-Masamune anti</i> Aldol Reaction	40
3.4.3.1	Synthesis of the Vinyl iodide	41
3.4.3.2	<i>Abiko–Masamune anti</i> Aldol Reaction	43
3.4.3.3	<i>O</i> -Methylation of the Aldol Adduct	44
3.4.3.4	The Phosphonate Fragment	45
3.4.3.5	The Methyl Ketone Fragment	48
3.4.3.6	Conclusion	49
3.5	Connection of the C3-C13 and the C14-C19 Subunits	50

3.5.1	<i>HWE</i> -Reactions between Phosphonate 118 and Aldehyde 143	50
3.5.2	Aldol Condensation between Methyl Ketone and Aldehyde	51
3.6	Connection of the C3-C19 and the C20-C1" Subunits	52
3.7	Completion of the First Total Synthesis	53
3.8	<i>Heck</i> -Macrocyclisation: Towards Archazolid B	56
3.9	Conclusion	57
4	Studies Towards the Total Synthesis of Etnangien.....	58
4.1	Retrosynthetic Analysis	58
4.2	Synthesis of the C34-C42 Subunit – <i>Fatih Arikan</i>	60
4.3	Synthesis of the C24-C31 Subunit – <i>Pengfei Li</i>	62
4.4	Synthesis of the C15-C23 Subunit	63
4.4.1	Synthesis of the Aldehyde Fragment – <i>Wittig</i> Reaction	63
4.4.2	Construction of the Stereocentre C20/C21 – <i>anti</i> Aldol Reactions	66
4.4.2.1	The <i>Abiko-Masamune anti</i> Aldol Strategy	66
4.4.2.2	The <i>Paterson anti</i> Aldol Strategy	68
4.4.3	Conclusion	72
4.5	Connection of the C15-C23 and the C24-C31 Subunits	73
4.5.1	The Model <i>Ipc</i> -Boron Aldol Reaction with Methyl Ketone 219	73
4.5.2	The <i>Ipc</i> -Boron Aldol Reaction	75
4.5.3	Reduction of the Ketone 225 and Selective Protection of the Diol 227	77
4.6	Connection of the C15-C31 and the C32-C42 Subunits	79
4.7	Completion of the Macrolide Moiety: <i>Heck</i> -Macrocyclization	80
4.8	Synthesis of Analogues of the Etnangien Macrolide Structure	83
4.8.1	<i>Heck</i> Macrocyclization	83
4.8.2	<i>Sonogashira</i> Macrocyclization	84
4.9	Conclusion	85
5	Selective Deprotection of Silyl Ethers with NaIO₄.....	86
5.1	Introduction	86
5.2	Result and Discussion	87
5.3	Conclusion	90
5.4	Preparation of Silyl Ethers	91
6	Direct Reductive Amination.....	93
6.1	Introduction	93
6.2	One-Pot Synthesis of Hindered Tertiary Amines	96
6.2.1	Dialkylation of Amines with Ketone and Aldehyde	96

6.2.2	Dialkylation of <i>para</i> -Anisidine with two Aldehydes	97
6.2.3	Dialkylation of Different Amines with Isobutyraldehyde and Benzaldehyde	99
6.3	Biological activity	101
6.4	Conclusion	103
7	Summary	104
7.1	Total Synthesis of Archazolid A	104
7.2	Studies Towards the Total Synthesis of Etnangien	106
7.3	Selective Deprotection of Silyl Ethers with NaIO ₄	107
7.4	Direct Reductive Amination	108
8	Experimental Section	109
8.1	General Methods	109
8.2	Preparation of Reagents	110
8.3	Total Synthesis of Archazolids	116
8.3.1	Synthesis of alcohol 64a for the C3-C13 subunit	116
8.3.2	Synthesis of the C14-C19 Subunit	118
8.3.2.1	Plan 1: <i>Evans anti</i> Aldol Reaction	118
8.3.2.2	Plan 2: <i>Noyori's</i> asymmetric transfer hydrogenation	121
8.3.2.3	Plan 3: <i>Abiko-Masamune anti</i> Aldol Reaction	125
8.3.3	Connection of the C3-C13 and the C14-C19 Subunits	136
8.3.4	Connection of the C3-C19 and the C20-C1" Subunits	139
8.3.5	Heck-Macrocyclisation: Towards Archazolid B	142
8.4	Studies Towards the Total Synthesis of Etnangien	144
8.4.1	Synthesis of the C15-C23 Subunit	144
8.4.1.1	Synthesis of the Aldehyde Fragment – <i>Wittig</i> Reaction	144
8.4.1.2	Construction of the Stereocentres at C20 and C21	148
8.4.2	Connection of the C15-C23 and the C24-C31 Subunits	160
8.4.3	Connection of the C15-C31 and the C32-C42 Subunits	170
8.4.4	Completion of the Macrolide Moiety	172
8.4.5	Synthesis of Analogues of Etnangien Macrolide Structure	175
8.5	Selective Deprotection of Silyl ethers with NaIO ₄	181
8.5.1	General procedure for deprotection of silyl ethers	181
8.5.2	Preparation of Silyl Ethers	186
8.6	Direct Reductive Amination	195
	References and Notes	199
	Curriculum Vitae	
	NMR-Spectra	

List of Abbreviations, Acronyms, and Symbols

$[\alpha]_D^T$	specific rotation at temperature T at the sodium D line
Å	angstrom
Ac	acetyl
aq.	aqueous
Ar.	aryl
Bn	benzyl
BOP	(benzotriazol-1-yloxy)tris-(dimethylamino)phosphonium hexafluorophosphat
Bu	butyl
<i>t</i> Bu.	<i>tert</i> -Butyl
<i>n</i> BuLi	<i>n</i> -Butyllithium
Bz	benzoyl
<i>c</i>	concentration
°C	degree centigrade
cat.	catalytic
CDCl ₃	Deuterated Chloroform
CoA	coenzyme A
COSY	Correlation Spectroscopy
Cp	cyclopentadienyl
18-c-6	18-crown-6
CSA	10-camphorsulfonic acid
Cy/ <i>c</i> Hex	cyclohexyl
CH ₂ Cl ₂	dichlormethane
CH ₃ CN	acetonitrile
δ	NMR chemical shift in ppm downfield from a standard
d	day, doublet
DABCO	1,4-diazabicyclo[2.2.2]octane
DBU	1,8-diazabicyclo[5.4.0]undec-7-ene
DDQ	2,3-dichloro-5,6-dicyano-1,4-benzoquinone
DIBAL-H	diisobutylaluminum hydride
DIPCI	<i>B</i> -chloro-diisopinocampheyl borane
DMAP	4- <i>N,N</i> -dimethylamino pyridine

DMF	<i>N,N</i> -dimethyl formamide
DMP	<i>Dess–Martin</i> periodinane
DMPM	3,4-dimethoxybenzyl
DMSO	dimethyl sulfoxide
d.r.	diastereomeric ratio
<i>ee</i>	enantiomeric excess
EI	electron impact ionization
eq.	equivalent
Et	ethyl
Et ₂ O	diethyl ether
EtOAc	ethyl acetate
exc.	excess
GC	Gas chromatography
g	gram
h	hour
HMDS	1,1,1,3,3,3-hexamethyldisilazane
HPLC	high-pressure liquid chromatography
HRMS	High resolution mass spectroscopy
HWE	Horner-Wadsworth-Emmons
Hz	hertz
IC ₅₀	concentration that is infective in 50% of test subjects
Ipc	isopinocampheyl
<i>i</i> Pr	<i>iso</i> -Propyl
<i>J</i>	coupling constant
KHMDS	potassium 1,1,1,3,3,3-hexamethyldisilazide
LAH	lithium aluminum hydride
LDA	lithium diisopropyl amide
LHMDS	lithium 1,1,1,3,3,3-hexamethyldisilazide
m	multiplet
M	molarity (moles·l ⁻¹)
Me	methyl
mg	milligram
MHz	megahertz
min	minute

mL	milliliter
μL	microliter
mmol	millimole
μmol	micromole
mol%	mole per cent
mp	melting point
M.S.	molecular sieves
MS	mass spectrometry
MTPA	2-methoxy-2-phenyl-2-(trifluoromethyl) acetic acid
NMM	<i>N</i> -methyl morpholine
NMO	<i>N</i> -methyl morpholine <i>N</i> -oxide
NMR	Nuclear Magnetic Resonance
NOE	Nuclear Overhauser Effect
NOESY	Nuclear Overhauser Enhancement Spectroscopy
Nu	nucleophile
Oxone	potassium peroxymonosulfate $2\text{KHSO}_5 \cdot \text{KHSO}_4 \cdot \text{K}_2\text{SO}_4$
<i>p</i>	<i>para</i>
Ph	phenyl
PKS	polyketide synthetase
PMB	4-methoxybenzyl
ppm	parts per million
PPTS	pyridinium 4-toluenesulfonate
Pr	propyl
proton sponge	<i>N,N,N',N'</i> -tetramethyl-1,8-naphthalene-diamine
py.	pyridine
q	quartet
quant.	quantitative
rec.	recovered
R_f	retention factor
ROESY	Rotating Frame Overhauser Enhancement Spectroscopy
RT	room temperature
s	second, singlet
sat.	saturated
SM	starting material

t	triplet
T	temperature
TBAB	tetra- <i>n</i> -butylammonium bromide
TBAF	tetra- <i>n</i> -butylammonium fluoride
TBDPS	<i>tert</i> -butyldiphenylsilyl
TBS	<i>tert</i> -butyldimethylsilyl
TCBC	2,4,6-trichlorobenzoyl chloride
TEMPO	2,2,6,6-tetramethylpiperidine 1-oxyl radical
TES	triethylsilyl
Tf	trifluoromethanesulfonyl
TFA	trifluoroacetic acid
THF	tetrahydrofuran
TLC	thin layer chromatography
TMS	trimethylsilyl
Ts	4-methylphenyl sulfonyl
TPAP	tetra- <i>n</i> -propylammonium perruthenate
vs	versus

1 Introduction and Research Objectives

Nature presents us countless numbers of natural products with complex, fascinating chemical structures and useful, important biological properties. For thousands of years, natural products have been closely linked through the use of traditional medicines, as for example traditional chinese medicine. Today, more than 60% of new chemical entities introduced as drug are, or were derived by natural products,¹ that demonstrate that natural products play a highly significant role in the drug discovery and development process.

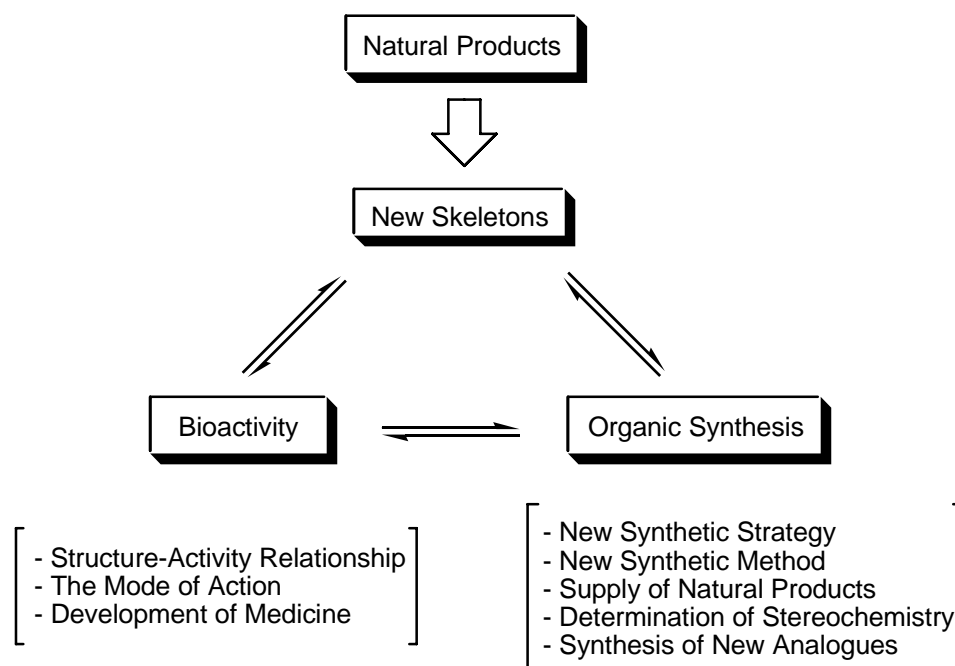


Figure 1 Relationship of the natural products, organic synthesis and bioactivity.

The synthesis of natural products commands an important role in organic and biological chemistry (Figure 1).² The key challenge in total synthesis of natural products is to efficiently synthesize target compounds with unique, novel molecular skeletons by using short process pathways. The construction of novel molecular skeletons necessitates the development of new synthetic strategies and reactions, which lead to further progress in synthetic organic chemistry. Using synthetic approaches, it will also be possible to determine structures and the relative and absolute configuration of natural products. Furthermore, use of newly developed methods for the rapid assembly of molecular skeleton will allow the creation of a wide range of analogues, thereby leading to the production of compounds with properties that may

surpass those found in nature and heralding the promise of bioactivity. This also enables the study of structure-activity relationship with analogues of natural products.

Among those producers of natural products are bacteria, lichens, fungi, plants or animals. One of them is a group of bacteria, named myxobacteria, which have increasingly gained attention over the last two decades because they produce a large variety of natural products with medically potentially useful biological activities.³

1.1 Myxobacteria

Myxobacteria are gram-negative bacteria which predominantly live in the soil and are most noted for their ability to form fruiting bodies upon starvation (Figure 2). They are a particularly rich source of structurally novel and biosynthetically intriguing secondary metabolites which exhibit a wide range of biological activities based on diverse molecular mechanisms of action.⁴ These mechanisms of action are diverse and include electron transport inhibition, destruction of the cytoskeleton, inhibition of nucleic acid polymerases and inhibition of fungal acetyl-CoA carboxylase. It is particularly remarkable that myxobacterial metabolites exhibit modes of action that are rarely observed with other microbial compounds, which makes them a promising source for novel drug leads.⁵

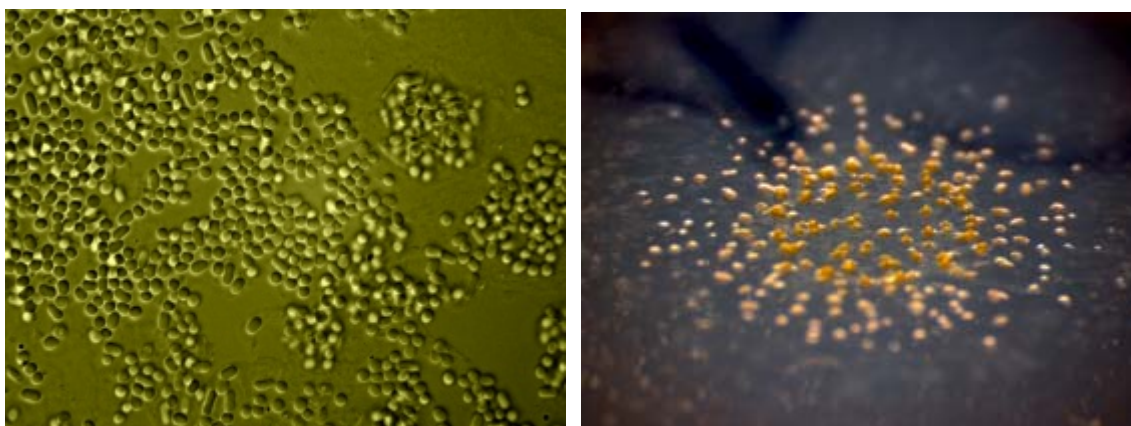


Figure 2 Microscopic picture of spores and fruiting bodies from *Myxococcus xanthus*.

Prominent examples of these secondary metabolites from myxobacteria are epothilone A (**1**) and B (**2**, Figure 3)⁶ whose analogue, Ixabepilone (**3**, Figure 3) (also known as azaepothilone B) has recently been approved by the US FDA as a chemotherapy agent for the treatment of aggressive metastatic or locally advanced breast cancer and marketed under the trade name

Ixempra (Bristol-Meyers Squibb company). It binds to β -tubulin subunits on microtubules, blocking cells in the mitotic phase of the cell-division cycle, leading to cell death.⁷

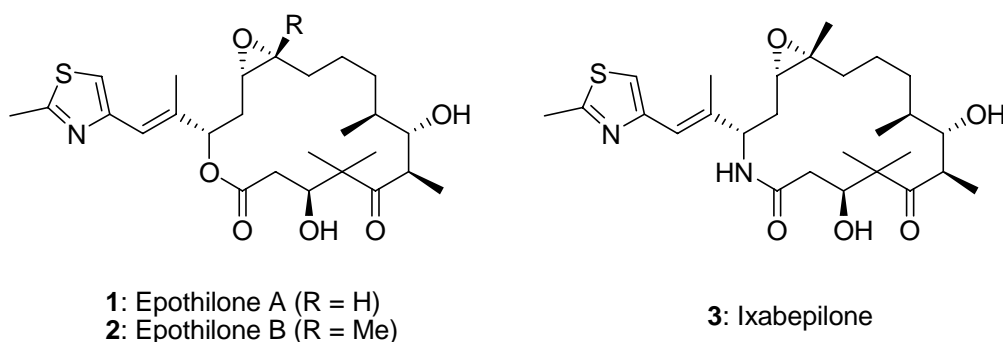


Figure 3 Structures of epothilone A, B (1, 2) and Ixabepilone (3).

Structurally, myxobacteria produce an architecturally and functionally diverse class of natural products. The compounds thus far elucidated are mostly macrocyclic lactone and lactam rings or linear and cyclic peptides. Moreover, substances that would be classified as aromatics, heterocycles, polyenes, or alkaloids have also been found. Structures with triple bonds, a boron-complexing compound and, rather often, chlorinated substances do also occur. Under biosynthetic aspects, myxobacterial metabolites mostly belong to polyketides.⁸

1.2 Archazolid A and B

Archazolid A and B (4, 5, Figure 5)⁹ have been isolated from the culture broths of strains of the myxobacterium *Archangium gephyra* (Figure 4) and *Cystobacter sp.* After purification of 300-liter fermentation of *Archangium gephyra* gave 249 mg archazolid A (4) and 54 mg archazolid B (5) have been obtained.¹⁰

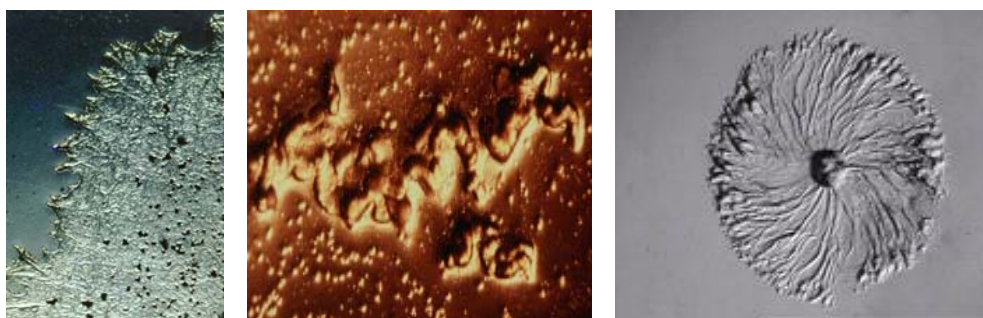


Figure 4 The myxobacterium *Archangium gephyra*.

Archazolid A (**4**) and B (**5**) are cytotoxic polyketides. They are highly effective against a wide range of mammalian cell lines and were shown to inhibit V-ATPase *in vitro*¹¹ and *in vivo*¹⁰ with IC₅₀ values in low nanomolar range. Together with other polyketides such as chondropsin A (**6**),¹² FD-891 (**7**),¹³ palmerolide A (**8**)¹⁴ and lejimalide A (**9**)¹⁵, archazolid A (**4**) and B (**5**) belong to an elite class of potent V-ATPase inhibitors (Figure 5). Recently, Huss *et al.* demonstrated that archazolid A (**4**) binds selectively to the transmembrane bound V_o subunit c¹¹. As shown in Figure 6 (left side), this subunit forms an oligomer, building up a ring structure of six or more copies which transports protons across the membrane.

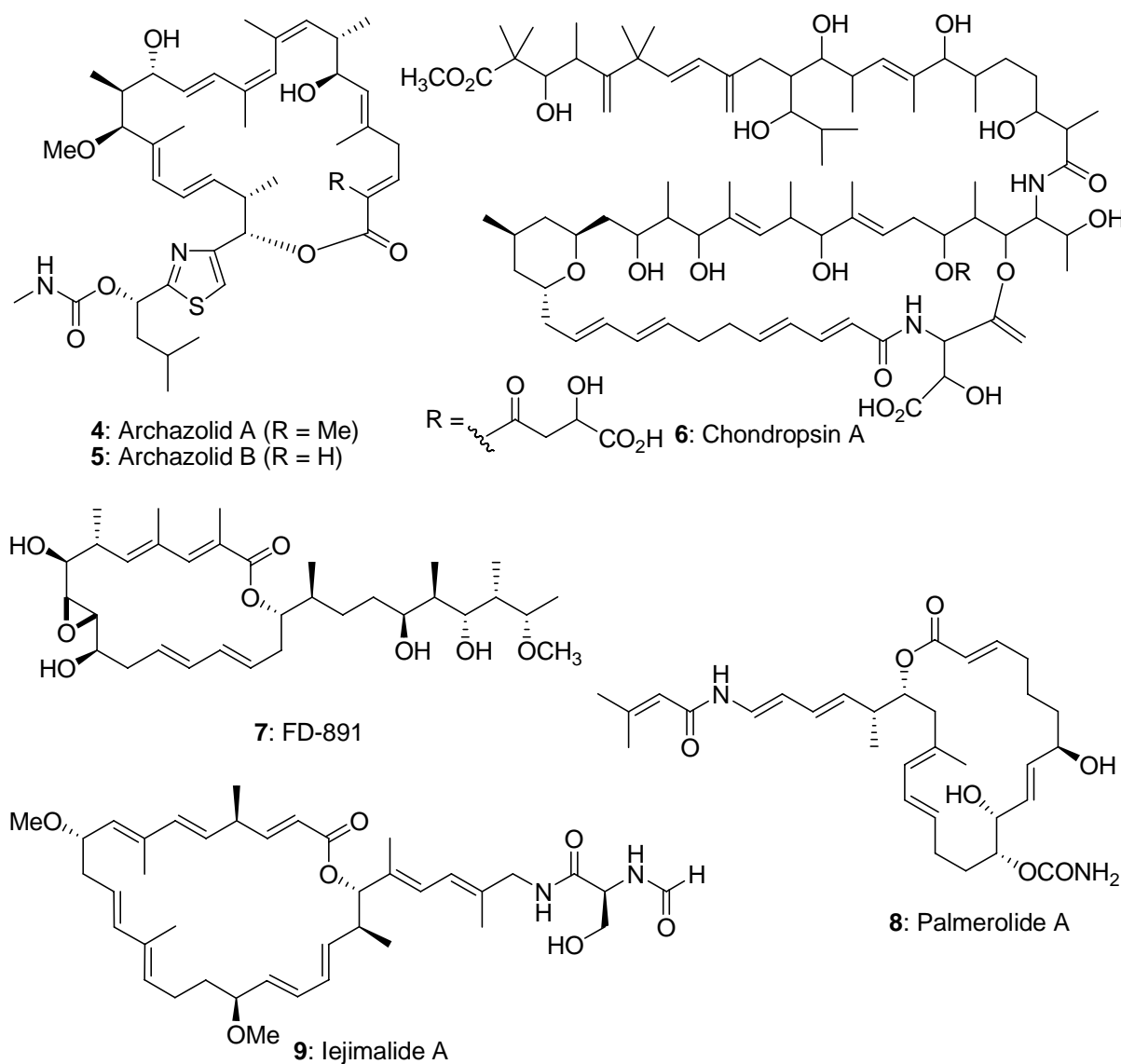


Figure 5 Potent V-ATPase inhibitors.

To visualize the impact of the inhibition, PtK2 (potooroo kidney) cells have been incubated with archazolid A (**4**) and stained for intact acidic lysosomes at our Institute by *Florenz Sasse*. Lysosomes (in red), which are labeled by pH-indicators, are shown in the fluorescent photographs in Figure 13 (right side). When this system is treated with archazolid A (**4**), the red staining disappears. This indicates that the proton pumps are stopped and suggests that archazolid A (**4**) is an inhibitor of the V-ATPases (Figure 6, right side).¹¹

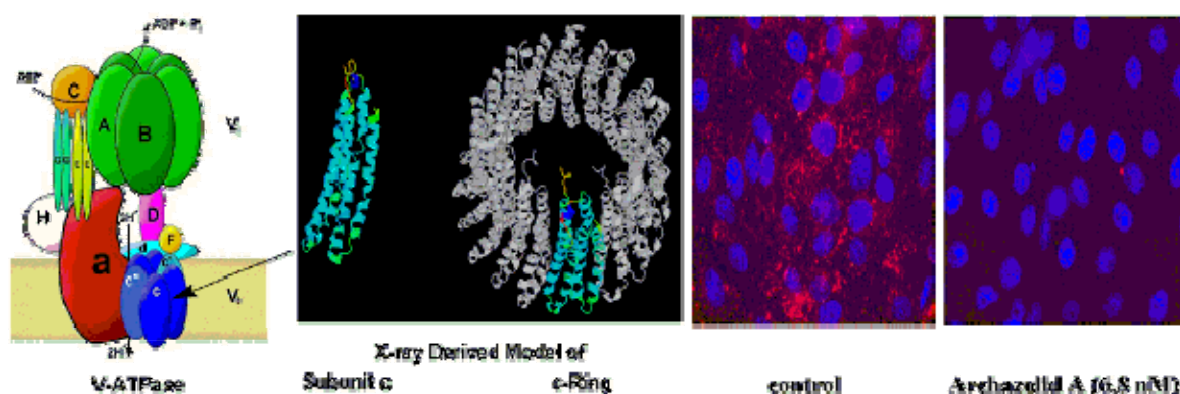


Figure 6 X-ray derived model of subunit c of the V_o complex of V-ATPase, the binding site of the archazolids (left side) and inhibition of lysosomal acidification by archazolid A (right side).

A malfunction of these V-ATPases is correlated with various diseases, like osteoporosis and cancer.¹⁶ This renders the development and understanding of novel potent inhibitors such as these polyketide macrolides, important research goals.

The structure of the archazolids (**4**, **5**, Figure 5) features a 24-membered macrolactone ring with seven alkenes (*2E*, *5E*, *9Z*, *11Z*, *13E*, *18E*, *20E*), a thiazole side chain and a characteristic sequence of eight methyl and hydroxyl-bearing stereocentres. The full stereostructure of the archazolids was determined by application of *J*-based configuration analysis in combination with extensive NOESY and ROESY experiments, molecular modeling and synthetic derivatization.¹⁷

1.3 Etnangien

The polyketide natural product etnangien (**14**, Figure 9)¹⁸ was isolated from culture broths of various strains of the myxobacterium *Sorangium cellulosum* (Figure 7) including strains So ce750 and So ce1045. The cultivation was performed in the presence of 1% (w/v) of the neutral resin Amberlite XAD 16, which removed the metabolites from the broth during cultivation, resulting in an average production of 5 mg/L.¹⁹



Figure 7 The myxobacterium *Sorangium cellulosum*.

Etnangien (**14**) shows pronounced antibiotic activity against various gram-positive bacteria (IC_{50} : ~100 nM) by inhibition of RNA polymerase. Moreover, it shows no cross-resistance to rifampicin (**10**, Figure 9) a clinically valued RNA polymerase inhibiting antibiotic.¹⁹ RNA polymerase (RNAP or RNAPol) is the enzyme that generates RNA from DNA. RNA polymerase enzymes are essential to life and are found in all organisms and many viruses (Figure 8).²⁰

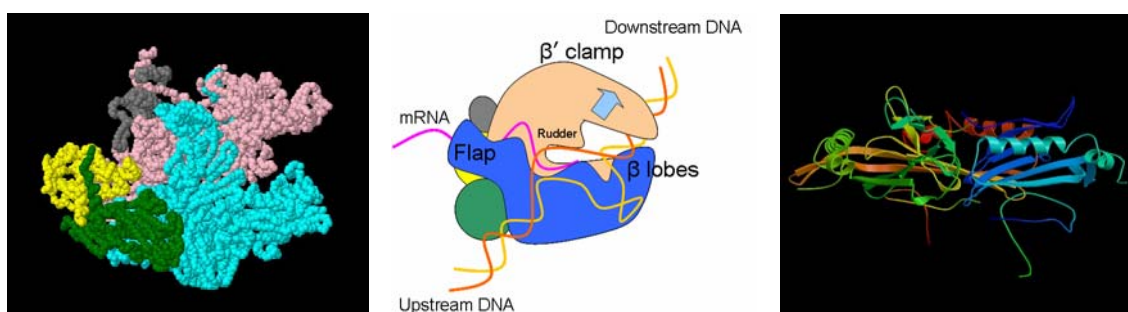


Figure 8 Bacterial DNA-dependent RNA polymerase.

Bacterial DNA-dependent RNA polymerase is an attractive drug target because RNA chain elongation is essential for bacterial growth.²¹ There are several known, or suspected, inhibitors of bacterial DNA-dependent RNA polymerase of myxobacterial origin (Figure 9, **11-14**) that are promising candidates for further development. These agents include the corallopyronins²², ripostatins,²³ and sorangicins²⁴ (**11, 12, 13**, Figure 9).

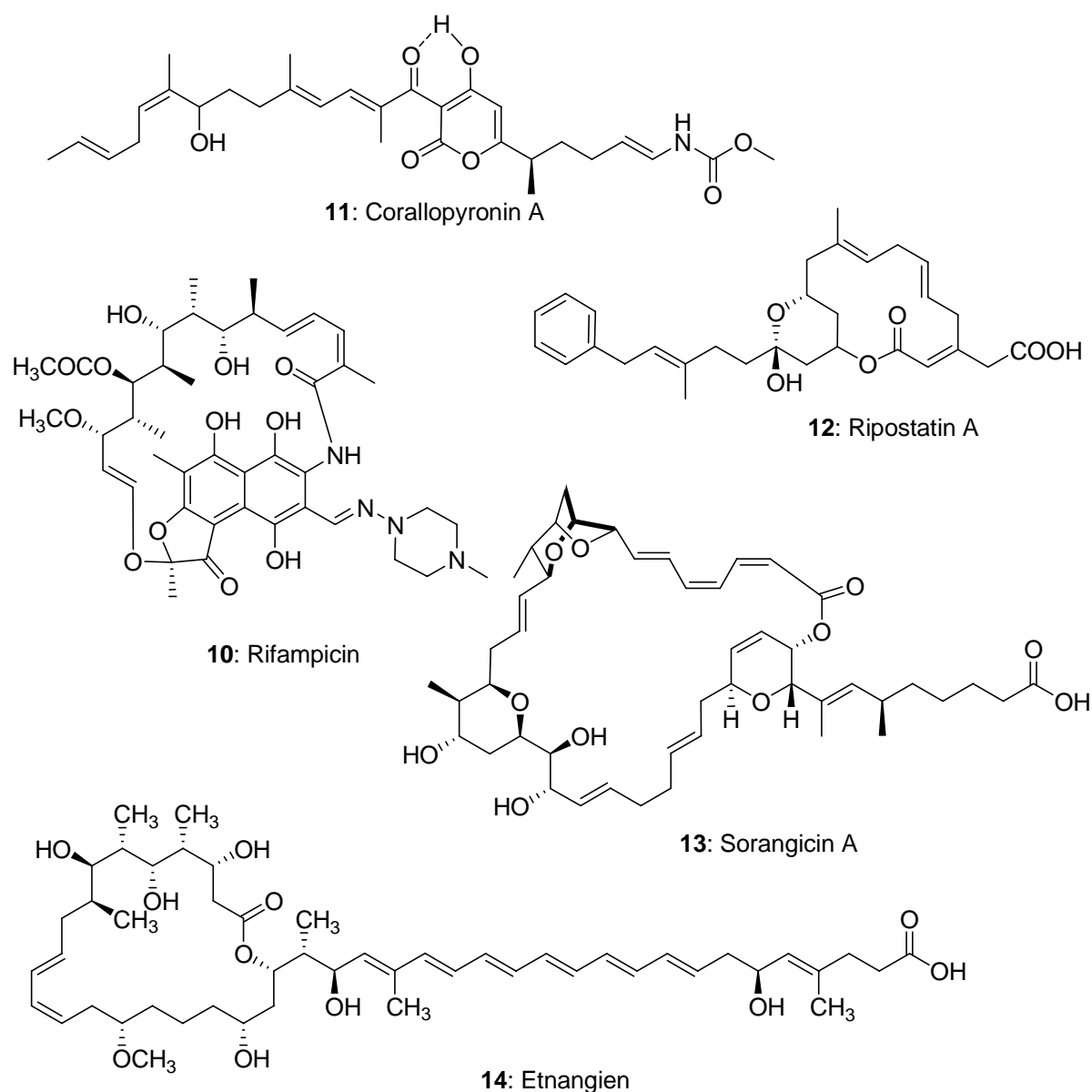


Figure 9 Inhibitors of bacterial DNA-dependent RNA polymerase.

Bacterial resistance has been increasingly developing to the rifamycins (**10**), the only class of RNA polymerase inhibitor that is in use clinically. Therefore, the development of novel types of RNA polymerase inhibitors is an important research goal.²⁵

The constitution of etnangien (**14**) consists of a 22-membered macrolactone with two alkenes (30*Z*, 32*E*) and a polyunsaturated side chain with seven *trans* configured alkenes. In total, it comprises an array of 12 stereogenic centres. The full stereostructure of etnangien (**14**) was determined by a combination of high field NMR method, including Murata's method of *J*-based configurational analysis, molecular modelling and genetic methods, relying on the development of a biosynthetic model based on a highly complex megasynthetase.²⁶

1.4 Research Objectives

In summary, archazolid A, B (**4**, **5**) and etnangien (**14**) present highly promising and synthetically challenging macrolide antibiotics. For further development of these polyketides, synthetic approaches are of critical importance.

Specific **research objectives** of this project have been.

- (i) development of a synthetic route to the northwestern fragment of archazolids (**4**, **5**);
- (ii) fragment union and completion of the total synthesis of archazolids (**4**, **5**);
- (iii) development of a synthetic strategy to the central C15-C23 segment of etnangien (**14**);
- (iv) preparation of sufficient quantities of the macrocyclic core of etnangien (**14**); and
- (v) development of novel methods along the lines of these research objectives (i)-(iv).

2 Polyketide Synthesis

Polyketides are a large family of structurally diverse natural products that possess a broad range of pharmacological properties and, together with their semi-synthetic analogues, play a vital role in human and veterinary medicine.²⁷ Although diverse in structure and properties, polyketides can be grouped into two overall classes: the aromatic and the complex polyketides including marolides, polyethers, polyens and macrocyclic lactams. The complex polyketides are structurally more diverse than the aromatic ones. One example for an aromatic polyketide is the tetracycline (**15**, Figure 10), an antibiotic. On the contrary, the archazolids (**4**, **5**, Figure 10) and etnangien (**14**, Figure 10), secondary metabolites from myxobacteria, may be classified as complex polyketides.

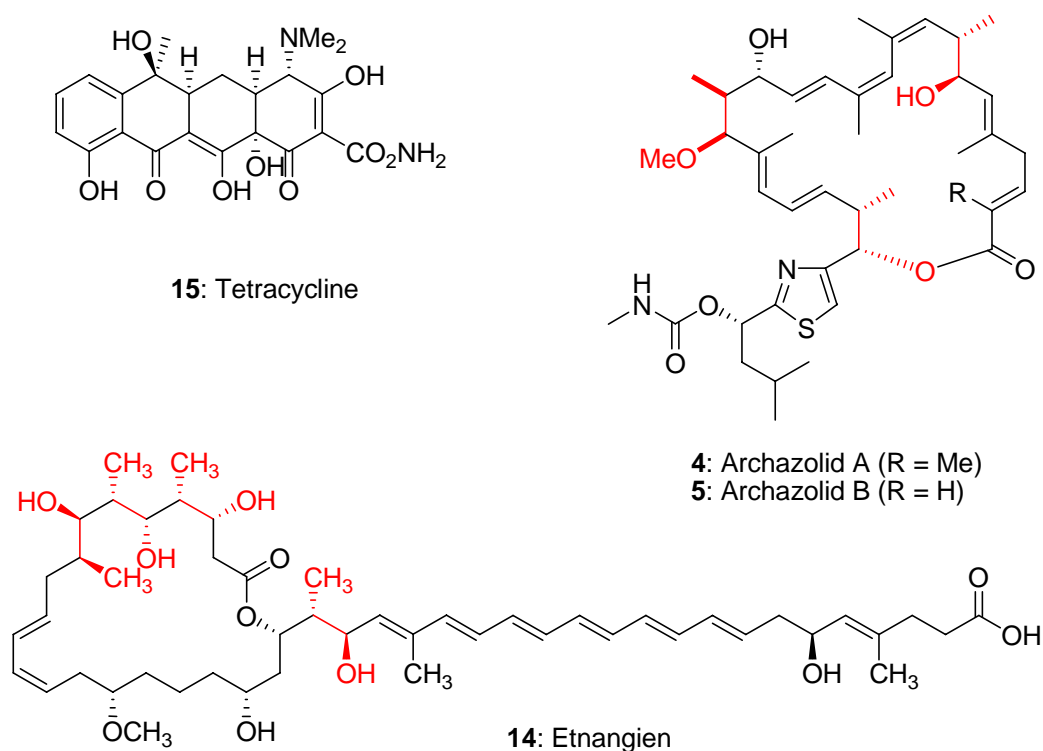


Figure 10 Examples of polyketides.

2.1 Biosynthesis

Biosynthetically, polyketides are constructed by repetitive *Claisen* condensations of extender units derived from malonyl coenzyme A (CoA) with an activated carboxylic acid starter unit in a manner that closely parallels fatty acid biosynthesis. Polyketides derive their enormous diversity in structures through a number of programmed events that are dictated by the polyketide synthase (PKSs) and involve the selection of starter and extender units, carbon chain length, folding, degree of reduction, and termination. Post PKS tailoring events such as glycosylation, acylation, alkylation and oxidation further add to polyketides structural diversity. PKSs utilize a wide assortment of starter units, such as short-chain (branched) fatty acids, various alicyclic and aromatic acids, and amino acids in the assembly of their products. In many cases, the nature of the primer unit provides important structural and biological features to the molecule.²⁸

As shown in Figure 11,²⁹ PKSs catalyze the modular chain extension by repetitious *Claisen* condensations between acetyl-SACP and malonyl-SACP to afford β -keto esters. Each condensation is followed by oxidation-state adjustment before subsequent reiteration of the cycle: keto reduction, dehydration, and enoyl reduction. In contrast to the biosynthesis of fatty acids, the whole reductive cycle need not be passed, allowing for a highly selective and controlled assembly of polyketide intermediates with a sheer endless number of possible combinations along the growing chain (pathway A–D). Virtually every imaginable array of relative configuration may be produced by the action of polyketide synthetases. The elimination step can be entirely omitted, reducing the cycle to condensation followed by keto-reduction, giving rise to a regular array of 1,3-polyols (pathway B). The chain-extender unit is malonyl-SACP for the synthesis of fatty acids and aromatic polyketides, but varies for reduced polyketides: incorporation of propionate or butyrate residues (from methylmalonyl-CoA or ethylmalonyl-CoA chain extenders) produces methyl or ethyl side chains in the polyketide product.

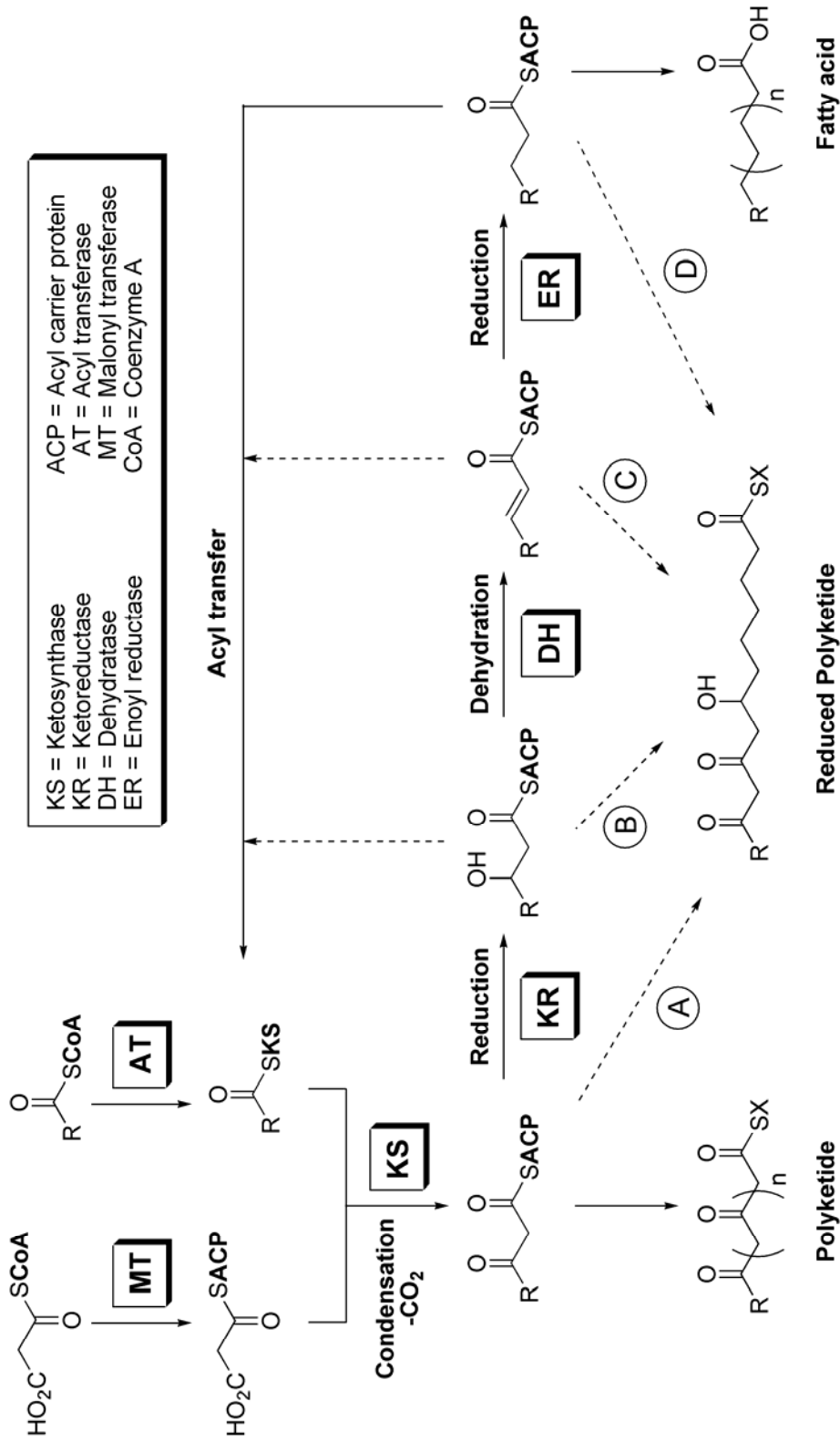


Figure 11 The basic pathway of fatty acid and polyketide biosynthesis.

2.2 Synthetic Approaches

The inherent stereochemical complexity present in polyketides like archazolides (**4**, **5**, Figure 10) and etnangien (**14**, Figure 10) has captured the imagination of organic chemists. Their stereocontrolled, asymmetric total synthesis has stimulated the development of a host of new reactions and methods for C–C bond construction in the context of acyclic stereocontrol.

As can be seen from the red labels in Figure 10, assemblies of alternating methyl- and hydroxyl-bearing stereogenic centres are characteristic features in polyketide natural products. Those units mostly are installed with propionate as starter and methylmalonyl-CoA as chain extender (Figure 12) in the biosynthesis of polyketides³⁰ and may be named propionate units.

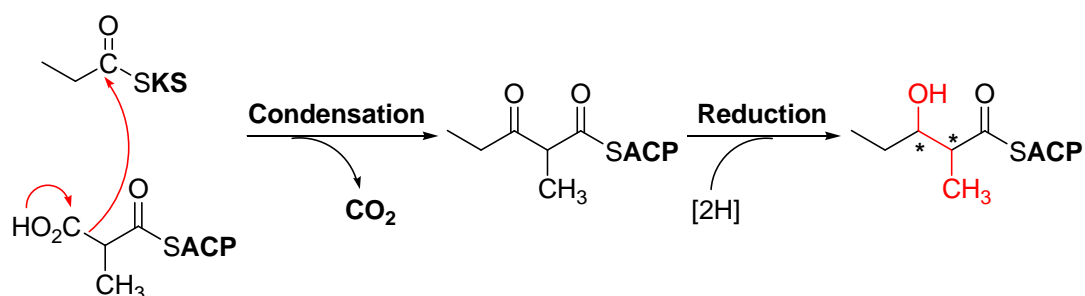


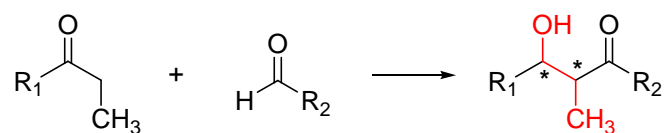
Figure 12 Biosynthesis of propionate units.

Synthetically, many stereocontrolled reactions and methods are established to introduce such propionate units in a stereospecific manner. They include: (i) auxiliary-controlled aldol reactions; (ii) asymmetric crotylation reactions; (iii) addition of chiral allenylzinc and indium reagents to aldehydes; (iv) epoxide opening; (v) 2,3-*Wittig* sigmatropic rearrangement; (vi) diastereoselective *anti*-S_N2' allylic displacement reactions. These various methods will be discussed in this section.

2.2.1 Auxiliary-Controlled Diastereoselective Aldol Reactions

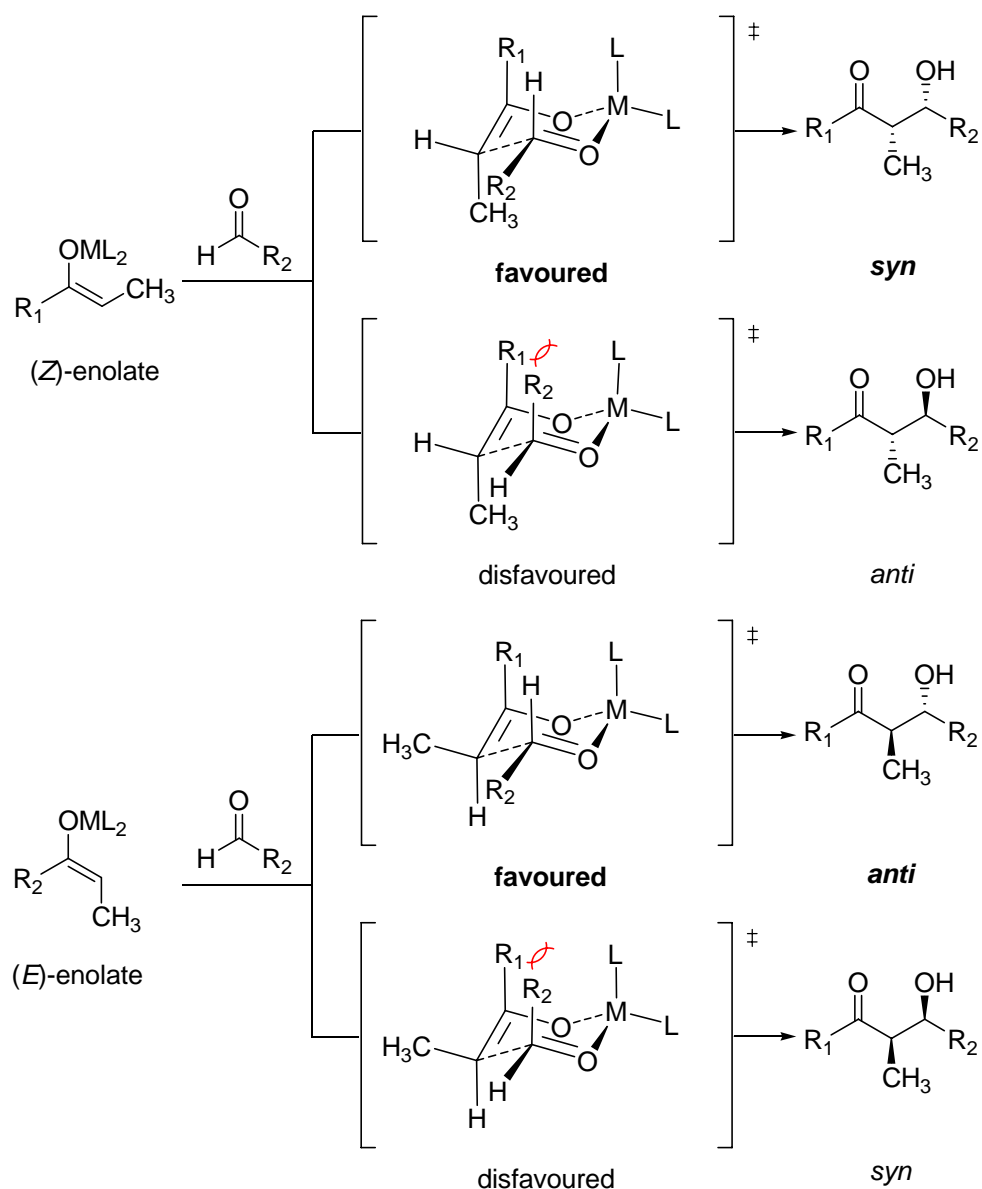
The aldol addition reaction is one of the most versatile C–C bond forming processes available to synthetic chemists. The addition reaction involves readily accessible starting materials and can provide β -hydroxy carbonyl adducts possessing new stereocenters (Scheme 1).

Nowadays, many auxiliary-controlled diastereoselective aldol reactions are available for the stereoselective synthesis of a variety of possible stereogenic permutations of propionate aldol additions in various polyketides.



Scheme 1 Propionate aldol additions.

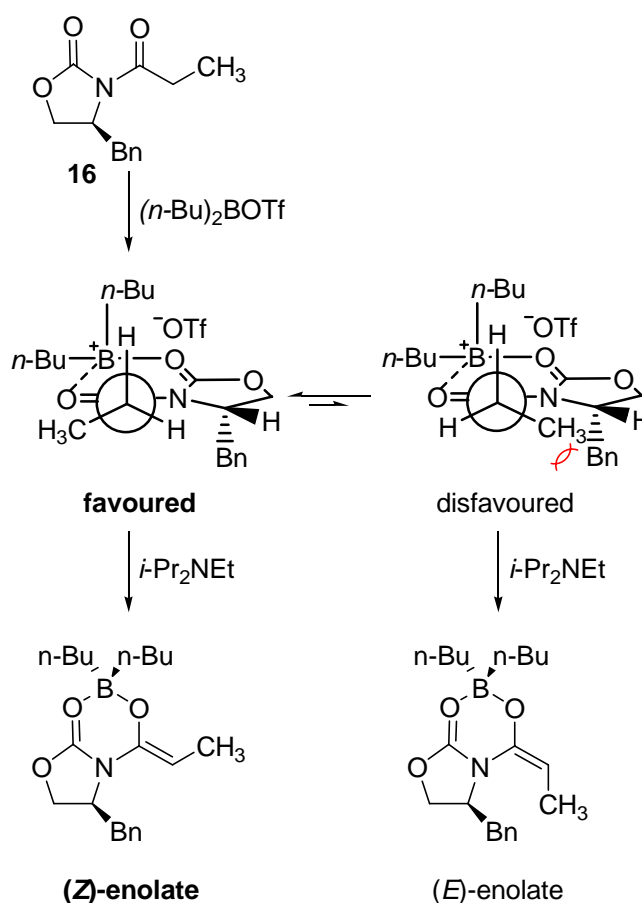
The relative configuration of the aldol adduct is determined by the geometry of the enolate component, (*Z*)-enolates giving *syn* products and (*E*)-enolates *anti* products. This may be rationalized via *Zimmerman-Traxler* transition states by minimizing 1,3-diaxial interactions between R_1 and R_2 in each chair-like transition state TS^\ddagger (Scheme 2)³¹. In practice, the stereochemistry can be highly metal dependent.

Scheme 2 *Zimmerman-Traxler* transition states for aldol reaction.

Thus, the enolization step is of prime importance in this type of additions, and reaction conditions were developed to generate either the *Z*- or the *E*-enolate. Auxiliary-controlled diastereoselective aldol reactions with various enolization concepts will first be discussed within this chapter.

2.2.1.1 Evans *syn* Aldol Reaction

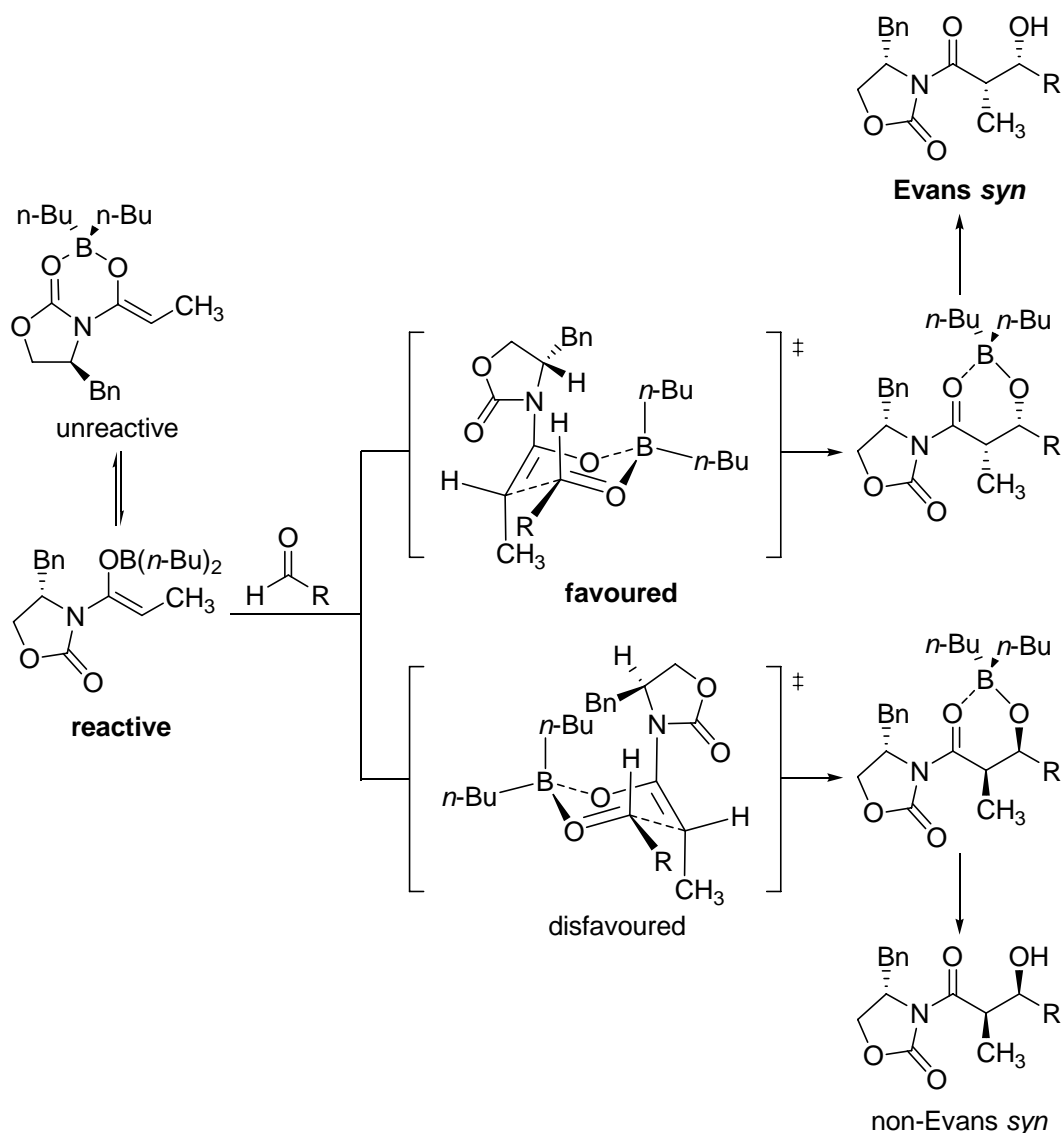
One of the most successful and widely used methods for auxiliary-controlled diastereoselective aldol addition reaction employs Evans' imides like **16** and the derived dialkyl borylenolates.³² The Evans' *syn* aldol adducts are typically isolated in high diastereoisomeric purity (>250:1 dr) and useful yield.



Scheme 3 Enolization of Evans' imide **16**.

As shown in scheme 3, enolization with dialkylboron triflates typically affords (*Z*)-enolates. One suspects that the transition state for deprotonation from the (**Z**)-enolate conformation (Scheme, 3) would be destabilized by 1,3-allylic strain interactions between the methyl group

and the substituents of the nitrogen atom. The carbonyl-carbonyl dipole interactions within the imide are minimized in the **reactive** conformation. Chiral controlled auxiliary biases enolate π -face such that one of the two diastereomeric *syn* transition states is greatly favoured (Scheme 4).³³

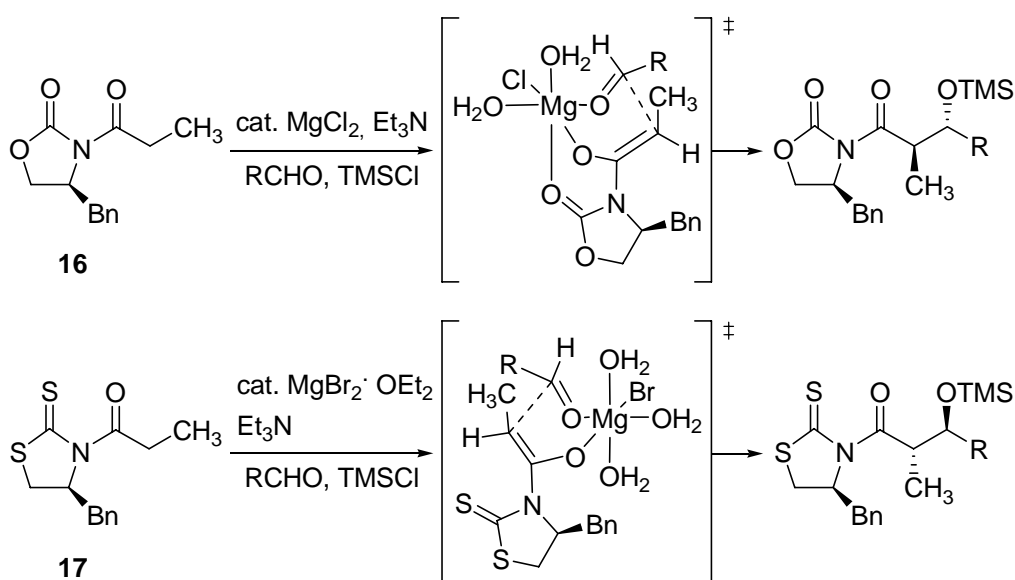


Scheme 4 *Evans syn* aldol reaction.

For the modification to the *Evans syn* aldol reaction, *Heathcock* developed a bimetallic intermediate aldol reaction. With the $n\text{Bu}_2\text{BOTf}/\text{TiCl}_4$ system, *non-Evans' syn* aldol adducts would be achieved. The $n\text{Bu}_2\text{BOTf}/\text{Et}_2\text{AlCl}$ system in turn provides *non-Evans' anti* aldol adducts.³⁴ *Crimmins* has reported the use of acyloxazolidinethione auxiliaries and TiCl_4 for the preparation of either *syn* aldol adducts as a function of the stoichiometry of the amine base and metal.³⁵

2.2.1.2 *Evans anti Aldol Reaction*

As shown in Scheme 5, *Evans* has reported a highly diastereoselective direct *anti*-aldol reaction with chiral *N*-acyloxazolidinone **16** promoted by catalytic amounts of MgCl_2 in the presence of triethylamine and chlorotrimethylsilane.³⁶ Only aromatic and unsaturated aldehydes are suitable substrates for this reaction. This method, however, does not allow β -branching on the acyl substituent. Later, the extension of this methodology to chiral *N*-acylthiazolidinethione **17** was described also by *Evans*.³⁷ Use of this method affords aldol products with the opposite *anti*-diastereoselectivity. The yield, diastereomeric ratio and substrate scope are comparable to the MgCl_2 catalyzed *anti*-aldol reactions of chiral *N*-acyloxazolidinones.

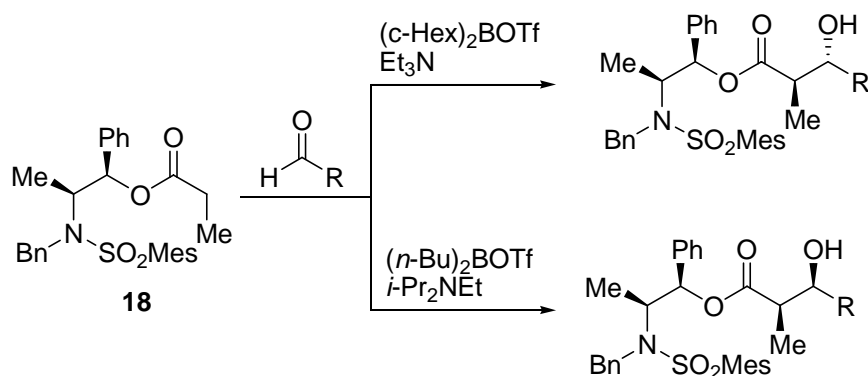


Scheme 5 *Evans anti aldol reaction.*

On the basis of the weight of circumstantial evidence, all enolization procedures to date to form boron, titanium, lithium, or sodium enolates with this family of imides implicate the intervention of (*Z*) metal enolates. Given the assumption that this is the geometry of the intervening enolate, the enolate face selectivity observed for the *N*-acyloxazolidinone-derived magnesium enolate is fully consistent with a chelate-controlled process. The intervention of a chair *Zimmerman-Traxler* transition state is precluded.³¹

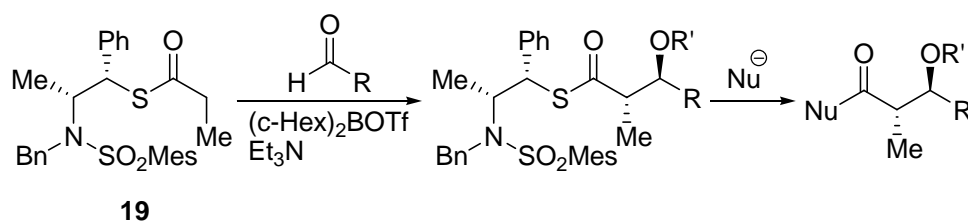
2.2.1.3 *Abiko-Masamune Aldol Reaction*

The boron-mediated aldol reaction of carboxylic ester **18** is shown to be particularly interesting and it is useful that the stereochemistry of the intermediate enolate can be controlled by the judicious choice of the enolization conditions. As shown in Scheme 6, enolization of the propionate ester **18** with $(c\text{Hex})_2\text{BOTf}$ and Et_3N provide *anti* aldol adducts,³⁸ on the contrary, with $(n\text{Bu})_2\text{BOTf}$ and $i\text{Pr}_2\text{NEt}$ *syn* aldol adducts are formed.³⁹ This implies that the conformations of the transition states leading to *anti*-aldol from (*E*)-enolate and *syn*-aldol from (*Z*)-enolate are different.



Scheme 6 *Abiko-Masamune* aldol reaction.

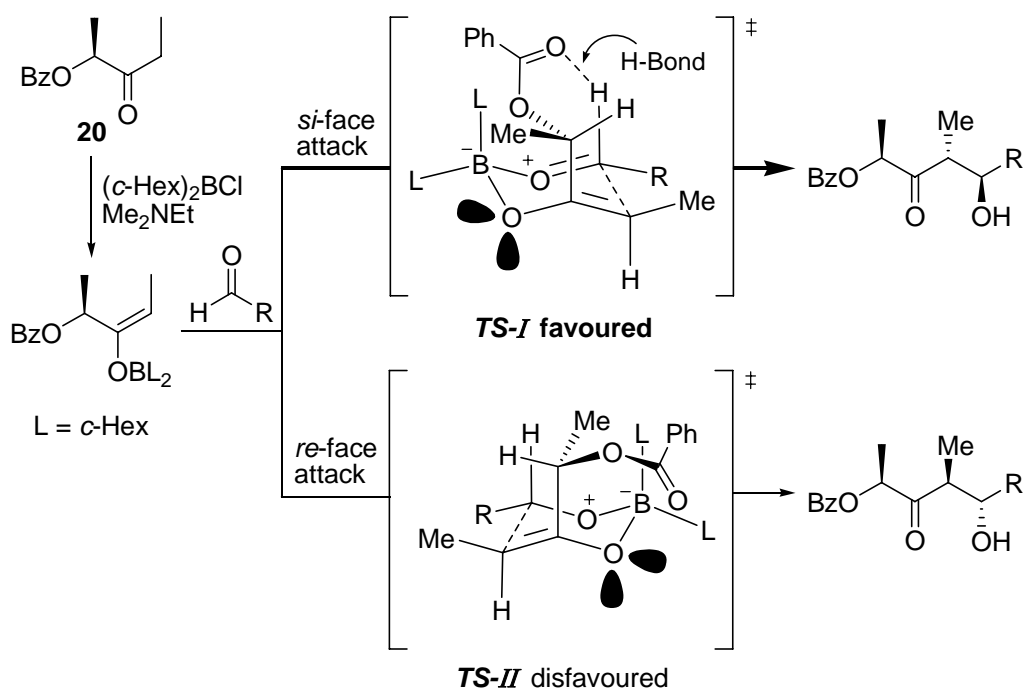
Hulme has modified *Abiko-Masamune* aldol reaction with a thiol surrogate **19** for the conventional auxiliary (Scheme 7).⁴⁰ This modified *anti* selective aldol reaction provide similar diastereoselectivities and yields. In comparison to *Abiko-Masamune* norephedrine-derived auxiliary **18**, this new thiol auxiliary **19** promotes facile displacement with a range of nucleophiles.



Scheme 7 Modified *Abiko-Masamune* aldol reaction.

2.2.1.4 Paterson Aldol Reaction

The lactate-derived keton **20**, as developed by the group of *Paterson*, displays high levels of stereocontrol in boron-mediated *anti* aldol reactions.⁴¹ The origin of the high levels of π -face selectivity in the reactions of keton **20** can be traced to the relative steric and electronic contributions of the substituents (H, Me, OBz) at the enolate stereocentre in the chair transition state for the aldol addition (Scheme 8). For such (*E*)-enol borinates, there is a strong preference for the proton to eclipse the double bond to minimise $A^{(1,3)}$ allylic strain. In the competing transition structures, *TS-I* and *TS-II*, the benzoate group is directed either inwards or outwards of the chair arrangement. In *TS-II* (*re*-face attack on aldehyde), there is likely to be a destabilising lone-pair repulsion between the benzoate and enolate oxygens. *TS-I* (*si*-face attack on aldehyde) may be favoured due to a stabilising H-bond between the benzoate oxygen with the aldehyde proton. Taken together, this analysis accounts for the apparent contra-steric preference for the benzoate to occupy the inside position.⁴²



Scheme 8 *Paterson* anti-aldol reaction.

The related lactate-derived ketones, **21**,⁴³ **22**⁴⁴ and **23**⁴⁵ are also useful auxiliaries for diastereoselective aldol reactions.

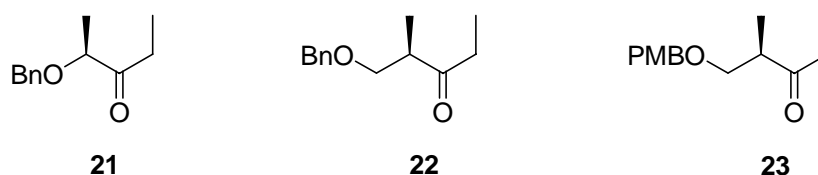


Figure 13 Related lactate-derived ketones for diastereoselective aldol reactions.

Oppolzer has reported *N*-propionylsultam **24** which undergoes *Lewis* acid promoted addition of aromatic and aliphatic aldehydes to give diastereomeric aldols⁴⁶ and used this method for the asymmetric synthesis of (-)-denticulatin A and B.⁴⁷

The camphor-derived chiral auxiliary **25** was studied by *Yan*.⁴⁸ Chiral boryl enolates of the camphor-derived auxiliary **25** are highly reactive and highly *anti*-stereoselective enolate synthon systems in aldol addition reactions promoted by a TiCl_4 or SnCl_4 co-catalyst. More significantly, this high-yield reaction exhibits remarkable generality with respect to the aldehyde nature, as illustrated by the rapid and *anti*-stereoselective aldolizations with the simple saturated and unsaturated aliphatic aldehydes, and aromatic aldehydes at temperatures as low as $-90\text{ }^\circ\text{C}$.

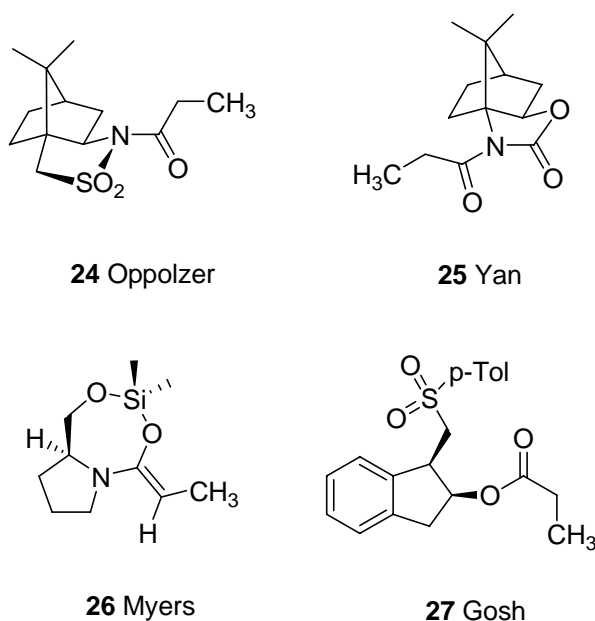


Figure 14 Further useful chiral auxiliaries for diastereoselective aldol reactions.

Myers has studied the chemistry of cyclic *O*-silyl ketene *N,O*-acetals **26** prepared from optically active (*S*)-prolinol propionamides and dichlorodimethylsilane.⁴⁹ *O*-silyl ketene *N,O*-acetals have been shown to undergo a facile and highly diastereoselective carbon-carbon bond-forming reaction with aldehydes.

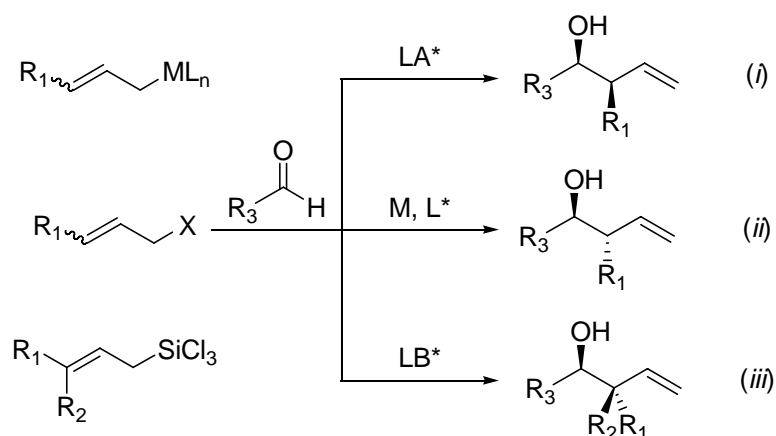
Gosh has reported amino indanol derived chiral esters such as **27** which provide titanium enolate aldol reactions with various aldehydes. This represents a highly effective synthetic protocol which gives excess of *anti*-aldol products with high levels of diastereo- and enantioselectivity.⁵⁰ Both enantiomers of *cis*-1-arylsulfonamido-2-indanol are readily prepared from commercially available optically active *cis*-1-amino-2-indanols.

2.2.2 Asymmetric Crotylation Reactions

Over the last decades, asymmetric allylation and crotylation reactions have been explosively developed and extensively used for the stereocontrolled assembly of polyketides. The allylmetal-aldehyde addition reaction has proven to be enormously successful for the construction of adjacent stereocentres. The reasons for the success of this method are (i) the high degree of enantio- and diastereoselection; (ii) the extreme diversity of reagent reactivity based on metal; (iii) the ability to access different stereodyads and triads; (iv) the inherent versatility of the obtained products towards further functionalization.⁵¹

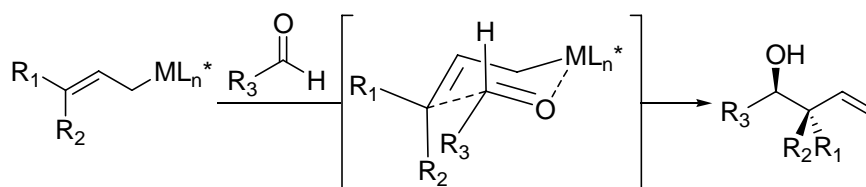
The asymmetric allylation and crotylation reactions can be classified into two groups: (i) stoichiometric asymmetric allylation and crotylation reactions and (ii) catalytic asymmetric allylation and crotylation reactions. Besides, one of the most intriguing features of these reactions is the dramatic relationship between the configuration of the product and the geometry of the starting alkene, dividing them into three mechanistically distinct types: **Type I** *syn/anti* diastereoselectivity reflects the *Z/E* ratio of the starting allylic geometry; **Type II** predominantly *syn* diastereoselective independent of the starting double bond configuration; **Type III** predominantly *anti* diastereoselective independent of the starting double bond configuration.⁵²

The catalytic asymmetric allylation and crotylation reactions can be grouped into three main categories (Scheme 9): (i) addition of allylic organometallic reagents (Si, Sn, B) catalyzed by chiral *Lewis* acids (LA*) (*type II*); (ii) addition of allylic organometallic reagents (Cr, Zn, In) generated *in situ* from the corresponding allylic halides catalyzed by chelating chiral ligands (L*) (*type III*), and (iii) addition of allylic trichlorosilanes catalyzed by chiral *Lewis* bases (LB*) (*type I*).⁵³



Scheme 9 The asymmetric allylation and crotylation reactions.

The stoichiometric asymmetric allylation and crotylation reactions belong to *type I* reactions. In this category excellent results have been obtained from the use of chiral modified allylic borane and allylic titanium reagents. Recently, the success of this approach has been extended to include allylic silanes and allylic stannanes⁵⁴ as well (Scheme 10).



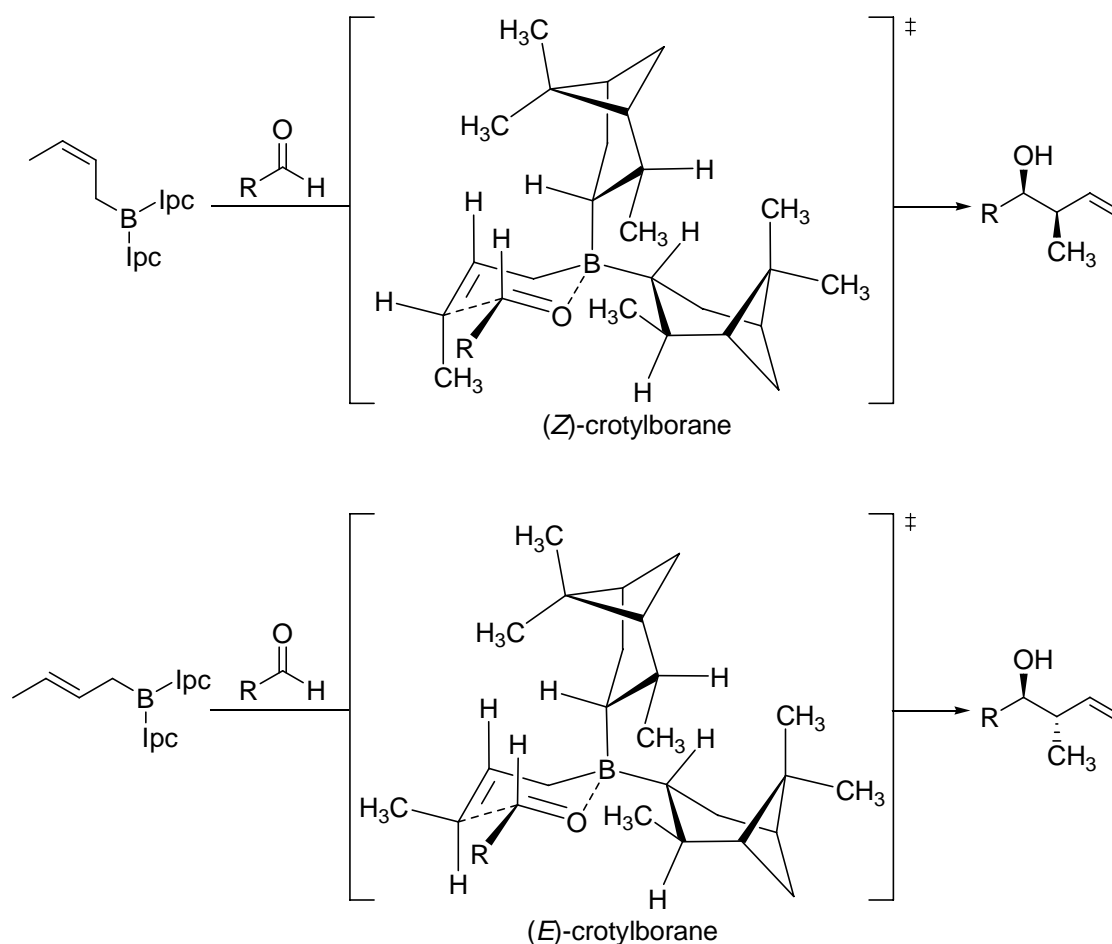
Scheme 10 Stoichiometric asymmetric allylation and crotylation reactions.

In the context of this dissertation, only stoichiometric asymmetric crotylation reactions will be discussed, as they are more generally used in natural product synthesis. For reviews on catalytic variants,^{55, 56} see Ref. 51(c), 53, 54, 55, 56.

2.2.2.1 *B*-Crotylation Reactions

Chiral allylic borane reagents are important in synthetic organic chemistry as reagents for acyclic stereocontrol and stereoselective annulation processes.⁵⁷ One effective and successfully used *B*-crotylation reaction is the *Brown B*-crotylation reaction.⁵⁸

The high stereospecificity has been explained by a closed chair-like transition state, where the boron is coordinated to the carbonyl oxygen. The aldehyde is oriented in such a manner that the R group is placed in an equatorial position of the chair to minimize steric interactions between the Ipc-group on boron and the allyl unit. This model explains the high degree of stereoselection observed when isomerically pure (*E*)- or (*Z*)-crotylboronates react with aldehydes. Thus, the (*E*)-crotyl isomer leads to the *anti* homoallylic alcohol while the (*Z*)-crotylboronate gives the *syn* product (scheme 11).

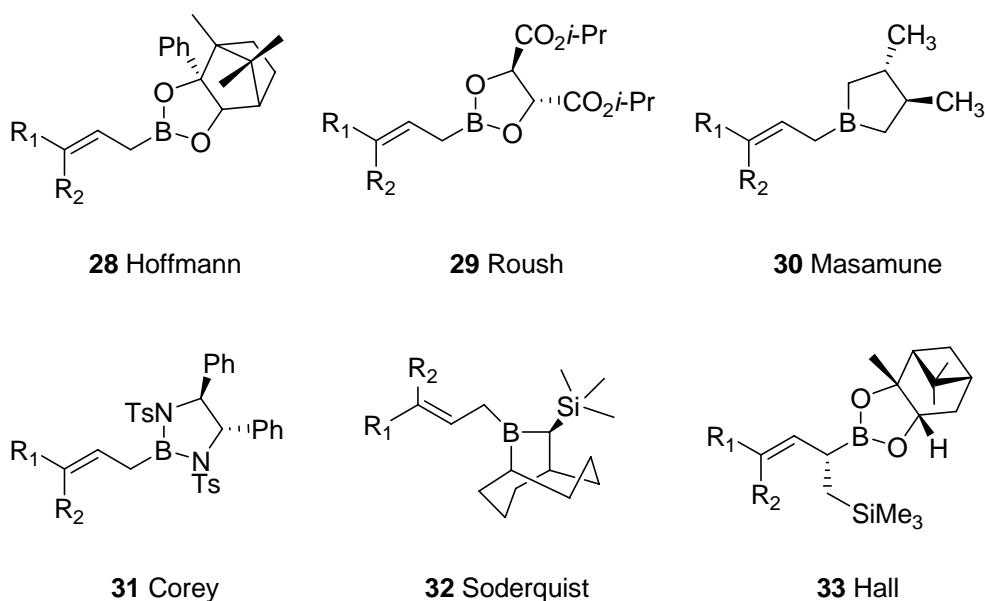


Scheme 11 *B*-crotylation reactions.

The transition state for the allylboration of carbonyl compounds have also been modelled with computer calculations. *Ab initio* calculations identified a strong preference for the chair-like arrangement of the two components in the addition of allylboranes to aldehydes, in close agreement with the experimental results.⁵⁹

Solvents have a significant effect on the rates of allylboration reactions.⁶⁰ Polar solvents, including chloroform, dichloromethane and diethylether, which are either poorly coordinating or non-coordinating, enhance the rate of allylboration, while solvents capable of stronger coordination with boron, such as tetrahydrofuran, retard the rate. Highly substituted aldehydes react significantly more slowly than less substituted aldehydes.

The high degree of organization that characterizes the putative transition state for the **Type I** reactions in that they proceed through closed transition states and do not require the use of an external *Lewis* acid, has stimulated the development of a myriad of modified chiral allylic boron reagents such as **28**,⁶¹ **29**,⁶² **30**,⁶³ **31**,⁶⁴ **32**,⁶⁵ and **33**⁶⁶ (Figure 15) for asymmetric crotylation of carbonyl compounds, as shown in Scheme 10.

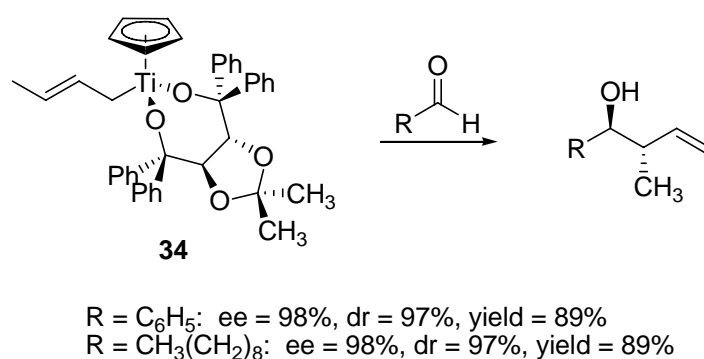


Z: $R_1 = \text{H}$, $R_2 = \text{Me}$; E: $R_1 = \text{Me}$, $R_2 = \text{H}$

Figure 15 Modified chiral allylic boron reagents.

2.2.2.2 Duthaler-Hafner Ti-Crotylation Reactions

The chiral crotyltitanium complexes such as **34** (Scheme 12)⁶⁷ are prepared from readily available nontoxic materials; the source of chirality, tartaric acid, is available in both enantiomeric forms. Contrary to crotylboron reagents, these crotyltitanium compounds can be prepared by transmetalation with a variety of crotyl Grignard, crotyllithium and crotylpotassium/-lithium compounds and isolation or purification is not necessary. In addition, their potential for large-scale conversions is better than that of any other stoichiometric chiral crotyl-transferring reagent known.

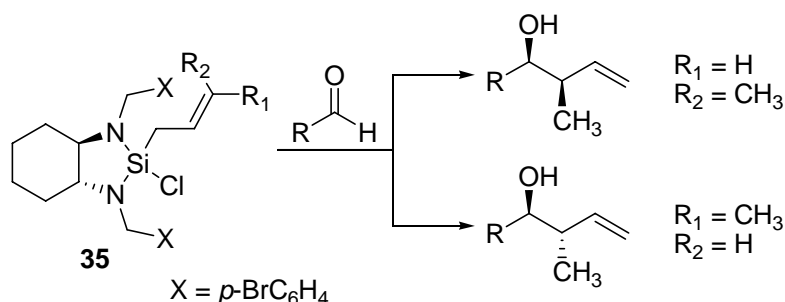


Scheme 12 Duthaler-Hafner Ti-crotylation reactions.

The reactions of the crotyltitanium compound **34** with benzaldehyde and decanal are highly enantio- and diastereoselective, affording the homoallylic alcohol in excellent yield (Scheme 12). The major product in all cases is the anti diastereomer, obtained by attack on the *Si* face of the substituted terminus of the crotyltitanium complex. On the other hand, NMR analysis of the crotyl reagents (crotyl Grignard, crotyllithium, and crotylpotassium/-lithium) revealed a fast 1,3-migration of titanium, favoring the (*E*)-isomer with titanium η^1 bound to the unsubstituted terminus of the crotyl group. This explains the almost exclusive formation of the *anti* diastereomers, a clear restriction of this method.⁶⁸

2.2.2.3 Leighton Si-Crotylation Reactions

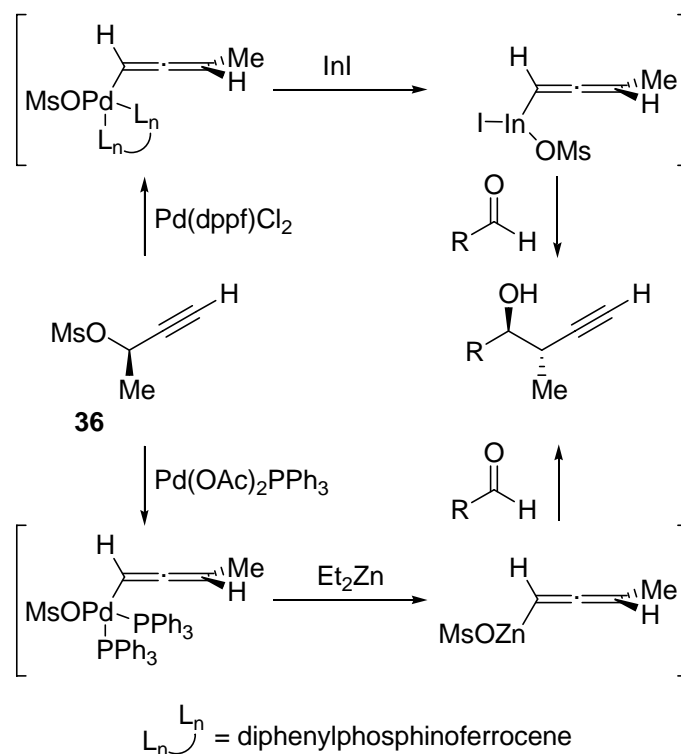
The *cis*- and *trans*-crotylsilane reagents **35** (Scheme 13) are easily prepared in bulk and are storable crystalline solids, even though their synthesis requires a few steps. A survey of the performance of crotylsilane reagents was carried out with a variety of aliphatic, aromatic, and α,β -unsaturated aldehydes. In every case, the *cis*- and *trans*-crotylsilane reagents demonstrated their use in highly enantioselective *syn*- and *anti*-selective aldehyde crotylation reactions, respectively. The crotylation reactions are experimentally trivial and the chiral diamine controller may be easily recovered in high yield.⁶⁹



Scheme 13 Leighton Si-crotylation reactions.

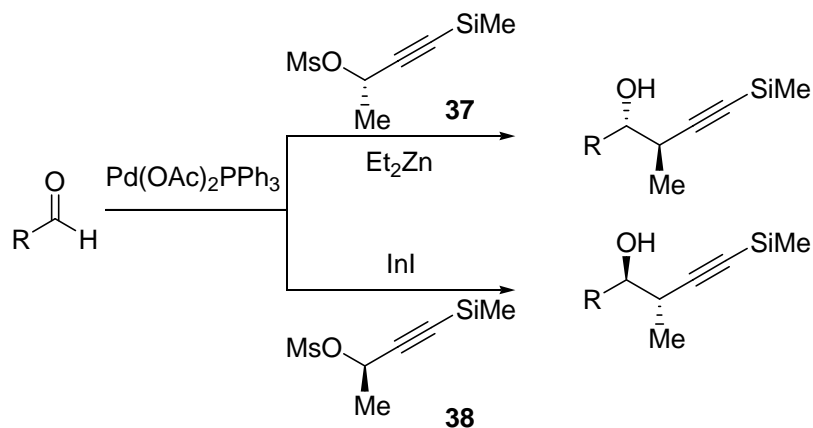
2.2.3 Addition of Chiral Allenylzinc and Indium Reagents to Aldehydes

Marshall has reported a methodology for preparing nonracemic homopropargylic alcohols from enantioenriched propargylic mesylates such as **36** as precursors to chiral allenylzinc⁷⁰ or indium reagents⁷¹ for the coupling to aldehydes. These reagents are generated *in situ* through “oxidative transmetalation” of transient allenylpalladium intermediates (Scheme 14).⁷² In fact, when the reaction is performed on allenylzinc reagent in the presence of various aliphatic aldehydes, homopropargylic alcohol adducts of 86-96% ee are isolated in high yield. The diastereoselectivity of the addition with allenylindium reagent is similar to that with allenylzinc reagent.



Scheme 14 Addition of chiral allenylzinc and indium reagents from **36** to aldehydes.

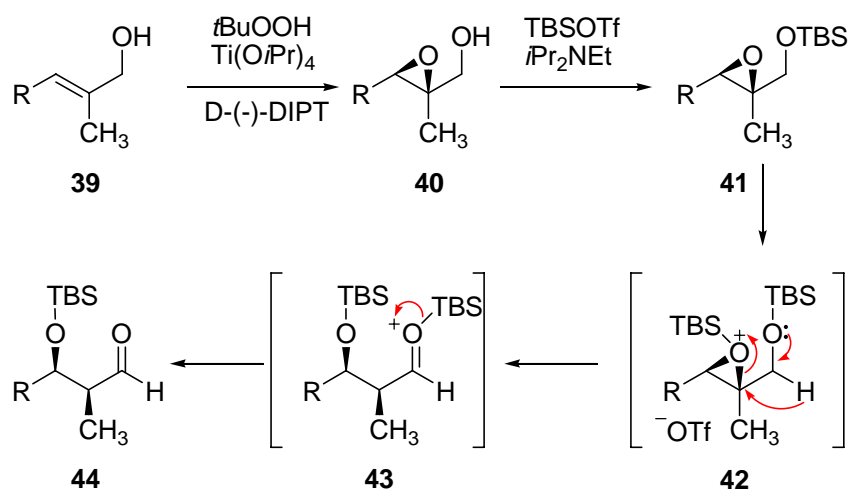
Later, *Marshall* published other addition reactions of aldehydes with allenylzinc or indium reagent which are generated *in situ* with **37** or **38** and Et₂Zn or InI in the presence of Pd(OAc)₂PPh₃ (Scheme 15).⁷³ The additions of aldehydes with α -TMS-substituted allenylzinc reagents proceed with excellent diastereoselectivity and only slight loss of enantioselectivity. In contrast, the additions of aldehydes with α -TMS-substituted allenylindium reagents afford *anti* products with er values of 99:1 or higher and with virtually no trace of *syn* products.



Scheme 15 Addition of chiral allenylzinc and indium reagents from **37** and **38** to aldehydes.

2.2.4 Epoxide Opening

Allylic alcohols such as **39** may be easily converted into the optically active epoxy alcohols like **40** using the D-(-)-diisopropyl tartrate [D-(-)-DIPT] as the chiral catalyst following the *Sharpless* method. Treatment of the epoxy alcohol **40** with *Lewis* acid such as TBSOTf, TESOTf or BF₃ provides the *syn* aldol product in high yield and excellent enantioselectivity. The proposed mechanism of this transformation involves activation of the epoxide oxygen with *Lewis* acid followed by intramolecular hydride transfer as shown in **42** to generate the new stereocenter at the methyl substituted carbon in **43**. The *Lewis* acid may then decoordinate to give the product **44** (Scheme 16).⁷⁴ The (*E*)-allylic alcohols give the *syn* products, while the (*Z*)-allylic alcohol afford the *anti* products.

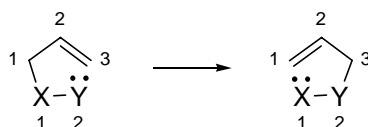


Scheme 16 Stereoselective epoxide opening with *Lewis* acid.

An application of this nonaldol-aldol methodology in the total synthesis of polyketides has also been reported.⁷⁵

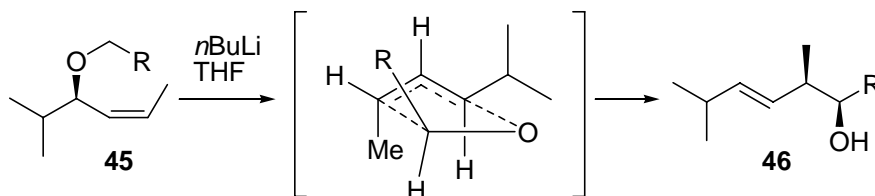
2.2.5 2,3-Wittig Sigmatropic Rearrangement

[2,3]-sigmatropic rearrangements constitute an exceptionally versatile type of bond reorganization which have many applications in organic synthesis. Acyclic stereocontrol is particularly pronounced. The [2,3]-sigmatropic reaction, as generalized in Scheme 17, can be defined as a thermal isomerization that proceeds through a six-electron, five-membered cyclic transition state.⁷⁶



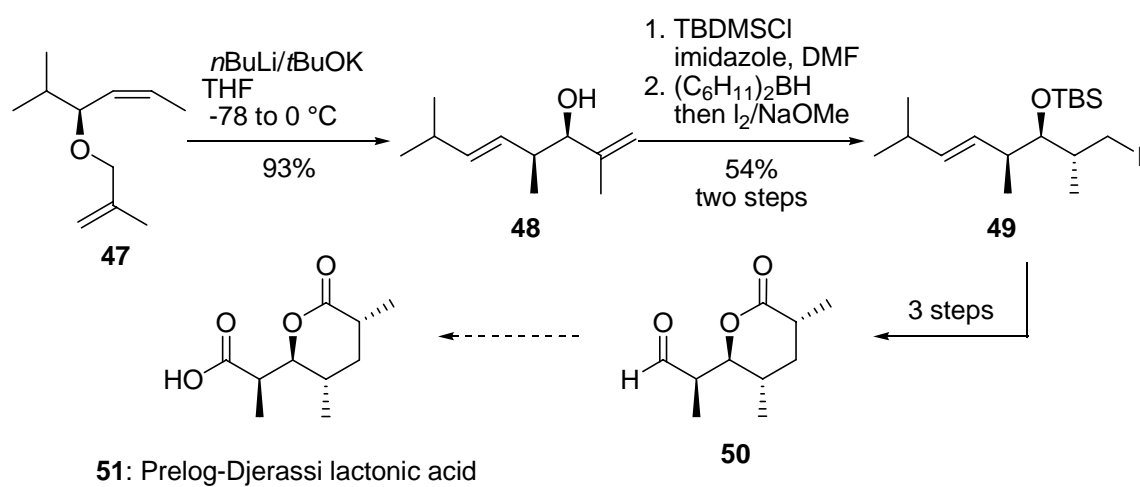
Scheme 17 The [2,3]-sigmatropic rearrangement reaction.

Midland has reported that the [2,3]-*Wittig* rearrangement of optically active (*Z*)-allylic ether **45** provides allylic alcohol **46** with complete control of olefin geometry and chirality transfer and a high degree of diastereoselectivity. Probably, the relative stereochemistry is fixed with a high degree of control by way of a five-membered cyclic transition state. For the rearrangement of (*Z*)-allylic ethers, the isopropyl group is less hindered in the equatorial position and leads to the (*E*)-olefin with a high degree of stereoselectivity (Scheme 18).⁷⁷

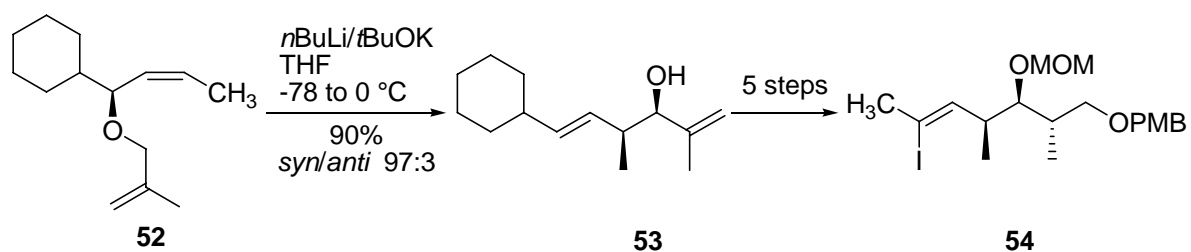


Scheme 18 The [2,3]-*Wittig* rearrangement of (*Z*)-allylic ethers.

Midland has also used this reaction for synthesis of the (+)-*Prelog-Djerassi* lactone **50** from (*Z*)-allylic ether **47** (Scheme 19).⁷⁸

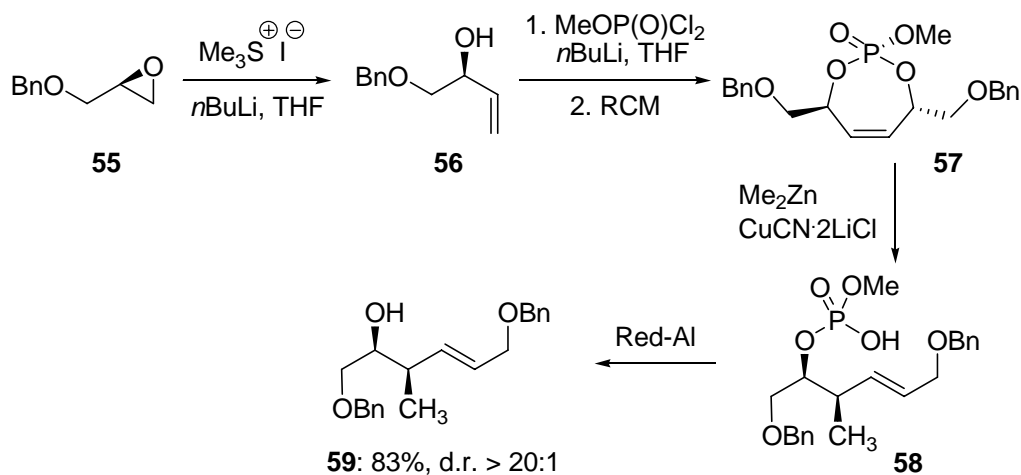
Scheme 19 Synthesis of (+)-Prelog-Djerassi lactone **50**.

Recently, the application of the [2,3]-Wittig rearrangement reactions of (*Z*)-allylic ether **52** via the cyclohexanecarboxaldehyde-derived intermediate for synthesis of polypropionate building block **54** was described by *Parker* (Scheme 20).⁷⁹

Scheme 20 Synthesis of polypropionate building block **54**.

2.2.6 Diastereoselective anti-S_N2' allylic Displacement Reactions

Hanson has reported a strategy employing phosphate tethers **57** in which a phosphate ester serves a dual role as both tether for coupling two allylic alcohols **56** via ring closing metathesis (RCM) and as a subsequent leaving group in selective *anti*-S_N2' displacement reactions with organocuprate nucleophiles (Scheme 21). *Syn*-(*E*)-homoallylic alcohol **59** as product was achieved in high yield and diastereoselectivity.⁸⁰



Scheme 21 Synthesis of *syn*-(*E*)-homoallylic alcohol **59**.

The remarkable selectivity for this transformation can be rationalized using Corey's proposed concerted, asynchronous mechanism⁸¹ for cuprate additions as highlighted in Figure 16. In this mechanism, the reacting cuprate simultaneously coordinates both the π^* orbital of the olefin and σ^* orbital of the phosphate ester leaving group. The asynchronous nature of the transformation predicts a transition state in which substantial bond-lengthening occurs with respect to the σ^* bonding orbital.

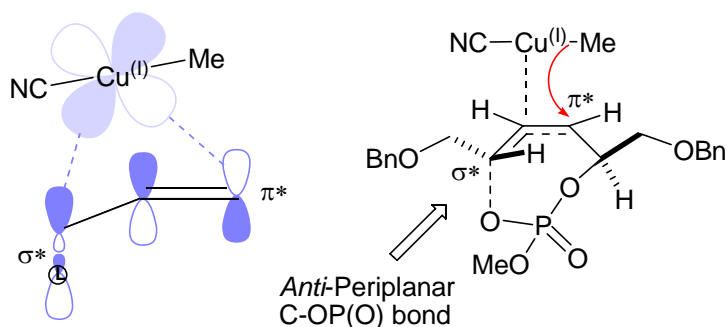


Figure 16 Corey model for rationalizing stereoselectivity.

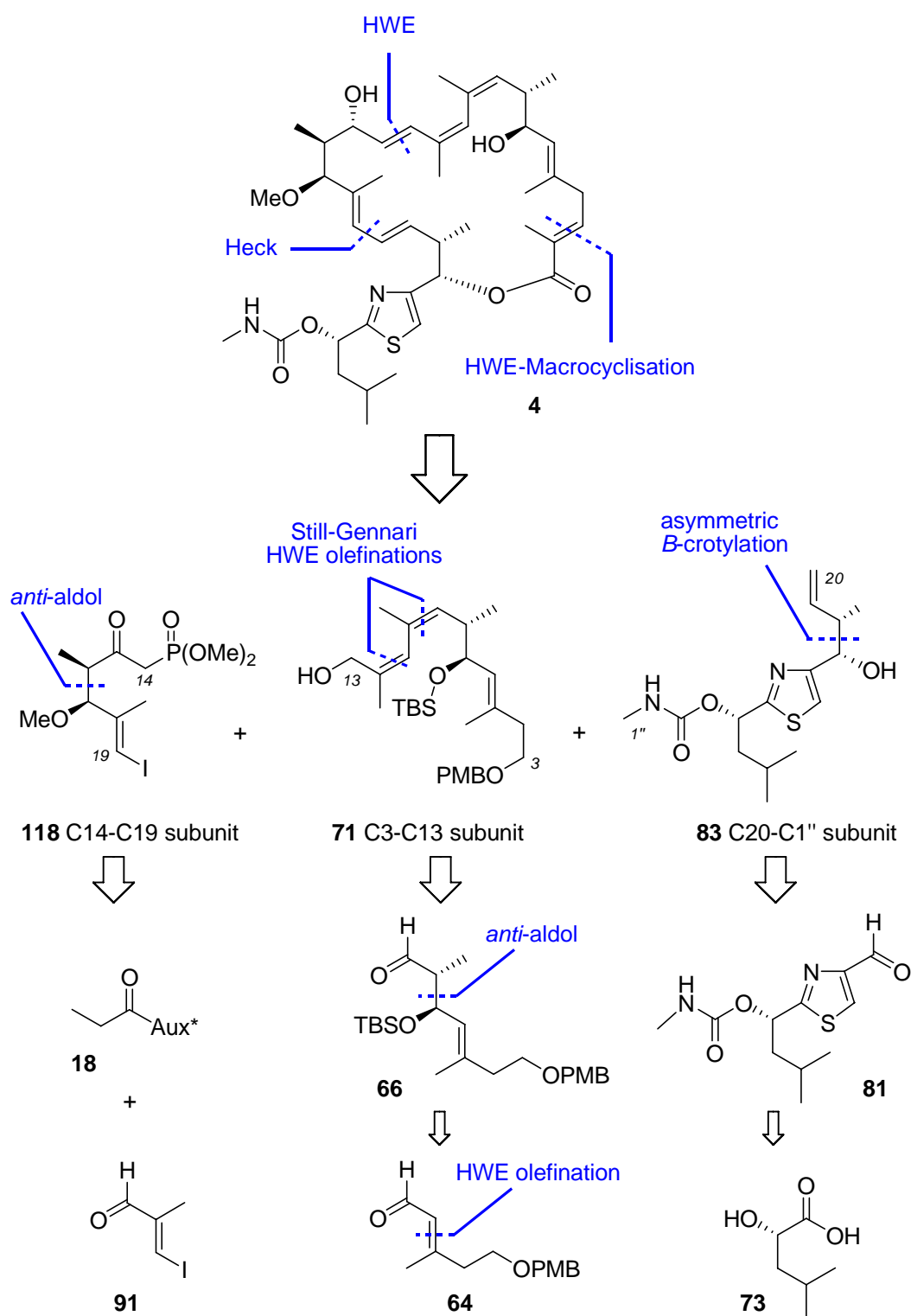
3 Total Synthesis of Archazolids

3.1 Retrosynthetic Analysis

As outlined retrosynthetically in Scheme 22, our synthetic approach relies on the assembly of three main building blocks of similar complexity, that is **118**, **71**, and **83**. The 13*E*-alkene moiety was planned to arise from a *Horner-Wadsworth-Emmons* (*HWE*) reaction between the corresponding ketophosphonate **118** and a respective aldehyde derived from **71**, while a *Heck* cross-coupling of **118** with alkene **83** was envisioned to deliver the 18*E*,20*E*-diene. In principle, this methodology could be employed to close the macrocycle as an alternative to a *Horner-Wadsworth-Emmons* macrocyclization or a more conventional *Yamaguchi* reaction for ring closure, thus offering considerable flexibility in the synthesis.

In turn, the C14-C19 subunit **118** should be accessible by an auxiliary-controlled diastereoselective aldol reaction between ethyl ketone **18** and aldehyde **91** containing the required *E* vinyl iodide. The C3-C13 fragment **71** was envisioned to be derived from **66** by two consecutive *Still-Gennari* olefinations. Intermediate **66** in turn should be accessible from aldehyde **64** by *anti*-aldol methodology. The enal **64** could be prepared by using *Horner-Wadsworth-Emmons* olefination. The C20-C1'' subunit **83** was planned to be derived by asymmetric *B*-crotylation from aldehyde **81**, which in turn should be accessible from L-Leucin derived α -hydroxy-acid **73**.

Notably, the modular synthetic approach employed is flexible, highly convergent, and stereocontrolled, and thus offers the potential to provide useful quantities of archazolid A (**4**) as well as a range of structural derivatives for structure-activity relationship (SAR) studies. Key issues to be addressed include (i) two auxiliary-controlled diastereoselective aldol reactions; (ii) an asymmetric *B*-crotylation reaction; (iii) two consecutive *Still-Gennari* olefinations reactions; (iv) *HWE*-olefination; (v) inter-molecular *Heck*-coupling reaction; (vi) *HWE*-macrocyclization or macrolactonation.

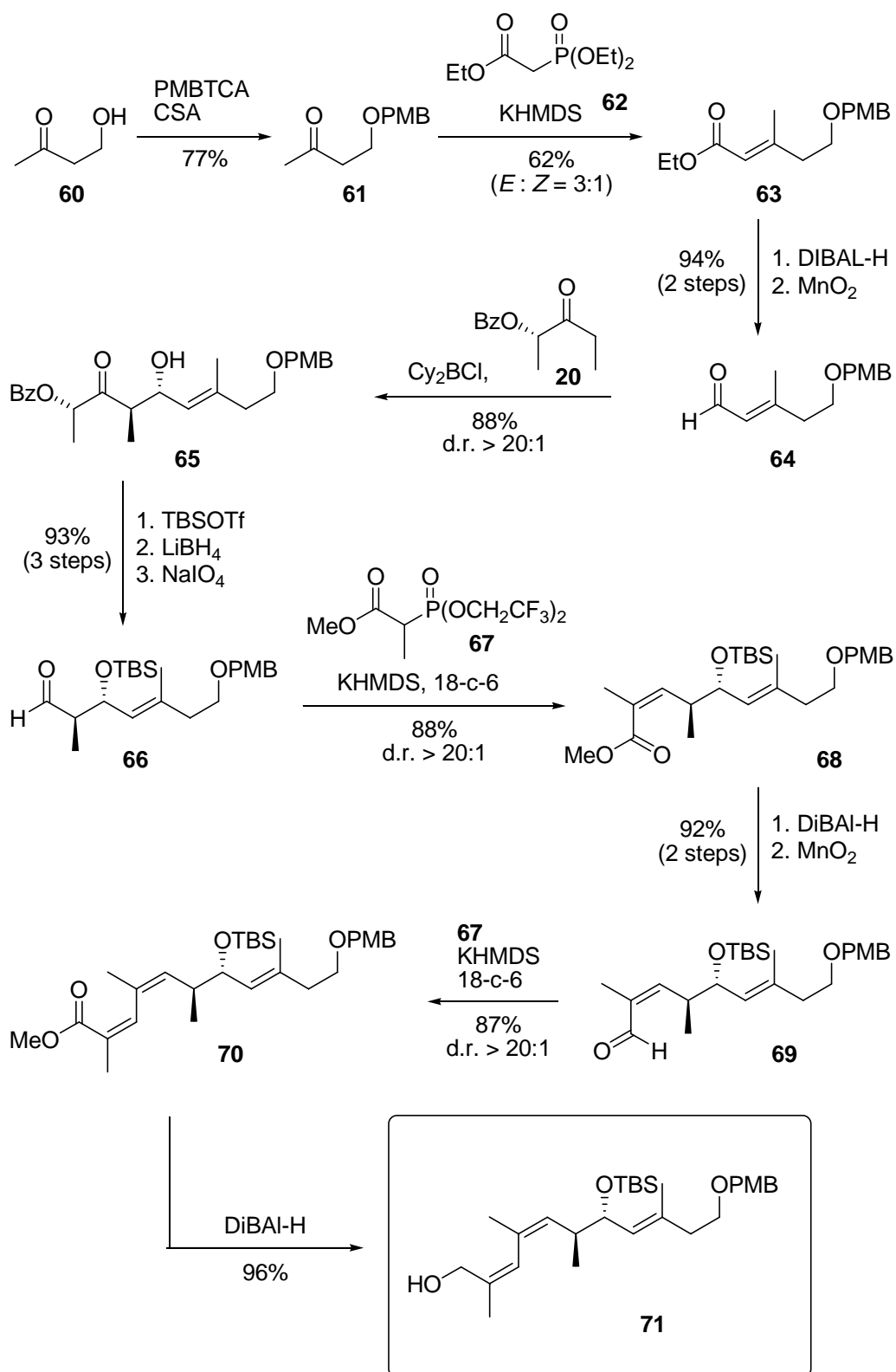


Scheme 22 Retrosynthetic analysis for archazolid A (**4**), leading to three main key building blocks **118**, **71**, and **83**.

3.2 Synthesis of the C3-C13 Subunit – Dr. *Jorma Hassfeld*

The synthesis of the C3-C13 subunit **71** was realised by *Jorma Hassfeld* in our group. As shown in Scheme 23, it began with PMB ether **61** of acetone-aldol **60**,⁸² which was homologated to **63** with the corresponding β -keto-phosphonate **62** using a *HWE* coupling employing KHMDS in toluene.⁸³ The corresponding aldehyde **64** was readily available by a two step procedure using a reduction to the alcohol (DIBAL-H) and allylic oxidation (MnO₂) in 87% yield. A boron-mediated *Paterson anti* aldol reaction⁸⁴ of lactate-derived ethyl-ketone **20**⁴² with aldehyde **64** gave the secondary alcohol **65** with very high levels of diastereoselectivity and essentially quantitative yield. After TBS protection (TBSOTf, 2,6-lutidine), the chiral auxiliary was then cleaved in a straightforward fashion using a two-step sequence (LiBH₄, NaIO₄)⁸⁵ to give directly aldehyde **66** in 85% yield over three steps, which was subsequently submitted to a *Still-Gennari* modification⁸⁵ of the *HWE*-olefination with phosphonate **67**. Coupling of aldehyde **66** with phosphonate **67**, employing KHMDS as base in combination with 18-crown-6 gave *Z*-enone **68** in 87% yield as the only detectable isomer. The ester **68** was then converted into the enal **69** by DIBAL-H reduction and allylic oxidation using MnO₂. The required 11*E*-alkene was then installed by another *Still-Gennari* olefination, which proceeds again with very high levels of stereoselectivity (d.r. > 20:1). Finally, the synthesis of the C3-C13 subunit **71** was completed in two steps involving ester reduction (DIBAL-H) and oxidation of the resulting primary alcohol with *Dess-Martin* periodinane (DMP).

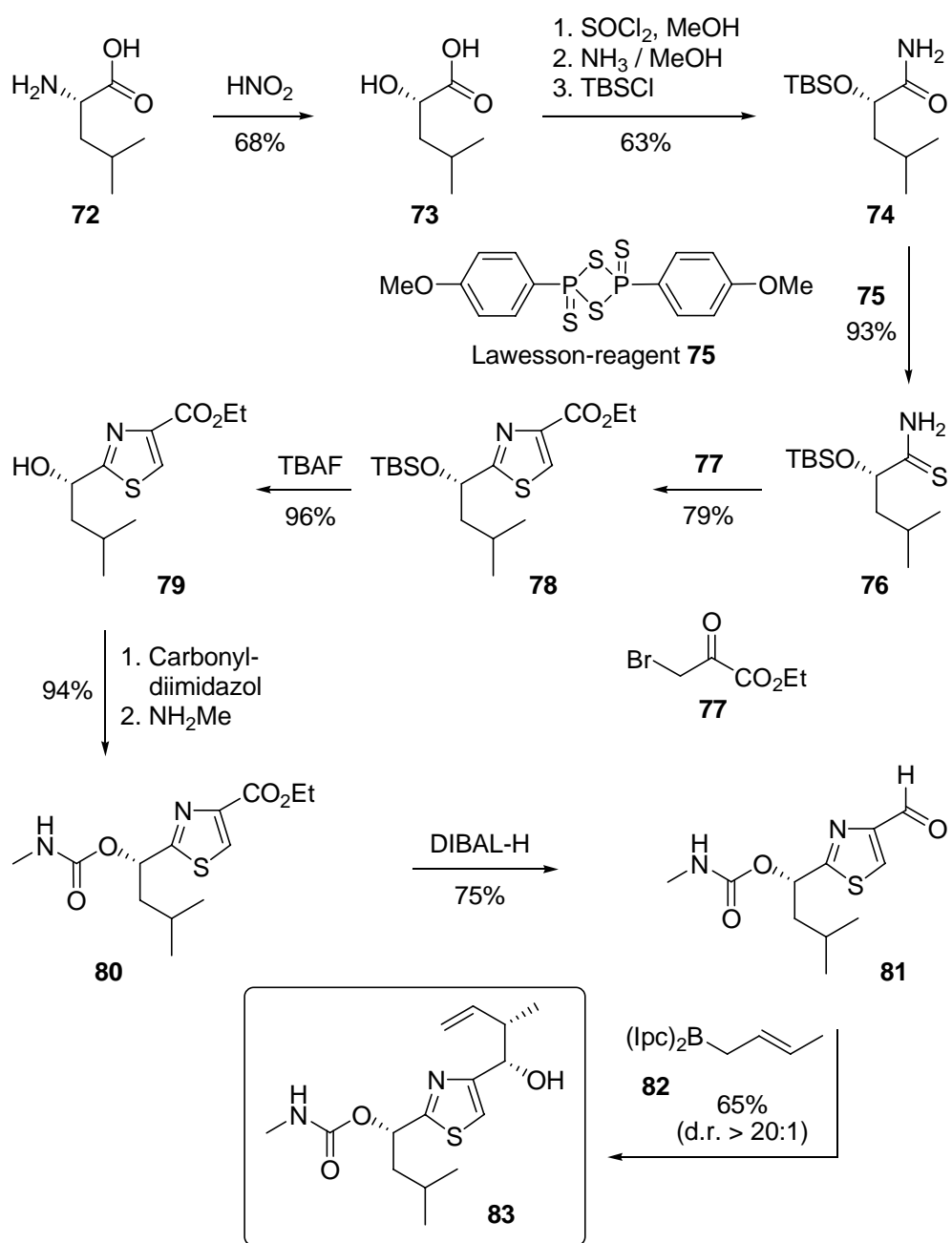
In summary, this route to the C3-C13 subunit **71** proved well-scalable and multigram quantities of required building block were obtained from **60** in 13 steps and 25% overall yield.

Scheme 23 Synthesis of the C3-C13 subunit **71**.

3.3 Synthesis of the C20-C1'' Subunit – *Sven Rudolph*

The preparation of the C11-C1'' subunit **83**, as realised by *Sven Rudolph* in our group is shown in Scheme 24. It starts with conversion of L-Leucin **72** to α -hydroxyacid **73**⁸⁶ which was then transformed into amide **74** in 63% yield by a three-step procedure involving formation of the acid chloride, introduction of the amide and TBS protection of the secondary alcohol. After treatment with the Lawesson reagent **75**,⁸⁷ the resulting thioamide **76** was cyclized with a bromo-oxo acid ethyl ester **77** to give thiazol **78** in 79% over two steps.⁸⁸ Cleavage of the TBS ether with TBAF liberated the secondary alcohol **79** in 96% yield. The carbamate was then introduced in a two step protocol by use of carbonylimidazol and trapping of the intermediate imide with methylamine.⁸⁹ DIBAL-H reduction of the resulting ester **80** gave aldehyde **81**, which was C3-homologated by using an asymmetric *Brown's* boron mediated crotylation⁹⁰ delivering **83** with excellent diastereoselectivity (d.r. > 20:1) and useful yield (65%).

In total, this fragment was available in 11 steps in 24% yield. Likewise, this route was well-scalable and allowed to obtain multi-gram quantities of the C11-C1'' subunit **83**.

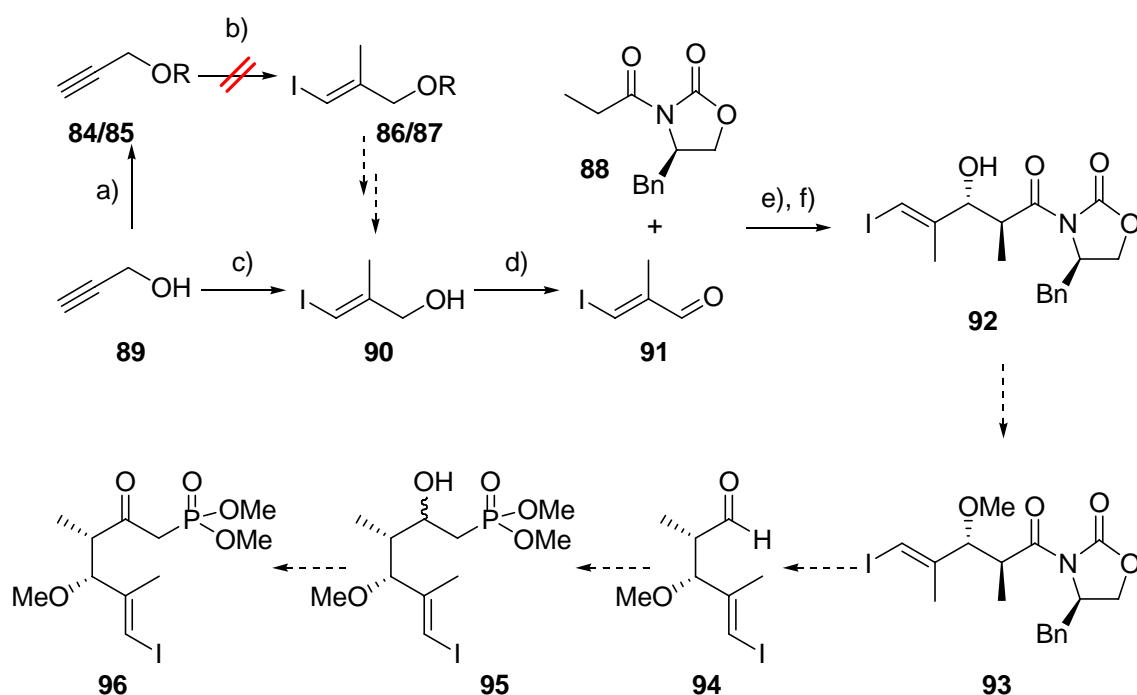
Scheme 24 Synthesis of the C20-C1' subunit **83**.

3.4 Synthesis of the C14-C19 Subunit

Synthesis of the C14-C19 subunit was realised within the research programme of this dissertation.

3.4.1 Plan 1: *Evans anti* Aldol Reaction

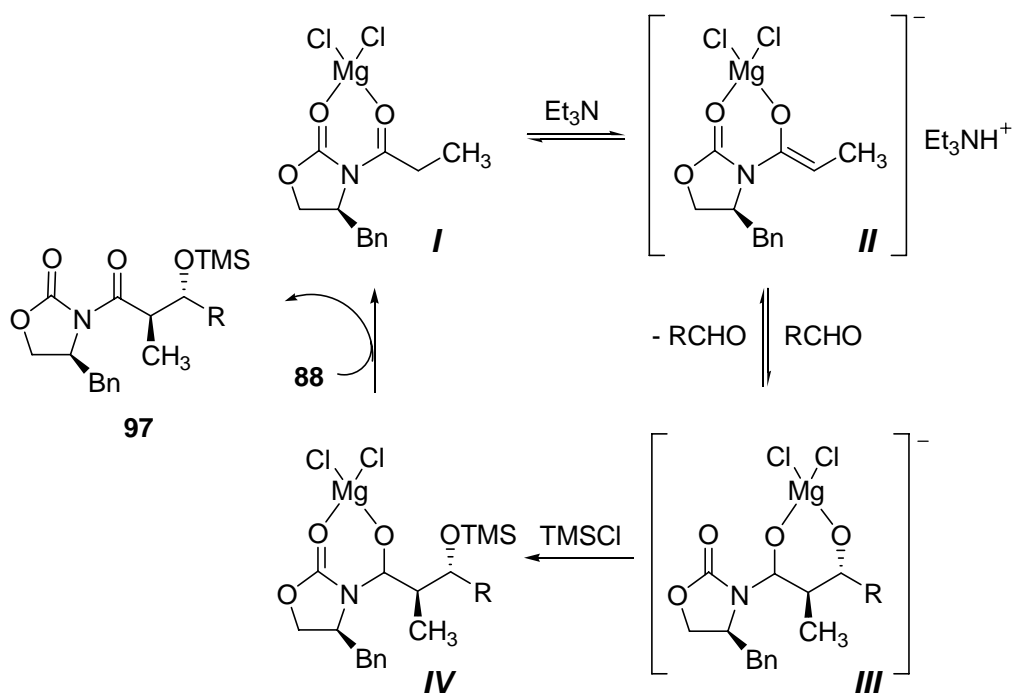
As the first plan, we wanted to establish the stereocentres at C16 and C17 by using a mild MgCl_2 -catalyzed *anti* aldol reaction that had been disclosed by *Evans*³⁶ and was first used in the total synthesis of (+)-migrastatin by *Danishefsky*.⁹¹



Scheme 25 (a) **84**: R = TBS, TBSCl, imidazol, DMAP, RT, 120 min, 82%; **85**: R = TBDPS, TBDPSCl, imidazol, DCM, RT, 30 min, 100%; (b) MeMgBr, $\text{CuBr}\cdot\text{SMe}_2$, I_2 , THF, $-45\text{ }^\circ\text{C}$; (c) Cp_2ZrCl , Me_3Al , DCM, $0\text{ }^\circ\text{C}$, then I_2 , Et_2O , $-30\text{ }^\circ\text{C}$, 22%, (d) MnO_2 , Et_2O , RT, 96%; (e) MgCl_2 , Et_3N , TMSCl, EtOAc, RT, 52 h; (f) MeOH, TFA, RT, 10 min, 29% over 2 steps, dr > 95:5.

The known aldehyde **91** was prepared by zirconation-methylation-iodination of propargyl alcohol **89**⁹² followed by oxidation of the allylic alcohol **90** with manganese dioxide. To our disappointment, the zirconation-methylation-iodination provided the allylic alcohol **90** in very low yield (22%). The carbocupration-methylation-iodination of the protected propargyl alcohol **84/85** with MeMgBr, $\text{CuBr}\cdot\text{SMe}_2$ and I_2 gave no desired product **86/87**.⁹³

Treatment of *Evans*-amide **88** with catalytic MgCl_2 , Et_3N as base, TMSCl and aldehyde **91** at RT for 52 h after cleavage of the TMS group with TFA in methanol gave the aldol product **92** with very good stereoselectivity, albeit in low yield (29% over two steps, d.r. > 20:1).

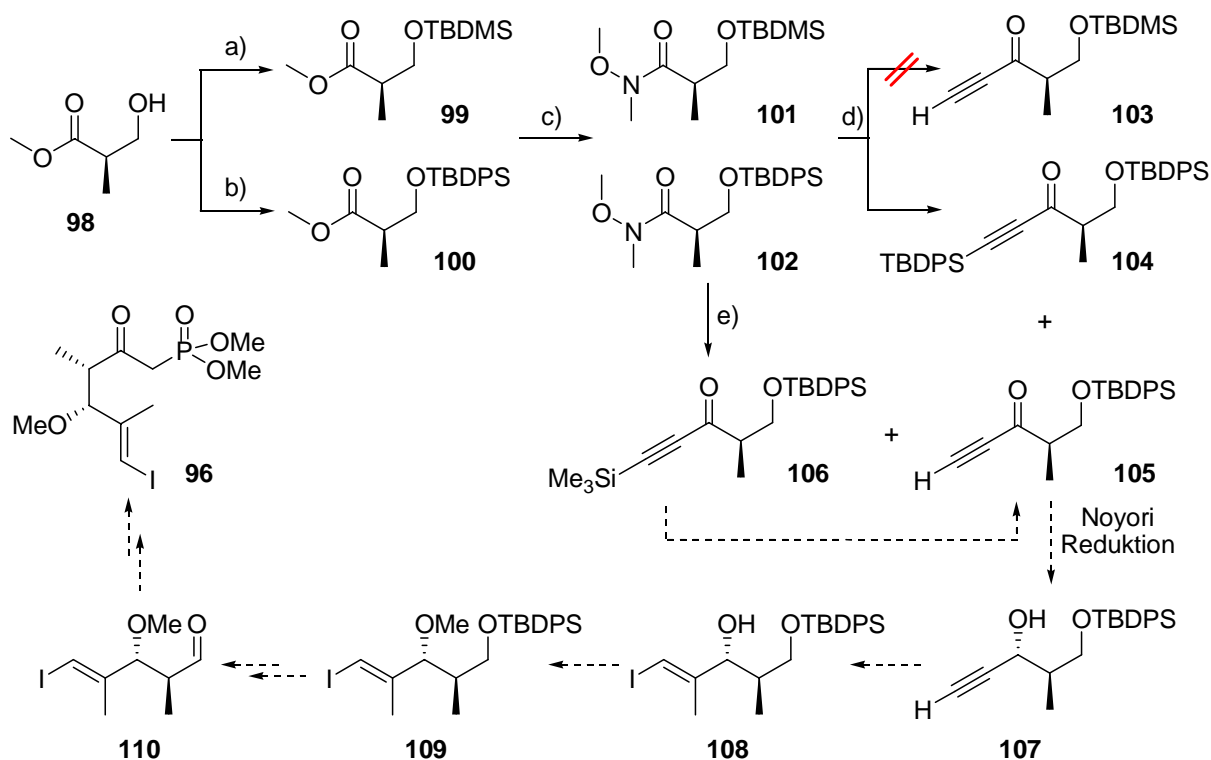


Scheme 26 Proposed catalytic cycle of *Evans anti* aldol reaction.

A proposed catalytic cycle³⁷ is outlined in Scheme 26. Presumably, *N*-acyloxazolidinone-magnesium complex **I** reacts with triethylamine, yielding magnesium enolate **II**, which then adds reversibly to the aldehyde, forming the magnesium aldolate **III**. Chlorotrimethylsilane then irreversibly traps the aldolate **III**, which was subsequently displaced from the metal centre by another molecule of *N*-acyloxazolidinone and produced the aldol product **97**.

3.4.2 Plan 2: *Noyori's Asymmetric Transfer Hydrogenation*

After the dissatisfaction with the results of zirconation-methylation-iodination of propargyl alcohol and the *Evans anti* aldol reaction, we made a second plan to construct the stereocentres at C16 and C17. The stereocentre at C17 could be configured with *Noyori's* asymmetric transfer hydrogenation of α -chiral alkynones.⁹⁴ The α -chiral alkynones could be prepared from (*R*)-methyl 3-hydroxy-2-methylpropanoate, which was widely used as chiral starting material in the total synthesis of natural products and their analogues.



Scheme 27 (a) TBDMSCl, imidazol, DMAP, THF, RT, 1.5 h, 89%; (b) TBDPSCl, imidazol, DCM, 0 °C to RT, 30 min, 98%; (c) MeONHMe·HCl, *i*PrMgCl, THF, -20 to -10 °C, 30 min, **101** = 90%, **102** = 93%; (d) lithium acetylide, ethylenediamine complex, THF, 0 °C to RT, 1 h, **105** = 26%, **104** = 10%; (e) trimethylsilylacetylene, *n*BuLi, THF, -78 °C to RT, 1 h, **106** = 39%, **105** = 20%.

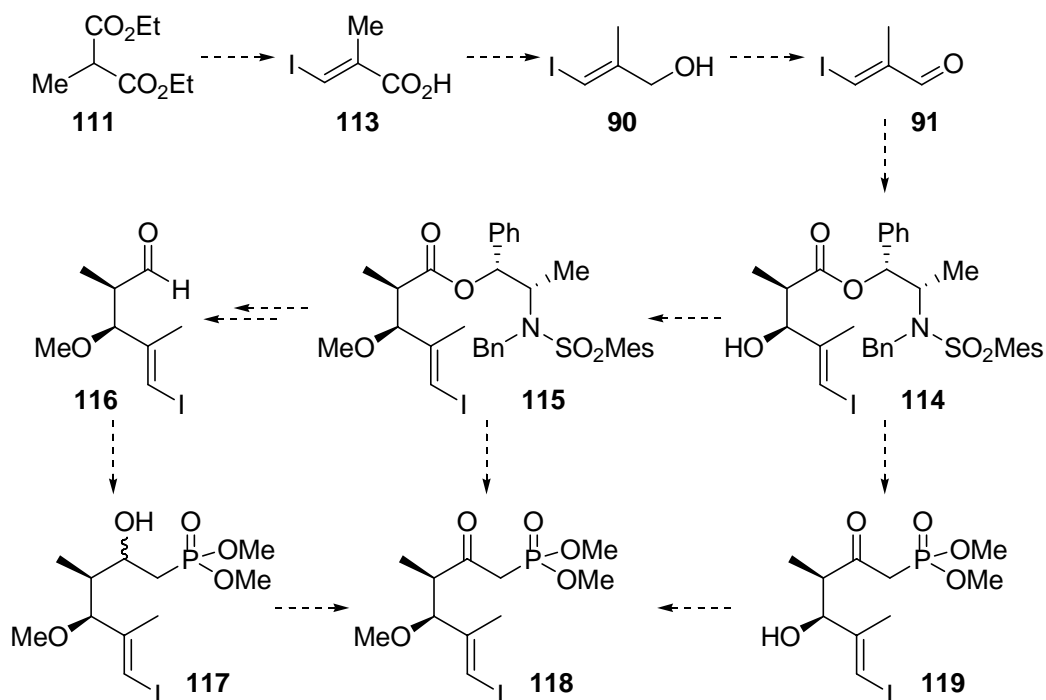
At first, (*R*)-methyl 3-hydroxy-2-methylpropanoate **98** was protected as its TBS⁹⁵ or TBDPS⁹⁶ ether **99/100** under standard conditions. Then, the ester **99/100** was converted to the *Weinreb* amide **101/102** with MeONHMe·HCl and *i*PrMgCl in THF in high yield.⁹⁷ Treatment of the *Weinreb* amide **102** with lithium acetylide ethylenediamine complex, followed by hydrolysis

of the crude product with water, afforded ynones **105** and **104** in 26% and 10% yield, respectively. The same reaction with the *Weinreb* amide **101** gave no desired ynone **103**. Addition of lithium trimethylsilylacetylide (freshly generated by using ethynyltrimethylsilane and *n*BuLi at $-78\text{ }^{\circ}\text{C}$) to *Weinreb* amide **102** provided ynone **106** in 39% yield and ynone **105** in 20% yield.⁹⁸

Due to these only moderate yields we turned our attention to an alternative strategy.

3.4.3 Plan 3: *Abiko-Masamune anti* Aldol Reaction

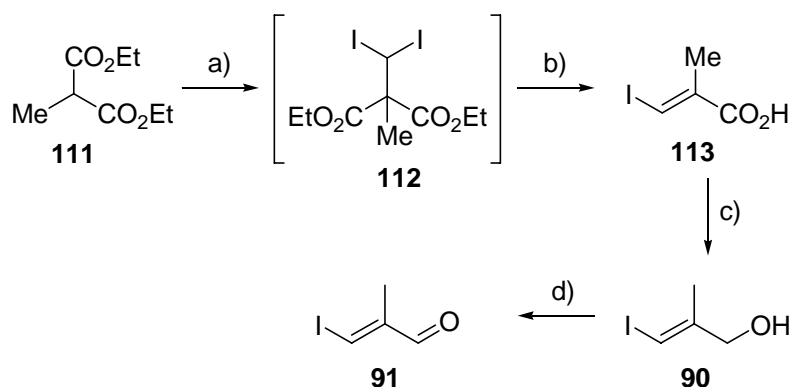
We then focused on an *anti*-selective asymmetric boron-mediated aldol reaction which was reported by *Abiko* and *Masamune*.³⁸ The aldol product could be converted to the phosphonate **118**, which would be then connected with the C3-C13 subunit **71** by a *Horner-Wadsworth-Emmons* (*HWE*) reaction. We considered three possibilities to prepare the phosphonate **118** from the aldol product **114**: (i) methylation of the hydroxyl group, reductive cleavage of the auxiliary, followed by oxidation of the resulting primary alcohol should give the aldehyde **116**, that could then be converted to the phosphonate **118** by using a modified *Wittig* reaction; (ii) alternatively, the methylated aldol product **115** could be directly converted to the phosphonate **118** or (iii) and the aldol product **114** would be directly transformed to the phosphonate **119**.



Scheme 28 Synthetic plan for the preparation of phosphonate **118**.

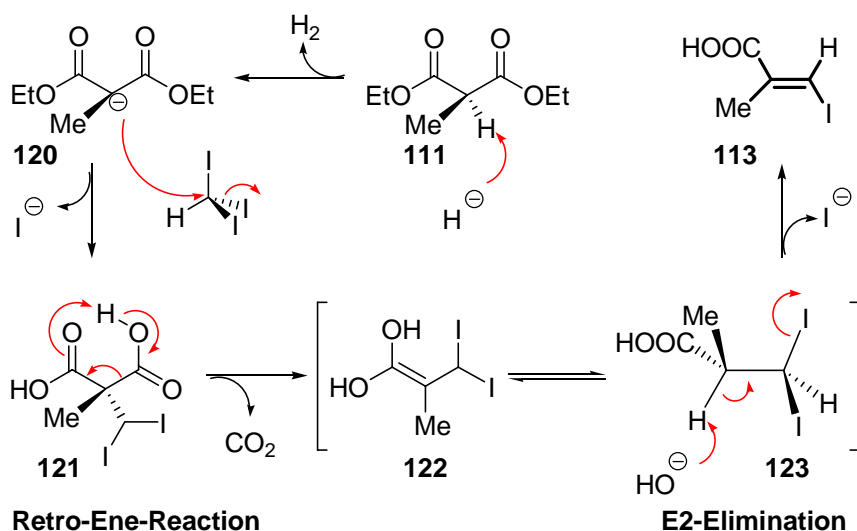
3.4.3.1 Synthesis of the Vinyl iodide

The synthesis of the C14-C19 subunit commenced with the preparation of the known aldehyde **91** from diethyl 2-methylmalonate **111** by a four-step reaction sequence reported by *Baker* and *Castro* in the course of their total synthesis of (+)-macbecin I.⁹⁹ In the course of this study, this original four-step reaction sequence was optimized. Treatment of diethyl 2-methylmalonate **111** with iodoform and sodium hydride in Et₂O at reflux gave the intermediate **112**, which after acidic workup and without further purification, was directly converted into the acid under basic conditions. This optimized procedure gave better yield and was amenable to the production of multigrams of acid **113**. Then, reduction of the acid **113** using lithium aluminum hydride, followed by oxidation of the resulting allylic alcohol **90** with manganese dioxide and 4Å molecular sieves (MS) at room temperature provided vinyl iodide **91** in quantitative yield, which was ready for *Abiko-Masamune anti* aldol reaction.



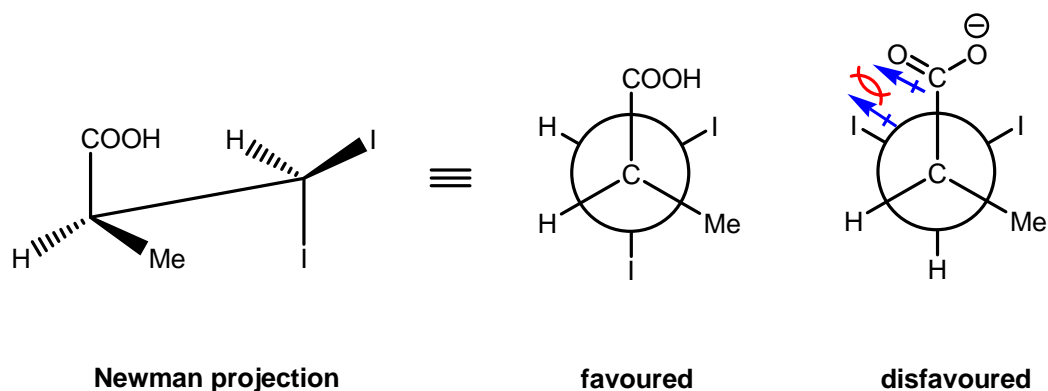
Scheme 29 (a) NaH, CHI₃, Et₂O, 50 °C, 32 h; (b) KOH, EtOH/H₂O (3:1), 100 °C, 24 h, 77% over two steps; (c) LiAlH₄, Et₂O, RT, 4 h, 90%; (d) MnO₂/4Å MS, DCM, RT, 1 h, quant.

To explain the very high *E*-selectivity of this transformation to acid **113**, we propose a mechanism as shown in Scheme 30. Accordingly, the steps should be (i) dehydrogenation of diethyl 2-methylmalonate **111** with the strong base NaH; (ii) addition of the resulting nucleophilic malonate ion **120** to iodoform; (iii) loss of CO₂ by a retro-ene-reaction and; (iv) removal of the proton with base and loss of iodide ion as leaving group.



Scheme 30 Proposed mechanism of the preparation of the acid **113**.

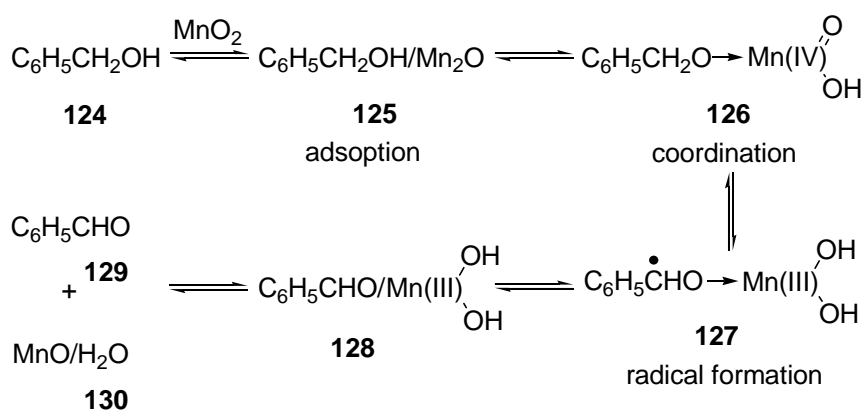
Following the E2-Elimination, a staggered conformation of the carboxyl and iodide should be favoured due to the electrostatic interaction of dipoles and stereochemical effects giving the desired product (Scheme 31).



Scheme 31 The electrostatic interaction of dipoles and the stereochemical effect.

A proposed radical mechanism for the oxidation of primary allylic alcohol by manganese dioxide was showed in scheme 32.¹⁰⁰ The suggested steps are (i) adsorption of aldehyde **124** on manganese dioxide to give **125**; (ii) formation of a coordinated complex **126**; (iii) transfer of a hydrogen atom to give the stable radical **127**, and (iv) intramolecular electron-transfer to give products **128-130**. During the course of this study, it was realized that this oxidation reaction proceeds more effectively with molecular sieves (fewer equivalents of manganese dioxide and shorter reaction time). There are two possible causes: (i) molecular sieves should

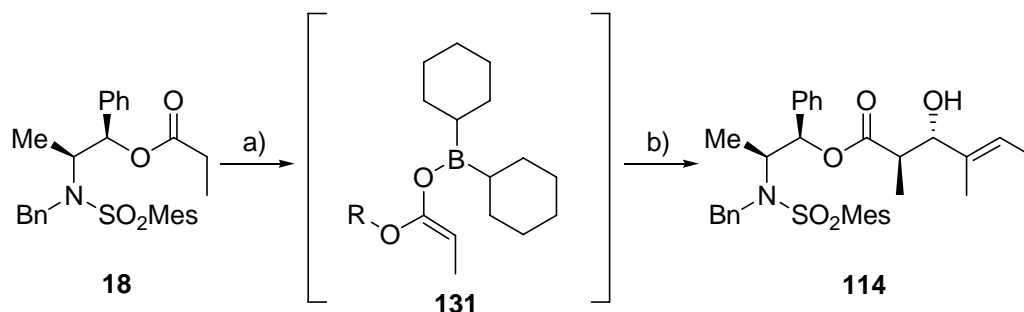
remove water from the reaction as it proceeds (ii) the stirring should be more effectively with molecular sieves because manganese dioxide is heavy and can not be mixed with only one magnetic stir bar. Therefore, the contact between solid and liquid phase may be optimized. This is agreement with previous results on the beneficial use of ultrasonic baths on this reaction.



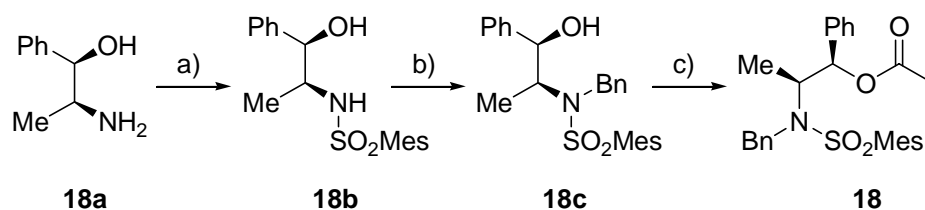
Scheme 32 A proposed radical mechanisms for the oxidation by manganese dioxide

3.4.3.2 *Abiko-Masamune anti Aldol Reaction*

Following the *Abiko-Masamune* protocol, enolization of propionate ester **18**, which was readily prepared from commercial norephedrine **18a** by selective sulfonylation, selective N-benylation and acylation reactions (Scheme 34), with $(cHex)_2BOTf$ and Et_3N at $-78\text{ }^\circ\text{C}$ gave the intermediate *E*-enolate **131**, that reacted with the aldehyde **91** to provide the *anti* aldol adduct **114** in high selectivity (d.r. > 20:1) and excellent yield (96%) (Scheme 33).¹⁰¹



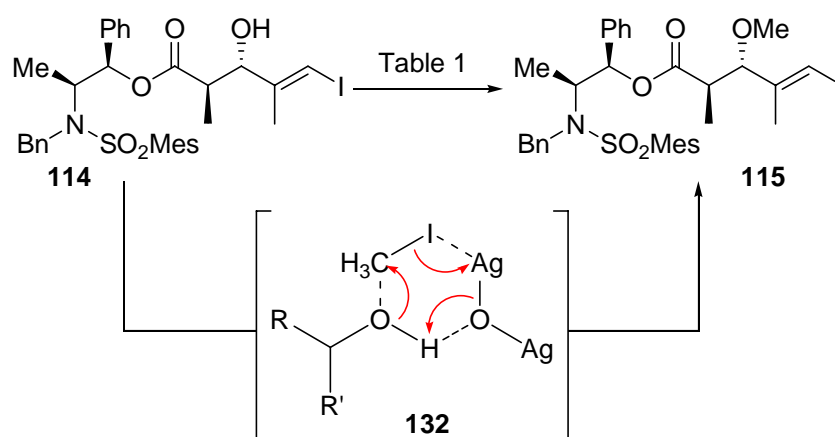
Scheme 33 (a) $(cHex)_2BOTf$, Et_3N , DCM, $-78\text{ }^\circ\text{C}$, 2 h; (b) aldehyde **91**, $-78\text{ }^\circ\text{C}$, 3 h, 96%, (d.r. > 20:1).



Scheme 34 (a) MesSO₂Cl, Et₃N, DCM, 0 °C, 2 h, 100%; (b) BnBr, *t*BuOK, DMF, RT, 3 h, 95%; (c) EtCOCl, pyridine, DCM, 0 °C to RT, 15 h, 100%.

3.4.3.3 *O*-Methylation of the Aldol Adduct

Three methods were evaluated to convert the aldol product **114** into methyl ether **115**, as shown in Table 1: methylation with *Meerwein's* salt and proton sponge^{®102} provided the required methyl ether **115** in 71% yield; treatment with methyl triflate and 2,6-di-*tert*-butylpyridine¹⁰³ as base afforded the product **115** in 78% yield. Best results were obtained by using methyl iodide, silver(I) oxide¹⁰⁴ and molecular sieves. The product may be readily isolated without silica gel chromatography, only by filtration. The proposed intermediate **132** of this methylation using methyl iodide and silver(I) oxide is shown in scheme 35. During the course of this study, it was realized that this methylation reaction proceeds more effectively with molecular sieves (fewer equivalents of silver(I) oxide and shorter reaction time). In analogy to MnO₂/MS discussed above, there are two possible causes: (i) molecular sieves should remove water from the reaction as it proceeds; (ii) the stirring should be more effectively with molecular sieves because silver (I) oxide is heavy and can not be mixed with only one magnetic stir bar. Therefore, the contact between solid and liquid phase may be optimized.

Scheme 35 *O*-Methylation of the aldol adduct and proposed transition state.

Methylation Reagent	Base	Solvent	T (°C)	Time (h)	Yield (%)
		DCM	0	24	71
		DCM	RT	72	78
	Ag ₂ O/4 Å MS	Et ₂ O	RT	48	91

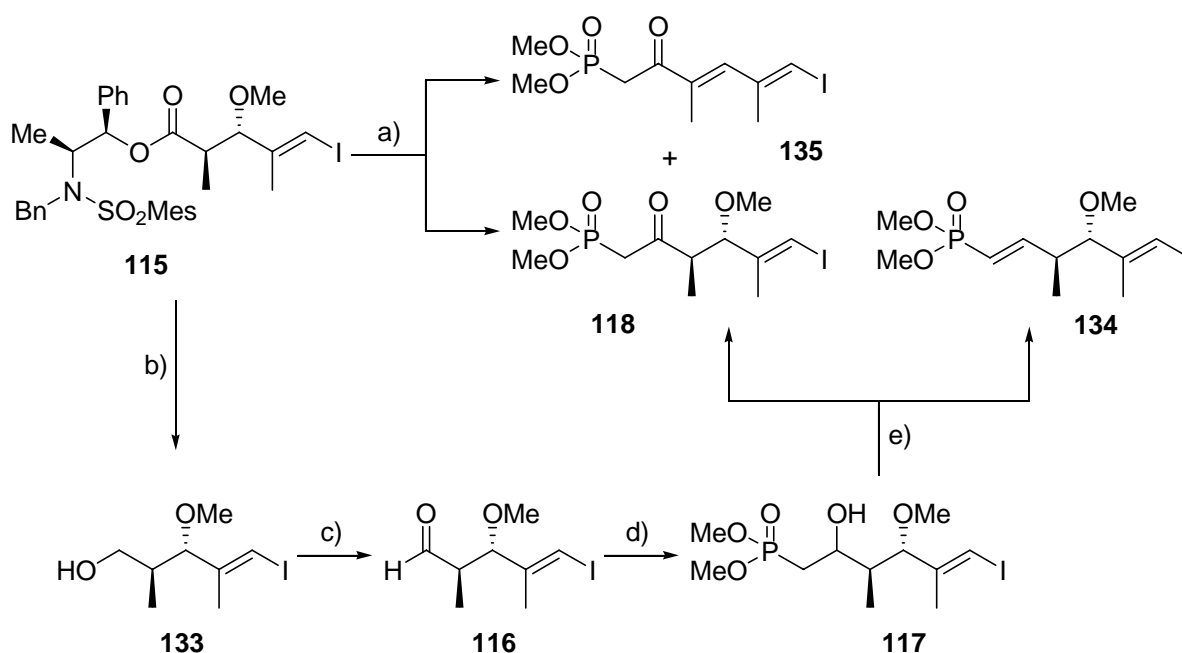
Table 1 *O*-methylation of the aldol adduct **114** by use of different methods.

3.4.3.4 The Phosphonate Fragment

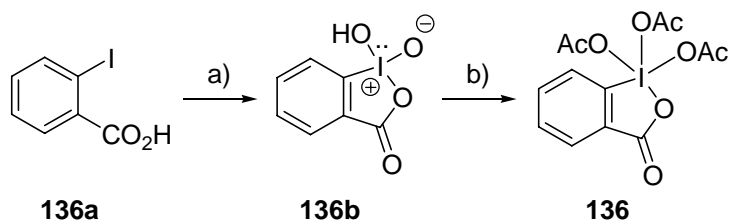
Subsequently, the conversion of the methyl ether **115** to phosphonate **118** was studied. Initial attempts for a direct conversion, however, were not successful. The phosphonate **118** was isolated only in 9% yield, giving mainly the elimination product **135** in 38% yield. We then had to resort to a 4 steps sequence. LiAlH₄ reduction of the ester, followed by *Dess-Martin* oxidation of the resulting primary alcohol **133** gave the aldehyde **116**. Addition of lithiated dimethyl methylphosphonate to the resulting aldehyde **116**, followed by *Dess-Martin*

oxidation of the resulting secondary alcohol **117** afforded phosphonate **118** in satisfactory yield.

To our surprise, if excess of *Dess-Martin* periodinane was used in the reaction, again substantial amounts of elimination were observed to give phosphonate **134**. This may be due to the water and slightly acidic conditions, originating from the preparation of *Dess-Martin* periodinane **136** (Scheme 37),¹⁰⁵ as acetic acid may not be completely removed from the reagent.

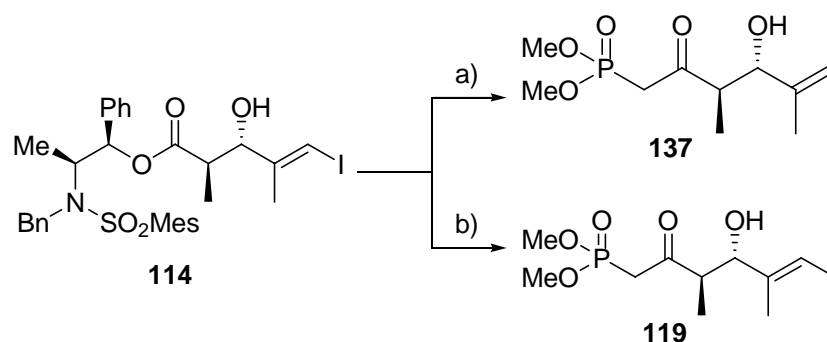


Scheme 36 (a) *n*BuLi, dimethyl methylphosphonate, THF, -20 °C, **118** = 9%, **135** = 38%; (b) LiAlH₄, Et₂O, 0 °C, 1.5 h, 97%; (c) DMP, DCM, 0 °C, 2 h; (d) *n*BuLi, dimethyl methylphosphonate, THF, -78 to 0 °C, 3 h; (e) DMP, DCM, RT, **118** = 46% over 3 steps, **134** = 45% over 3 steps.



Scheme 37 (a) Oxone[®], H₂O, 70 °C, 3 h; (b) Ac₂O, *p*TsOH · H₂O, 80 °C, 2 h.

Directly, as shown in Scheme 36, the methyl ether **115** underwent elimination of MeOH to the phosphonate **135**. At this point it seemed desirable to avoid this type of elimination and to study the direct conversion of *Abiko-Masamune anti* aldol products to other functionalities like β -ketone phosphonate **119**, which may be used for *Horner-Wadsworth-Emmons* reaction.¹⁰⁶ With this consideration, the reactions between the aldol adduct **114** and dimethyl methylphosphonate were carried out by employing *i*PrMgCl and *n*BuLi as base. The deiodinated product **137** was achieved instead of the desired product **119**. This could be explained with the iodine/metal exchange mechanism.¹⁰⁷ But using KHMDS as base to dehydrogenize dimethyl methylphosphonate, the desired phosphonate **119** was obtained in good yield.



Scheme 38 (a) *i*PrMgCl then $\text{CH}_3\text{P}(\text{O})(\text{OCH}_3)_2$, *n*BuLi, THF, -78 °C to RT, 15 h, 86%. (b) *i*PrMgCl then $\text{CH}_3\text{P}(\text{O})(\text{OCH}_3)_2$, KHMDS, THF, -78 °C to -20 °C, 2 h, 80%;

This conversion could be understood with the transition state **138** (Figure 17). *i*PrMgCl coordinates the aldol adduct **114**. The resulting Mg^{2+} then acts as protecting group for the hydroxyl¹⁰⁸ and activates the carbonyl by chelation.

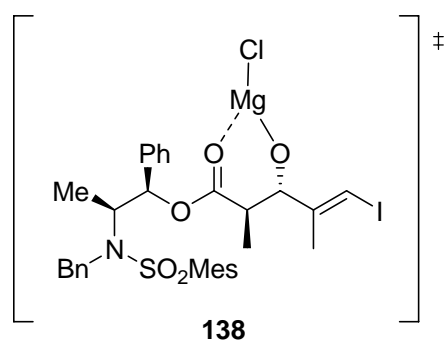
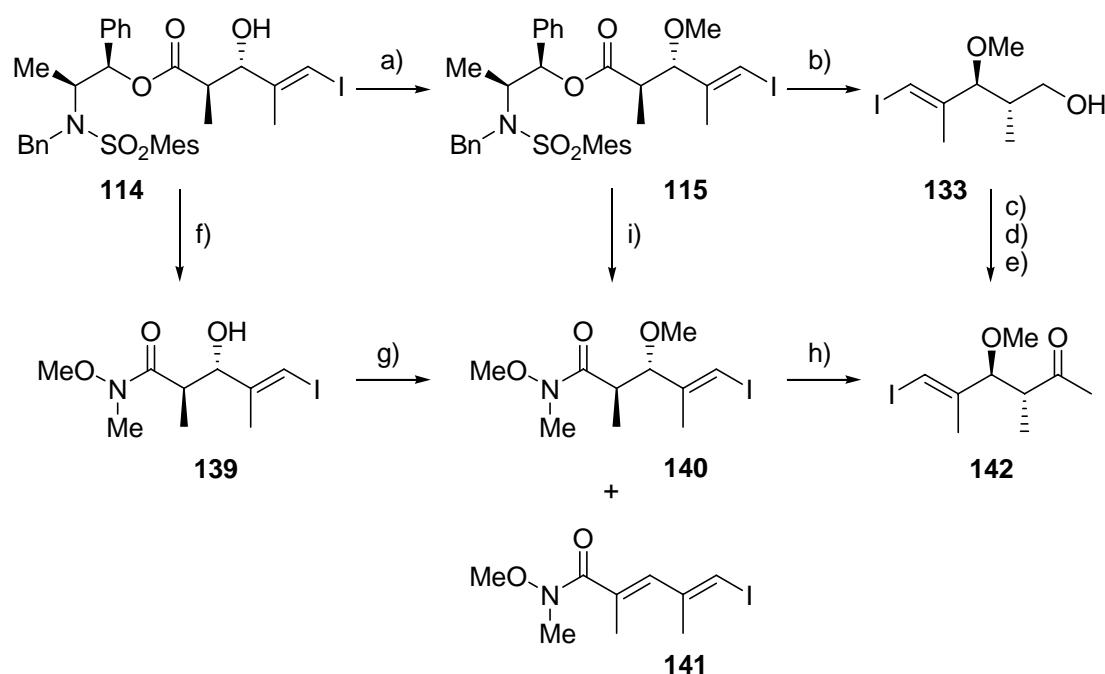


Figure 17 Proposed transition state of activation of β -hydroxy ester with *i*PrMgCl.

3.4.3.5 The Methyl Ketone Fragment

Synthesis of methyl ketone **142** began with the *O*-methylation of the *Abiko-Masamune anti* aldol product **114** with MeI, Ag₂O and 4Å molecular sieves in Et₂O to give the methyl ether **115** in 91% yield, as discussed above. The conversion of the ester **115** with *O,N*-dimethylhydroxylamine hydrochloride and *i*PrMgCl to give *Weinreb* amide **140** was not satisfactory.¹⁰⁹ Two products **140** and **141** were obtained at the ratio of three to one. Then, we used again a 4 steps sequence, i.e. reductive cleavage of the auxiliary, *Dess-Martin* oxidation of the resulting primary alcohol, methylation of the aldehyde with MeMgBr, and *Dess-Martin* oxidation of the secondary alcohol to give the desired methyl ketone **142** in 88% yield over four steps.



Scheme 39 (a) MeI, Ag₂O, 4Å Molecular Sieves, Et₂O, RT, 48 h, 91%; (b) LiAlH₄, Et₂O, 0 °C, 2 h, 97%; (c) DMP, NaHCO₃, DCM, RT, 4 h; (d) MeMgBr, THF, -78 °C, 30 min; (e) DMP, NaHCO₃, DCM, RT, 1.5 h, 92% over 3 steps. (f) *O,N*-dimethylhydroxylamine hydrochloride, *i*PrMgCl, THF, -20 °C to -10 °C, 3 h, 72%; (g) MeI, Ag₂O, 4Å MS, Et₂O, RT, 72 h, 85%; (h) MeMgBr, THF, -20 °C to RT, 1 h, 93%. (i) *O,N*-dimethylhydroxylamine hydrochloride, *i*PrMgCl, THF, -20 °C to RT, 4 h, 22%, **140** : **141** = 3:1.

Although this approach is effective (5 steps, 80%), we wanted to shorten the synthetic steps of the methyl ketone **142** and study the direct displacement of the auxiliary by *Weinreb* amide

nucleophile, which might then allow direct extension of the aldol adduct using a *Grignard* reaction.¹¹⁰ However, direct conversion of aldol product **114** with *O,N*-dimethyl hydroxylamine hydrochloride and *iPrMgCl* to the corresponding *Weinreb* amide **139** was again successful. In analogy to the mechanism discussed above, this reaction is expected to proceed *via* the intermediate **138** as shown in Figure 17. Again, chelation of Mg to the carbonyl oxygen might activate the ester functionality. Thereby, the carbonyl carbon becomes more electrophilic. If Me_3Al ,¹¹¹ Me_2AlCl ,¹¹² DIBAL-H,¹¹³ *nBuLi*¹¹⁴ were used instead of *iPrMgCl*, no desired product was achieved. Then methylation of the free hydroxyl group, followed by transformation of *Weinreb* amide with MeMgBr gave the desired methyl ketone **142** in 80% over 2 steps.

3.4.3.6 Conclusion

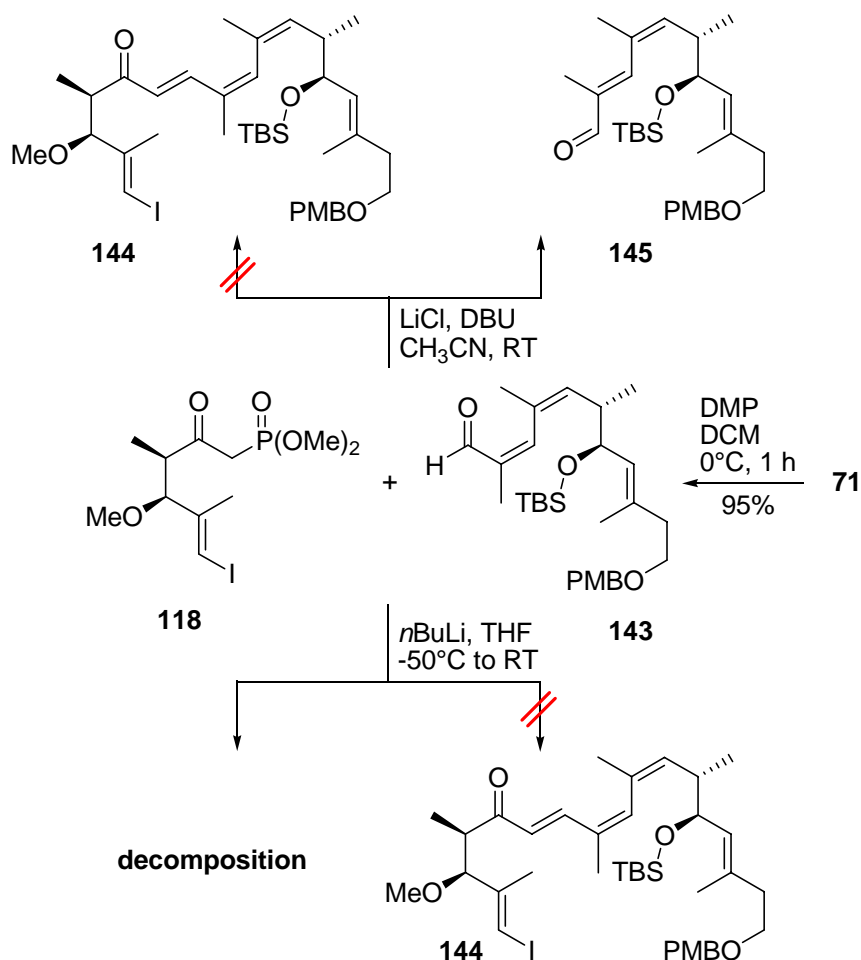
During the synthesis of the C14-C19 subunit, three strategies, namely *Evans anti* aldol, *Noyori's* asymmetric transfer hydrogenation and *Abiko-Masamune anti* aldol were evaluated to install the stereocentres at C16 and C17. Most efficiently, the two stereocentres were constructed by employing *Abiko-Masamune anti* aldol reaction. The preparation procedure of the acid **113** was optimized and amenable to produce multigrams. Also a study of the direct displacement of the *Abiko-Masamune* auxiliary by phosphonate and *Weinreb* amide nucleophiles was successful using *iPrMgCl* for carbonyl activation. In total, subunit **142** was obtained in 10 steps with 54% overall yield in a well-scalable synthesis providing several grams of the required building block.

3.5 Connection of the C3-C13 and the C14-C19 Subunits

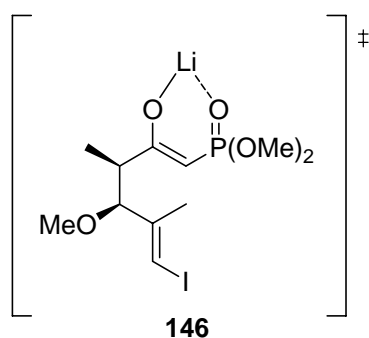
3.5.1 HWE-Reactions between Phosphonate **118** and Aldehyde **143**

With phosphonate **118** in hand, *HWE* reactions with aldehyde **143** were carried out. At first, we selected the mild condition according to the *Masamune-Roush* protocol (LiCl, DBU, CH₃CN, RT). In the presence of lithium chloride, the phosphonates **118** could be easily deprotonated with an amine, e.g. DBU or DIPEA, to generate reactive species under these simple, mild conditions. Here, Li⁺ most likely forms a tight complex **146** with the carbanion derived from phosphonate **118** as shown in Figure 18, thereby enhancing the acidity of phosphonate **118**.¹¹⁵

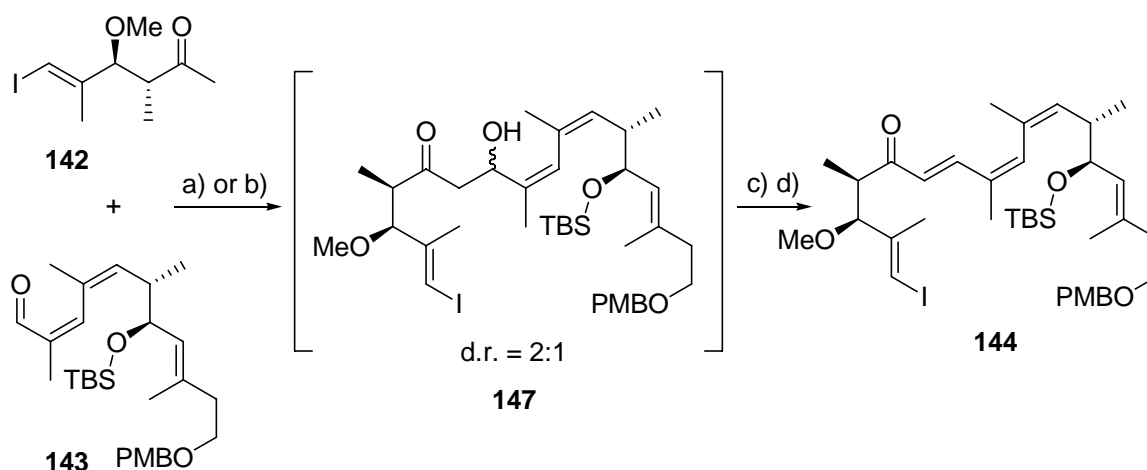
However, even under these mild conditions, no desired product was observed, and the aldehyde was isomerized. Stronger bases, for instance *n*BuLi, led to extensive decomposition. We therefore had to focus on an alternative strategy, an aldol disconnection.



Scheme 40 Unsuccessful *HWE* reactions between phosphonate **118** and aldehyde **143**.

Figure 18 Li-activation of the β -ketone phosphonate.

3.5.2 Aldol Condensation between Methyl Ketone and Aldehyde



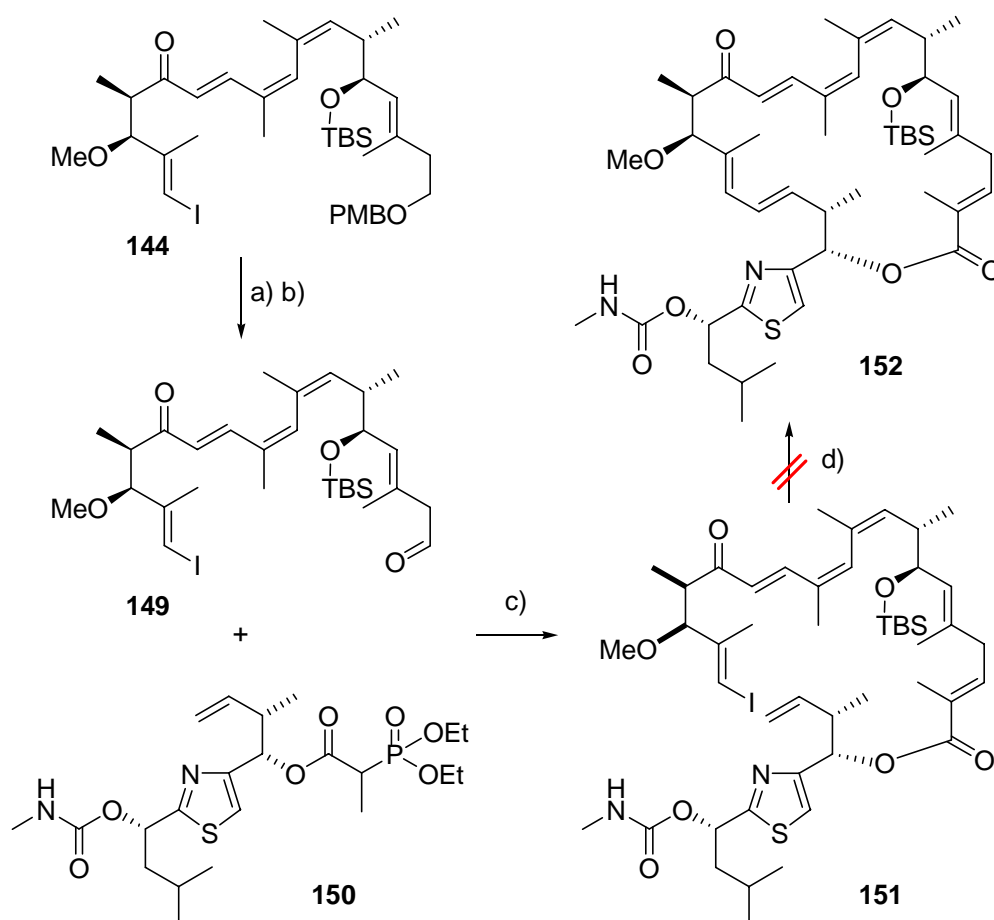
Scheme 41 (a) $(cHex)_2BCl$, Et_2O , $-78\text{ }^\circ C$, 1.5 h, 95%; (b) LiHMDS, THF, $-78\text{ }^\circ C$, 1 h, 74%; (c) Ac_2O , DMAP, THF, $0\text{ }^\circ C$ then RT; 40 min; (d) DBU, THF, RT, 1 h, 93% over 2 steps.

Accordingly, lithium and boron mediated aldol reactions were tried to assemble methyl ketone **142** and aldehyde **143**. The boron mediated aldol reaction gave the better results and the respective aldol products **147** were obtained in 95% yield. Acylation of the free OH-group with Ac_2O and DMAP, followed by elimination with DBU provided the product **144** in 93% yield. Therefore, the two northern fragments were successfully connected by using an aldol condensation reaction.

The next step was the attachment of the thiazol fragment **83** to **144**.

3.6 Connection of the C3-C19 and the C20-C1'' Subunits

Deprotection of the PMB-group with DDQ and pH7-buffer in DCM, followed oxidation of the resulting primary alcohol under *Swern* conditions provided the aldehyde **149** in excellent yield. The intermolecular *HWE* reaction between aldehyde **149** and phosphonate **150**¹¹⁶ with NaH as base led to the desired product **151**, albeit in only poor yield (20%). Under *Masamune-Roush* conditions (LiCl, DBU, CH₃CN, RT), the aldehyde **149** was isomerised and no desired product was isolated. With stronger base such as KHMDS, complete decomposition of the starting materials was observed. The *Heck*-Macrocyclisation reaction with PdCl₂(PPh₃)₂, K₂CO₃ and *n*BuNCl at 80 °C gave no desired cyclisation product **152** and led to decomposition.

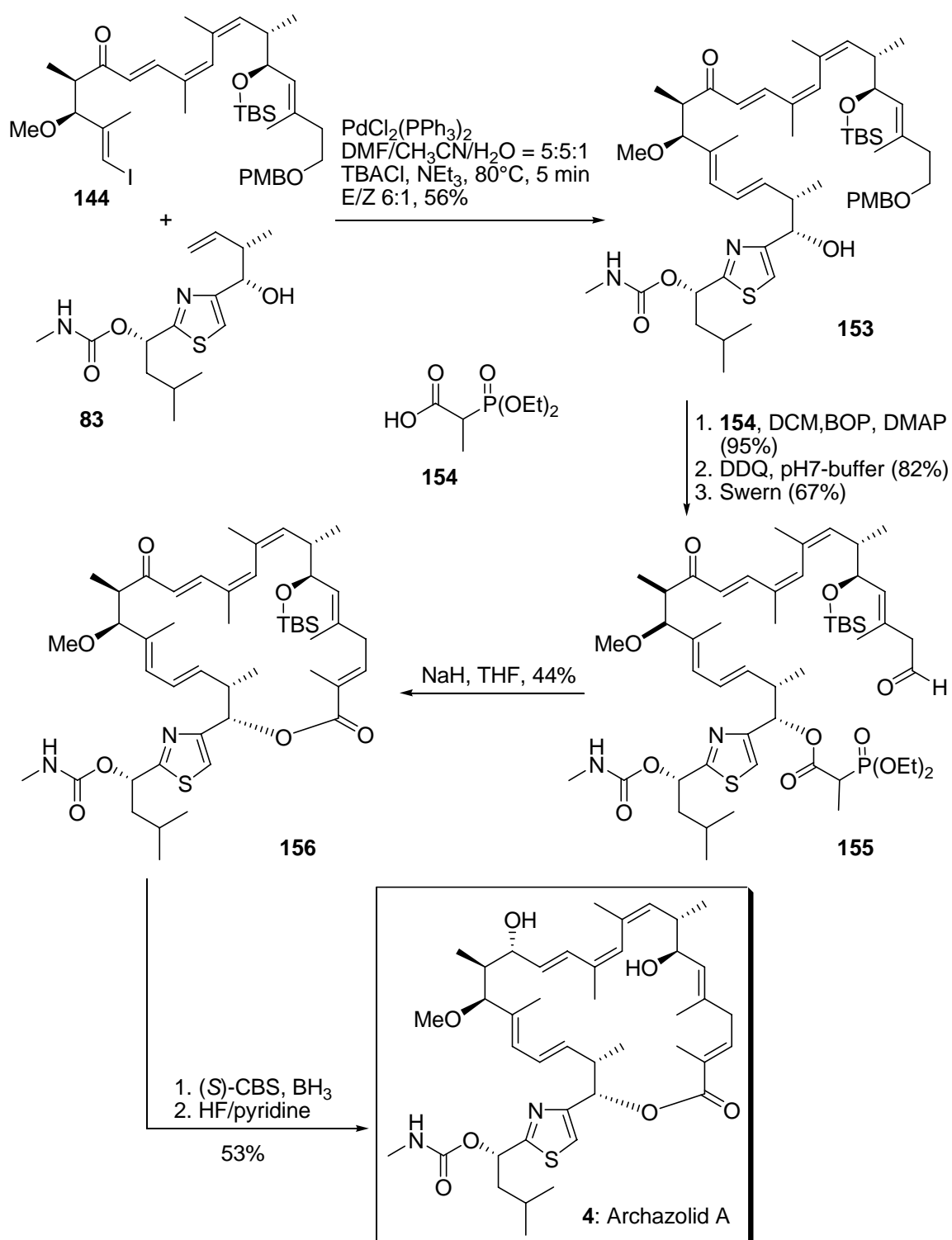


Scheme 42 (a) DDQ, pH7-buffer, DCM, RT, 30 min, **148** in 94%; (b) oxalyl chloride, DMSO, Et₃N, 4 Å MS, -78 °C, 1 h, 94%; (c) NaH, THF, RT, 5 h, 20%; (d) PdCl₂(PPh₃)₂, K₂CO₃, *n*Bu₄NCl, 80 °C, 1 h.

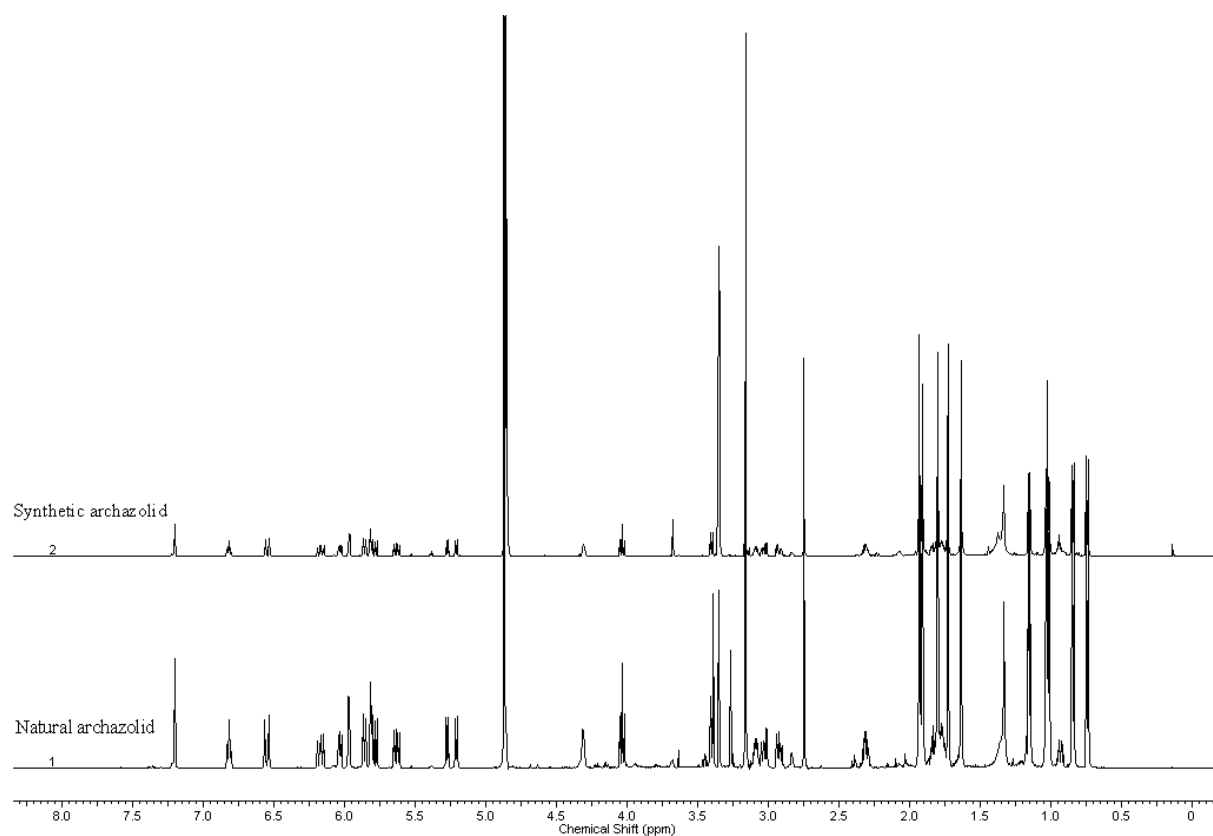
3.7 Completion of the First Total Synthesis

trans-Selective Heck Reaction and the HWE-Macrocyclisation – Sven Rudolph

Therefore, the order of these reactions was changed. This sequence was pursued by *Sven Rudolph* in our group. Using more conventional protocols,¹¹⁷ the *inter*-molecular Heck reaction between the iodide **148** and the terminal alkene **83** provided poor *E/Z*-selectivity and yield. Therefore, conditions for this coupling reaction were optimized. Finally, ideal conditions include PdCl₂(PPh₃)₂ as catalyst, DMF, acetonitrile and water as solvents to give the desired product in good yield and very good selectivity. After esterification of the Heck-product, followed by PMB deprotection and *Swern* oxidation provided the aldehyde **155**, which was ready for the HWE-macrocyclisation. This was successfully carried out by use of NaH as base. Asymmetric reduction of the ketone function to alcohol with (*S*)-CBS and BH₃, followed by desilylation with HF/pyridine provided archazolid A (**4**) (Scheme 43).

Scheme 43 Completion of the first total synthesis of archazolid A (**4**).

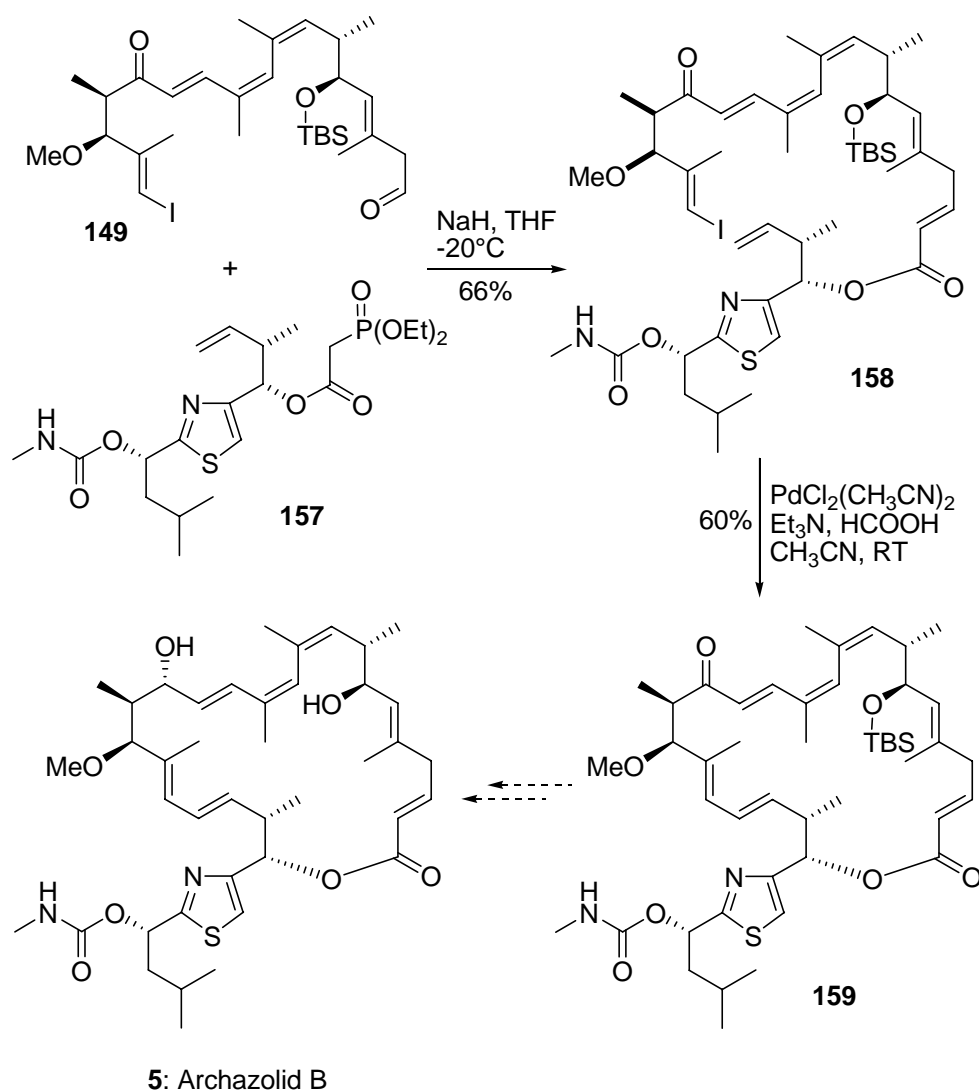
The spectroscopic data (^1H NMR, ^{13}C NMR, MS) and specific rotation ($[\alpha]_{\text{D}} = -47^\circ$ ($c = 1.2$ mg/mL, MeOH)) of our synthetic material were in agreement with those of an authentic sample obtained from the *Archangium gephyra* myxobacterial source (Scheme 44).



Scheme 44 ^1H NMR spectra comparing synthetic and natural Archazolid A (**4**).

3.8 Heck-Macrocyclisation: Towards Archazolid B

After the total synthesis of archazolid A (**4**), we tried to synthesize archazolid B (**5**) by use of Heck-macrocyclisation strategy. At first, the intermolecular *HWE* reaction between the aldehyde **149** and phosphonate **157**¹¹⁸ was carried out using NaH as base. The Heck-macrocyclisation with PdCl₂(CH₃CN)₂/Et₃N/HCOOH as catalytic system¹¹⁹ provided the macrocycle **159** in good yield.¹²⁰ Final steps would involve our previously established protocols by the total synthesis of archazolid A (**4**).



Scheme 45 Towards the synthesis of archazolid B (**5**).

3.9 Conclusion

An expedient first total synthesis of archazolid A could be accomplished. It proceeds in 20 steps and 4% overall yield from **60** (longest linear sequence) and establishes unequivocally the relative and absolute configuration.¹²¹ Key transformations include highly enantio- and diastereoselective *Abiko-Masamune* and *Paterson anti*-aldol reactions and a crotylboration on an advanced intermediate to install the vicinal stereogenic centers at C7/C8, C15/C16 and C22/23 together with two highly *Z*-selective *Still-Gennari*-type *HWE* coupling to generate the 9*Z*,11*Z* alkenes. Coupling of the three fragments was effectuated by an efficient aldol condensation reaction, a highly advantageous *Heck*-coupling and subsequent *HWE*-macrocyclisation to construct the macroclactone. Importantly, this modular, convergent synthesis should be amenable to designed analogues of this novel V-ATPase inhibitor, enabling extensive exploration of its biological potential.

4 Studies Towards the Total Synthesis of Etnangien

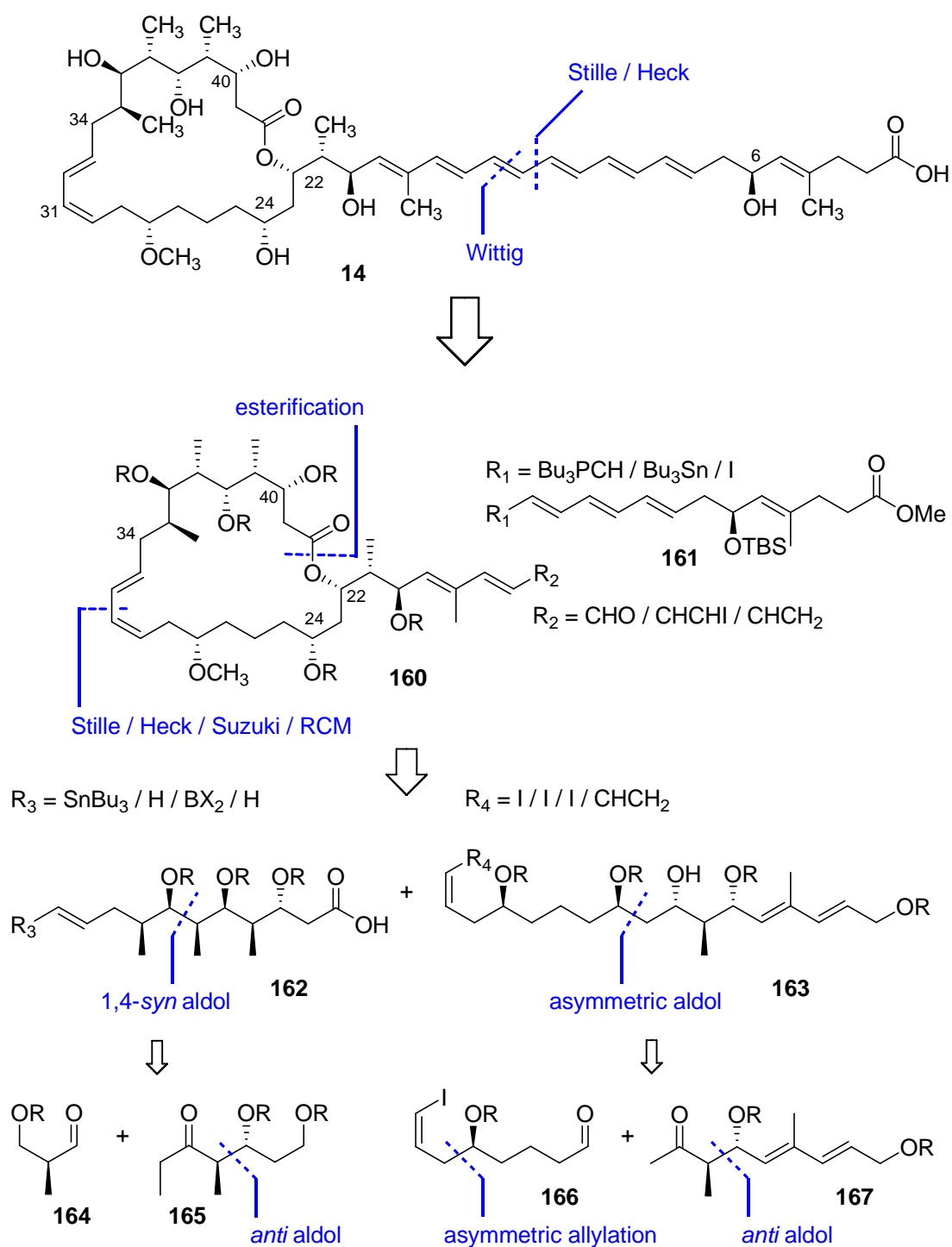
4.1 Retrosynthetic Analysis

As outlined retrosynthetically in Scheme 46, our synthetic approach relies on a late-stage coupling between macrocycle **160** and side chain **161** using a *Wittig* ($R_1 = \text{Bu}_3\text{PCH}$, $R_2 = \text{CHO}$), *Stille* ($R_1 = \text{Bu}_3\text{Sn}$, $R_2 = \text{CHCHI}$) or *Heck* reactions ($R_1 = \text{I}$, $R_2 = \text{CHCH}_2$). This retrosynthetic strategy calls for a late-stage introduction of the labile side chain. Notably, it allows for diversification to access various side chains to provide a range of structural derivatives to initiate structure-activity relationship studies.

The core structure **160** would be constructed by using inter- or intra-molecular metal mediated coupling reactions like *Stille* ($R_3 = \text{Bu}_3\text{Sn}$, $R_4 = \text{I}$), *Heck* ($R_3 = \text{H}$, $R_4 = \text{I}$), *Suzuki* ($R_3 = \text{BX}_2$, $R_4 = \text{I}$) reactions and esterification or macrolactonation such as *Yamaguchi* (2,4,6-trichlorobenzoyl chloride, DMAP, Et_3N), *Keck-Boden* (DCC, DMAP), *Mitsunobu* (DEAD, Ph_3P , Et_3N) or *Mukaiyama* (2-chloro-1-methylpyridinium iodide) between two fragments **162** and **163**. As alternative strategies, ring closing metathesis (RCM, $R_3 = \text{H}$, $R_4 = \text{CHCH}_2$) or relay ring closing metathesis (RRCM) could be employed for closing the macrocycle **160**.

In turn, the C34-C42 subunit **162** was planned to be accessible by a tin-mediated (1,4)-*syn* aldol reaction between aldehyde **164** and ethyl ketone **165**, which should be prepared using an auxiliary-controlled diastereoselective aldol reaction. The C15-C31 fragment **163** was envisioned to be derived by boron-mediated asymmetric aldol reaction between the C15-C23 subunit **167** and the C24-C31 subunit **166**. The stereocentre in the C24-C31 subunit **166** should be constructed by employing asymmetric allylation reaction. Using an auxiliary-controlled diastereoselective aldol reaction, the two stereocentres in the C15-C23 subunit **167** should be installed.

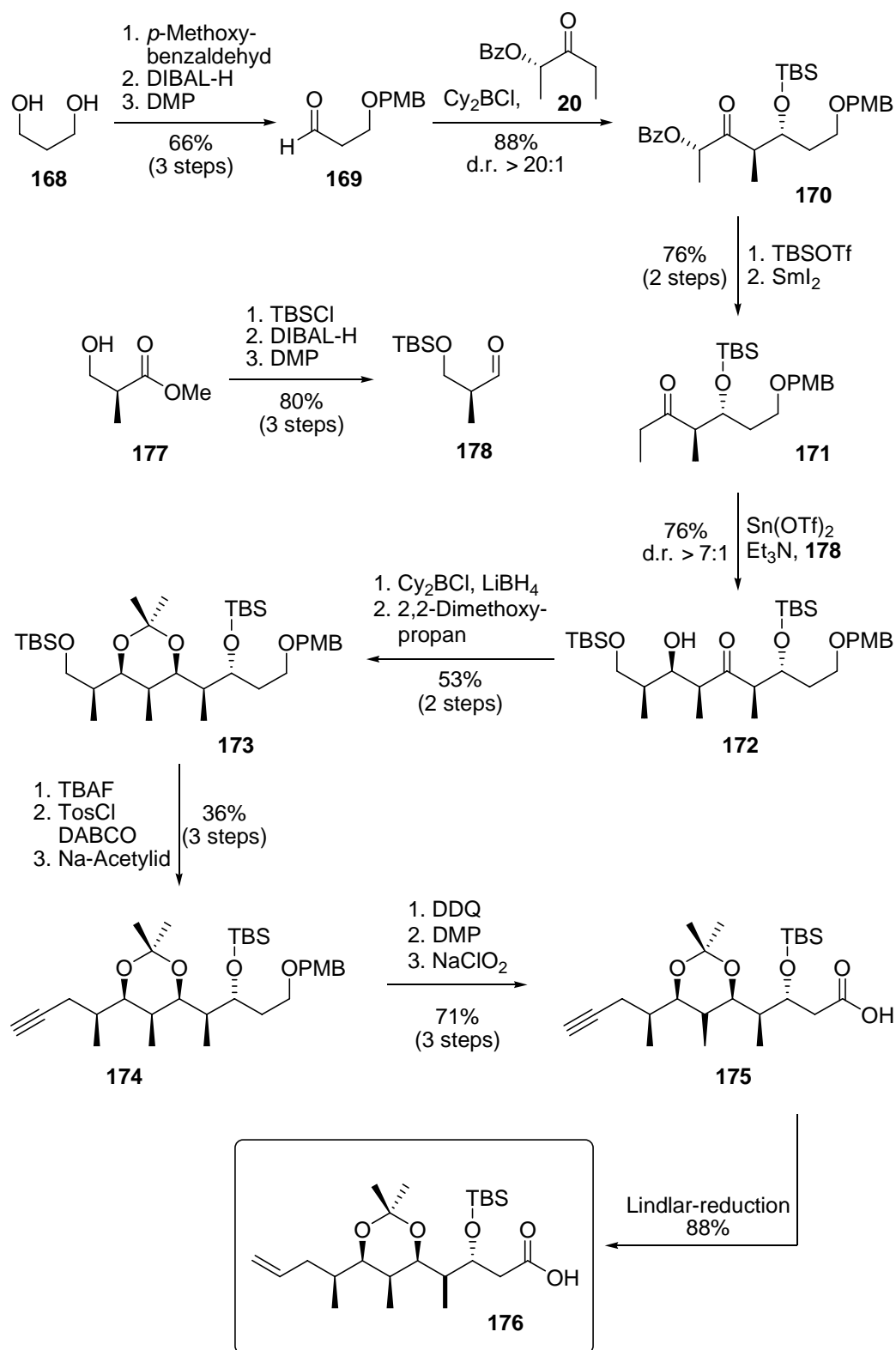
In summary, the devised route would allow assembly of etnangien in a flexible, highly convergent and stereocontrolled manner. Key issues to be addressed include (i) two auxiliary-controlled diastereoselective aldol reactions; (ii) a boron-mediated asymmetric aldol reaction; (iii) a tin-mediated (1,4)-*syn* aldol reaction; (iv) an asymmetric allylation reaction; (v) inter- or intra-molecular metal mediated coupling reactions; and (vi) esterification or macrolactonation.



Scheme 46 Retrosynthetic analysis of etnangien.

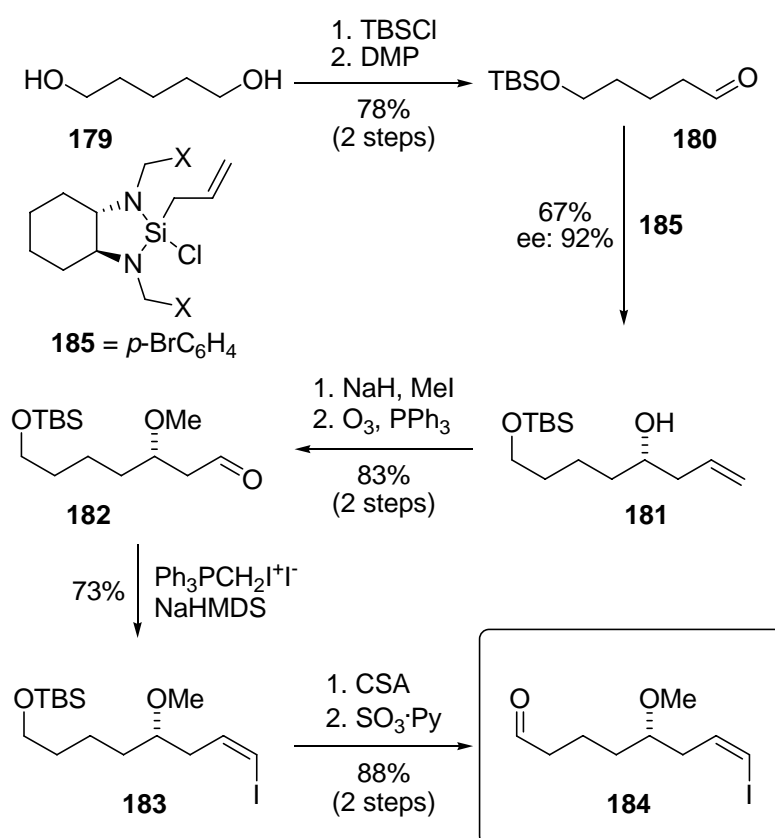
4.2 Synthesis of the C34-C42 Subunit – *Fatih Arikan*

The synthesis of the C34-C42 subunit **176** was realised by *Fatih Arikan* in our group. As shown in Scheme 47, it began with the preparation of PMB-protected aldehyde **169** in three steps fashion, PMP-acetal formation, DIBAL-H reduction and DMP oxidation. A dicyclohexylboron mediated *Paterson anti*-aldol reaction of lactate-derived ethyl ketone **20** with the PMB-protected aldehyde **169** proceeded with excellent diastereoselectivity and yield (d.r. > 20:1, 88%). Reductive removal of the α -benzoate substituent in **170** by SmI_2 gave the corresponding ethyl ketone **171**. Then, the tin-mediated (1,2)- and (1,4)-*syn* aldol reaction of ethyl ketone **171** with *Roche*-ester **177** derived aldehyde **178** (TBS protection, DIBAL-H reduction and DMP oxidation) proceeded with useful selectivity (d.r. > 7:1) and yield (74%).¹²² The resulting β -hydroxy ketone **172** then underwent a 1,3-*syn*-selective reduction when treated with $(c\text{Hex})_2\text{BCl}$ and LiBH_4 generating the respective diol (d.r. > 20:1),¹²³ which was then protected as the cyclic acetal **173**. After selective primary TBS cleavage with TBAF, tosylation with TosCl and DABCO¹²⁴ and triple bond formation with Na-acetylide, the resulting compound **174** was converted to acid **175** in three steps, DDQ deprotection, DMP oxidation and *Pinnick* oxidation.¹²⁵ The C34-C42 subunit **176** was obtained after reduction of the triple bond in **175** using Lidlar-catalyst. In total, the desired C34-C42 fragment was obtained in a highly convergent and stereoselective route. This fragment was available in 16 steps in 4% yield. Likewise, this route was well-scalable and allowed to obtain multi-gram quantities of the C34-C42 subunit **176**.

Scheme 47 The synthesis of the C34-C42 subunit **176**.

4.3 Synthesis of the C24-C31 Subunit – Pengfei Li

The preparation of the C24-C31 subunit **184**, as realised by *Pengfei Li* in our group is shown in Scheme 48. It starts with selective TBS protection of diol **179**, followed by DMP oxidation of primary alcohol to provide aldehyde **180**, which underwent a silicium-based asymmetric allylation reaction¹²⁶ to allylic alcohol **181** in high selectivity and good yield. Methylation of the allylic alcohol **181** with MeI and NaH as base, followed by ozonolysis¹²⁷ with O₃ and PPh₃ afforded aldehyde **182**, which was converted to iodide **183** by use of a *Stork-Zhao-Wittig* olefination reaction.¹²⁸ Finally, the synthesis of the C24-C31 subunit **184** was completed in two steps involving TBS cleavage with CSA and oxidation of the resulting primary alcohol with *Parikh-Doering* Oxidation.¹²⁹ In summary, this route to the C24-C31 subunit **184** proved likewise well-scalable and multigram quantities of required building block were obtained from **179** in 8 steps and 30% overall yield.

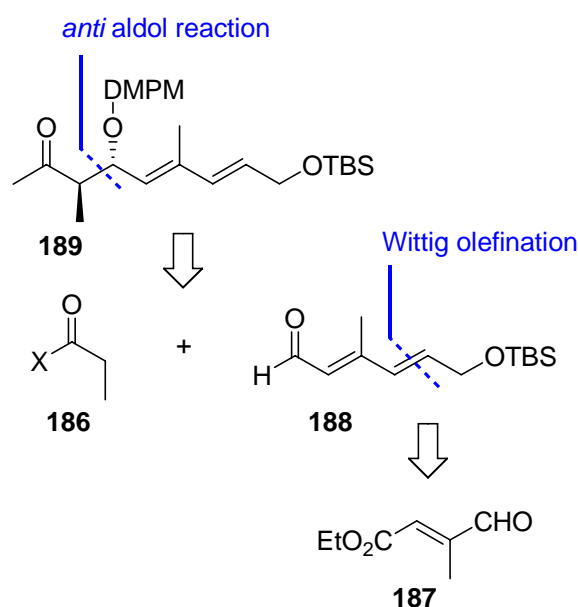


Scheme 48 The synthesis of the C24-C31 subunit **184**.

4.4 Synthesis of the C15-C23 Subunit

Synthesis of the C15-C23 subunit was the focus of this thesis.

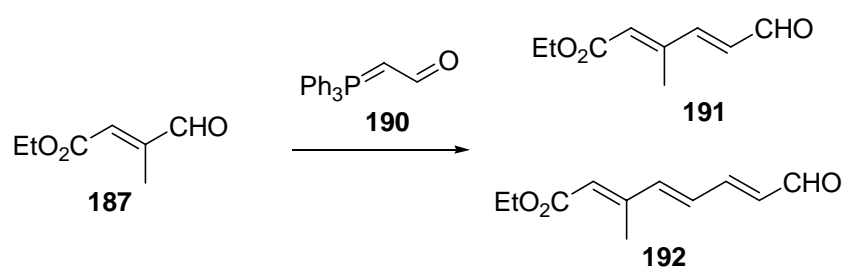
The retrosynthetic analysis of the C15-C23 subunit **189** is outlined in Scheme 49. An auxiliary controlled *anti* aldol reaction would build the corresponding stereochemistry. The aldehyde **188** would be prepared from (*Z*)-ethyl 3-formylbut-2-enoate **187** by using *Wittig* olefination. The DMPM-protection group for the secondary alcohol was selected due to (i) PMB ethers and PMP acetals show high 1,5-*anti* induction by Boron mediated asymmetric aldol reactions¹³⁰ which would be employed for connection of the C15-C23 subunit **189** and the C24-C31 subunit **184**; (ii) the DMPM-protecting group is easier to cleave than the PMB-group.



Scheme 49 Retrosynthetic analysis of the C5-C20 subunit.

4.4.1 Synthesis of the Aldehyde Fragment – *Wittig* Reaction

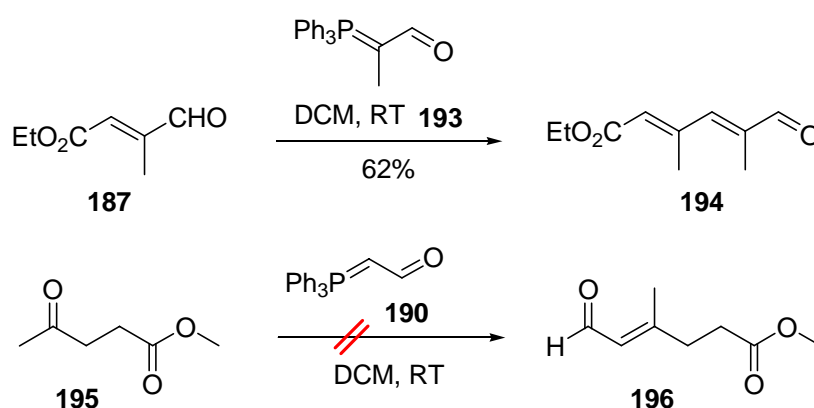
The *Wittig* reaction of **187** to give **191**, as previously reported,¹³¹ was very slow in toluene and gave low yield. On the contrary, this reaction was faster in DCM and gave better yield. Optimum results were obtained in DCM with 1.5 eq. *Wittig* reagent and 1.0 eq. aldehyde **187** at room temperature (Table 2, Entry 4). The side product of the *Wittig* reaction in DCM was the aldehyde **192**, the amount of which may be reduced under the condition with excess of the aldehyde **187** (Table 2, Entry 7). The excess of the aldehyde **187** was recycled after silica gel chromatography.

Scheme 50 *Wittig* reaction with aldehyde **187** and ylide **190**.

Entry	Solvent	187 (eq.)	190 (eq.)	T (°C)	Time (h)	Yield (%)		
						192	191	187
1	PhMe	1.0	1.1	110	24		57	
2	PhMe	1.0	1.1	RT	24 × 7	20	57	15
3	DCM	1.0	1.1	RT	24	13	65	11
4	DCM	1.0	1.5	RT	24	9	70	16
5	DCM	1.0	2.0	RT	24	4	56	27
6	DCM	2.0	1.0	RT	28		79	3.7
7	DCM	3.0	1.0	RT	15		80	2.7

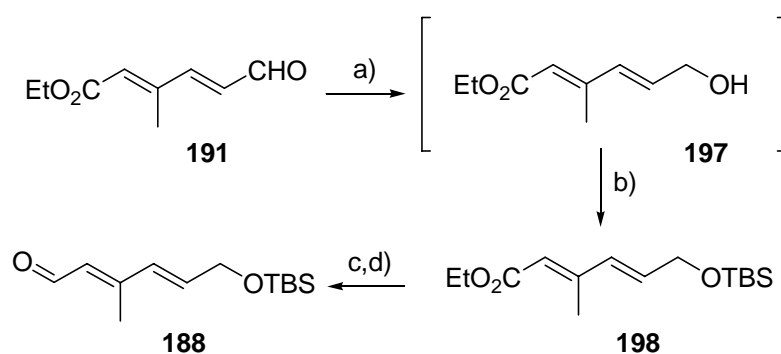
Table 2 Results of the *Wittig* reaction with aldehyde **187** and ylide **190**.

The *Wittig* reaction of the aldehyde **187** (excess) with more sterically hindered ylide **193** give the aldehyde **194** in 62% yield after 24 h at room temperature. Although this type of the *Wittig* reaction with aldehyde **187** proceeded very well in DCM, no conversion of the reaction with the corresponding ketone **195** could be obtained.



Scheme 51 *Wittig* reaction with aldehyde **187** and ylide **193** and unsuccessful *Wittig* reaction with ketone **195** and ylide **190**.

Then, reduction of aldehyde **191** with NaBH_4 , followed by TBS-protection of the primary alcohol afforded the TBS ether **198** in 89% yield over two steps. The primary alcohol **197** was used directly for the next step after work up. Reduction of the ester functionality with DIBAL-H at $0\text{ }^\circ\text{C}$ to the primary alcohol, followed by oxidation of allylic alcohol with MnO_2 and 4 \AA MS in Et_2O gave the aldehyde **188**¹³² in 95% yield over two steps, which was ready for the *anti* aldol reaction.

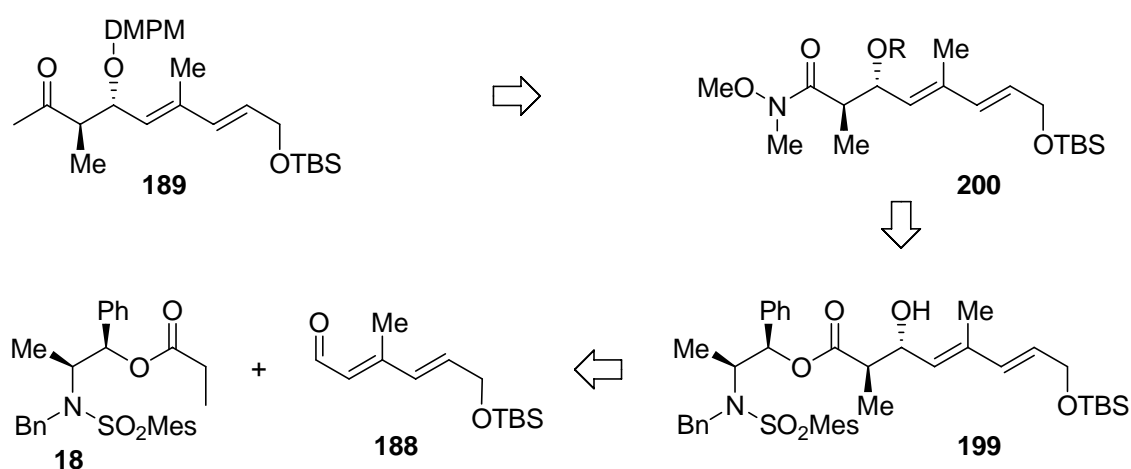


Scheme 52 (a) NaBH_4 , $\text{EtOH}/\text{H}_2\text{O}$ 1:1, $0\text{ }^\circ\text{C}$ to RT, 20 min; (b) TBSCl, imidazole, DMF, RT, 30 min, 89% over 2 steps; (c) DIBAL-H, THF, $0\text{ }^\circ\text{C}$, 1 h, 97%; (d) MnO_2 , Et_2O , 4 \AA MS, RT, 30 min, 95%.

4.4.2 Construction of the Stereocentre C20/C21 – *anti* Aldol Reactions

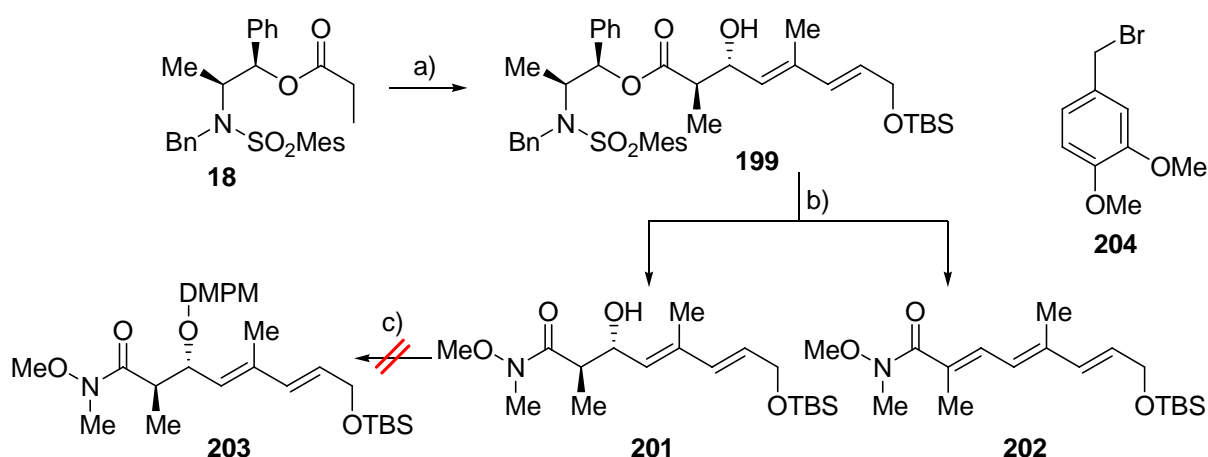
4.4.2.1 The *Abiko-Masamune anti* Aldol Strategy

With the good experience of the *Abiko-Masamune anti* Aldol reaction in course of our total synthesis of archazolid A, we wanted to construct the stereocentres at C20 and C21 in a similar fashion. Accordingly, the aldol adduct **199** should be directly converted to the corresponding *Weinreb* amide **200** using *i*PrMgCl activation of carbonyl by chelation, which was described in total synthesis of archazolid A. Then, conversion of the *Weinreb* amide **200** to the methyl ketone **189** was planned to be carried out by standard conditions.



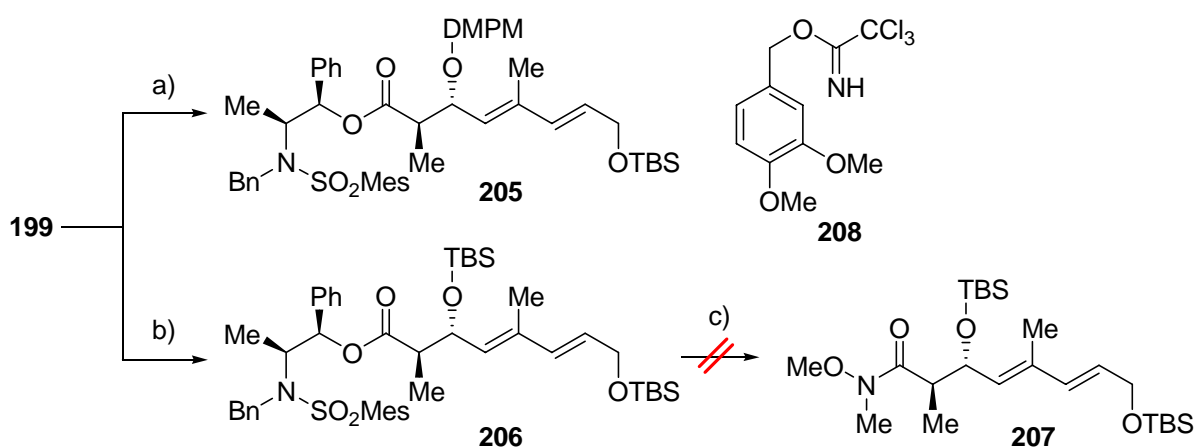
Scheme 53 Retrosynthetic analysis for *Abiko-Masamune anti* aldol strategy.

However, the *Abiko-Masamune anti* aldol reaction between the propionate ester **18** and the aldehyde **188** provided low selectivity and moderate yield (76%, d.r. > 5:1).¹⁰¹ The direct conversion of the aldol adduct **199** with *i*PrMgCl and *O,N*-dimethylhydroxylamine hydrochloride to the *Weinreb* amide **201** was not as good as in the total synthesis of archazolid A. The problem was elimination of the hydroxyl group. This byproduct **202** was obtained in 29%. The basic conditions and the formation of the conjugated system were the cause of the hydroxyl elimination. The protection of the *Weinreb* amide **201** with 4-(bromomethyl)-1,2-dimethoxy benzene **204** and NaH in DMF also failed.¹³³



Scheme 54 (a) $(c\text{Hex})_2\text{BOTf}$, Et_3N , DCM, $-78\text{ }^\circ\text{C}$, 2 h, then **188**, $-78\text{ }^\circ\text{C}$, 1 h, 76%, d.r. > 5:1; (b) $i\text{PrMgCl}$, O,N -dimethylhydroxylamine hydrochloride, $-20\text{ }^\circ\text{C}$ to $0\text{ }^\circ\text{C}$, 3.5 h, 52%; (c) NaH, 4-(bromomethyl)-1,2-dimethoxybenzene **204**, DMF, $0\text{ }^\circ\text{C}$.

Direct protection of the aldol adduct **199** with 3,4-dimethoxybenzyl 2,2,2-trichloroacetimidate **208** and PPTS as catalyst in DCM provided the DMPM ether¹³⁴ only in 47% yield and the product **205** could not be separated from the starting material by silica gel chromatography. On the contrary, the TBS protection of **199** using TBSOTf and 2,6-lutidine in DCM provided the TBS ether **206** in 98% yield. However, the conversion of the TBS ether to corresponding *Weinreb* amide **207** was not successful.

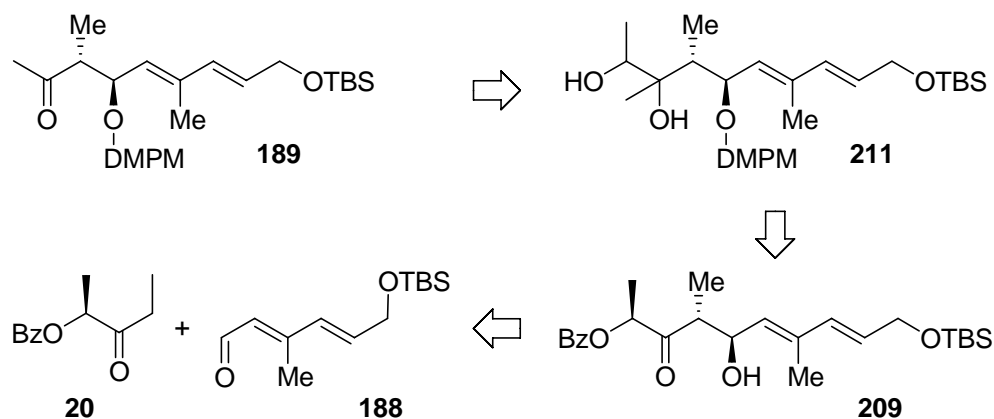


Scheme 55 (a) 3,4-dimethoxybenzyl 2,2,2-trichloroacetimidate **208**, PPTS, DCM, RT, 17 h, 47%; (b) TBSOTf, 2,6-lutidine, DCM, $-78\text{ }^\circ\text{C}$, 1 h, 98%; (c) $i\text{PrMgCl}$, O,N -dimethylhydroxylamine hydrochloride, THF, $-20\text{ }^\circ\text{C}$ to RT.

In conclusion, the *Abiko-Masamude anti* aldol reaction afforded the aldol product **199** in low stereoselectivity and moderate yield. The direct conversion of the aldol product **199** to *Weinreb* amide **201** proceeded also not as smoothly as we had hoped. Due to these unsatisfactory results, we turned our attention to a *Paterson anti* aldol reaction.

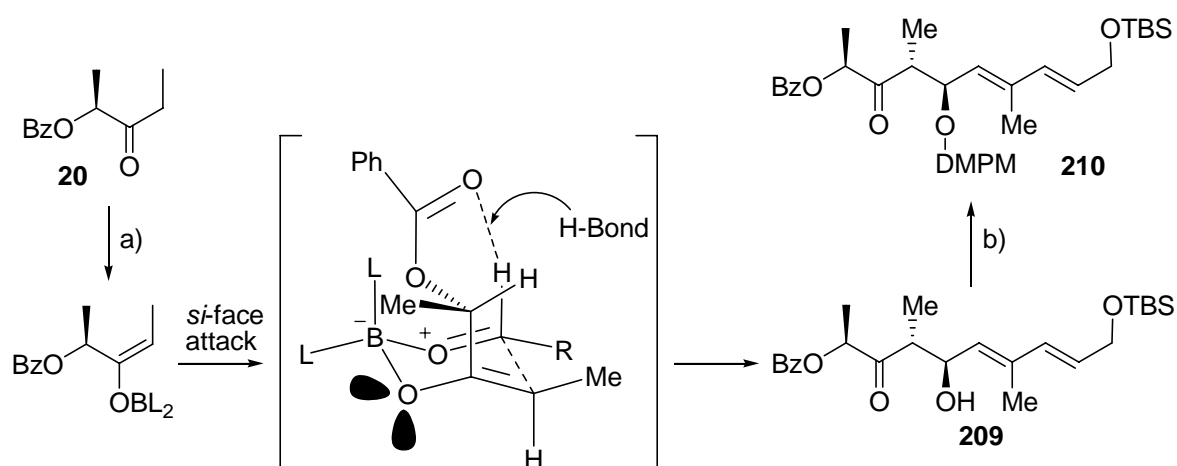
4.4.2.2 The *Paterson anti* Aldol Strategy

With *Paterson anti* aldol reaction, the stereocenters at C20 and C21 could be constructed. After DMPM protection of the aldol adduct **209**, the ketone functionality could be removed by MeLi and the benzoyl could be cleaved concomitantly to provide the 1,2-diol **211**,¹³⁵ that could be converted to methyl ketone **189** by oxidative cleavage (Scheme 56).



Scheme 56 *Paterson anti* aldol reaction followed by DMPM protection.

As shown in Scheme 57, the *Paterson anti* aldol reaction provided in this case high yield (97%) and selectivity (d.r. > 20:1),⁴² in contrast to the *Abiko-Masamude anti* aldol reaction. This reaction was also appropriate to large scale. But the problem was the DMPM protection of the secondary alcohol **209** after the aldol reaction. With various conditions,¹³⁶ the protection gave unsatisfactory results (Table 3). The best result was performed by using PPTS as catalyst. However, the product **210** could not be separated from the starting material by silica gel chromatography, in a similar fashion as was previously observed for the *Abiko-Masamune anti* aldol product.

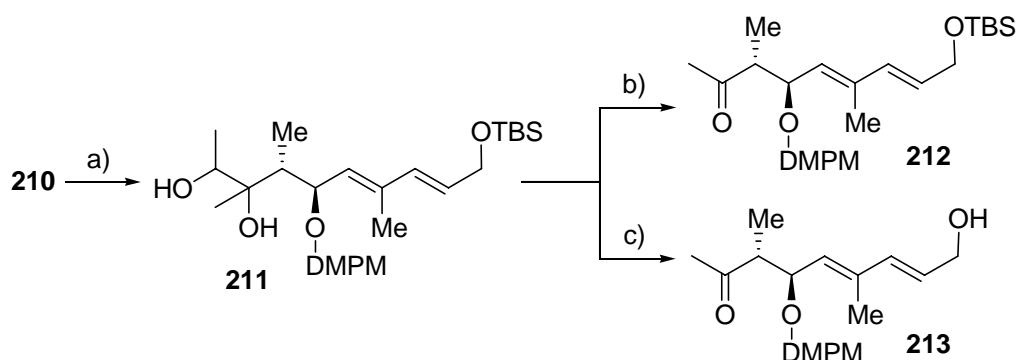


Scheme 57 (a) (cHex)₂BCl, Me₂NEt, Et₂O, -78 °C then 0 °C, 2 h, then aldehyde **188**, -78 °C then -20 °C, 14 h, 97%, d.r. > 20:1; (b) Table 3.

Catalyst	Mol (%)	T (°C)	Yield (%)
PPTS	50	RT	37
CSA	15	RT	23
BF ₃ ·Et ₂ O	4	-78 to RT	decomposition
Sc(OTf) ₃	10	RT	decomposition

Table 3 Results of DMPM protection of *Paterson anti* aldol adduct **209**.

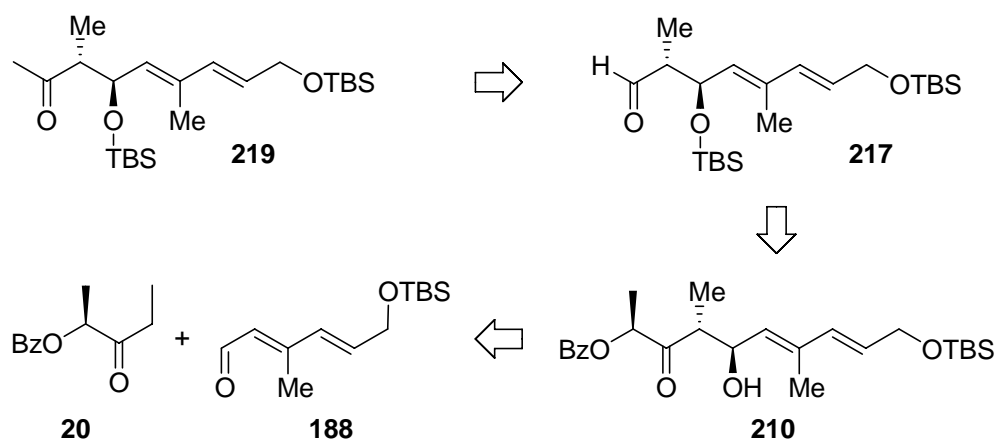
The methyl addition to the ketone functionality with concomitant benzoyl cleavage provided the 1,2-diol **211** only in 22% yield,¹³⁵ which was then converted to the methyl ketone by oxidative cleavage with NaIO₄ in THF/H₂O. It was surprising that the oxidative cleavage with NaIO₄ in THF/H₂O gave different products. In the first case, NaIO₄ (7.0 eq.) was added in three portions over a period of 3.5 h to give methyl ketone **212** with the TBS group. In the second case, NaIO₄ (6.0 eq.) was added in one portion to give methyl ketone **213** without the TBS group. The second case showed that the TBS group was removed under this condition. This cleavage of the TBS group will be discussed below.



Scheme 58 (a) MeLi, Et₂O, -78 °C to -20 °C, 4 h, 22%; (b) NaIO₄ (7.0 eq.), THF/H₂O (4 : 1), RT, 6.5 h, 86%; (c) NaIO₄ (6.0 eq.), THF/H₂O (4 : 1), RT, 2 h, 93%.

After the failure of the DMPM protection, we had to choose an alternative protection group. If β -hydroxyl methyl ketones were protected with TBS group, high levels of 1,5-*anti* induction have been obtained with Ipc-boron controlled enolates. This type of Ipc-boron controlled 1,5-*anti* aldol reaction with a TBS-protected methyl ketone was used in the total synthesis of dolabelide D by *Leighton*.¹³⁷

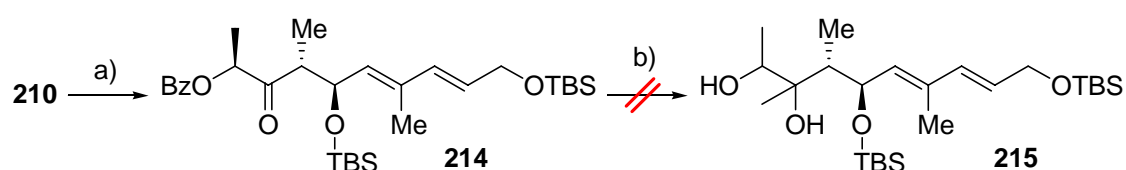
The standard approach was envisioned following *Paterson* aldol reaction to prepare the methyl ketone **219**: reduction of the ketone and ester functionalities, followed by oxidative cleavage of the resulting diol to give the aldehyde **217**, which would then be converted to the methyl ketone **219**.



Scheme 59 *Paterson anti* aldol reaction followed by TBS protection.

As shown in Table 4, the protection of the aldol product **210** with TBSOTf and several organic bases was carried out. The best result was achieved with proton sponge[®] as base. The

reaction with 2,6-lutidine and 2,6-di-tert-butylpyridine proceeded not smoothly and gave lower yields. With 2,4,6-trimethyl pyridine or 2,3,5-collidine as base, elimination of water was observed as side reaction and better yields were obtained. It is known that proton sponge[®] is more basic than 2,4,6-trimethyl pyridine or 2,3,5-collidine. But the elimination of water as side reaction in this case was not found. On the other hand, proton sponge[®] is sterically more hindered as compared to these other bases. This suggests that this steric effect may be the cause of the elimination. The conversion of the TBS-protected aldol product **214** to diol **215** by using methyl lithium led to decomposition. Perhaps, methyl lithium attacks the electron rich allylic TBS ethers moiety in ketone **214**, which then leads to decomposition.¹³⁸



Scheme 60 (a) Table 4; (b) MeLi, Et₂O, -78 °C to -20 °C, decomposition.

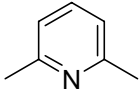
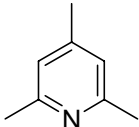
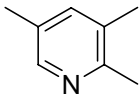
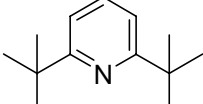
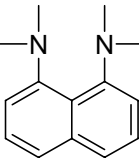
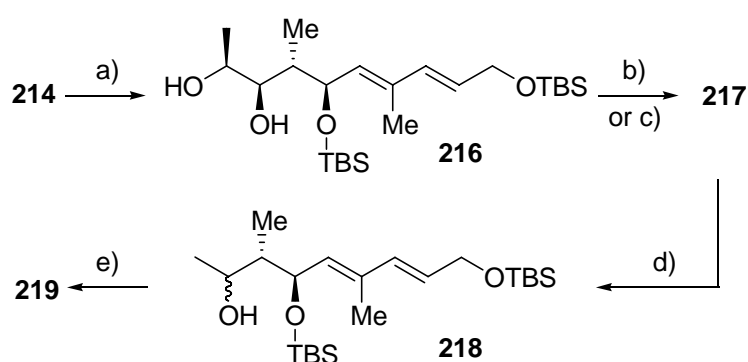
Base	Reagent	Solvent	T (°C)	Side Reaction	Yield (%)
	TBSOTf	DCM	-78	unknown	52
	TBSOTf	DCM	-78	Elimination	81
	TBSOTf	DCM	-78	Elimination	73
	TBSOTf	DCM	-78	unknown	60
	TBSOTf	DCM	-78	unknown	87

Table 4 Results of TBS protection of *Paterson anti* aldol adduct **210**.

Then, we used the standard approach to prepare the methyl ketone. Using LiBH_4 as reducing agent, the ketone and ester functionalities were reduced to the diol **216** in high yield. Oxidative cleavage of the diol **216** with NaIO_4 however gave the aldehyde **217** in 68% yield only. This moderate yield was due to a side reaction, *i.e.* deprotection of the primary TBS ether under these conditions. This type of TBS-deprotection will be discussed below. The oxidative cleavage of the diol **216** with $\text{Pb}(\text{OAc})_4$ in toluene was very clean and fast, giving the aldehyde **217** in very high yield. The other benefit of this reaction was that the diol **216** was used without purification after workup for the next step. The aldehyde **217** may be converted to the methyl ketone **219** by using two a two step procedure in 75% yield.



Scheme 61 (a) LiBH_4 , THF, $-78\text{ }^\circ\text{C}$ to RT, 24 h; (b) NaIO_4 , MeOH/ H_2O (2:1), RT, 4 h, 62% over 2 steps; (c) $\text{Pb}(\text{OAc})_4$, PhMe, RT, 25 min, 90% over 2 steps; (d) MeLi, Et_2O , $-78\text{ }^\circ\text{C}$, 30 min, then $-30\text{ }^\circ\text{C}$, 30 min; (e) DMP, NaHCO_3 , DCM, RT, 90 min, 75% over 2 steps.

4.4.3 Conclusion

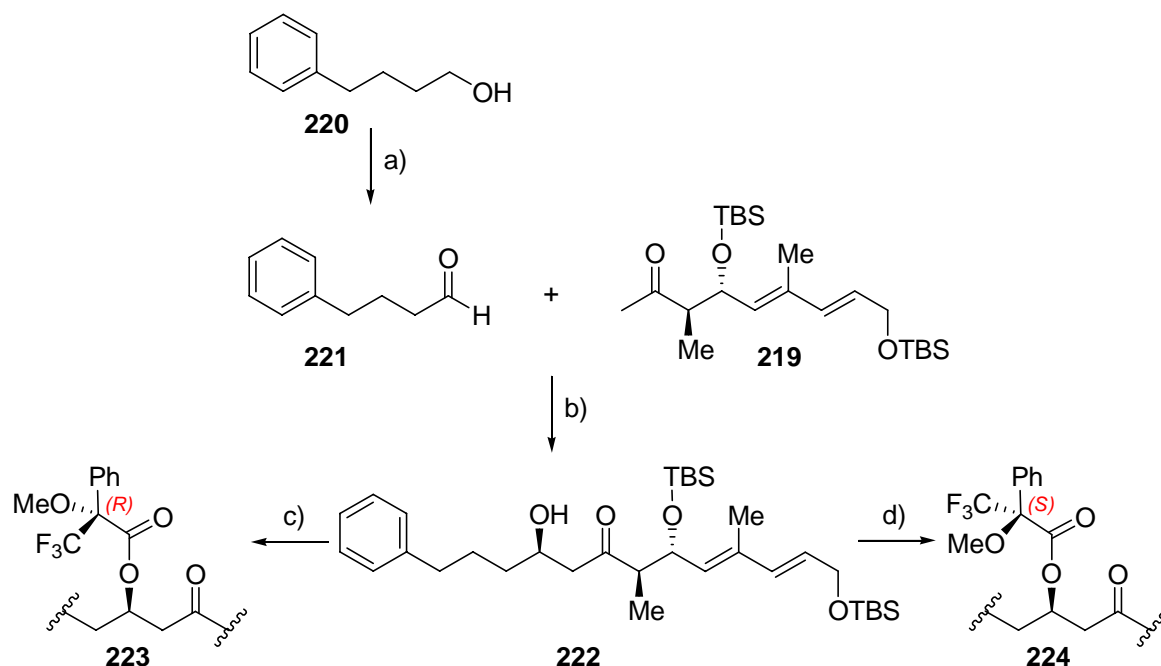
During the synthesis of the C15-C23 subunit, two auxiliary-controlled *anti* selective aldol reactions involve *Abiko-Masamune anti* aldol and *Paterson anti* aldol were evaluated to construct the stereocentres at C20 and C21. Most efficiently, the two stereocentres were installed by using *Paterson anti* aldol reaction. The *Wittig* reaction of aldehyde **187** and ylide **190** was optimized and amenable to produce multigrams. Under optimized conditions, the *Wittig* reaction of the aldehyde **187** (excess) with more sterically hindered ylide **193** give the aldehyde **194** in good yield. In addition, the TBS protection of the *Paterson anti* aldol adduct **210** with different amine bases were studied. With proton sponge[®] as base, this type of protection give excellent yield. In total, subunit **219** was obtained in 11 steps with 37% yield from aldehyde **187** in a well-scalable providing several grams of the desired building block.

4.5 Connection of the C15-C23 and the C24-C31 Subunits

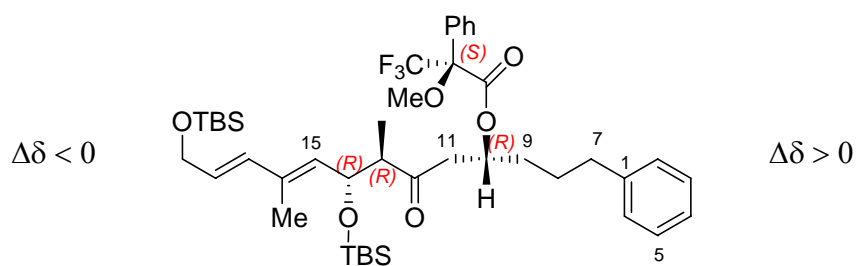
With the methyl ketone **219** and the aldehyde **184** subunits in hand, the connection of this two subunits could be carried out according to our synthesis plan. Before the two subunits would be connected by using Ipc-boron aldol reaction, a model reaction with the aldehyde **221** and the methyl ketone **219** was carried out to check the selectivity of this asymmetric aldol reaction.

4.5.1 The Model Ipc-Boron Aldol Reaction with Methyl Ketone **219**

As show in Scheme 62, the alcohol **220** was oxidized with DMP to aldehyde **221**. The Ipc-boron aldol reaction between the aldehyde **221** and the methyl ketone **219** provided moderate yield (50%) and good selectivity (d.r. > 12:1). The absolute configuration of the new stereocentre was deduced by *Mosher*-ester analysis of the bis-*Mosher* ester **223/224** of the alcohol **222**.¹³⁹



Scheme 62 (a) DMP, DCM, RT, 1 h, 94%; (b) (+)-DIPICl, Et₃N, Et₂O, 0 °C, 90 min; then aldehyde **221**, -78 °C to RT, 18 h, 50%, d.r. > 12:1; (c) (*R*)-MTPA, DMAP, Et₃N, 2,4,6-trichlorobenzoyl chloride, PhMe, RT, 20 min, 88%; (d) (*S*)-MTPA, DMAP, Et₃N, 2,4,6-trichlorobenzoyl chloride, PhMe, RT, 20 min, 98%.

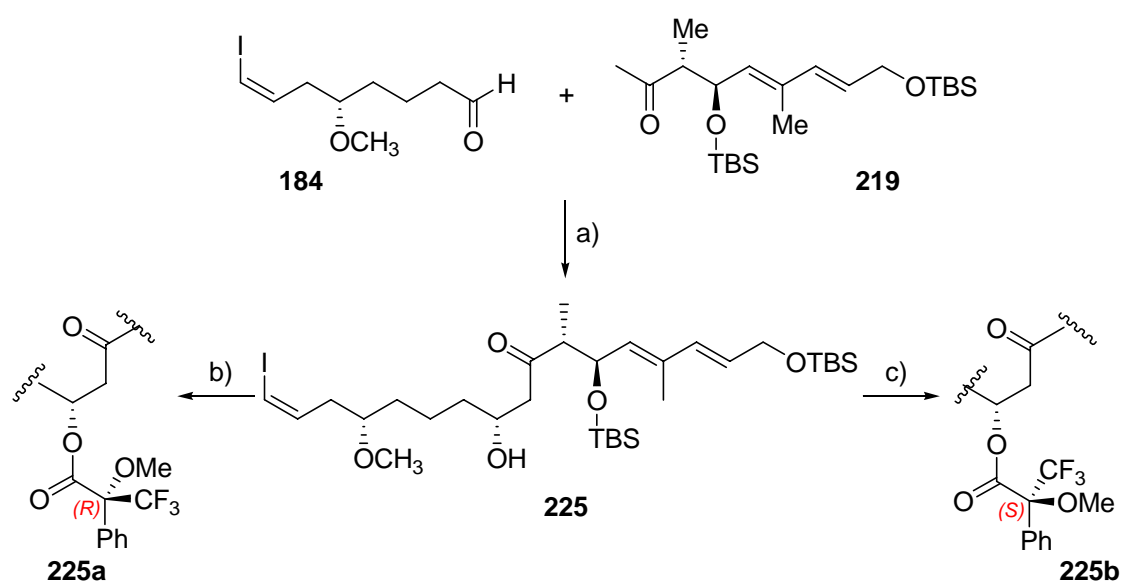


H	δ [ppm] <i>S</i> -Mosher ester	δ [ppm] <i>R</i> -Mosher ester	$\Delta\delta = \delta_S - \delta_R$
7	2.61	2.54	+0.07
8,9	1.68	1.62	+0.06
11a	2.88	2.93	-0.05
11b	2.68	2.71	-0.03
13	2.53	2.59	-0.06
Me-13	0.67	0.78	-0.11

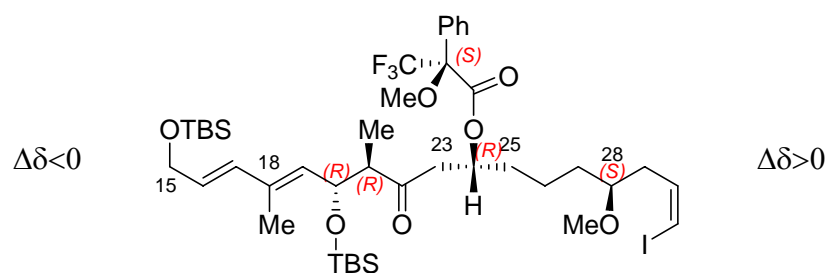
Table 5 *Mosher* ester analysis of the model Ipc-boron aldol reaction.

4.5.2 The Ipc-Boron Aldol Reaction

The connection of the methyl ketone **219** and the aldehyde **184** subunits was performed successfully by using Ipc-boron aldol reaction in good yield and selectivity (Scheme 63). Enolization of methyl ketone **219** with (+)-DIPCl in conjunction with Et₃N in Et₂O at 0 °C led to the formation of the boron enolate, which was allowed to react with aldehyde **184** at -78 °C for 2 h and then at -20 °C for 14 h. The desired product **225** was obtained in 76% yield and good selectivity (d.r. > 14:1). The absolute configuration of C24 was deduced by Mosher-ester analysis of the bis-Mosher ester **225a/225b** of the alcohol **225**.¹³⁹



Scheme 63 (a) (+)-DIPCl, Et₃N, Et₂O, 0 °C, 1 h, then aldehyde **184**, -78 °C, 2 h, then -20 °C, 14 h, 76%, d.r. > 14:1; (b) (R)-MTPA, DMAP, Et₃N, 2,4,6-trichlorobenzoyl chloride, PhMe, RT, 20 min, 89%; (c) (S)-MTPA, DMAP, Et₃N, 2,4,6-trichlorobenzoyl chloride, PhMe, RT, 20 min, 90%.



H	δ [ppm] S-Mosherester	δ [ppm] R-Mosherester	$\Delta\delta = \delta_S - \delta_R$
25	1.676	1.612	+0.064
26,27	1.493	1.398	+0.095
28	3.255	3.187	+0.068
Me-28	3.319	3.295	+0.024
29	2.328	2.296	+0.032
23a	2.684	2.736	-0.052
23b	2.904	2.950	-0.046
21	2.555	2.607	-0.052
Me-21	0.674	0.779	-0.105
20	4.525	4.555	-0.030
19	5.210	5.226	-0.016
Me-18	1.763	1.779	-0.016

Table 6 Mosher ester analysis of the Ipc-boron aldol reaction.

As shown in Figure 19, it is postulated that the boron aldol reactions of β -hydroxy methyl ketone proceed *via* a boat transition state.¹⁴⁰ For β -alkoxy methyl ketones, a stabilizing formyl hydrogen bond exists that leads to disfavouring of the 1,5-*syn* adduct by minimizing steric interactions between the β -alkyl group and one of the Ipc group on boron. Silyl protecting groups prevent formyl hydrogen bonding due to their large size and electron-deficient oxygen. So, the high levels of stereocontrol, which was achieved with TBS-protected β -hydroxy methyl ketones, may be realised through the reinforcing influence of an Ipc-boron enolate.¹⁴¹

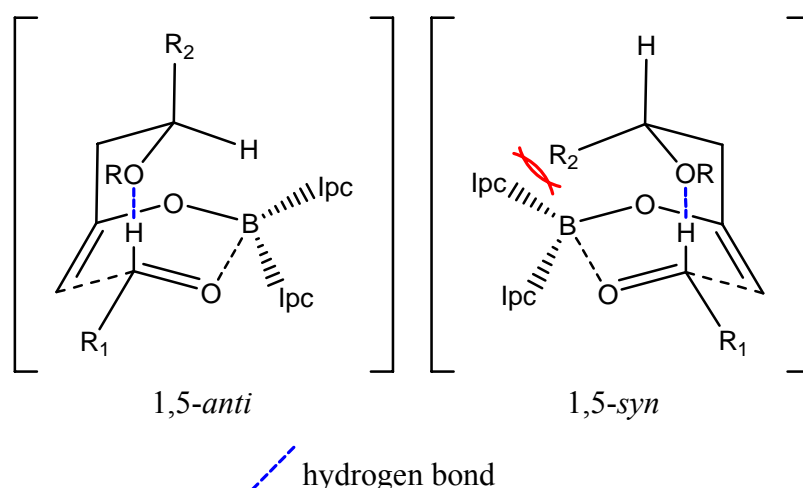


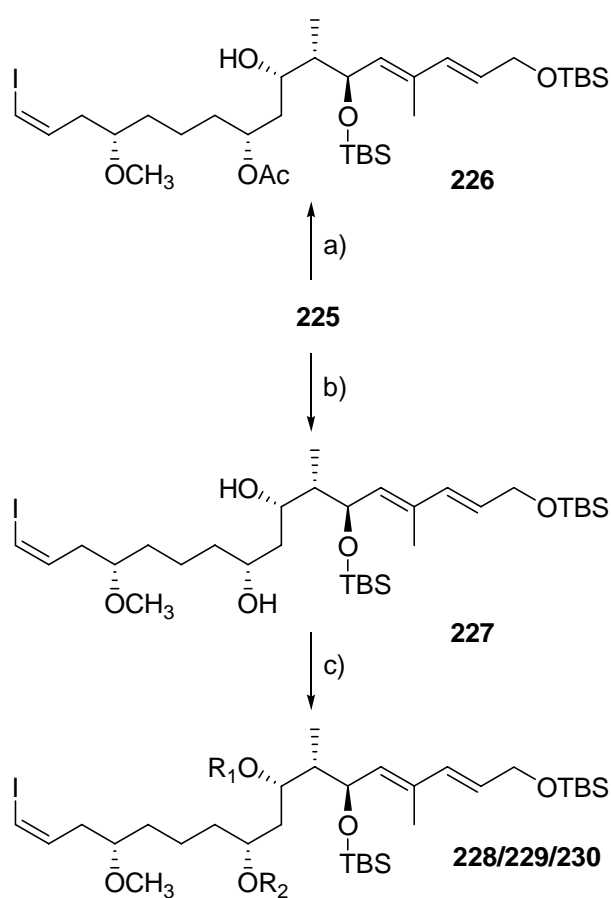
Figure 19 Boat transition states of the Ipc-boron aldol reaction.

4.5.3 Reduction of the Ketone **225** and Selective Protection of the Diol **227**

The reduction of the β -hydroxy ketone **225** to the diol with the desired new stereocenter could be carried out by using two asymmetric reduction methods, the *Evans-Tishchenko* reduction¹⁴² and the *Saksena-Evans* reduction.¹⁴³ Using SmI_2 and MeCHO in THF, the β -hydroxy ketone **225** was reduced to the desired alcohol **226** in 93% yield, with complete diastereoselectivity and with concomitant protection of the hydroxyl group at C24 as acetate. However, cleavage of the acetyl group in competition to the macrolacton after the closing of the ring was envisioned to be problematic. Reduction of the β -hydroxy ketone **225** using tetramethylammoniumtriaceoxy-borohydride afforded the diol **227** in 92% yield and complete diastereoselectivity.

In these cases, the *anti* stereoselectivity can be rationalized by intramolecular hydride transfer *via* cyclic transition state as shown in Figure 20.

Using of TBSCl and imidazol in DCM at RT, the diol **227** could be selectively protected as TBS ether **228** at C24 in 63% (77%, based on rec. SM). As by-products, the TBS ether **229** at C22 and the bis-TBS ether (C22 and C24) **230** were isolated and also the diol **227** was recycled in 18% yield. The selective protection of hydroxyl group at C24 was also carried out with TBSOTf and 2,6-lutidine or proton sponge[®], however giving lower selectivity.



Scheme 64 (a) SmI_2 , MeCHO , THF, $-10\text{ }^\circ\text{C}$, 1 h, then $-20\text{ }^\circ\text{C}$, 16 h, 93%; (b) $\text{Me}_4\text{NBH}(\text{OAc})_3$, MeCN/AcOH (1:1), -40 then $-22\text{ }^\circ\text{C}$, 40 h, 92%; (c) TBSCl , imidazole, DCM , RT, 30 min, **228**: $\text{R}_1 = \text{H}$, $\text{R}_2 = \text{TBS}$, 63%; **229**: $\text{R}_1 = \text{TBS}$, $\text{R}_2 = \text{H}$, 9%; **230**: $\text{R}_1 = \text{R}_2 = \text{TBS}$, 4%; **227**: $\text{R}_1 = \text{R}_2 = \text{H}$, 18%.

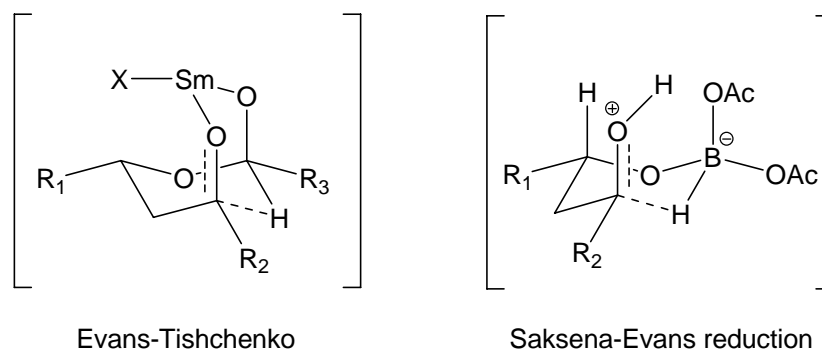
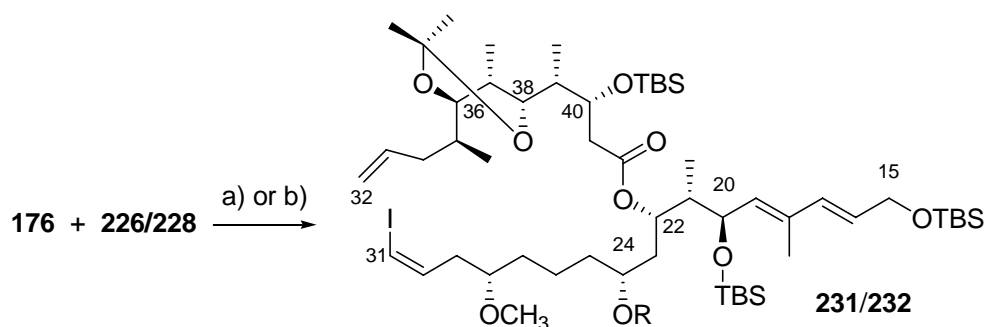


Figure 20 Transition state of intra-molecular hydride transfer.

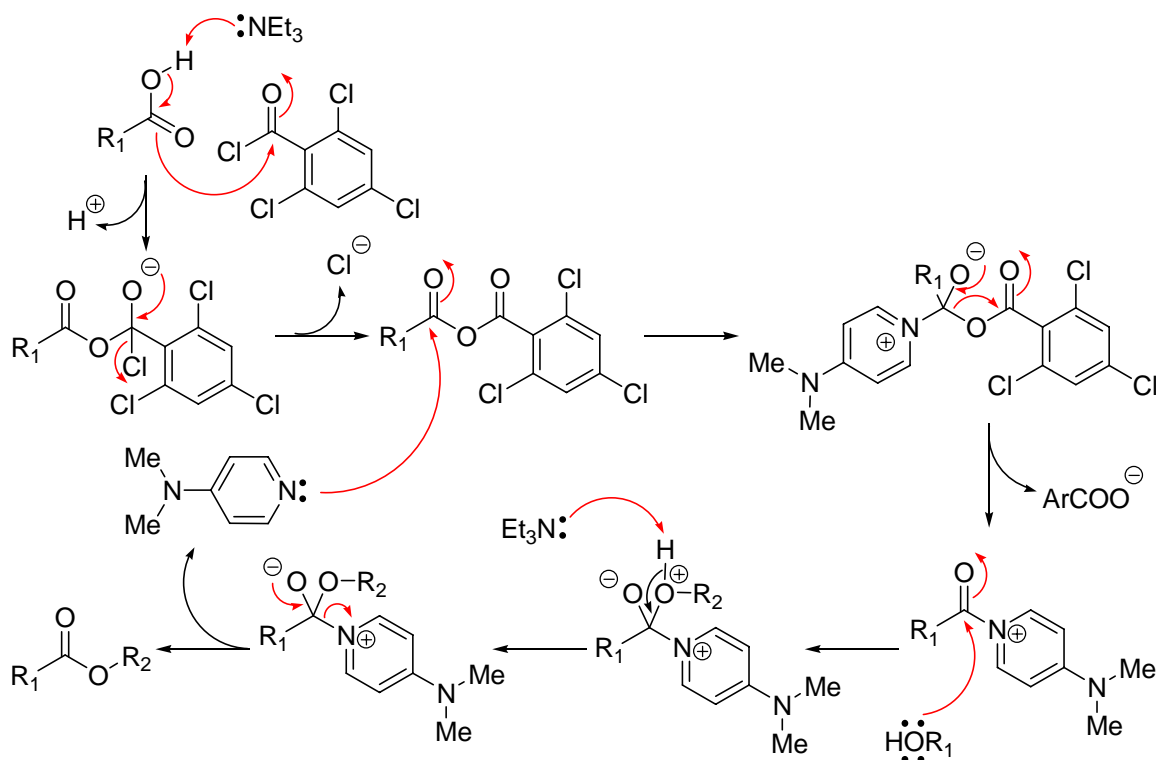
4.6 Connection of the C15-C31 and the C32-C42 Subunits

Under standard *Yamaguchi* conditions¹⁴⁴ (formation of the mixed anhydride by treatment with TCBC/Et₃N, followed by DMAP promoted esterification) the esterification of the alcohol **226/228** with acid **176** led to the desired product **231/232** in high yield.



Scheme 65 (a) **231**: R = Ac, TCBC, DMAP, Et₃N, PhMe, 0 °C, 30 min, 87%; (b) **232** R = TBS, TCBC, DMAP, Et₃N, PhMe, 0 °C then RT, 30 min, 97%.

The proposed catalytic cycle and the activated intermediates are shown in Scheme 66.¹⁴⁵

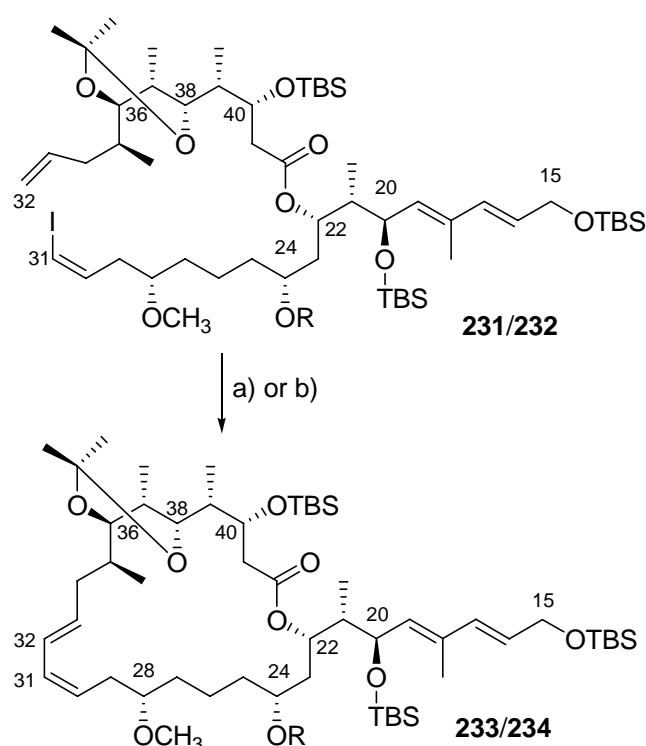


Scheme 66 Proposed mechanism of the *Yamaguchi* esterification.

4.7 Completion of the Macrolide Moiety: *Heck*-Macrocyclization

The intra-molecular *Heck* reaction for medium size rings is widely used in synthetic organic chemistry¹⁴⁶ and also examples have been described for macrocyclization in the total synthesis of natural products and their analogues.¹⁴⁷

In order to close the ring of etnangien, various coupling reactions were considered, for example *Stille*, *Heck* and *Suzuki* reactions, which could be applied for the macrocyclization. But the *Heck* reaction is the most direct because it does not require an activation of functionalization of the second double bond. In this case, various catalytic systems were tested as shown in Table 7. The catalytic systems $\text{PdCl}_2(\text{MeCN})_2 / \text{Et}_3\text{N} / \text{HOCO}$ in MeCN or in DMF and $\text{Pd}(\text{PPh}_3)_4 / \text{Et}_3\text{N} / \text{MeCN}$ led to decomposition. The system $\text{PdCl}_2(\text{PPh}_3)_2 / \text{K}_2\text{CO}_3 / \text{Bu}_4\text{NCl}$ in DMF provided the desired product, but in very low yield. It was found that the system $\text{Pd}(\text{OAc})_2 / \text{K}_2\text{CO}_3 / \text{Bu}_4\text{NCl}$ in DMF¹⁴⁸ was the best for the *Heck* macrocyclization to close the ring of etnangien (Scheme 67). It is possible to obtain high levels of stereocontrol through the nature of the ring conformation and the nature of *E*-selectivity of the *Heck* reaction, as demonstrated in our archazolids synthesis.

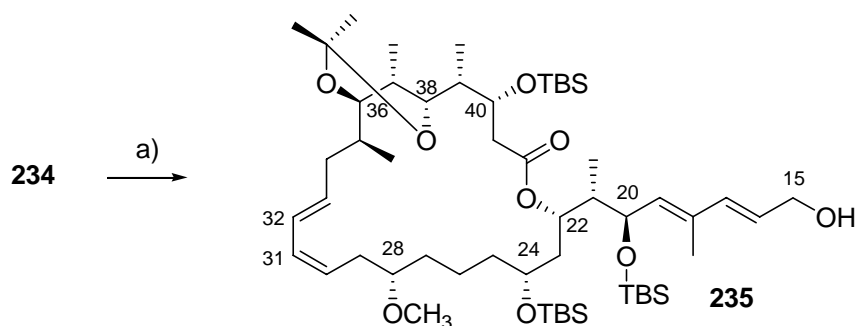


Scheme 67 (a) **233**: R = Ac, $\text{Pd}(\text{OAc})_2$, K_2CO_3 , Bu_4NCl , DMF, 60 °C, 1 h, 34%; (b) **234**: R = TBS, $\text{Pd}(\text{OAc})_2$, K_2CO_3 , Bu_4NCl , DMF, 70 °C, 1 h, 70%.

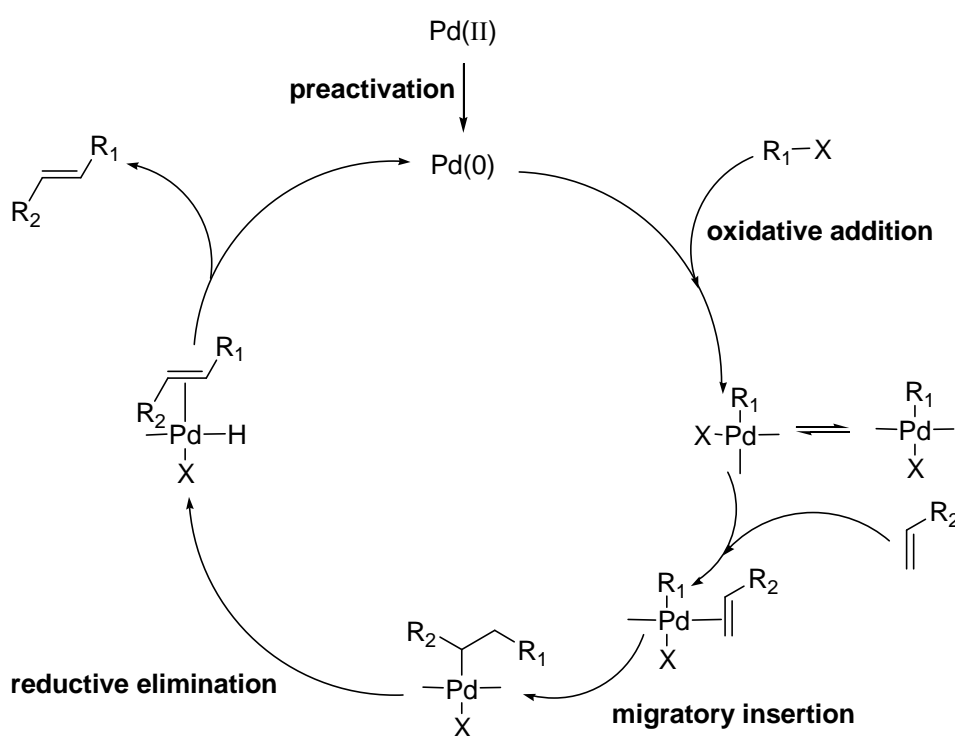
Catalyst	Solvent	Base Additive	T (°C)	Time (h)	Yield R = TBS (%)
$\text{PdCl}_2(\text{MeCN})_2$	MeCN	Et_3N HOCO	RT	22	decomposition
$\text{PdCl}_2(\text{MeCN})_2$	DMF	Et_3N HOCO	RT	3	decomposition
$\text{Pd}(\text{PPh}_3)_4$	MeCN	Et_3N	50	1	decomposition
$\text{PdCl}_2(\text{PPh}_3)_2$	DMF	K_2CO_3 Bu_4NCl	80	0.5	found
$\text{Pd}(\text{OAc})_2$	DMF	K_2CO_3 Bu_4NCl	70	1	70

Table 7 Heck macrocyclization with various catalytic systems.

Following, deprotection of the primary allylic TBS ether with NH_4F in MeOH ¹⁴⁹ at room temperature provided the primary allylic alcohol **235**, which may then be oxidized with MnO_2 to the aldehyde for *Wittig* reaction with the side chain **161** ($\text{R}_1 = \text{Bu}_3\text{PCH}$) or extended by using *Takai* reaction for attachment of the side chain **161** ($\text{R}_1 = \text{Bu}_3\text{Sn}$) by *Stille* coupling, or using a *Wittig* olefination for *Heck* coupling with side chain **161** ($\text{R}_1 = \text{I}$).

Scheme 68 (a) NH_4F , MeOH , RT, 18 h, 70%.

Scheme 69 presents a simplified scheme of the putative major mechanistic steps of the *Heck* catalytic cycle.¹⁵⁰ Several elementary steps are discussed. (i) Preactivation, the reduction of Pd(II) complexes to Pd(0) and the generation of an active species through multiple ligand exchange equilibria. (ii) Oxidative addition: the oxidative addition proceeds as a concerted process in which C-X bond rupture is more or less synchronized with the formation of M-C and M-X bonds. (iii) Migratory insertion: the migratory insertion is the product-forming step of the *Heck* cycle, in which a new C-C bond is formed. It is this step which is most likely responsible for regio- and stereodiscrimination as well as substrate selectivity. (iv) Reductive elimination: after the migratory insertion comes the step in which palladium(0) is released and launches the next turn of the *Heck* cycle. (v) PdH elimination: after reductive elimination, PdH is coordinated to alkene and then scavenged fast by base,

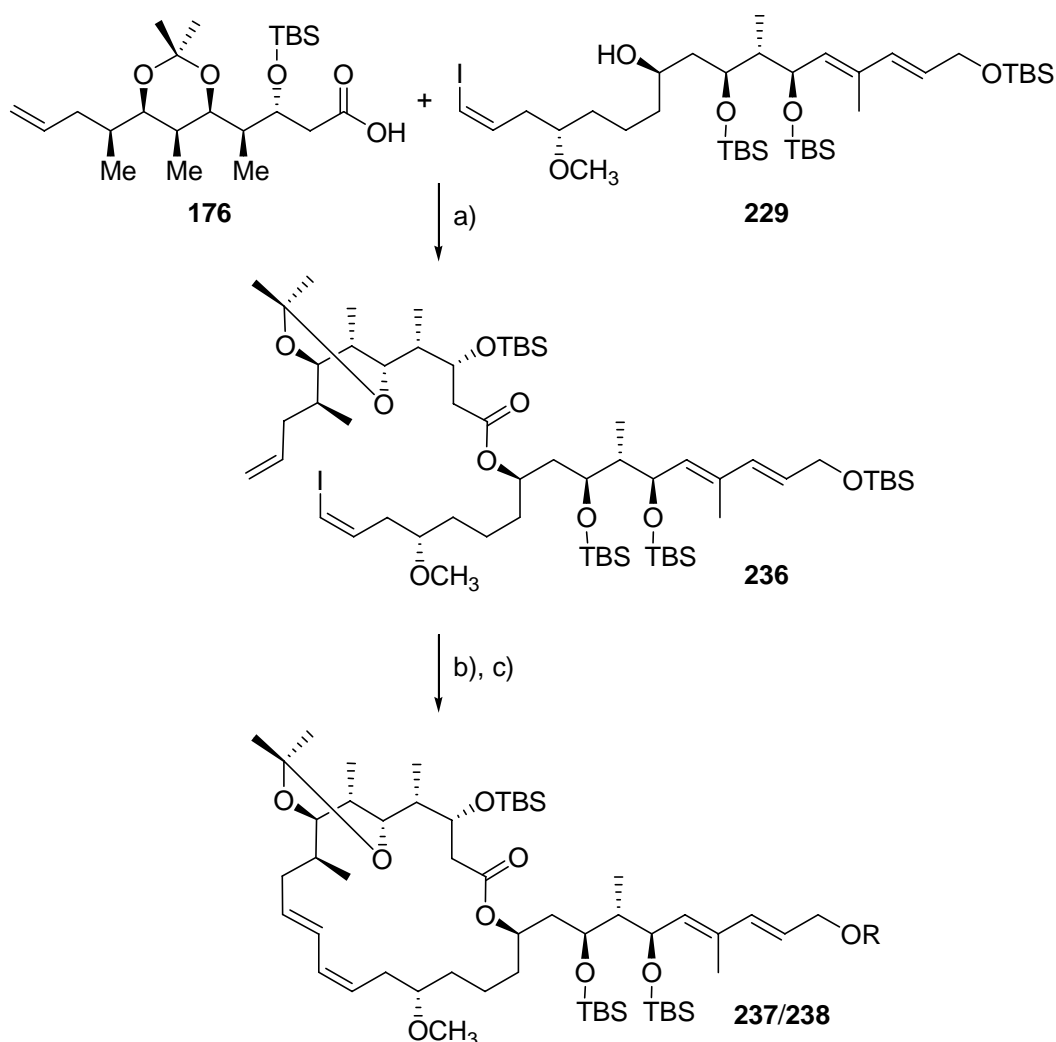


Scheme 69 Proposed catalytic cycle of *Heck* reaction.

4.8 Synthesis of Analogues of the Etnangien Macrolide Structure

4.8.1 Heck Macrocyclization

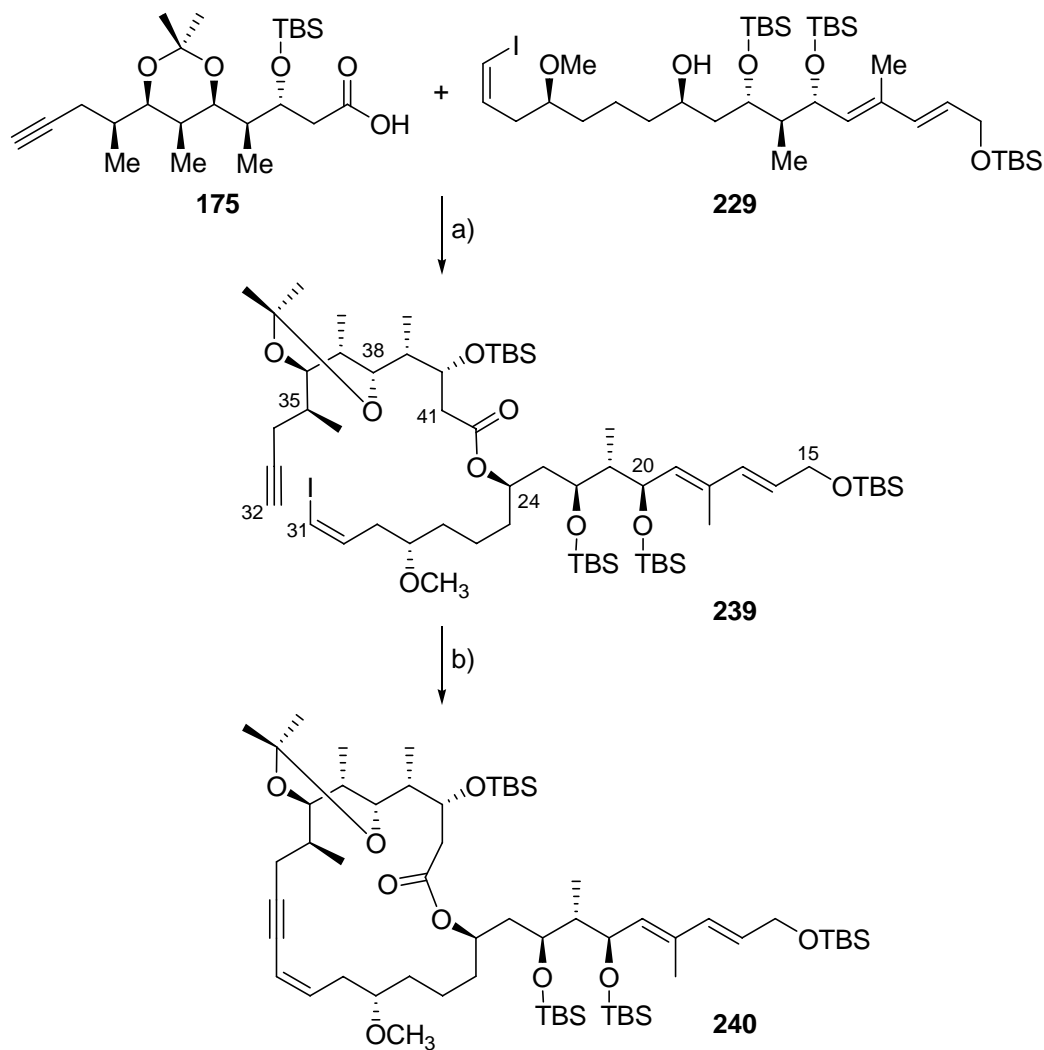
In the same fashion, the esterification of the acid **176** with the alcohol **229**, which was a sideproduct by selective protection of diol **227**, under standard *Yamaguchi* conditions led to the product **236**, which underwent the *Heck* macrocyclization with Pd(OAc)₂ / K₂CO₃ / Bu₄NCl as catalytic system to the macrocycle **237**. After global deprotection, biologic activity of the macrocycle may be tested for structure-activity relationship (SAR) studies. The primary TBS group was selectively removed with NaIO₄ in THF/H₂O to give the primary alcohol **238** in high yield. This mild desilylation method will be discussed below.



Scheme 70 (a) TCBC, DMAP, Et₃N, PhMe, 0 °C then RT, 30 min, 92%. (b) **237**: R = TBS, Pd(OAc)₂, K₂CO₃, Bu₄NCl, DMF, 70 °C, 1 h, 32%. (c) **238**: R = H, NaIO₄ (6.0 eq.) THF/H₂O (4:1), RT, 15 h, 84%.

4.8.2 *Sonogashira* Macrocyclization

Under standard *Yamaguchi* conditions, the esterification of the acid **175** with the alcohol provided the product **239**, which underwent *Sonogashira* macrocyclization with Pd(dba)₃ / CuI / *i*Pr₂Net as catalytic system to the macrocycle **240**.¹⁵¹ After global deprotection, biologic activity of the macrocycle may be tested for structure-activity relationship (SAR) studies.



Scheme 71 (a) TCBC, DMAP, Et₃N, PhMe, 0 °C then RT, 30 min, 82%. (b) Pd(dba)₃, CuI, *i*Pr₂NEt, RT, 70 min, 30%.

4.9 Conclusion

The macrocycle **234** of etnangien (**14**) was successfully synthesized with three key building blocks (**176**, **184**, **219**) by employing highly enantio- and diastereoselective Ipc-boron-mediated (1,5)-*anti* aldol reaction, highly efficient *Yamaguchi* esterification and highly *E*-selective *Heck* macrocyclization. It proceeds in 18 steps and 27% overall yield from **168** (longest linear sequence). Key transformations include two highly enantio- and diastereoselective *Paterson anti* aldol reactions, a tin-mediated (1,4)-*syn* aldol reaction, a silicium-based asymmetric allylation, a (1,3)-*anti* reduction reaction and a (1,3)-*syn* reduction reaction on an advanced intermediate to install the corresponding stereogenic centres at C20/C21, C39/C40, C36/C37, C28, C22 and C38 together with a optimized *Wittig* reaction to generate the 16*E* alkene. In addition, two analogues of the macrocycle (**238**, **240**) were synthesized using *Heck* macrocyclization and *Sonogashira* macrocyclization, respectively. The two analogues are envisioned for structure-activity relationship (SAR) studies.

5 Selective Deprotection of Silyl Ethers with NaIO₄

5.1 Introduction

As synthetic targets such as natural products and their analogues have grown more complex, protection/deprotection methods have assumed prominent roles in synthetic organic chemistry.^{152,153,154} The ability to efficiently protect and then deprotect hydroxyl groups has become increasingly important due to the abundance of these groups in natural products. The transformation of alcohols to the corresponding silyl ethers is a very common way to protect hydroxyl groups. Selective deprotection of one silyl ether without affecting another silyl ether in the same molecule plays important roles and can be a crucial step in total synthesis of natural products and their analogues.¹⁵⁵ Generally, silyl ethers may be deprotected under (i) acidic conditions; (ii) basic/nucleophilic conditions;¹⁵⁶ and (iii) oxidative conditions.¹⁵⁷

Selective deprotection of primary TBS ethers in the presence of secondary TBS ethers is perhaps a most widely used strategy in total synthesis of natural products and their analogues. Reagents which are used in this strategy include HOAc/THF/H₂O,¹⁵⁸ CSA,¹⁵⁹ PPTS,¹⁶⁰ TsOH,¹⁶¹ TFA,¹⁶² HCl,¹⁶³ NH₄F/MeOH/H₂O,¹⁶⁴ DDQ/CH₂Cl₂,¹⁶⁵ quinolinium fluorochromate,¹⁶⁶ *Vilsmeier-Haack* reagent (POCl₃/DMF),¹⁶⁷ ceric ammonium nitrate [CAN, (NH₄)₂Ce(NO₃)₆],¹⁶⁸ CBr₄ in alcohol solvents,¹⁶⁹ LiBr with 18-crown-6 in acetone.¹⁷⁰

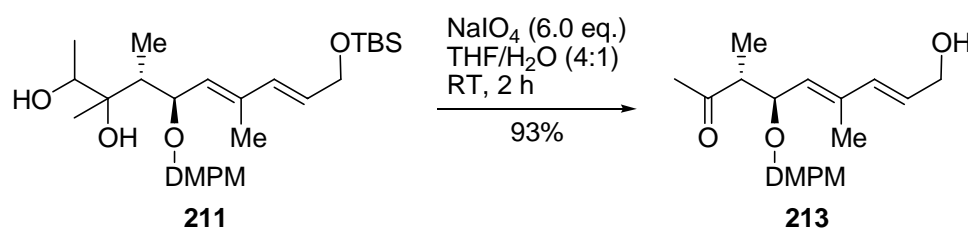
The well-established methods of deprotection of primary TES or TBS ethers in the presence of primary TBDPS ethers include HOAc/THF/H₂O,¹⁷¹ HCl,¹⁷² H₂SO₄,¹⁷³ PPTS,¹⁷⁴ CSA,¹⁷⁵ TsOH,¹⁷⁶ TFA¹⁷⁷ and AcCl/MeOH (generating dry HCl *in situ*).¹⁷⁸ There are also many other methods to remove TBS groups from protected primary alcohols in the presence of primary TBDPS ethers such as LL-ALPS-SO₃H (lowloading and alkylated polystyrene-supported sulfonic acid),¹⁷⁹ HF-pyridine,¹⁸⁰ Lewis acids [CeCl₃·7H₂O/NaI/MeCN,¹⁸¹ Ce(OTf)₄/THF/MeOH,¹⁸² InCl₃/MeCN,¹⁸³ ZnBr₂/H₂O/CH₂Cl₂,¹⁸⁴ Zn(BF₄)₂,¹⁸⁵ CeCl₃·7H₂O¹⁸⁶], Verkade's non-ionic base [P(MeNHCH₂CH₂)₃N],¹⁸⁷ Br₂,¹⁸⁸ I₂,¹⁸⁹ IBr/CH₂Cl₂,¹⁹⁰ TBAB/MeOH.¹⁹¹

A frequently used method to cleave secondary TES ethers in the presence of secondary TBS or TBDPS ethers is acid-mediated deprotection. The acid reagents involve PPTS,¹⁹² TsOH,¹⁹³ TFA,¹⁹⁴ CSA,¹⁹⁵ AcOH,¹⁹⁶ HCl,¹⁹⁷ H₂SO₄.¹⁹⁸ A number of other examples of the deprotection of secondary TES ethers in the presence of secondary TBS ethers are reported like HF-pyridine in THF,¹⁹⁹ aqueous HF in MeCN,²⁰⁰ HOAc-buffered TBAF in THF,²⁰¹ TBAF in THF,²⁰² aqueous NaOH in DMPU.²⁰³

In this chapter we describe a new, selective, mild and facile deprotection method for silyl ethers.

5.2 Result and Discussion

By the execution of oxidative cleavage of diol **211** with NaIO₄ in THF/H₂O, the deprotected product **213** was obtained in high yield (Scheme 72).²⁰⁴ This indicated that the TBS group was removed under the oxidative cleavage conditions.



Scheme 72 Oxidative cleavage of diol **211** with concomitant deprotection of TBS ether.

Are only the primary allylic TBS ethers deprotected? To answer this question we have studied the cleavage of TBS groups under NaIO₄ in THF/H₂O conditions. The results are shown in Table 8 and illustrate that primary TBS ethers including allylic were selectively deprotected with NaIO₄ in THF/H₂O in presence of secondary TBS ethers including allylic, giving products in high yield. This cleavage method is mild and should enable applications to sensitive, acid- or base-labile or polyfunctional substrates (Entry 2, 5, 6, 7).

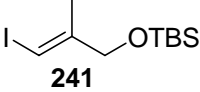
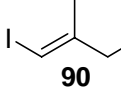
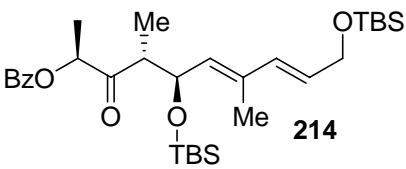
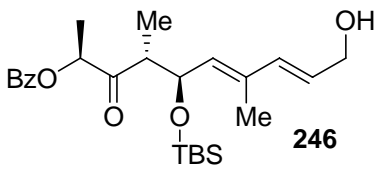
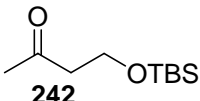
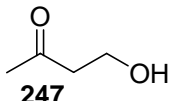
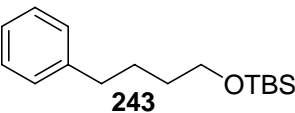
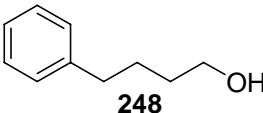
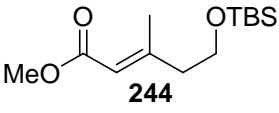
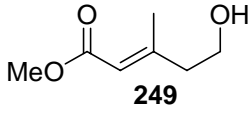
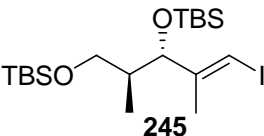
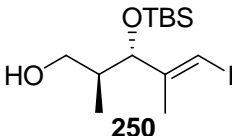
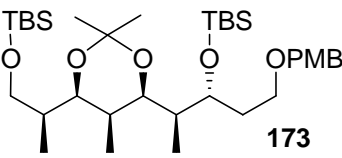
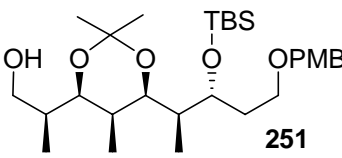
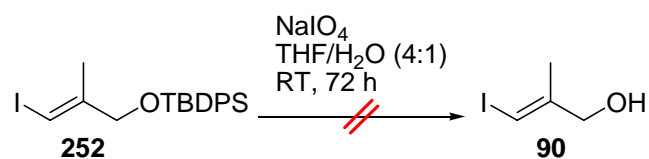
Entry	Substrate	T (h)	Product	Yield (%)
1	 241	2	 90	90
2	 214	3	 246	94
3	 242	2	 247	92
4	 243	2	 248	92
5	 244	2.5	 249	92
6	 245	10	 250	90
7	 173	10	 251	85

Table 8 Selective deprotection of primary TBS ethers (0.1 M) with NaIO₄ (6.0 eq.) in THF/H₂O (4:1).

After successful removal of TBS group, we have further investigated. TBDPS and TES groups are also extensively used protecting groups for alcohols and orthogonal to TBS group. Under NaIO₄ in THF/H₂O conditions the primary allylic TBDPS ether is stable and not deprotected (Scheme 73).



Scheme 73 Unsuccessful deprotection of TBDPS ether.

On the contrary, the TES ethers were deprotected under these conditions as shown in Table 9. However, this mild cleavage method should enable applications to sensitive, acid- or base-labile or polyfunctional TES protected substrates (Entry 3, 4, 5). Entry 5 indicated also that primary TBDPS ethers were not deprotected under NaIO₄ in THF/H₂O conditions.

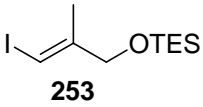
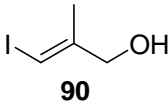
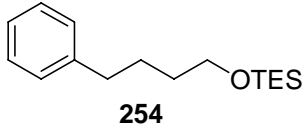
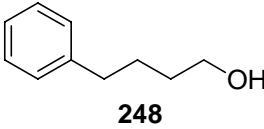
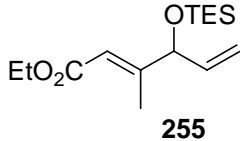
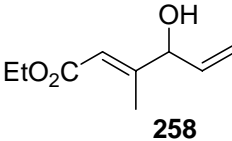
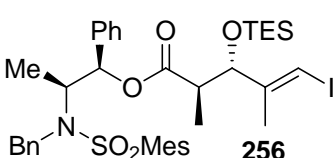
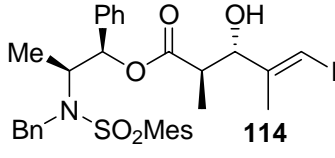
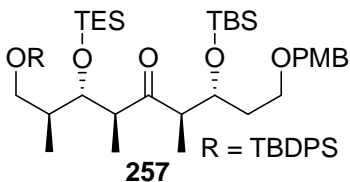
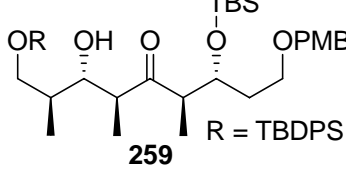
Entry	Substrate	T (h)	Product	Yield (%)
1		1		91
2		1		92
3		1		92
4		18		91
5		10		86

Table 9 Deprotection of TES ethers (0.1 M) with NaIO₄ (6.0 eq.) in THF/H₂O (4:1).

5.3 Conclusion

In summary, we have discovered a new, selective method to deprotect silyl ethers. These mild nonacidic and -basic conditions should enable applications to acid- or base-sensitive or complex substrates. Under these conditions, (1) primary TBS ethers were selectively deprotected in presence of secondary TBS ethers; (2) primary and secondary TES ethers were deprotected; (3) TBDPS ethers were stable; furthermore, (4) primary TBS ethers should be selectively deprotected in presence of primary TBDPS ethers; (5) secondary TES ethers should be selectively deprotected in presence of secondary TBS or TBDPS ethers.

5.4 Preparation of Silyl Ethers

As shown in Table 10, TBS (**241**, **243**, **242**), TBDPS (**252**) and TES (**253**, **254**, **256**, **257**) ethers were prepared under standard conditions.

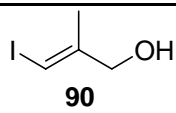
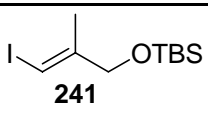
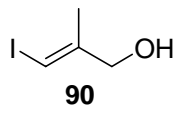
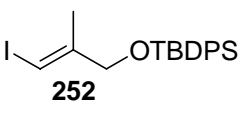
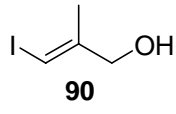
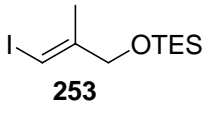
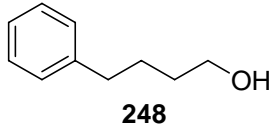
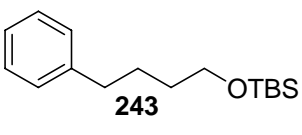
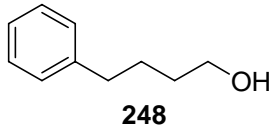
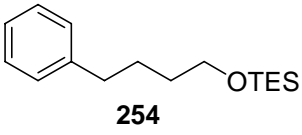
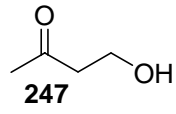
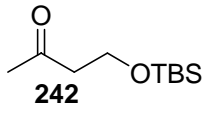
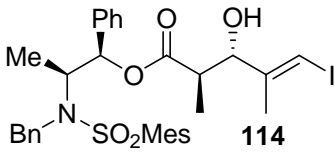
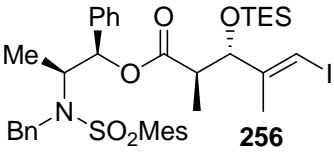
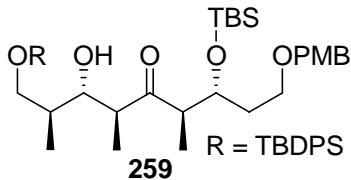
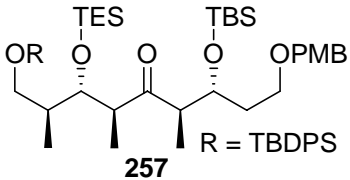
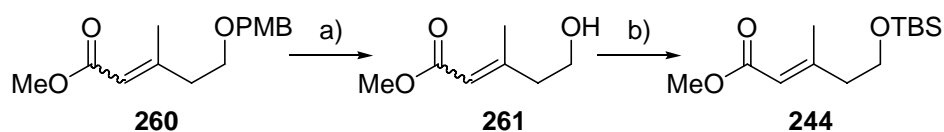
Entry	Substrate	Conditions	Product	Yield (%)
1	 90	a	 241	91
2	 90	b	 252	94
3	 90	c	 253	99
4	 248	a	 243	99
5	 248	b	 254	98
6	 247	a	 242	93
7	 114	d	 256	95
8	 259 R = TBDPS	c	 257 R = TBDPS	93

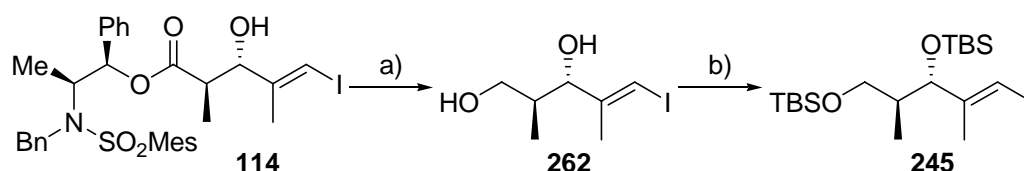
Table 10 (a) TBSOTf, 2,6-lutidine., DCM, -78 °C (b) TBDPSCl, imidazole, DCM, RT; (c) TESOTf, 2,6-lutidine, DCM, -78 °C; (d) TESCl, pyridine, DCM, RT.

TBS ether **244** was synthesized by cleavage of PMB ether **260** followed by TBS protection using TBSOTf and 2,6-lutidine as base at -78 °C (Scheme 74).



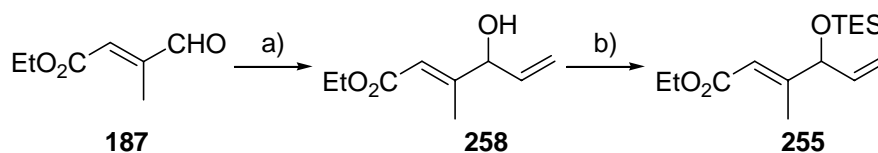
Scheme 74 (a) DDQ, DCM/buffer pH7, (10:1), RT, 80%; (b) TBSOTf, 2,6-lutidine, DCM, -78 °C, 90%.

Treatment of aldol product **114** with BH₃:SMe₂ in THF at -20 °C afforded diol **262** in 78% yield, followed by diprotection of the diol **262** with TBSOTf and 2,6-lutidine in CH₂Cl₂ to give TBS ether **245** in high yield (Scheme 75).



Scheme 75 (a) BH₃:SMe₂, THF, -20 °C, 78%, (b) TBSOTf, 2,6-lutidine, DCM, -78 °C, 90%.

The *Grignard* reaction of aldehyde **187** with vinylMgBr provided secondary alcohol **258**,²⁰⁵ which was converted to TES ether **255** by employing TESOTf and 2,6-lutidine in CH₂Cl₂.



Scheme 76 (a) vinylMgBr, THF, -20 °C, 87%, (b) TESOTf, 2,6-lutidine, DCM, -78 °C, 92%

6 Direct Reductive Amination

Efficient One-Pot Synthesis of Hindered Tertiary Amines with Biological Activity

6.1 Introduction

The direct reductive amination of carbonyl groups, in which a mixture of a carbonyl compound and an amine is treated with a reductant in a “one-pot” fashion, is one of the most useful methods for the preparation of secondary or tertiary amines.²⁰⁶⁻²⁰⁷ But application of these protocols to sensitive, acid-labile or polyfunctional substrates is limited.

Living organisms employ organic NADH (nicotinamide adenine dinucleotide **264**, Figure 21) in combination with enzyme catalysts for the direct reductive amination of ketones.²⁰⁸ A salient feature of this mediated amination is the activation of the imine **262** nitrogen by hydrogen bonds (Figure 21). To mimic key features of this biosynthetic pathway, assembly **265/266** was selected as a surrogate. Thus, in a similar fashion, The “*Hantzsch* ester” **265** would act as a reducing agent by hydride transfer and the imine **266** should be activated by intermolecular hydrogen bonding (Figure 21).

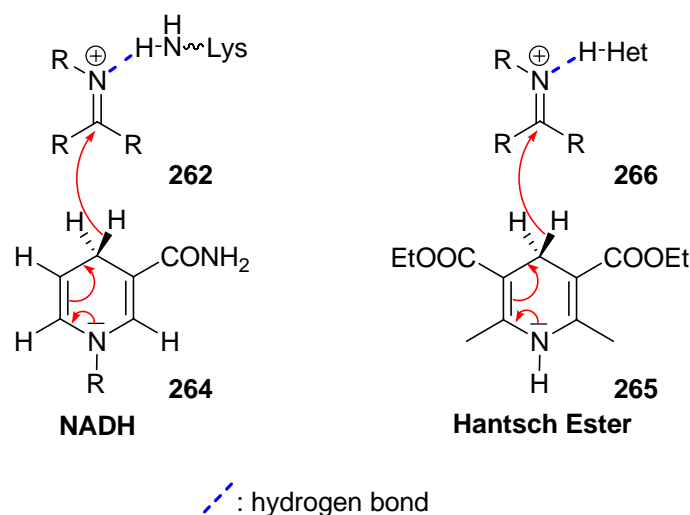
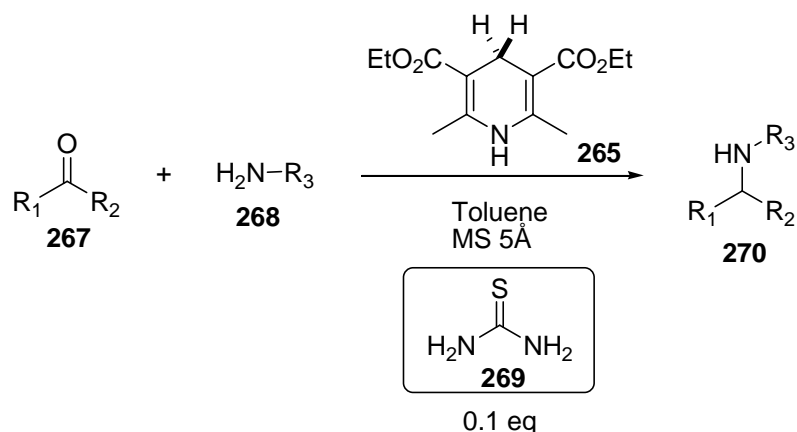


Figure 21 Activation of the imine nitrogen by hydrogen bonds.

Based on this innovative biomimetic approach, a direct reductive amination of ketones and aldehydes was recently developed in our group.²⁰⁹ This method uses the *Hantzsch* ester for transfer hydrogenation and proceeds in the presence of molecular sieves and catalytic amounts of thiourea for imine activation (Scheme 77). With this mild, acid- and metal-free procedure, various secondary amines were synthesized.



Scheme 77 Direct reductive amination of ketones and aldehydes with thiourea as catalyst.

The proposed mechanism was showed in Figure 22. The first steps should involve an equilibrium of ketone **267** and amine **268** with ketimine **271**, which might be rate determining. Imine **271** is not reduced under the reaction conditions. It is only after hydrogen bond activation by thiourea (**269**) to give intermediate **272** that the C=N moiety may be hydrogenated by the *Hantzsch* ester (**265**) to produce amine adduct **274**. For the catalytic cycle to proceed, a transfer of thiourea from **274** to **271** is required to give again complex **262** with concomitant liberation of the product amine **270**.

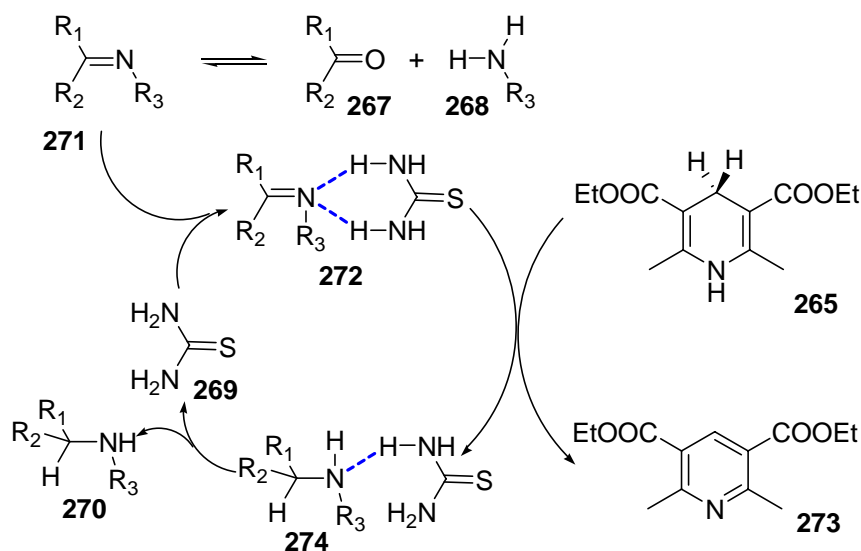


Figure 22 Proposed mechanism of the hydrogen bond catalyzed direct reductive amination.

Tertiary amines are key structural elements in synthetic reagents, for example, in metal mediated asymmetric catalysis as ligand **275**,²¹⁰ and numerous biologically active natural products like cocaine **276**²¹¹ and pharmaceuticals like the clinically used antibiotic ciprofloxacin (**277**) (Figure 23).²¹²

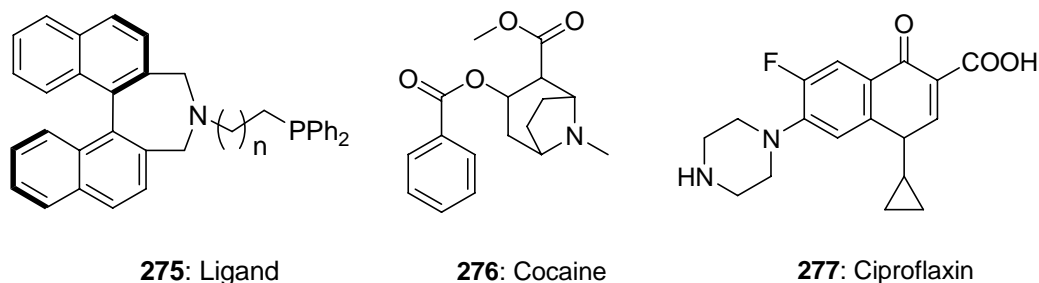


Figure 23 Examples of tertiary amines with biological activity.

Tertiary amines of type **278** in general (Figure 24) could be theoretical accessed in a one-pot process with three components by using the reductive amination of carbonyls. Herein, three types of direct reductive amination procedure for the synthesis of sterically demanding tertiary amines under mild and operationally simple conditions are discussed.

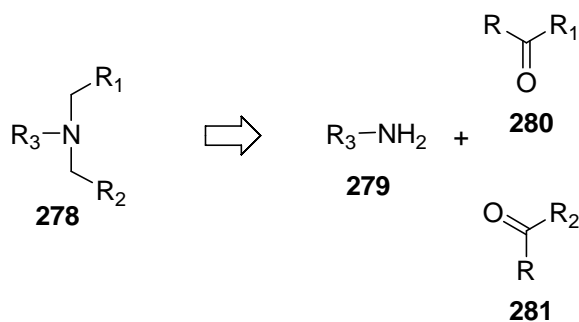
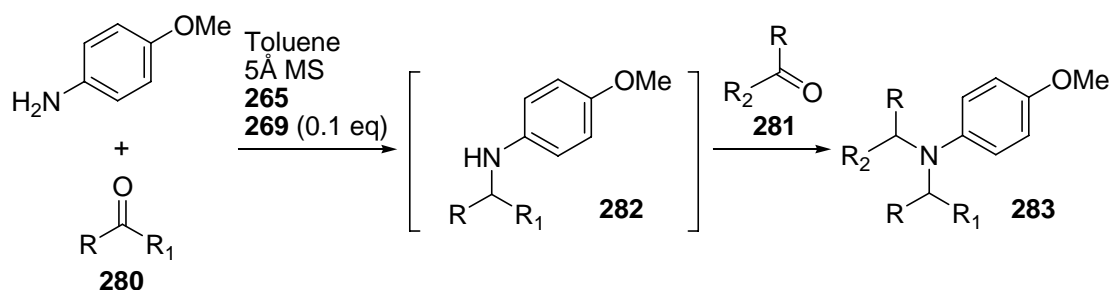


Figure 24 One pot synthesis of tertiary amines.

6.2 One-Pot Synthesis of Hindered Tertiary Amines²¹³

6.2.1 Dialkylation of Amines with Ketone and Aldehyde

As a first target we studied the access to *para*-anisidine by the reaction with ketone and aldehyde. A reaction mixture of *para*-anisidine **279-a** (1.0 mmol), ketone (1.0 mmol) or aldehyde (1.0 mmol), *Hantsch* ester **265** (1.5 mmol), catalytic amounts of thiourea **269** (0.1 mmol) and 5 Å molecular sieves in toluene was stirred at 60 °C. After 24 h, a second equivalent of ketone (1.0 mmol) or aldehyde (1.0 mmol), *Hantsch* ester **265** (1.5 mmol) and thiourea **269** (0.1 mmol) was added. The resulting mixture was stirred at the same temperature for 24-72 h.



Scheme 78 Dialkylation of amine with ketone and aldehyde.

The results (Table 11) showed that the reaction with two ketones (Entry 1) gave only the secondary amine (GCMS) and no desired tertiary amine **283-a**. The reaction with acetophenone and isobutyraldehyde provided the desired tertiary amine **283-a** in moderate yield (Entry 2). The best result was achieved with two aldehydes (Entry 3). Based on these results, the amination of two aldehydes with *para*-anisidine and the amination of two aldehydes with different amines were studied.

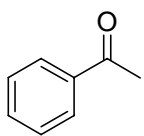
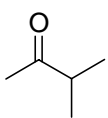
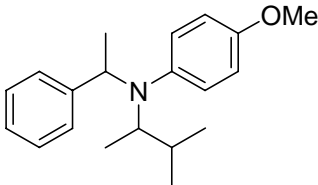
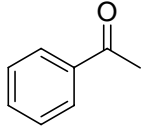
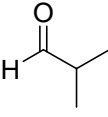
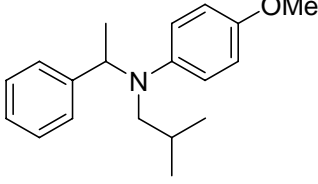
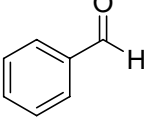
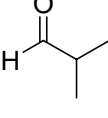
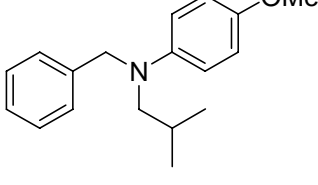
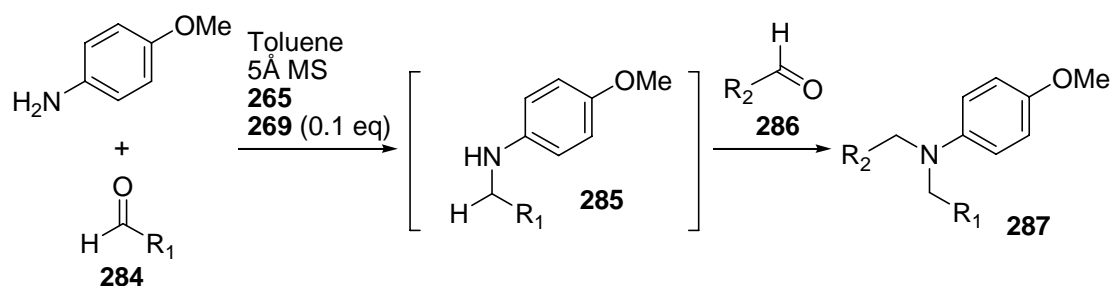
Entry	Carbonyl 280	Carbonyl 281	Product 283 (a-c)	Yield (%)
1				0
2				56
3				67

Table 11 Results of dialkylation of amine with ketone and aldehyde.

6.2.2 Dialkylation of *para*-Anisidine with two Aldehydes

Treatment of *para*-anisidine (1.0 mmol), a first aldehyde **284** (1.0 mmol), *Hantzsch* ester **265** (1.5 mmol), and 5 Å molecular sieves with catalytic amounts of thiourea **269** (0.1 mmol) in toluene at 60 °C for 24 h produced a secondary amines as intermediate which was then treated with a second aldehyde **286** (1.0 mmol), *Hantzsch* ester **265** (1.5 mmol) and thiourea **269** (0.1 mmol) at the same temperature for 24 h.

Scheme 79 Dialkylation of *para*-anisidine with two aldehydes.

Indeed, this procedure was successful. Table 12 showed the results of this procedure. Mostly, the desired trisubstituted amines **287** were obtained in good yield (Entries 1-5). Both aliphatic and aromatic aldehydes were accepted as substrates and variations in the electronic and steric properties were tolerated.

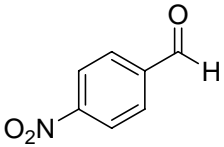
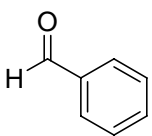
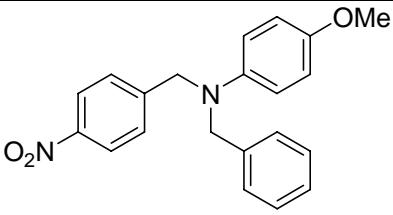
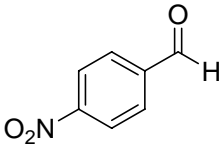
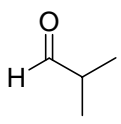
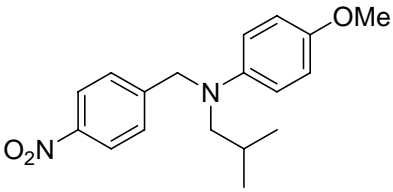
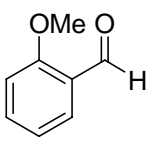
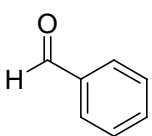
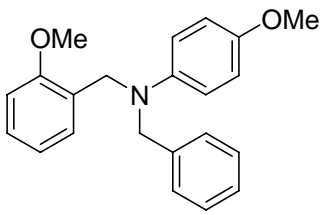
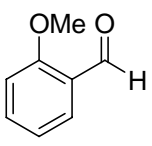
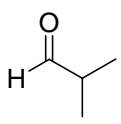
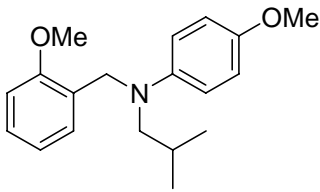
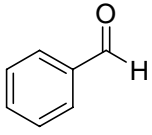
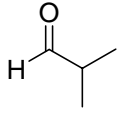
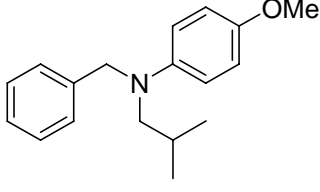
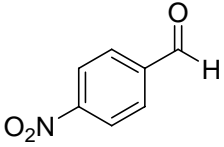
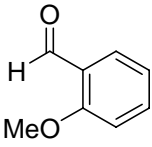
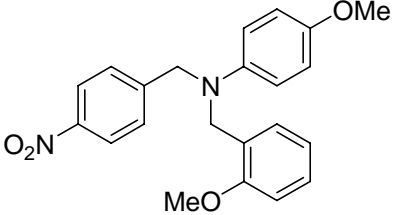
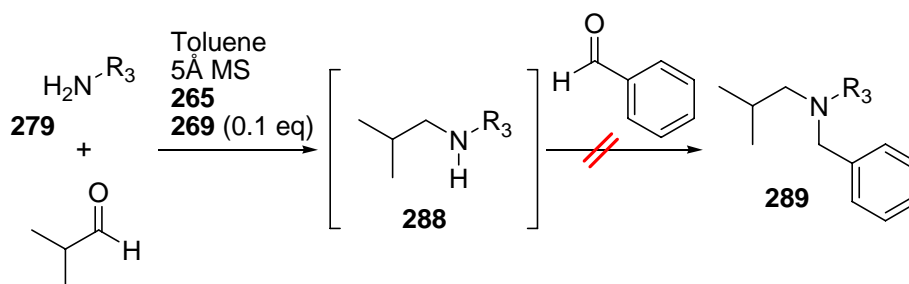
Entry	Carbonyl 284	Carbonyl 286	Product 287 (a-f)	Yield (%)
1				86
2				82
3				79
4				75
5				67
6				30

Table 12 Results of dialkylation of *para*-anisidine with two aldehydes.

The amination with 4-nitrobenzaldehyde and 2-methoxybenzaldehyde (Entry 6) provided the tertiary amine **287-f** in poor yield. This could be explained by steric aspect because the product **287-f** was more hindered.

6.2.3 Dialkylation of Different Amines with Isobutyraldehyde and Benzaldehyde

In order to study the dialkylation of different amines with isobutyraldehyde and benzaldehyde, a suspension of isobutyraldehyde (1.0 mmol), *Hantzsch* ester **265** (1.5 mmol), catalytic amounts of thiourea **269** (0.1 mmol) and 5 Å molecular sieves in toluene were treated with amine **279** (**b-f**) at 60 °C for 24 h. Benzaldehyde (1.0 mmol), *Hantzsch* ester **265** (1.5 mmol) and thiourea **269** (0.1 mmol) were added. The mixture was stirred at the same temperature for another 24 h.



Scheme 80 Dialkylation of different amines with isobutyraldehyde and benzaldehyde.

As shown in Table 13, this procedure was not successful and no desired tertiary amines were obtained. GC-MS analysis showed that the reaction stops after the first step. A further amination with benzaldehyde did not occur.

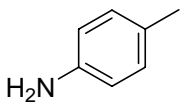
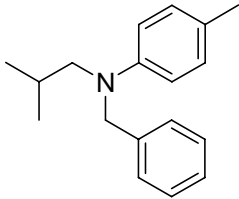
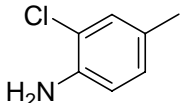
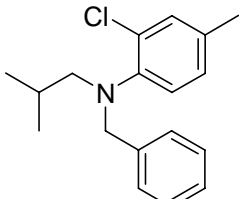
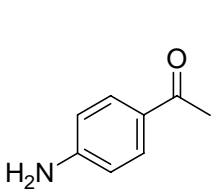
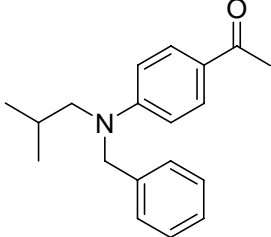
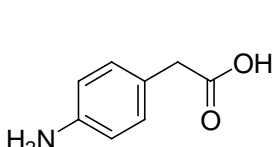
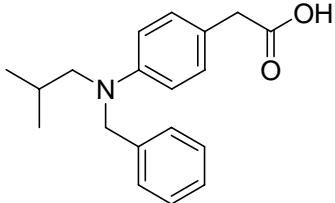
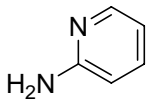
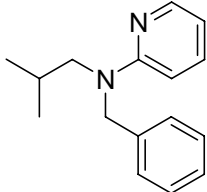
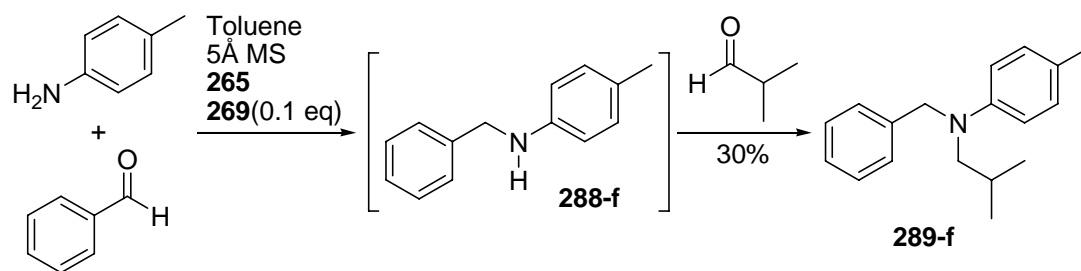
Entry	Amine 279	Product 289 (a-e)	Yield (%)
1			0
2			0
3			0
4			0
5			0

Table 13 Unsuccessful dialkylation of different amines with isobutyraldehyde and benzaldehyde.

To our surprise, if the order of isobutyraldehyde and benzaldehyde (Table 13, Entry 1) was changed, the desired tertiary amine **289-f** was obtained (Scheme 81). This could be explained by following aspects:

- 1) *para*-anisidine is more electrophilic than *para*-toluidine;
- 2) isobutyraldehyde is more nucleophilic than benzaldehyde;
- 3) the second amination is more difficult than the first one (also due to steric aspect).



Scheme 81 Dialkylation of *para*-toluidine with isobutyraldehyde and benzaldehyde.

6.3 Biological activity

In view of the cytotoxic activity of simple aromatic amines,²¹⁴ it appeared rewarding to likewise test these tertiary amines in whole cell-based assays. Consequently, the inhibitory effect on the murine connective tissue cell line L-929 was analyzed.²¹⁵ As shown in Table 14, various representatives showed potent cytotoxicity with IC₅₀ values in the low micromolar range. These results demonstrate that the biological function of such tertiary amines is quite versatile.

To get further hints about the mode of action, the tertiary amine **289-f** and the secondary amine **290** as exemplary representatives of this compound class were checked for effects on the morphology of PtK2 porroo cells by *Florenz Sasse* at our Institute. The cultured cells were stained by labeling the nuclei and a marker protein of the endoplasmatic reticulum, and inspected by fluorescence microscopy. As shown in Figure 25, treated cells showed striking alterations of the inner membrane structure of the cytoplasm. They displayed big vacuoles near the nucleus or a cushion-like pattern, the first being more pronounced in the **290** treated cells. Compound **289-f** seems to be less effective in vacuolization, rather leading to cell enlargement. The effect of **290** is very similar to the corallidicyals, sesquiterpene hydroquinones from the Caribbean Sponge *Aka coralliphagum*,²¹⁶ which suggests that a similar mode of action might be involved. Possibly, redox processes might be associated. The notion that the tertiary amine **289-f** is less effective in vacuolization as compared to **290**, might be related to the fact that the central nitrogen is sterically much more hindered and thus less accessible to oxidation–reduction processes. Significantly, tertiary amines are more potent in the cell culture assays in comparison to primary or secondary amines, which might suggest that also other effects may be involved for these more encumbered nitrogen-containing structures.

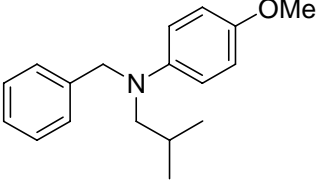
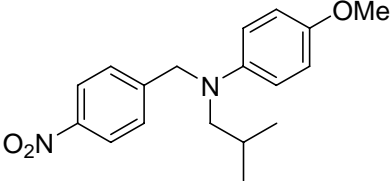
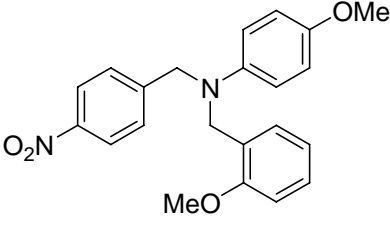
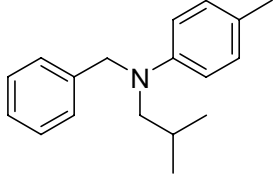
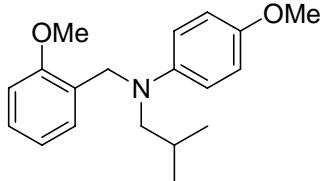
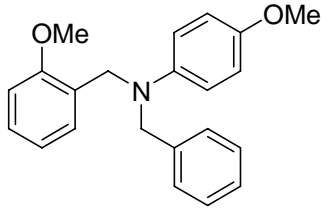
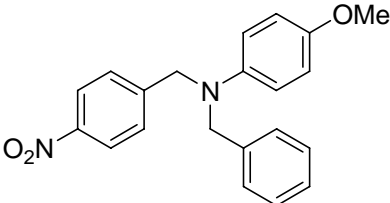
Compound	Growth inhibition L-929 IC ₅₀ μg/mL (μM)
	10 (37)
	> 40
	> 40
	5 (20)
	15 (50)
	> 40
	> 40

Table 14 Inhibitory effects of tertiary aromatic amines on the growth of mammalian murine connective tissue cell line.

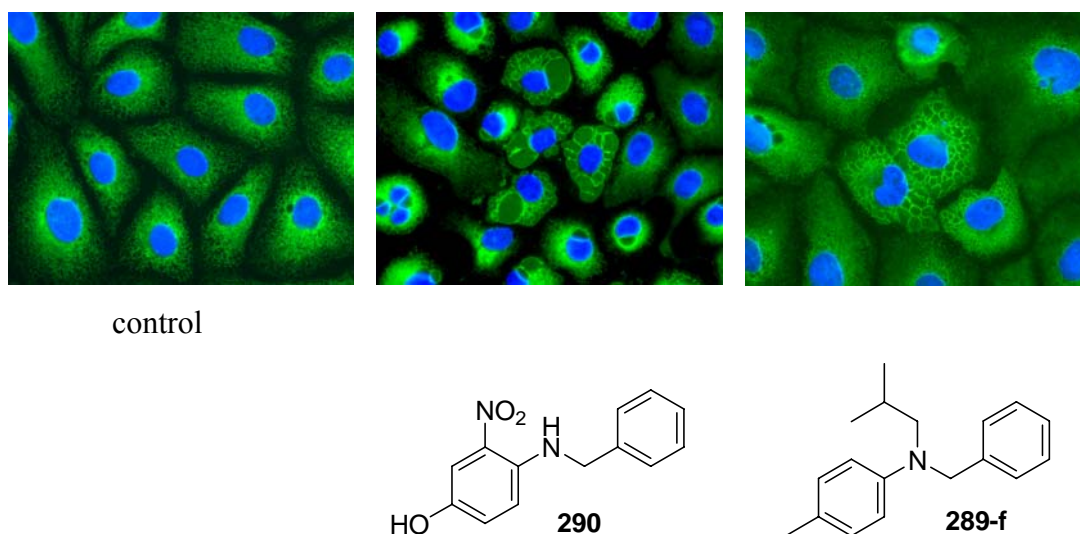


Figure 25 Changes in the morphology of cultivated PtK2 potoroo cells upon treatment with the tertiary amine **289-f** (right side) and the secondary amine **290** (middle) in comparison to control cells (left side). Cells were incubated with 50 $\mu\text{g/mL}$ for 18 h and stained for nuclei (blue) and ER structure (green).

6.4 Conclusion

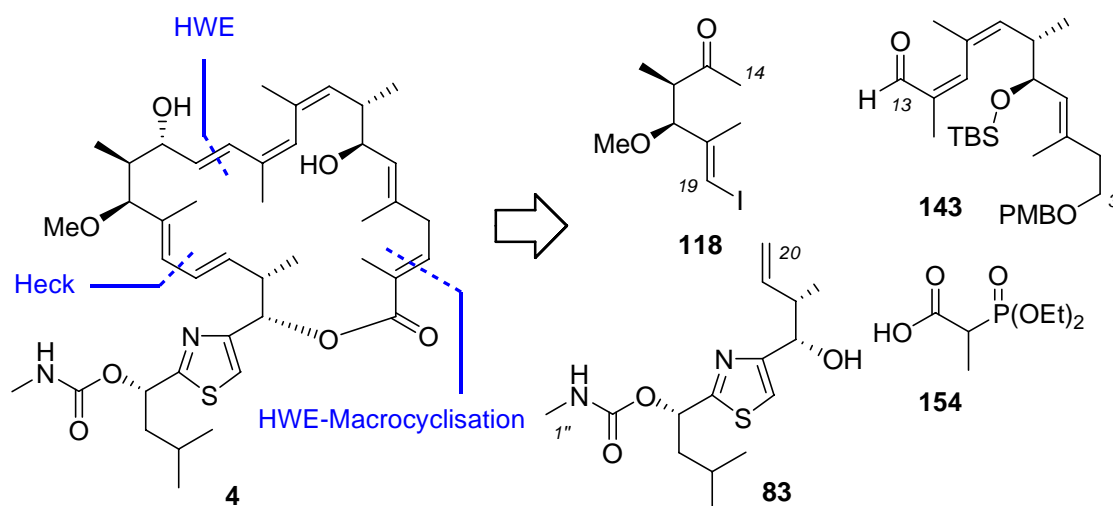
We have developed an efficient procedure for the synthesis of structurally diverse tertiary amines, including aromatic and sterically demanding amines. The operationally simple procedure uses the *Hantzsch* ester for transfer hydrogenation and proceeds in the presence of molecular sieves and thiourea. The mild conditions and chemoselectivity of this protocol should enable applications also to complex and/or acid-sensitive substrates. It is expected, that this method opens the venue for further exploring sterically hindered tertiary amines as synthons for preparative and medicinal chemistry.

Indeed, these tertiary amines exhibited pronounced inhibitory effects on the growth of the murine connective tissue cell line L-929 in the low micromolar range. Two exemplary was shown to cause alterations of the inner membrane structure of the cytoplasm by microscopy-based studies.

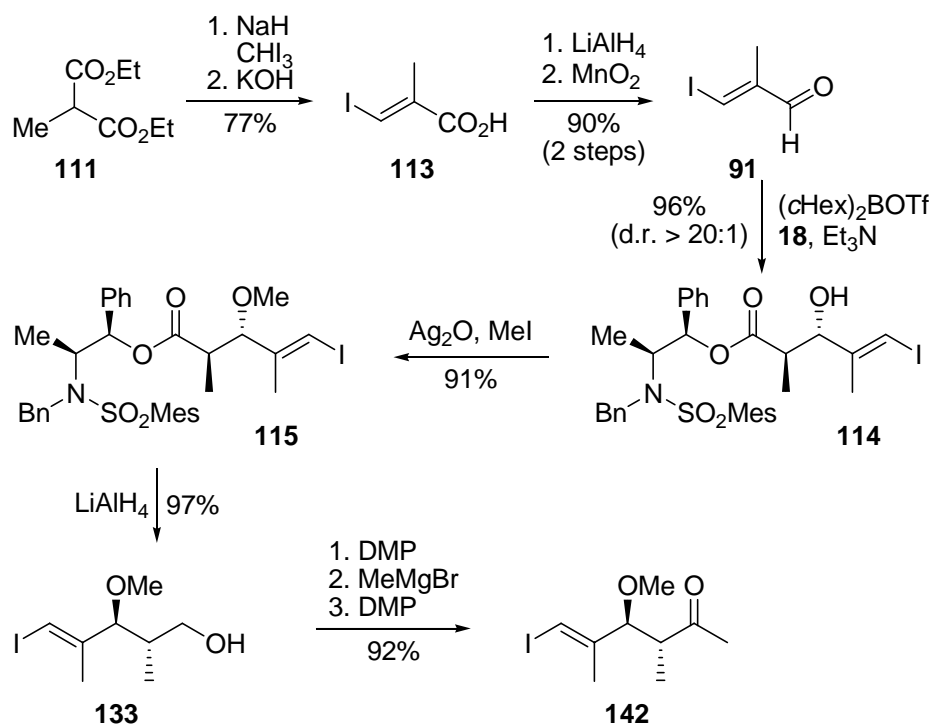
7 Summary

7.1 Total Synthesis of Archazolid A

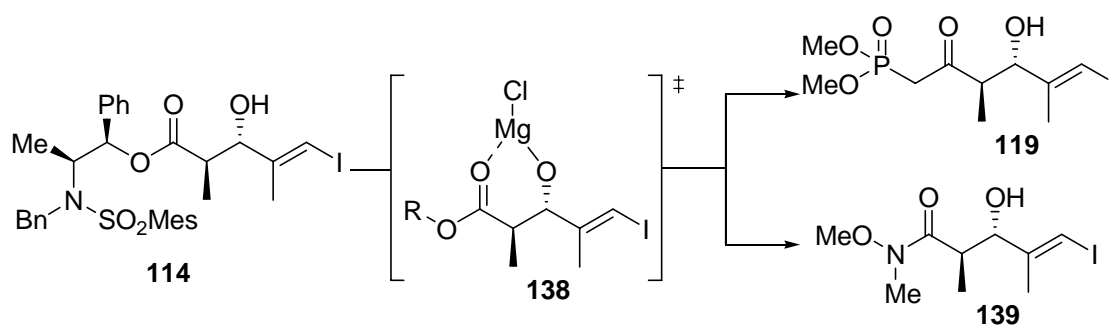
Archazolid A (**4**) is a potent V-ATPase inhibitor from the myxobacterium *Archangium gephzra*. An expedient first total synthesis of archazolid A could be accomplished by coupling of the three main building blocks (**143**, **118**, **83**). The total synthesis of archazolid A proceeds in 20 steps and 4% overall yield from **60** (longest linear sequence) and establishes unequivocally the relative and absolute configuration.



Firstly, this thesis describes the synthesis of the C14-C19 subunit **118**. This was accomplished in 10 steps with 54% overall yield in a well-scalable route providing several grams of the required building block. Key features of the synthesis include an optimized procedure to prepare the vinyl iodide **113** and a highly enantio- and diastereoselective *Abiko-Masamune* anti aldol reaction to construction C16 and C17 stereocentres.



Additionally, an efficient method for the direct displacement of the *Abiko-Masamune* auxiliary by using metallated phosphonates and *Weinreb* amides was developed which uses $i\text{PrMgCl}$ for carbonyl activation. The resulting intermediates, such as β -ketone phosphonate **119** and *Weinreb* amide **139** are generally very useful in the total synthesis of natural products.

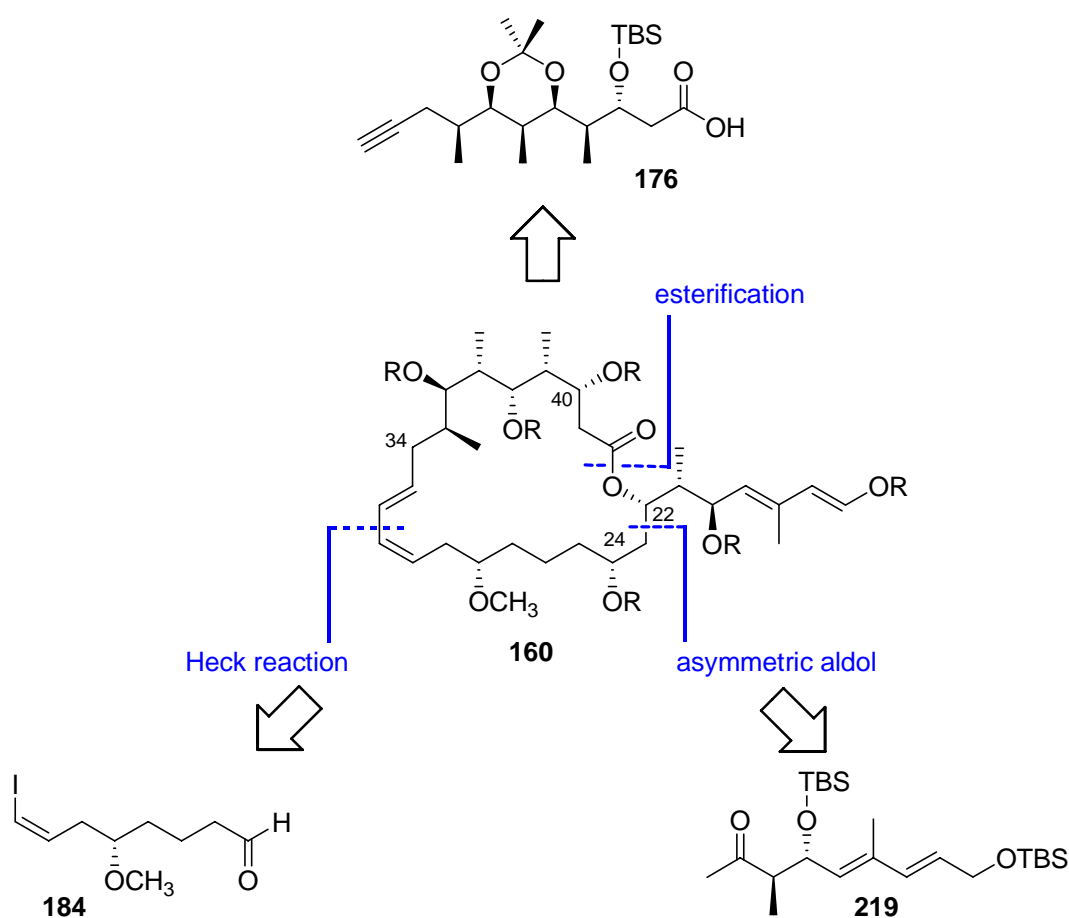


Finally, for completion of the total synthesis, fragment **118** was connected with **143** by using an aldol condensation reaction, followed by a highly advantageous *Heck*-coupling and subsequent *HWE* macrocyclisation to construct the macroclactone. Alternatively, the macrocyclic core of the archazolids was also constructed by an inter-molecular *HWE* reaction between **143** and **154** and a subsequent *Heck*-macrocyclisation.

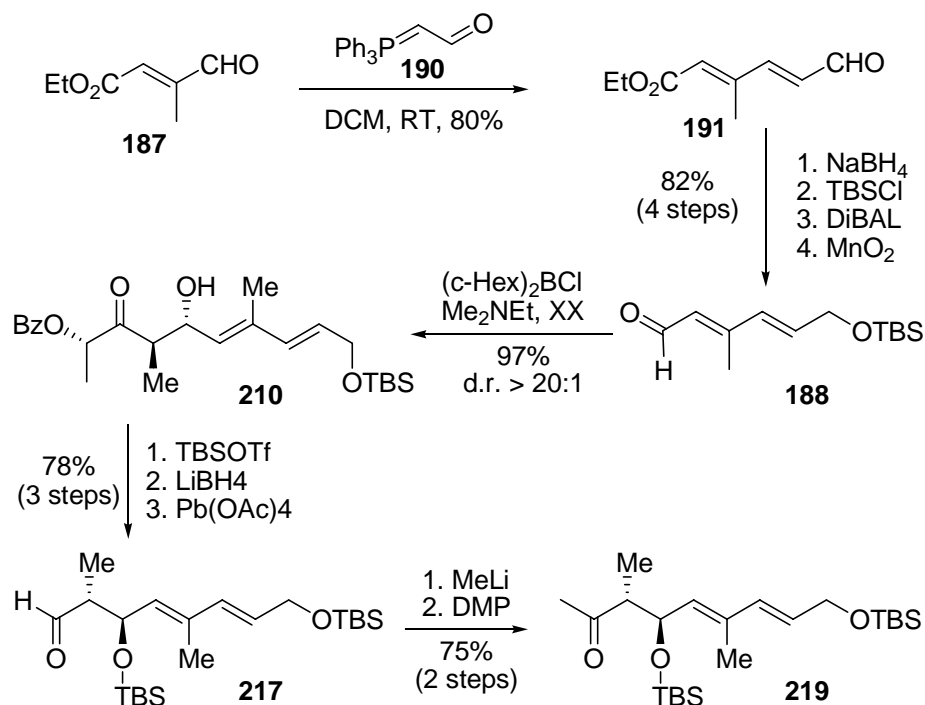
7.2 Studies Towards the Total Synthesis of Etnangien

Etnangien (**14**) is a macrolide isolated from culture broths of various strains of the myxobacterium *Sorangium cellulosum* and shows antibiotic activity against various gram-positive bacteria (IC_{50} : ~100 nM) by inhibition of RNA-polymerase. Notably, it shows no cross-resistance to rifampicin, a clinically-valued RNA-polymerase inhibitor. This thesis describes the synthesis of the C15-C23 subunit and the preparation of the macrocyclic core of etnangien.

The macrocycle **160** of etnangien was successfully synthesized from three main building blocks (**176**, **184**, **219**). For their fusion, a highly asymmetric Ipc-boron-mediated aldol reaction, an efficient *Yamaguchi* esterification and an *E*-selective *Heck* macrocyclization ($Pd(OAc)_2 / K_2CO_3 / Bu_4NCl$ in DMF) were used. In total, this route proceeds in 18 steps and 27% overall yield from **168** (longest linear sequence).



The C15-C23 subunit **219** was synthesized in 11 steps with 37% yield from aldehyde **187** in a well-scalable process providing several grams of the desired building block. Key transformations include a highly enantio- and diastereoselective *Paterson anti*-aldol reaction to install the stereocentre C20/C21, an optimized *Wittig* reaction procedure to prepare the aldehyde **191**, a TBS protection reaction with proton sponge[®] as base and a highly efficient oxidative cleavage of diol **216** with $\text{Pb}(\text{OAc})_4$.



7.3 Selective Deprotection of Silyl Ethers with NaIO_4

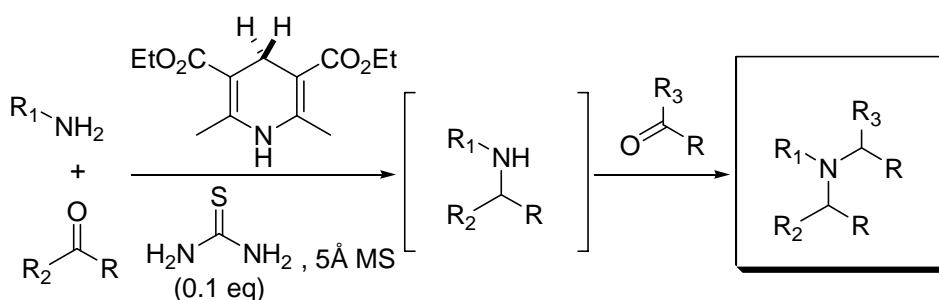
During the course of this thesis, a new and selective method to cleave silyl ethers has been developed. The mild nonacidic and -basic conditions enable applications to acid- or base-sensitive or complex substrates. Under the conditions, which involve the use of NaIO_4 (1) primary TBS ethers were selectively deprotected in presence of secondary TBS ethers; (2) TES ethers were unstable; (3) TBDPS ethers were stable; furthermore, (4) primary TBS/TES ethers may be selectively deprotected in presence of primary TBDPS ethers; (5) secondary TES ethers may be selectively deprotected in presence of secondary TBS/TBDPS ethers.

Notably, this method was successfully used for deprotection of the primary TBS ether of the highly complex substrate **237**, giving **238** with excellent yield.

7.4 Direct Reductive Amination

We have developed an efficient procedure for the synthesis of structurally diverse tertiary amines, including aromatic and sterically demanding amines. The operationally simple procedure uses the *Hantzsch* ester for transfer hydrogenation and proceeds in the presence of molecular sieves and thiourea. The mild conditions and chemoselectivity of this protocol should enable applications also to complex and/or acid-sensitive substrates. It is expected, that this method opens the venue for further exploring sterically hindered tertiary amines as synthons for preparative and medicinal chemistry.

Indeed, these tertiary amines exhibited pronounced inhibitory effects on the growth of the murine connective tissue cell line L-929 in the low micromolar range. Two substances were analysed in more detail and were shown to cause alterations of the inner membrane structure of the cytoplasm.



8 Experimental Section

8.1 General Methods

All non-aqueous reactions were performed using oven-dried (100 °C) or flamedried glassware under a positive pressure of dry argon (Ar) unless otherwise noted.

Tetrahydrofuran and diethyl ether were freshly dried under reflux and an atmosphere of Ar over sodium (Na) and benzophenone as indicator and purified by distillation. Methylene chloride was dried under reflux and an atmosphere of Ar over calciumhydride (CaH₂) and purified by distillation. Other dry solvents were obtained commercially. All reagents were obtained commercially as reagent grade and, unless otherwise noted, used without further purification. The organic extracts were dried over anhydrous magnesium sulfate (MgSO₄) or sodium sulfate (Na₂SO₄). The column chromatographic purifications were performed on silica gel (230-400 mesh).

Analytical TLC: Thin-layer chromatography was performed on precoated silica gel 60 F₂₅₄ (Merck) analytical plates and visualized by fluorescence quenching under UV light. In addition, TLC plates were stained using cerium(IV)sulfate- phosphomolybdic acid in sulfuric acid followed by charring.

Melting points: measured on a Büchi 510 apparatus. All melting points were measured in open capillaries and are uncorrected.

Optical rotations: Optical rotations were measured on a Perkin-Elmer 241 instrument operating at the sodium D line with a 100 mm path length cell, and are reported as follows: $[\alpha]_D^T$, concentration (g/100 ml), and solvent.

NMR spectra: NMR spectra were recorded in CD₃OD and CDCl₃ on a Bruker AM 300, AM 400 and DMX-600 spectrometer. Chemical shifts are reported in parts per million (ppm, δ) with the residual non-deuterated solvent as an internal standard. In reporting spectral data, the following abbreviations were used: s = singlet, d = doublet, t = triplet, q = quartet, quin = quintuplet, m = multiplet, dd = doublet doublet, dt = doublet triplet.

Mass spectra: EI and DCI mass spectra (reactant gas ammonia) were obtained on a Finnigan MAT 95 spectrometer, high resolution data were acquired using peak matching (M/DM = 10000).

Chemical names: generated with ChemOffice 2005 (CambridgeSoft[®]).

8.2 Preparation of Reagents

A Stock Solution of Dicyclohexylboron Triflate [(C₆H₁₁)₂BOTf] in Hexane

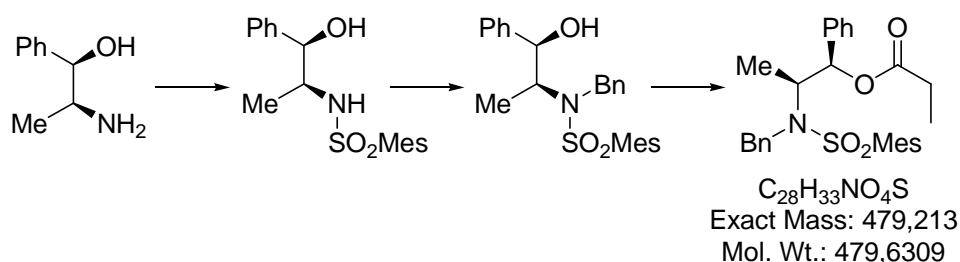
An oven-dried 250-mL round-bottom flask capped with a rubber septum was charged with cyclohexene (14.2 mL, 140 mmol) and dry diethyl ether (50 mL), and kept at 0 °C under argon. Borane-dimethyl sulfide complex (6.64 mL, 70.0 mmol) was added dropwise during 30 min with stirring, and then the whole reaction mixture was stirred for 3 h at 0 °C, when the solid was settled without stirring. The supernatant organic solution was removed as much as possible by syringe, and the residual solid was washed with dry diethyl ether (2 × 50 mL) and dried *in vacuo* to give dicyclohexylborane (11.3 g, 63.4 mmol), which was used for the preparation of the triflate without further purification. The solid was suspended in 50 mL of dry *n*-hexane and trifluoromethanesulfonic acid (10.0 g, 66.6 mmol) was added dropwise via syringe during 30 min with constant stirring, during which time vigorous gas evolution occurred and the solid gradually disappeared. Stirring continued at room temperature for 1 h. The solvent was reduced to ca. 5 mL and removed by syringe. The residual solid was washed with dry diethyl ether (3 × 5 mL) and dried *in vacuo* to give dicyclohexylboron triflate (16.6 g, 50.9 mmol), which was dissolved in 45 mL dry *n*-hexane (ca. 1M).¹

Dicyclohexylboron Chloride [(C₆H₁₁)₂BCl]

To a solution of dried cyclohexene (21.2 mL, 210 mmol) in anhydrous diethyl ether (90 mL) under an argon atmosphere at 0 °C was slowly added monochloroborane dimethyl sulphide (11.6, mL, 100 mmol). The mixture was stirred at 0 °C for 2 h and then the solvent was removed by distillation. The resulting crude product was distilled under reduced pressure (104-105 °C / 0.5 mmHg) to afford the dicyclohexylboron chloride as a colorless oil.²

¹ Inoue, T.; Liu, J.-F.; Buske, D. C.; Abiko, A. *J. Org. Chem.* **2002**, *67*, 5250-5256.

² Cowden, C, J.; Paterson, I. *Org. React.* **1997**, *51*, 1.

(1*R*,2*S*)-2-(*N*-benzyl-2,4,6-trimethylphenylsulfonamido)-1-phenylpropyl propionate 18

To a stirred solution of (-)-Norephedrin (5.22 g, 34.5 mmol, 1 eq) and Et_3N (5.77 ml, 41.4 mmol, 1.2 eq) in CH_2Cl_2 (60 mL) was added mesitylenesulfonyl chloride (7.55 g, 34.5 mmol, 1 eq) at 0 °C. The reaction mixture was stirred at 0 °C for 2 h and diluted with Et_2O (120 mL). The mixture was washed with 20 ml each of H_2O , 1 M aqueous HCl, H_2O , saturated aqueous Na_2CO_3 and saturated aqueous NaCl and dried over Na_2SO_4 . The organic solution was concentrated to give an oily residue, which was dissolved in CH_2Cl_2 (8 mL). Hexane (16 mL) was added in the solution to give the crystalline (11.5 g, 34.5 mmol, 100%).

mp 120 °C; $[\alpha]_D^{20} = -15.5$ ($c = 1.06$, $CHCl_3$); 1H -NMR (300 MHz, $CDCl_3$) δ ppm 0.85 (d, $J=7.0$ Hz, 3 H), 2.29 (s, 3 H), 2.64 (s, 6 H), 2.68 (s, 1 H), 3.44 - 3.55 (m, 1 H), 4.76 (d, $J=3.0$ Hz, 1 H), 4.98 (d, $J=8.5$ Hz, 1 H), 6.94 (s, 2 H), 7.20 - 7.32 (m, 5 H); ^{13}C -NMR (75 MHz, $CDCl_3$) δ ppm 14.6, 20.9, 23.0, 54.7, 75.7, 126.0, 127.7, 128.4, 132.0, 134.4, 139.0, 140.4, 142.3.

To a stirred solution of *N*-((1*R*,2*S*)-1-hydroxy-1-phenylpropan-2-yl)-2,4,6-trimethyl benzenesulfonamide (4.20 g, 12.6 mmol, 1 eq) in DMF (50 mL) was added *t*-BuOK (1.41 g, 12.6 mmol, 1 eq) at room temperature. After 20 min, benzyl bromide (1.50 mL, 12.6 mmol, 1 eq) was added. The reaction mixture was stirred at room temperature for 3 h and water (170 mL) was added. The mixture was extracted with CH_2Cl_2 (5x50 mL). The combined organic layers were dried over Na_2SO_4 and concentrated in vacuum. The residue was purified by column chromatography on silica gel (hexanes / EtOAc = 4:1) to give the alcohol (5.07 g, 12.0 mmol, 95%) as a white solid.

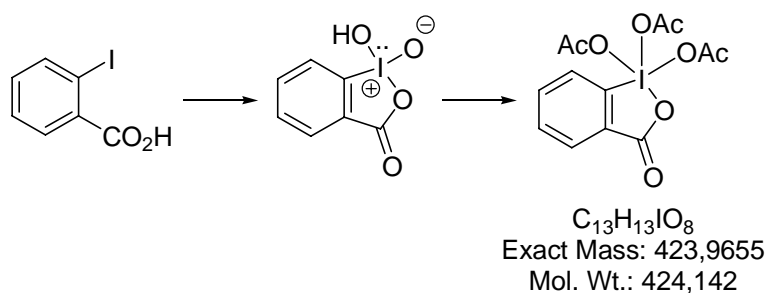
$R_f = 0.47$ (hexanes / EtOAc = 4:1); m.p. 125 °C; $[\alpha]_D^{20} = -7.9$ ($c = 0.81$, $CHCl_3$); 1H -NMR (300 MHz, $CDCl_3$) ppm 1.03 (d, $J=7.0$ Hz, 3H), 2.16 (d, $J=2.8$ Hz, 1H), 2.28 (s, 3H), 2.64 (s, 6H), 3.84 (dq, $J=1.9$ Hz, $J=5.3$ Hz, 1H), 4.55 (A of ABq, $J_{AB}=16.0$, 1H), 4.77 (B of ABq, $J_{AB}=16.2$, 1H), 4.99 (s, 1H), 6.93 (s, 2H), 7.03 - 7.10 (m, 2H), 7.15 - 7.36 (m, 8H); ^{13}C -NMR

(75 MHz, CDCl₃) δ ppm 10.0, 20.9, 23.0, 49.2, 59.8, 76.7, 125.6, 127.3, 127.4, 127.8, 128.2, 128.6, 132.2, 133.6, 138.7, 140.2, 142.2, 142.6.

To a solution of *N*-benzyl-*N*-((1*R*,2*S*)-1-hydroxy-1-phenylpropan-2-yl)-2,4,6-trimethyl benzenesulfonamide (4.56 g, 10.8 mmol, 1 eq) and pyridine (1.13 mL, 14.0 mmol, 1.3 eq) in CH₂Cl₂ (60 mL) was added propionyl chloride (1.14 mL, 13.0 mmol, 1.2 eq) at 0 °C. The reaction was stirred at room temperature for 15 h and diluted with diethyl ether (100 mL). The mixture was washed with 30 mL each of water, 1 M HCl, water, saturated aqueous Na₂CO₃ and saturated aqueous NaCl and dried over Na₂SO₄. The organic solution was concentrated to give a crystalline, which was purified by column chromatography on silica gel (hexanes / EtOAc = 10:1) to give the ester (5.16 g, 10.8 mmol, ~100%) as a white solid.

R_f = 0.31 (hexanes / EtOAc = 10:1); m.p. 143 °C; $[\alpha]_D^{20}$ = +9.0 (c = 1.10, CHCl₃); ¹H-NMR (300 MHz, CDCl₃) ppm 1.02 (t, J = 7.5 Hz, 3H), 1.13 (d, J = 7.0 Hz, 3H), 2.14 (m, 2H), 2.27 (s, 3H), 2.52 (s, 6H), 4.06 (dq, J = 4.1, 6.9 Hz, 1H), 4.60 (A of ABq, J_{AB} = 16.8, 1H), 4.72 (B of ABq, J_{AB} = 16.6, 1H), 5.85 (d, J = 4.0 Hz, 1H), 6.87 (s, 2H), 6.90-6.94 (m, 2H), 7.14-7.34 (m, 8H); ¹³C-NMR (75 MHz, CDCl₃) δ ppm 8.8, 12.8, 20.9, 23.0, 27.5, 48.2, 56.8, 78.0, 126.0, 127.1, 127.4, 127.8, 128.4, 132.2, 133.5, 138.7, 140.2, 142.5, 172.6; HRMS calculated for C₃₀H₃₆N₂O₄SNa [M+CH₃CN+Na]⁺: 543.2293, found: 543.2300. The spectroscopic data were in agreement to those previously reported.³

Dess-Martin periodinane 136



2-Iodobenzoic acid (100 g, 0.403 mol, 1.0 eq.) was added to a suspension of Oxone (362 g, 0.589 mol, 1.4 eq.) in water (1.3 L) in a 2 L flask. The reaction mixture was warmed to 70 °C and stirred at this temperature for 3 h. The suspension was then cooled to 5 °C and left at this temperature for 2 h with slow stirring. The mixture was filtered through a medium porosity sintered-glass funnel, and the solid was repeatedly rinsed with water (7 × 150 mL) and

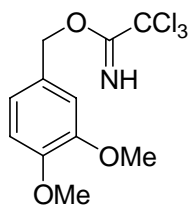
³ Inoue, T.; Liu, J.-F.; Buske, D. C.; Abiko, A. *J. Org. Chem.* **2002**, *67*, 5250-5256.

acetone (2 × 150 mL). The white, crystalline solid was left to dry at rt for 16 h and weighed 98.7 g (87%).⁴

l-Hydroxy-1,2-benziodoxol-3(*H*)-one (98.7 g, 0.352 mol, 1.0 eq.) was added to a 1 L flask containing Ac₂O (399 mL, 4.22 mol, 12 eq.) and TsOH·H₂O (536 mg, 2.82 mmol, .008 eq.). The reaction mixture was warmed to 80 °C and stirred at this temperature for 2 h and then cooled in an ice-water bath. The cold mixture was filtered through a fritted glass funnel followed by rinsing with anhydrous ether (5 × 50 mL). The resulting white, crystalline solid (127 g, 85%) was dried *in vacuo*.⁵

¹H NMR (300 MHz, CDCl₃) δ = 1.98 (s, 6H), 2.31 (s, 3H), 7.89 (m, 1H), 8.06 (m, 1H), 8.28 (m, 2H); ¹³C NMR (75 MHz, CDCl₃) δ = 20.3, 20.4, 126.0, 126.5, 131.8, 133.8, 135.7, 142.3, 166.1, 174.0, 175.7. The spectroscopic data were in agreement to those previously reported.⁶

3,4-dimethoxybenzyl 2,2,2-trichloroacetimidate 208



C₁₁H₁₂Cl₃NO₃
Exact Mass: 310,9883
Mol. Wt.: 312,5769

A solution of 3,4-dimethoxybenzyl alcohol (5.00 g, 29.7 mmol, 1.0 eq.) in tetrahydrofuran (6.0 mL) was slowly added to a suspension of sodium hydride (60% dispersion in oil) (238 mg, 6.00 mol, 0.2 eq.) in tetrahydrofuran (6.0 mL). The solution was then cooled to 0 °C and trichloroacetonitrile (3.50 mL, 35.0 mmol, 1.2 eq.) was added dropwise. The mixture was stirred for 1 h at 0 °C and 2 h at room temperature. Pentane (10 mL) containing methanol (0.2 mL) was added followed by activated carbon. The mixture was stirred for 1 h before being filtered through celite. The celite was then washed with pentane. The organic phase was concentrated under reduced pressure affording the trichloroacetimidate, which was used without further purification (6.57 g, 21.0 mmol, 71%).

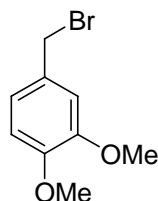
⁴ Frigerio, M.; Santagostino, M.; Sputore, S. *J. Org. Chem.* **1999**, *64*, 4537-4538.

⁵ Ireland, R. E.; Liu, L. *J. Org. Chem.* **1993**, *58*, 2899-2899.

⁶ Dess, D. B.; Martin, J. C. *J. Am. Chem. Soc.* **1991**, *113*, 7277.

$R_f = 0.48$ (hexanes / EtOAc = 6:1); $^1\text{H NMR}$ (300 MHz, CDCl_3) $\delta = 3.87$ (s, 6H), 5.27 (s, 2H), 6.85 (d, $J = 7.9$ Hz, 1H), 6.98 (m, 2H), 8.36 (s, 1H); $^{13}\text{C NMR}$ (75 MHz, CDCl_3) $\delta = 55.9$, 70.8, 111.0, 111.3, 120.7, 127.9, 194.0, 194.1, 162.5. The spectroscopic data were in agreement to those previously reported.⁷

4-(bromomethyl)-1,2-dimethoxybenzene **204**



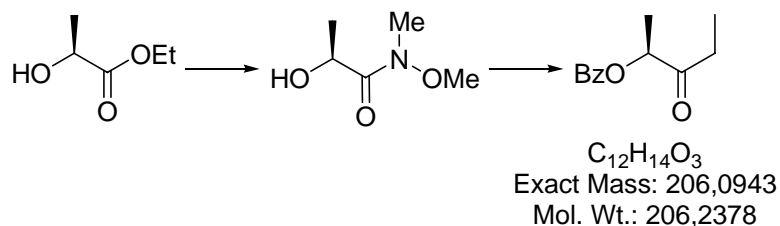
$\text{C}_9\text{H}_{11}\text{BrO}_2$
Exact Mass: 229,9942
Mol. Wt.: 231,0864

To a solution of 3,4-dimethoxybenzyl alcohol (5.00 g, 29.8 mmol) in CH_2Cl_2 (125 mL) was added PPh_3 (9.40 g, 35.7 mmol) and *N*-bromosuccinimide (5.80 g, 32.7 mmol), and the resulting mixture was stirred for 1 h at room temperature. The reaction volume was then reduced by evaporation and directly passed through a silica gel column (eluent, CH_2Cl_2) to afford bromide (5.30 g, 22.9 mmol, 77%) as white crystals.

$^1\text{H NMR}$ (300 MHz, CDCl_3) $\delta = 3.86$ (s, 3H), 3.88 (s, 3H), 4.49 (s, 2H), 6.79 (d, $J = 8.1$ Hz, 1H), 6.92 (m, 2H); $^{13}\text{C NMR}$ (75 MHz, CDCl_3) $\delta = 34.4$, 55.9, 111.1, 112.1, 121.6, 130.3, 149.1, 149.3. The spectroscopic data were in agreement to those previously reported.⁸

⁷ Gea, A.; Farcy, N.; Roqué i Rossell, N.; Martins, J. C.; De Clercq, P. J.; Madder, A. *Eur. J. Org. Chem.* **2006**, 4135–4146.

⁸ (a) Charlton, J. L.; Alauddin, M. M. *J. Org. Chem.* **1986**, *51*, 3490-3493. (b) Torrado, A.; Imperiali, B. *J. Org. Chem.* **1996**, *61*, 8940-8948.

(S)-2-Benzoyloxypentan-3-one 20

To a cooled ($-20\text{ }^{\circ}\text{C}$) mixture of ethyl (*S*)-lactate (20.0 g, 0.169 mol, 1.0 eq.) and MeON(Me)H·HCl (41.0 g, 0.420 mol, 2.5 eq.) in THF (150 mL), was added a 2 M solution of *i*-PrMgCl in Et₂O (0.420 L, 0.84 mol, 4.9 eq.) dropwise over 30 min. The reaction mixture was stirred at $-20\text{ }^{\circ}\text{C}$ for 30 min and at $0\text{ }^{\circ}\text{C}$ for a further 30 min before satd aq NH₄Cl solution (300 mL) was added. The mixture was extracted with Et₂O (4 × 50 mL), followed by CH₂Cl₂ (4 × 50 mL). The combined organic extracts were dried (MgSO₄), concentrated *in vacuo*, and the residue purified by distillation to give the amide (19.1 g, 0.144 mol, 85%) as a colourless oil.

To a cooled ($0\text{ }^{\circ}\text{C}$) solution of amide XX (10.0 g, 75.0 mmol, 1.0 eq.) in THF (100 mL) was added a 3 M solution of EtMgBr in Et₂O (80 mL, 240 mmol, 3.2 eq.) and the reaction mixture was allowed to warm to r.t. After 1 h, satd aq NH₄Cl solution (100 mL) was added and the mixture was extracted with Et₂O (80 mL) followed by CH₂Cl₂ (3 × 20 mL). The combined organic extracts were dried (MgSO₄) and concentrated to *ca.* 50 mL. To this solution was added Bz₂O (25.5 g, 113 mmol, 1.5 eq.), DMAP (1.0 g, 8.2 mmol, 0.1 eq.) and *i*-Pr₂NEt (25 mL, 143 mmol, 144 mmol, 1.9 eq.). After stirring for 14 h, excess Bz₂O was removed by addition of ethylenediamine (5.00 g, 83.0 mmol, 1.1 eq.). H₂O (120 mL) was added, the mixture extracted with Et₂O (4 × 30 mL), then the organic extracts were dried (MgSO₄) and concentrated to an oil. Column chromatography (hexanes / EtOAc = 4:1) afforded the ethyl ketone (11.8 g, 76%) as a colourless oil.

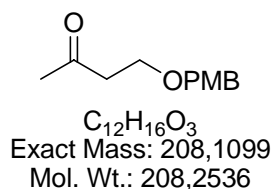
$[\alpha]_D^{20} = +25.1$ ($c = 4.0$, CHCl₃); ¹H NMR (300 MHz, CDCl₃) $\delta = 1.08$ (t, $J = 7.2$ Hz, 3H), 1.52 (d, $J = 7.0$ Hz, 3H), 2.58 (m, 2H), 5.34 (q, $J = 7.0$ Hz, 1H), 7.44 (m, 2H), 7.57 (m, 1H), 8.07 (m, 2H); ¹³C NMR (75 MHz, CDCl₃) $\delta = 7.2$, 16.5, 31.5, 75.1, 128.5, 129.5, 129.8, 133.4, 165.9, 208.5. The spectroscopic data were in agreement to those previously reported.⁹

⁹ Paterson, I.; Wallace, D. J.; Cowden, C. J. *Synthesis* **1998**, 639-652.

8.3 Total Synthesis of Archazolid

8.3.1 Synthesis of alcohol 64a for the C3-C13 subunit

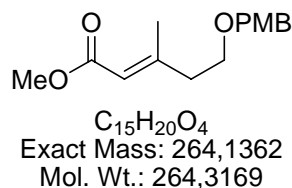
4-(4-methoxybenzyloxy)butan-2-one 61



A solution of CSA (5.53 g, 25.6 mmol, 0.06 eq.) in CH_2Cl_2 (360 ml) was treated with acetone-aldol (4-hydroxybutan-2-on (35.1 g, 398 mmol, 1.0 eq.) in CH_2Cl_2 (100 ml). At 0 °C, a solution of 4-methoxybenzyl-2,2,2-trichloroacetimidat (112 g, 397 mmol, 1.0 eq.) in CH_2Cl_2 (100 ml) was added and the resulting yellow solution was stirred over night. The solution was washed with sat. aqueous $NaHCO_3$ (700 mL) and the aqueous phase was extracted with Et_2O (2×600 ml). The combined organic phases were washed with sat. aqueous $NaHCO_3$ (350 mL) and with brine (350 mL). The organic phase was dried ($MgSO_4$) and the solvent evaporated *in vacuo*. The yellow residue was suspended in petroleum ether (50 mL) and the white precipitate was removed by filtration. Removal of the solvent *in vacuo* and silica gel chromatography (PE/EtOAc = 3:1) afforded the PMB-protected ketone (63.9 g, 77%) as a colorless oil.

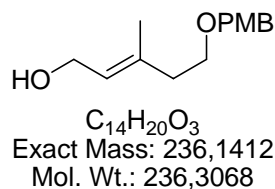
$R_f = 0.44$ (hexanes / EtOAc = 7:3); 1H NMR (400 MHz, $CDCl_3$) $\delta = 2.18$ (s, 3H), 2.70 (t, $J = 6.3$ Hz, 2H), 3.72 (t, $J = 6.3$ Hz, 2H), 3.81 (s, 3H), 4.45 (s, 2H), 6.88 (d, $J = 8.7$ Hz, 2H), 7.25 (d, $J = 8.6$ Hz, 2H); ^{13}C NMR (100 MHz, $CDCl_3$) $\delta = 30.4, 43.8, 55.3, 65.0, 72.9, 113.8, 129.3, 130.1, 159.3, 207.2$. The spectroscopic data were in agreement to those previously reported.¹⁰

¹⁰ Rai, N. A.; Basu, A. *Tetrahedron Lett.* **2003**, *44*, 2267-2270.

(E)-methyl 5-(4-methoxybenzyloxy)-3-methylpent-2-enoate 63

To a cooled (0 °C), stirred solution of the trimethyl phosphonoacetate (9.11 g, 50.0 mmol, 1.25 eq.) in THF (100 mL) was added potassium bis(trimethylsilyl)amide solution (~0.5 M in toluene, 100 mL, 50.0 mmol, 1.25 eq) in a period of 15 min. The mixture was stirred for 20 min at 0 °C, 30 min at ambient temperature and a solution of 4-(4-methoxybenzyloxy)-butan-2-one (8.33 g, 40.0 mmol, 1.0 eq.) in THF (25 mL) was added. After stirring for 19 h at ambient temperature, the reaction mixture was quenched with saturated aqueous NaCl (600 mL). The organic layer was separated and the aqueous layer was extracted with CH₂Cl₂ (3 × 100 mL). The combined organic layers were dried over MgSO₄, filtered and concentrated *in vacuo*. The residue was purified by column chromatography on silica gel (hexanes / Et₂O = 7:3) to give 6.52 g (24.7 mmol, 62%) of the desired ester (*E/Z* = 2:1) as a colourless oil.

R_f = 0.57 (hexanes / Et₂O = 7:3); ¹H NMR (300 MHz, CDCl₃) δ = 2.16 (s, 3H), 2.42 d(t, *J* = 6.6, 1.1 Hz, 2H), 3.56 (t, *J* = 6.6 Hz, 2H), 3.67 (s, 3H), 3.79 (s, 3H), 4.43 (s, 2H), 5.71 (m, 1H), 6.86 (m, 2H), 7.23 (m, 2H); ¹³C NMR (75 MHz, CDCl₃) δ = 19.0, 40.8, 50.8, 55.3, 67.5, 72.7, 113.9, 116.6, 129.3, 130.3, 157.0, 159.3, 167.0.

(E)-5-(4-methoxybenzyloxy)-3-methylpent-2-en-1-ol 64a

To a stirred solution (-78 °C) of the respective ester (10.8 g, 40.9 mmol, 1.0 eq.) in CH₂Cl₂ (160 mL) was added DIBAL-H (122.4 mL, 1M in *n*-hexane, 122.4 mmol, 3.0 eq.). After 1 h, Et₂O (160 mL) was added and the mixture was allowed to warm to room temperature. Dropwise addition of water (16 mL) led to the formation of a colourless gel. Upon addition of aqueous 2N NaOH (26 mL) and additional water (16 mL), a white solid precipitates. The resulting suspension was dried with MgSO₄. The mixture was filtered and the solvent was

evaporated *in vacuo* to afford the alcohol as a *E/Z* mixture (2:1) (8.85 g, 37.5 mmol, 96%). The mixture was separated by column chromatography on silica gel ($\text{CH}_2\text{Cl}_2 / \text{Et}_2\text{O} = 8:3$) to give the *E* configured alcohol (5.17 g, 21.9 mmol, 54%) as a colourless oil.

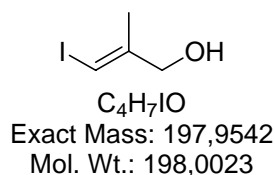
$R_f = 0.45$ ($\text{CH}_2\text{Cl}_2 / \text{Et}_2\text{O} = 8:3$); ^1H NMR (300 MHz, CDCl_3) $\delta = 1.67$ (s, 3H), 2.32 (t, $J = 6.8$ Hz, 2H), 3.53 (t, $J = 6.9$ Hz, 2H), 3.79 (s, 3H), 4.13 (d, $J = 6.8$ Hz, 2H), 4.43 (s, 2H), 5.44 (m, 1H), 6.86 (d, $J = 8.7$ Hz, 2H), 7.24 (d, $J = 8.9$ Hz, 2H); ^{13}C NMR (75 MHz, CDCl_3) $\delta = 16.5, 39.5, 55.3, 59.3, 68.3, 72.5, 113.8, 125.1, 129.3, 130.5, 136.7, 159.2$; MS (EI) calculated for $\text{C}_{14}\text{H}_{20}\text{O}_3$: 236.1, found: 236.2. The spectroscopic data were in agreement to those previously reported.¹¹

(*Z*)-5-(4-methoxybenzyloxy)-3-methylpent-2-en-1-ol: $R_f = 0.58$ ($\text{CH}_2\text{Cl}_2 / \text{Et}_2\text{O} = 8:3$); ^1H NMR (300 MHz, CDCl_3) $\delta = 1.72$ (s, 3H), 2.37 (t, $J = 6.2$ Hz, 2H), 3.49 (t, $J = 6.0$ Hz, 2H), 3.78 (s, 3H), 3.98 (d, $J = 7.5$ Hz, 2H), 4.43 (s, 2H), 5.68 (t, $J = 7.6$ Hz, 1H), 6.86 (d, $J = 8.8$ Hz, 2H), 7.22 (d, $J = 8.7$ Hz, 2H); ^{13}C NMR (75 MHz, CDCl_3) $\delta = 16.5, 39.5, 55.3, 59.3, 68.3, 72.5, 113.8, 125.1, 129.3, 130.5, 136.7, 159.2$.

8.3.2 Synthesis of the C14-C19 Subunit

8.3.2.1 Plan 1: Evans *anti* Aldol Reaction

(*E*)-3-iodo-2-methylprop-2-en-1-ol **90**

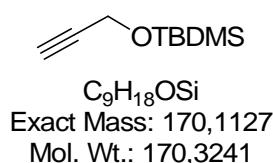


A suspension of Cp_2ZrCl_2 (4.25 g, 14.5 mmol, 1.0 eq.) in CH_2Cl_2 (60 mL) was treated at 0 °C with trimethylaluminum (2.0 M in toluene, 21.8 mL, 43.5 mmol, 3.0 eq) followed by addition of a solution of prop-2-yn-1-ol (815 mg, 14.5 mmol, 1.0 eq.) in CH_2Cl_2 (5 mL). The reaction mixture was stirred at room temperature for 24 h and then cooled down to -30 °C. A solution of I_2 (4.77 g, 18.8 mmol, 1.3 eq) in THF (40 mL) was added, and the mixture was stirred for 30 min at -30 °C and then allowed to warm to -10 °C. the reaction mixture was quenched by

¹¹ Nagano, H.; Nakanishi, E.; Takajo, S.; Sakuma, M.; Kudo, K. *Tetrahedron*. **1999**, *55*, 2591-2608.

addition of saturated aqueous NaHCO₃ (100 mL) at -30 °C. The layers were separated, and the aqueous layer was extracted with Et₂O (3 × 20 mL). The combined extract was dried over MgSO₄ and concentrated *in vacuo*. The residue was purified by column chromatography on silica gel (pentane / Et₂O = 4:1) to give the alcohol (618 mg, 3.12 mmol, 22%) as a light yellow oil. R_f = 0.18 (pentane / Et₂O 4:1); ¹H NMR (300 MHz, CDCl₃) δ = 1.81 (s, 1H), 1.83 (s, 3H), 4.10 (d, *J* = 1.3 Hz, 2H), 6.26 (m, 1H); ¹³C NMR (75 MHz, CDCl₃) δ = 21.3, 67.2, 77.3, 147.2. The spectroscopic data were identical to those previously reported.¹²

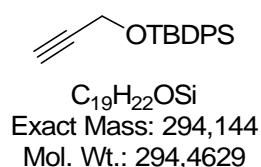
tert-butyldimethyl(prop-2-ynyloxy)silane 84



To a solution of the alcohol (1.43 g, 25.5 mmol, 1.0 eq.) in abs. THF (50 mL) was added TBSCl (9.61 g, 63.8 mmol, 2.5 eq.), imidazol (6.07 g, 89.3 mmol, 3.5 eq.) and DMAP (318 mg, 2.60 mmol, 0.1 eq). The reaction mixture was stirred at RT for 120 min. Sat. aq. NaHCO₃ (50 mL) were added, the organic phase separated, and the aq. phase thoroughly extracted with DCM (3 x 20 mL). The combined organic extracts were dried over MgSO₄ and concentrated *in vacuo*. After flash chromatography (hexanes / Et₂O = 30:1) the TBS-ether (3.55 g, 20.8 mmol, 82%) was obtained as colourless oil.

R_f = 0.71 (hexanes / Et₂O = 30:1); ¹H NMR (300 MHz, CDCl₃) δ = 0.12 (s, 6H), 0.90 (s, 9H), 2.37 (t, *J* = 2.4 Hz, 1H), 4.30 (d, *J* = 2.5 Hz, 3H); ¹³C NMR (75 MHz, CDCl₃) δ = -5.2, 18.3, 25.8, 51.5, 72.8, 82.5.

tert-butyldiphenyl(prop-2-ynyloxy)silane 85

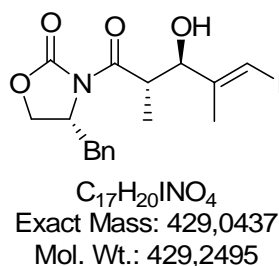


¹² White, J. D.; Blakemore, P. R.; Green, N. J.; Hauser, E. B.; Holoboski, M. A.; Keown, L. E.; Nylund Kolz, C. S.; Phillips, B. W. *J. Org. Chem.* **2002**, *67*, 7750-7760.

To a solution of the alcohol (561 mg, 10.0 mmol, 1.0 eq.) and imidazol (886 mg, 13.0 mmol, 1.3 eq.) in abs. DCM (10 mL) was added TBDPSCl (2.76 g, 10.0 mmol, 1.0 eq.) at 0 °C. The reaction mixture was warmed to RT and stirred for 30 min. Sat. aq. NaHCO₃ (20 mL) were added, the organic phase separated, and the aq. phase thoroughly extracted with DCM (3 x 15 mL). The combined organic extracts were dried over MgSO₄ and concentrated *in vacuo*. After flash chromatography (hexanes / Et₂O = 30:1) the TBS-ether (2.95 g, 10.0 mmol, 100%) was obtained as colourless oil.

R_f = 0.61 (hexanes / Et₂O = 30:1); ¹H NMR (300 MHz, CDCl₃) δ = 1.07 (s, 9H), 2.37 (t, *J* = 2.4 Hz, 1H), 4.31 (d, *J* = 2.4 Hz, 3H), 7.41 (m, 6H), 7.71 (m, 4H); ¹³C NMR (75 MHz, CDCl₃) δ = 19.2, 26.7, 52.5, 73.0, 82.1, 127.8, 129.9, 133.0, 135.6.

(R)-4-benzyl-3-((2S,3R,E)-3-hydroxy-5-iodo-2,4-dimethylpent-4-enoyl)oxazolidin-2-one
92



To a stirred solution of (*E*)-3-iodo-2-methylprop-2-en-1-ol (216 mg, 1.09 mmol, 1.0 eq.) in Et₂O (5 mL) was added MnO₂ (1.42 g, 16.3 mmol, 15 eq.) at room temperature. The resulting suspension was stirred for 3 h. Then the suspension was filtered and the solvent of the filtrate was removed at 40 °C, to give XX in quantitative yield (214 mg, 1.09 mmol), which was used without further purification, due to its volatility.

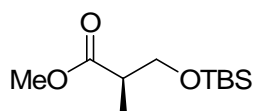
The aldehyde (98.0 mg, 0.500 mmol, 1.0 eq.) was dissolved in EtOAc (2 mL) and added to neat propionyl oxazolidinone (175 mg, 7.50 mmol, 1.5 eq.). The reaction mixture was then treated at rt with anhydrous MgCl₂ (48.0 mg, 0.504 mmol, 1.0 eq.), Et₃N (174 μL, 1.25 mmol, 2.5 eq.), and TMSCl (128 μL, 1.00 mmol, 2.0 eq.). After stirring for 52 h, the reaction mixture was filtered through a silica plug (Et₂O) and the filtrate was concentrated under reduced pressure. The residual oil was dissolved in MeOH (3 mL), treated with TFA (1 drop) and stirred for 10 min. Toluene (3 mL) was added and the reaction mixture was concentrated under reduced pressure. Purification of the crude product by column chromatography on silica

gel (hexanes / EtOAc, gradient elution, 9:1 to 4:1) afforded aldol product (62.0 mg, 0.144 mmol, 29%) as a white solid.

$R_f = 0.28$ (hexanes / EtOAc = 4:1); $[\alpha]_D^{20} = -37.0$ ($c = 1.41$, CHCl_3); $^1\text{H-NMR}$ (300 MHz, CDCl_3) $\delta = 1.11$ (d, $J = 7.0$ Hz, 3H), 1.88 (s, 3H), 2.77 (dd, $J = 13.5, 9.4$ Hz, 1H), 3.05 (d, $J = 7.1$ Hz, 1H), 3.27 (dd, $J = 13.5, 3.3$ Hz, 1H), 4.18 (m, 3H), 4.33 (t, $J = 7.9$ Hz, 1H), 6.48 (m, 1H), 6.39 (s, 3H), 7.22 (m, 2H), 7.28 (m, 1H), 7.33 (m, 2H); $^{13}\text{C-NMR}$ (75 MHz, CDCl_3) $\delta = 14.7, 19.4, 37.8, 40.4, 55.5, 66.2, 79.8, 80.8, 127.4, 129.0, 129.5, 135.1, 147.5, 153.7, 176.0$; HRMS calculated for $\text{C}_{17}\text{H}_{19}\text{INO}_4$ [M] $^-$: 428.0359, found: 428.0360.

8.3.2.2 Plan 2: *Noyori's* asymmetric transfer hydrogenation

(*R*)-methyl 3-(tert-butyldimethylsilyloxy)-2-methylpropanoate 99

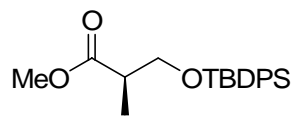


$\text{C}_{11}\text{H}_{24}\text{O}_3\text{Si}$
Exact Mass: 232,1495
Mol. Wt.: 232,392

To a solution of (*R*)-methyl 3-hydroxy-2-methylpropanoate (510 mg, 4.32 mmol, 1.0 eq.) in THF (30 mL) was added TBS-Cl (1.63 g, 10.8 mmol, 2.5 eq.), imidazole (1.47 g, 21.6 mmol, 5.0 eq.) and DMAP (50.0 mg, 0.41 mmol, 0.1 eq.). The reaction mixture was stirred at room temperature for 1.5 h. Sat. aq. NaHCO_3 (30 mL) were added, the organic phase separated, and the aq. phase thoroughly extracted with Et_2O (3×20 mL). The combined organic extracts were dried over MgSO_4 and concentrated *in vacuo*. Flash chromatography (hexanes / EtOAc = 10:1) gave the TBS-ether (888 mg, 3.82 mmol, 88%) as colourless oil.

$R_f = 0.71$ (hexanes / EtOAc = 10:1); $^1\text{H NMR}$ (300 MHz, CDCl_3) $\delta = 0.02$ (s, 6H), 0.86 (s, 9H), 1.13 (d, $J = 7.2$ Hz, 3H), 2.63 (m, 1H), 3.64 (dd, $J = 9.7, 6.9$ Hz, 1H), 3.66 (dd, $J = 9.6, 6.0$ Hz, 1H); $^{13}\text{C NMR}$ (75 MHz, CDCl_3) $\delta = -5.5, 13.5, 18.2, 25.8, 42.6, 51.5, 65.3, 175.5$; The spectroscopic data were in agreement to those previously reported.¹³

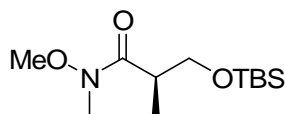
¹³ Mori, K.; Koseki, K. *Tetrahedron* **1988**, *44*, 6013-6020.

(R)-methyl 3-(tert-butylphenylsilyloxy)-2-methylpropanoate 100

$C_{21}H_{28}O_3Si$
Exact Mass: 356,1808
Mol. Wt.: 356,5307

To a solution of (*R*)-methyl 3-hydroxy-2-methylpropanoate (1.75 g, 14.8 mmol, 1.0 eq.) and imidazole (1.31 g, 19.2 mmol, 1.3 eq.) in DCM (15 mL) was added TBSCl (4.08 g, 14.8 mmol, 1.0 eq.) at 0 °C. The reaction mixture was warmed up to r.t. and stirred for 30 min. Sat. aq. $NaHCO_3$ (40 mL) were added, the organic phase separated, and the aq. phase thoroughly extracted with DCM (3 × 20 mL). The combined organic extracts were dried over $MgSO_4$ and concentrated *in vacuo*. Flash chromatography (hexanes / EtOAc = 20:1) gave the TBS-ether (5.16 g, 14.5 mmol, 98%) as colourless oil.

R_f = 0.47 (hexanes / EtOAc = 20:1); 1H NMR (400 MHz, $CDCl_3$) δ = 1.03 (s, 9H), 1.15 (d, J = 7.1 Hz, 3H), 2.71 (m, 1H), 3.67 (s, 3H), 3.72 (dd, J = 9.7, 5.6 Hz, 1H), 3.83 (dd, J = 9.7, 5.7 Hz, 1H), 7.40 (m, 6H), 7.64 (m, 4H); ^{13}C NMR (100 MHz, $CDCl_3$) δ = 13.5, 19.3, 26.8, 42.5, 51.5, 66.0, 127.7, 129.7, 133.6, 133.7, 135.6, 175.3; MS (EI) calculated for $C_{21}H_{28}O_3Si$: 356.2, found: 356.2. The spectroscopic data were in agreement to those previously reported.¹⁴

(R)-3-(tert-butyltrimethylsilyloxy)-*N*-methoxy-*N*,2-dimethylpropanamide 101

$C_{12}H_{27}NO_3Si$
Exact Mass: 261,176
Mol. Wt.: 261,4332

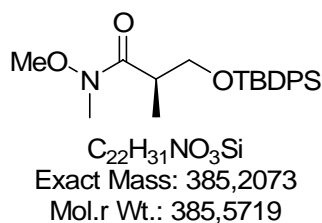
Ester (620 mg, 2.67 mmol, 1.0 eq.) and *N,O*-Dimethylhydroxylamine hydrochloride (390 mg, 4.00 mmol, 1.5 eq.) were suspended in THF (10 mL), cooled to -20 °C and treated with *i*PrMgCl (~2 M in Et_2O , 4.0 mL, 8.0 mmol, 3.0 eq.) over 5 min to create a homogeneous

¹⁴ Smith III, A. B.; Condon, S. M.; McCauley, J. A.; Leahy, J. W.; Leazer, Jr., J. L.; Maleczka, Jr., R. E. *Tetrahedron Lett.* **1994**, 35, 4907-4910.

reaction mixture. After stirring at $-10\text{ }^{\circ}\text{C}$ for additional 15 min, the reaction was quenched by addition of sat. aq. NH_4Cl (20 mL). The product was extracted into DCM ($3 \times 10\text{ mL}$), and the combined organic layers were dried over MgSO_4 , concentrated to afford amide (627 mg, 2.40 mmol, 90%).

$R_f = 0.23$ (hexanes / EtOAc = 10:1); $^1\text{H NMR}$ (400 MHz, CDCl_3) $\delta = 0.02$ (s, 3H), 0.03 (s, 3H), 0.86 (s, 9H), 1.06 (d, $J = 7.1$ Hz, 3H), 3.13 (m, 1H), 3.12 (s, 3H), 3.51 (dd, $J = 9.7, 6.1$ Hz, 1H), 3.70 (s, 3H), 3.82 (dd, $J = 9.7, 8.1$ Hz, 1H); $^{13}\text{C NMR}$ (100 MHz, CDCl_3) $\delta = -5.4, 13.8, 18.3, 25.9, 32.2, 38.2, 61.5, 65.8, 175.2$.

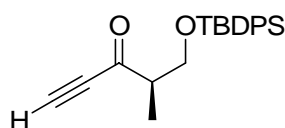
(*R*)-3-(tert-butyldiphenylsilyloxy)-*N*-methoxy-*N*,2-dimethylpropanamide 102



Ester (3.65 g, 10.2 mmol, 1.0 eq.) and *N,O*-Dimethylhydroxylamine hydrochloride (1.47 g, 15.1 mmol, 1.5 eq.) were suspended in THF (40 mL), cooled to $-20\text{ }^{\circ}\text{C}$ and treated with *i*PrMgCl (~2 M in Et_2O , 15.0 mL, 30.0 mmol, 3.0 eq.) over 15 min to create a homogeneous reaction mixture. After stirring at $-10\text{ }^{\circ}\text{C}$ for additional 15 min, the reaction was quenched by addition of sat. aq. NH_4Cl (100 mL). The product was extracted into DCM ($3 \times 10\text{ mL}$), and the combined organic layers were dried over MgSO_4 , concentrated in vacuo. Flash chromatography (hexanes / EtOAc = 4:1) gave the amide (3.66 g, 9.49 mmol, 93%) as white solid.

$R_f = 0.37$ (hexanes / EtOAc = 4:1); $^1\text{H NMR}$ (300 MHz, CDCl_3) $\delta = 1.03$ (s, 9H), 1.08 (d, $J = 7.1$ Hz, 3H), 3.19 (m, 1H), 3.19 (s, 3H), 3.59 (dd, $J = 9.6, 6.2$ Hz, 1H), 3.65 (s, 3H), 3.93 (dd, $J = 9.5, 8.0$ Hz, 1H), 7.39 (m, 6H), 7.66 (m, 4H); $^{13}\text{C NMR}$ (75 MHz, CDCl_3) $\delta = 13.8, 19.2, 26.8, 32.2, 38.1, 61.5, 66.3, 127.6, 129.6, 133.6, 133.8, 135.6, 176.0$; HRMS calculated for $\text{C}_{22}\text{H}_{31}\text{NO}_3\text{SiNa}$ $[\text{M}+\text{Na}]^+$: 408.1971, found: 408.1973.

(*R*)-5-(tert-butyldiphenylsilyloxy)-4-methylpent-1-yn-3-one 105

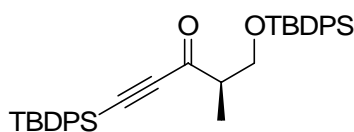


$C_{22}H_{26}O_2Si$
Exact Mass: 350,1702
Mol. Wt.: 350,5261

To a solution of amide (426 mg, 1.10 mmol, 1.0 eq.) in THF (10 mL) was added Lithium acetylide ethylenediamine complex (254 mg, 2.76 mmol, 2.5 eq.) at 0 °C. The reaction mixture was stirred for 60 min at room temperature. H₂O (10 mL) were added, the organic phase separated, and the aq. phase thoroughly extracted with DCM (3 × 10 mL). The combined organic extracts were dried over MgSO₄ and concentrated *in vacuo*. Flash chromatography (hexanes / Et₂O = 30:1) gave ketone (100 mg, 0.285 mmol, 26%) as colourless oil.

$R_f = 0.29$ (hexanes / Et₂O = 20:1); ¹H NMR (300 MHz, CDCl₃) $\delta = 1.03$ (s, 9H), 1.18 (d, $J = 7.0$ Hz, 3H), 2.83 (m, 1H), 3.16 (s, 1H), 3.89 (m, 2 H), 7.39 (m, 6H), 7.65 (m, 4H); ¹³C NMR (75 MHz, CDCl₃) $\delta = 12.7, 19.7, 27.1, 51.4, 65.5, 79.5, 81.1, 128.1, 130.1, 133.6, 136.0, 189.9$.

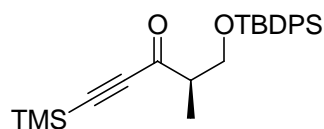
(6*R*,11*R*)-2,2,6,11,15,15-hexamethyl-3,3,14,14-tetraphenyl-4,13-dioxa-3,14-isilahexadec-8-yne-7,10-dione **104**



$C_{38}H_{44}O_2Si_2$
Exact Mass: 588,288
Mol. Wt.: 588,9258

Ketone **104** (66.8 mg, 0.113 mmol, 10%) was as colourless oil.

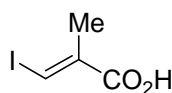
$R_f = 0.39$ (hexanes / Et₂O = 20:1); ¹H NMR (300 MHz, CDCl₃) $\delta = 1.02$ (s, 9H), 1.11 (s, 9H), 1.24 (d, $J = 7.0$ Hz, 3H), 2.91 (m, 1H), 3.90 (m, 1H), 4.01 (m, 1 H), 7.37 (m, 12H), 7.64 (dd, $J = 7.9, 1.5$ Hz, 4H), 7.74 (dd, $J = 7.8, 16$ Hz, 4H); ¹³C NMR (75 MHz, CDCl₃) $\delta = 12.8, 18.7, 19.3, 26.8, 27.0, 51.3, 65.4, 94.2, 104.6, 127.7, 128.0, 129.7, 130.0, 131.5, 133.3, 135.6, 189.5$; HRMS calculated for C₃₈H₄₈NO₂Si₂ [M+NH₄]⁺: 606.3224, found: 606.3214.

(R)-5-(tert-butyldiphenylsilyloxy)-4-methyl-1-(trimethylsilyl)pent-1-yn-3-one 106

$C_{25}H_{34}O_2Si_2$
Exact Mass: 422,2097
Mol. Wt.: 422,7073

To a stirred solution of trimethylsilylacetylene (0.17 mL, 1.2 mmol, 1.2 eq) in anhydrous THF (4 mL) at $-78\text{ }^{\circ}\text{C}$, a solution of *n*BuLi in hexanes (0.94 mL, 1.5 mmol, 1.5 eq) were added dropwise. After stirring for 30 min, a solution of amide (386 mg, 1.00 mmol, 1.0 eq) in anhydrous THF (5 mL) was dropwise added and the mixture was allowed to warm to room temperature. After 3 h, pH 7 phosphate buffer (10 mL) was slowly added *via* cannula and the mixture was partitioned with diethyl ether ($3 \times 10\text{ mL}$). The organic layer was dried over $MgSO_4$, filtered and carefully concentrated *in vacuo*. The crude which was purified by a short flash chromatography (hexanes / $Et_2O = 20:1$) to yield 165 mg (0.390 mmol, 39%) of (R)-5-(tert-butyldiphenylsilyloxy)-4-methyl-1-(trimethylsilyl)pent-1-yn-3-one as a colourless oil.

$R_f = 0.52$ (hexanes / $Et_2O = 20:1$); 1H NMR (400 MHz, $CDCl_3$) $\delta = 0.22$ (s, 9H), 1.03 (s, 9H), 1.17 (d, $J = 6.6\text{ Hz}$, 3H), 2.82 (m, 1H), 3.88 (m, 2H), 7.40 (m, 6H), 7.65 (m, 4H); ^{13}C NMR (100 MHz, $CDCl_3$) $\delta = -0.7, 12.6, 19.4, 26.8, 50.8, 65.5, 98.7, 101.4, 127.7, 129.7, 133.4, 135.6, 190.1$.

8.3.2.3 Plan 3: Abiko-Masamune anti Aldol Reaction**(E)-3-Iodo-2-methylacrylic acid 113**

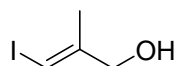
$C_4H_5IO_2$
Exact Mass: 211,9334
Mol. Wt.: 211,9858

A solution of diethyl methylmalonate (33.2 g, 0.190 mol, 1.0 eq) in Et_2O (60 mL) was added to NaH (55-65% in mineral oil, 9.21 g, 0.230 mol, 1.2 eq) in Et_2O (120 mL) during 40 min with vigorous stirring and the resulting mixture was refluxed for 3 h. After being cooled to ambient temperature, CHI_3 (75.0 g, 0.190 mol, 1 eq) was added during 30 min and the

mixture was refluxed for 32 h. At 0 °C 10% aqueous HCl (100 mL) was added and the mixture stirred for 20 min. The organic layer was separated and the aqueous layer was extracted with Et₂O (3 × 30 mL). The combined organic layers were dried over MgSO₄ and concentrated in vacuum. The residue was dissolved in EtOH/H₂O (3:1, 520 mL) and KOH (28.1 g, 0.500 mol) was added. The mixture was refluxed for 24 h. After being cooled to ambient temperature, the mixture was concentrated in vacuum. The residue was redissolved in 10% aqueous K₂CO₃ (300 mL) and the precipitated CHI₃ was removed by filtration. The filtrate was washed with CH₂Cl₂ (2 × 50 mL) and acidified with 12 M HCl (pH < 1, 130 mL) and extracted with CH₂Cl₂ (8 × 50 mL). The combined organic layers were dried over MgSO₄ and concentrated in vacuum. The residue was purified by column chromatography on silica gel (hexanes / EtOAc = 10:1, 0.5% AcOH) to give of the carboxylic acid (31.1 g, 0.147 mol, 77%, over two steps) as a white solid.

R_f = 0.25 (hexanes / EtOAc = 10:1, 0.5% AcOH); mp. 58 °; ¹H NMR (300 MHz, CDCl₃) δ = 2.05 (s, 3H), 8.03 (s, 1H), 12.08 (s, 1H); ¹³C NMR (75 MHz, CDCl₃) δ = 19.8, 102.0, 139.0, 169.2. HRMS calculated for C₄H₄IO₂ [M-H]: 210.9256, found: 210.9254. The spectroscopic data were identical to those previously reported.¹⁵

(E)-3-iodo-2-methylprop-2-en-1-ol 90



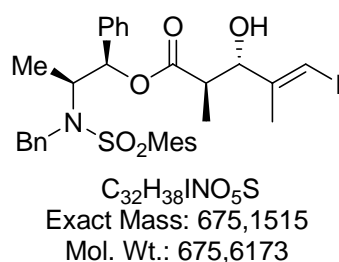
C₄H₇IO
Exact Mass: 197,9542
Mol. Wt.: 198,0023

To a cooled (0 °C), stirred solution of the carboxylic acid (5.30 g, 25.0 mmol, 1.0 eq) in Et₂O (50 mL) was added LiAlH₄ (0.950 g, 25.0 mmol, 1.0 eq) in a period of 10 min. The mixture was stirred for 4 h at ambient temperature and additional LiAlH₄ (95.0 mg, 2.50 mmol, 0.1 eq) was added and the mixture was stirred for 30 min. The reaction mixture was cooled to 0 °C and quenched with saturated aqueous Na₂SO₄ (1.5 mL). Et₂O (30 mL) and 2 M aqueous H₂SO₄ (50 mL) were added. The organic layer was separated and the aqueous layer was extracted with CH₂Cl₂ (3 × 15 mL). The combined organic layers were concentrated in vacuum and the remaining oil dissolved in CH₂Cl₂ (30 mL) and washed with 10% aqueous K₂CO₃ (20 mL). The aqueous layer was extracted with CH₂Cl₂ (3 × 15 mL). The combined

¹⁵ Baker, R.; Castro, J. L. *J.Chem. Soc., Perkin Trans. I* **1990**, 47.

organic layers were dried over MgSO_4 and concentrated in vacuum. The residue was purified by column chromatography on silica gel (pentane / Et_2O = 4:1) to give the alcohol (4.45 g, 22.5 mmol, 85%) as a light yellow oil. R_f = 0.18 (pentane / Et_2O 4:1); ^1H NMR (300 MHz, CDCl_3) δ = 1.81 (s, 1H), 1.83 (s, 3H), 4.10 (d, J = 1.3 Hz, 2H), 6.26 (m, 1H); ^{13}C NMR (75 MHz, CDCl_3) δ = 21.3, 67.2, 77.3, 147.2. spectroscopic data were identical to those previously reported.¹⁵

(2*R*,3*S*,*E*)-((1*R*,2*S*)-2-(*N*-benzyl-2,4,6-trimethylphenylsulfonamido)-1-phenylpropyl)-3-hydroxy-5-iodo-2,4-dimethylpent-4-enoate 114

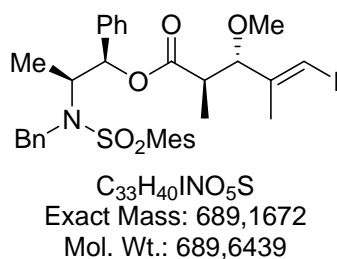


To a stirred solution of (*E*)-3-iodo-2-methylprop-2-en-1-ol (4.53 g, 22.9 mmol, 1.0 eq.) in CH_2Cl_2 (50 mL) was added MnO_2 (5.92 g, 68.1 mmol, 20 eq.) at room temperature. The resulting suspension was stirred for 1 h. Then the suspension was filtered and the solvent of the filtrate was removed at 40 °C, to give the aldehyde in quantitative yield (4.49 g, 22.9 mmol), which was used without further purification, due to its volatility.

In the next step a solution of (1*R*,2*S*)-2-(*N*-benzyl-2,4,6-trimethylphenyl-sulfonamido)-1-phenylpropyl propionate XX (5.00 g, 10.4 mmol, 1.0 eq.) and NEt_3 (3.60 mL, 26.0 mmol, 2.5 eq.) in CH_2Cl_2 (80 mL) under argon atmosphere was cooled down to -78 °C. Then dicyclohexyl-(trifluoromethylsulfonyloxy)borane (26.0 mL, 1M in *n*-Hexane, 26.0 mmol, 2.5 eq.) was added slowly. The resulting mixture was stirred for 5h at -78 °C, before a solution of the aldehyde (4.49 g, 22.9 mmol, 2.2 eq.) in 15 mL CH_2Cl_2 (dried with 3Å molecular siever) was added slowly. After further 60 min the reaction mixture was warmed up to room temperature (ca. 2h), quenched with pH 7 buffer (50 mL), diluted with MeOH (200 mL) and charged with 26 mL of a H_2O_2 -solution, before the mixture was stirred overnight. After that, the solvent was removed in vacuo and the residue was dissolved in CH_2Cl_2 (250 mL). The organic layer was washed with H_2O , separated and the aqueous phase was reextracted with CH_2Cl_2 (3 × 100 mL). The combined organic layer was dried over Na_2SO_4 , filtered and the

solvent was removed *in vacuo*. The residue was purified by column chromatography (hexanes / EtOAc = 8:1) to give the aldol product as white crystals (6.74 g, 9.98 mmol, 96%). $R_f = 0.43$ (hexanes / EtOAc = 8:1); mp. 72 °C; $[\alpha]_D^{20} = +38.9$ (c = 0.97, CHCl₃); ¹H NMR (300 MHz, CDCl₃) $\delta = 0.95$ (d, $J = 7.2$ Hz, 3H), 1.17 (d, $J = 7.0$ Hz, 3H), 1.81 (d, $J = 1.1$ Hz, 3H), 2.27 (s, 3H), 2.50 (s, 6H), 2.54-2.65 (m, 1H), 2.77 (d, $J = 3.8$ Hz, 1H, OH), 4.10 (dq, $J = 4.1, 7.0$ Hz, 1H), 4.24 (dd, $J = 3.4$ Hz, 1H), 4.56 (A of ABq, $J_{AB} = 16.6$, 1H), 4.74 (B of ABq, $J_{AB} = 16.6$, 1H), 5.85 (d, $J = 4.1$ Hz, 1H), 6.29 (s, 1H), 6.82-6.85 (m, 2H), 6.87 (s, 2H), 7.13-7.35 (m, 8H); ¹³C NMR (75 MHz, CDCl₃) $\delta = 13.4, 14.1, 18.9, 20.9, 23.0, 43.3, 48.3, 56.8, 78.6, 78.7, 81.2, 125.9, 127.2, 127.6, 128.0, 128.4, 128.5, 132.2, 133.4, 138.1, 138.6, 140.3, 142.6, 146.9, 174.1$; HRMS calculated for C₃₂H₃₈INNaO₅S: 698.1413, found: 698.1409.

(2R,3S,E)-((1R,2S)-2-(N-benzyl-2,4,6-trimethylphenylsulfonamido)-1-phenylpropyl) 5-iodo-3-methoxy-2,4-dimethylpent-4-enoate 115

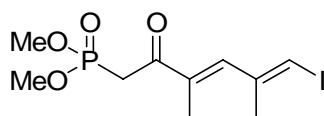


To a solution of the alcohol (3.92 g, 5.80 mmol, 1 eq.) in Et₂O (40 mL) under argon atmosphere were added molecular sieves 3Å (13 g), Ag₂O (5.37 mg, 23.2 mmol, 4 eq.) and CH₃I (4.34 mL, 70.0 mmol, 12 eq.) subsequently. The resulting mixture was stirred for 48 h at ambient temperature and filtered through cotton afterwards. The solvent was evaporated and the crude product was purified by column chromatography on silica gel (hexanes / EtOAc = 10:1) to receive the desired methyl ether (3.75 g, 5.44 mmol, 94%) as white crystals.

$R_f = 0.36$ (hexanes / EtOAc = 15:1); m.p. 76 °C; $[\alpha]_D^{20} = +44.8$ (c = 0.96, CHCl₃); ¹H NMR (300 MHz, CDCl₃) $\delta = 0.88$ (d, $J = 7.2$ Hz, 3H), 1.10 (d, $J = 7.0$ Hz, 3H), 1.77 (d, $J = 0.94$ Hz, 3H), 2.30 (s, 3H), 2.53 (s, 6H), 2.69-2.80 (m, 1H), 3.09 (s, 3H), 3.81 (d, $J = 10.2$ Hz, 1H), 4.02 (dq, $J = 4.0, 7.0$ Hz, 1H), 4.39 (A of ABq, $J_{AB} = 16.8$, 1H), 4.96 (B of ABq, $J_{AB} = 16.6$, 1H), 5.70 (d, $J = 3.8$ Hz, 1H), 6.32 (s, 1H), 6.68-6.73 (m, 2H), 6.93 (s, 2H), 7.11-7.28 (m, 6H); 7.38-7.41 (m, 2H); ¹³C NMR (75 MHz, CDCl₃) $\delta = 13.5, 13.8, 18.0, 20.9, 22.9, 43.2, 48.2, 56.3, 56.8, 78.1, 81.9, 88.5, 125.8, 126.2, 127.0, 127.8, 128.3, 128.4, 132.2, 133.8, 138.4,$

139.4, 140.4, 142.6, 144.9, 173.6; HRMS calculated for $C_{33}H_{40}INNaO_5S$: 712.1570, found: 712.1567.

Dimethyl (3*E*,5*E*)-6-iodo-3,5-dimethyl-2-oxohexa-3,5-dienylphosphonate 135

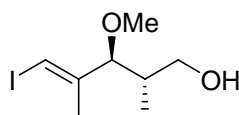


$C_{10}H_{16}IO_4P$
Exact Mass: 357,9831
Mol. Wt.: 358,1099

Dimethyl methylphosphonate (30.0 μ L, 0.281 mmol, 2.0 eq.) in THF (3 mL) at -78 $^{\circ}$ C was treated with *n*BuLi (1.6M in hexane, 130 μ L, 0.208 mmol, 1.5 eq.). After stirring at -50 $^{\circ}$ C for 1.5 h, the mixture was recooled to -78 $^{\circ}$ C and a solution of the ester (100 mg, 0.145 mmol, 1.0 eq.) in THF (3 mL) was added. The reaction mixture was stirred at -78 $^{\circ}$ C for 60 min, and then treated with saturated aqueous NH_4Cl solution. The organic layer was separated and the aqueous layer was extracted with EtOAc (4 \times 10 mL). The combined organic layers were dried ($MgSO_4$) and concentrated under reduced pressure. Purification by flash chromatography (hexanes / EtOAc = 1:1) gave the respective phosphonate (20.8 mg, 55.6 μ mol, 38%).

R_f = 0.19 (hexanes / EtOAc = 1:1); 1H -NMR (400 MHz, $CDCl_3$) δ = 1.90 (s, 3H), 2.04 (s, 3H), 3.36 (d, J = 22.4 Hz, 2H), 3.75 (s, 3H), 3.78 (s, 3H), 6.54 (s, 1H), 6.97 (s, 1H); ^{13}C -NMR (75 MHz, $CDCl_3$) δ = 13.1, 17.9, 42.2, 43.9, 48.5, 53.0, 56.4, 81.7, 89.3, 145.1, 205.; HRMS calculated for $C_{10}H_{16}IO_4PNa$ [$M+Na$] $^+$: 380.9729, found: 380.9727.

(2*S*,3*S*,*E*)-5-iodo-3-methoxy-2,4-dimethylpent-4-en-1-ol 133



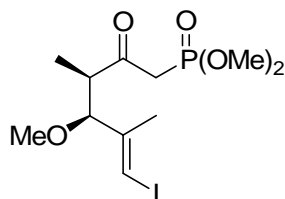
$C_8H_{15}IO_2$
Exact Mass: 270,0117
Mol. Wt.: 270,108

A solution of the prepared methyl ether (3.70 g, 5.37 mmol, 1.0 eq.) in Et_2O (30 mL) was cooled down to 0 $^{\circ}$ C. Then the solution was treated with $LiAlH_4$ (204 mg, 5.37 mmol, 1.0 eq.)

and stirred for 2 h at this temperature, before it was warmed up to room temperature. Then the mixture was quenched by addition of a saturated aqueous Na₂SO₄ solution (20 mL). After this the solution was acidified to pH = 2 by addition of 2M H₂SO₄ (12 mL). The organic layer was separated and the aqueous layer was extracted with Et₂O (3 × 40 mL). The combined organic layer was washed with saturated, aqueous NaHCO₃ solution and brine, dried over MgSO₄, filtered and the solvent was removed under reduced pressure. The residue was purified by flash chromatography on silica gel (pentane / Et₂O = 3:1) to give 1.39 g (5.15 mmol, 97%) of the desired alcohol as light yellow oil.

$R_f = 0.16$ (pentane / Et₂O = 3:1); $[\alpha]_D^{20} = -28.7$ ($c = 1.48$, CHCl₃); ¹H NMR δ (400 MHz, CDCl₃) ppm 0.70 (d, $J = 6.6$ Hz, 3H), 1.74 (s, 3H), 1.87-1.97 (m, 1H), 3.00 (br s, 1H, OH), 3.19 (s, 3H), 3.51 (d, $J = 9.7$ Hz, 1H), 3.60 (d, $J = 5.6$ Hz, 2H), 6.21 (s, 1H); ¹³C-NMR (100 MHz, CDCl₃) $\delta = 13.6, 18.4, 37.6, 56.4, 67.8, 80.5, 92.6, 146.4$; HRMS calculated for C₈H₁₅IO₅: 270.0117, found: 270.0117.

Dimethyl (3*R*,4*S*,*E*)-6-iodo-4-methoxy-3,5-dimethyl-2-oxohex-5-enylphosphonate 118



C₁₁H₂₀IO₅P
Exact Mass: 390,0093
Mol. Wt.: 390,1517

To a solution of primary alcohol (55.0 mg, 0.204 mmol, 1.0 eq.) in CH₂Cl₂ (3 mL) at 0 °C was added *Dess-Martin* periodinane (94.0 mg, 0.222 mmol, 1.1 eq.). After stirring for 2 h, the reaction mixture was treated with saturated aqueous Na₂S₂O₃ solution and saturated aqueous NaHCO₃ solution. The organic layer was separated and the aqueous layer was extracted with CH₂Cl₂ (3 × 5 mL). The combined organic layers were dried (MgSO₄) and concentrated under reduced pressure.

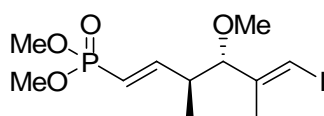
In a separate flask, dimethyl methylphosphonate (218 μ L, 2.04 mmol, 10 eq.) in THF (250 μ L) at -78 °C was treated with *n*-BuLi (2.5M in hexane, 816 μ L, 2.04 mmol, 10 eq.). After stirring for 1 h, the crude aldehyde obtained from the *Dess-Martin* oxidation was dissolved in THF (200 μ L) and added to the mixture. The reaction mixture was warmed to 0 °C, stirred for 15 min, and then treated with saturated aqueous NH₄Cl solution. The organic layer was

separated and the aqueous layer was extracted with EtOAc (4×5 mL). The combined organic layers were dried (MgSO_4) and concentrated under reduced pressure. Purification by flash chromatography (hexanes / EtOAc = 1:2 to 0:1) gave the respective secondary alcohol (42.4 mg, 108 μmol , 53%, two steps), which was used in the next step.

The secondary alcohol (14.0 mg, 36.0 μmol , 1.0 eq.) was dissolved in CH_2Cl_2 (2 mL), and *Dess-Martin* periodinane (17.0 mg, 39.0 μmol , 1.1 eq.) was added at r.t. After stirring for 30 min, the reaction mixture was treated with saturated aqueous $\text{Na}_2\text{S}_2\text{O}_3$ solution and saturated aqueous NaHCO_3 solution. The organic layer was separated and the aqueous layer was extracted with CH_2Cl_2 (1×5 mL) and EtOAc (3×5 mL). The combined organic layers were dried (MgSO_4) and concentrated under reduced pressure. Purification of the crude product by flash chromatography (hexanes / EtOAc 1:2) afforded phosphonate (12.0 mg, 30.7 μmol , 86%) as a colorless oil.

$R_f = 0.43$ (hexanes / EtOAc = 1:2); $[\alpha]_D^{22} = -24.5$ ($c = 0.2$, CHCl_3); $^1\text{H-NMR}$ (300 MHz, CDCl_3) $\delta = 0.86$ (d, $J = 6.8$ Hz, 3H), 1.74 (d, $J = 1.1$ Hz, 3H), 3.00 - 3.09 (m, 1H), 3.07 (s, 3H), 3.08 (dd, $J = 22.5, 14.0$ Hz, 1H), 3.36 (dd, $J = 22.5, 14.0$ Hz, 1H), 3.67 (d, $J = 9.9$ Hz, 1H), 3.75 (s, 3H), 3.79 (s, 3H), 6.27 (d, $J = 1.1$ Hz, 1H); $^{13}\text{C-NMR}$ (75 MHz, CDCl_3) $\delta = 13.1, 17.9, 42.2, 43.9, 48.5, 53.0, 56.4, 81.7, 89.3, 145.1, 205.2$; HRMS calculated for $\text{C}_{11}\text{H}_{20}\text{IO}_5\text{PNa}$ $[\text{M}+\text{Na}]^+$: 412.9991, found: 412.9991.

Dimethyl (1*E*,3*S*,4*S*,5*E*)-6-iodo-4-methoxy-3,5-dimethylhexa-1,5-dienylphosphonate 134



$\text{C}_{11}\text{H}_{20}\text{IO}_4\text{P}$
Exact Mass: 374,0144
Mol. Wt.: 374,1523

To a solution of primary alcohol (207 mg, 0.766 mmol, 1.0 eq.) in CH_2Cl_2 (10 mL) at 0 $^\circ\text{C}$ was added *Dess-Martin* periodinane (358 mg, 0.843 mmol, 1.1 eq.). After stirring for 90 min, additional *Dess-Martin* periodinane (75.0 mg, 0.177 mmol, 0.2 eq.) was added. After stirring for further 30 min, the reaction mixture was treated with saturated aqueous $\text{Na}_2\text{S}_2\text{O}_3$ solution (10 mL) and saturated aqueous NaHCO_3 solution (10 mL). The organic layer was separated

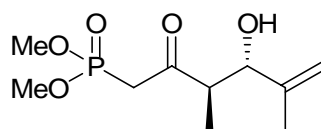
and the aqueous layer was extracted with CH_2Cl_2 (3×10 mL). The combined organic layers were dried (MgSO_4) and concentrated. The crude aldehyde was used in the next step.

In a separate flask, dimethyl methylphosphonate (0.82 mL, 7.66 mmol, 10 eq.) in THF (8 mL) at -50 °C was treated with *n*-BuLi (2.5M in hexane, 2.75 mL, 6.89 mmol, 9.0 eq.). After stirring at -20 °C for 1 h, the mixture was recooled to -78 °C and a solution of the crude aldehyde obtained from the *Dess-Martin* oxidation in THF (1 mL) was added. The reaction mixture was warmed up to 0 °C (c.a. 3 h), and then treated with saturated aqueous NH_4Cl solution (10 mL). The organic layer was separated and the aqueous layer was extracted with EtOAc (4×10 mL). The combined organic layers were dried over MgSO_4 and concentrated under reduced pressure. The crude alcohol was used in the next step.

The crude alcohol was dissolved in CH_2Cl_2 (10 mL), and *Dess-Martin* periodinane (358 mg, 0.843 mmol, 1.1 eq.) was added at r.t. After stirring for 1 h, the reaction mixture was treated with saturated aqueous $\text{Na}_2\text{S}_2\text{O}_3$ solution (10 mL) and saturated aqueous NaHCO_3 solution (10 mL). The organic layer was separated and the aqueous layer was extracted with CH_2Cl_2 (1×10 mL) and EtOAc (3×10 mL). The combined organic layers were dried over MgSO_4 and concentrated under reduced pressure. Purification of the crude product by FC (hexanes / EtOAc = 1:1) afforded the phosphonate (128 mg, 0.342 mmol, 45%, three steps) as a yellowish oil.

$R_f = 0.26$ (hexanes / EtOAc = 1:2); $[\alpha]_D^{22} = +2.48$ ($c = 1.05$, CHCl_3); $^1\text{H-NMR}$ (300 MHz, CDCl_3) $\delta = 0.89$ (d, $J = 7.0$ Hz, 3H), 1.72 (d, $J = 1.1$ Hz, 3H), 2.49 (m, 1H), 3.14 (s, 3H), 3.39 (d, $J = 8.7$ Hz, 1H), 3.68 (d, $J = 0.9$ Hz, 3H), 3.71 (d, $J = 0.9$ Hz, 3H), 5.61 (m, 1H), 6.20 (s, 1H), 6.78 (m, 1H); $^{13}\text{C-NMR}$ (75 MHz, CDCl_3) $\delta = 15.8$, 18.7, 40.8, 41.1, 52.3, 56.7, 80.5, 89.6, 114.3, 116.8, 146.0, 156.3; HRMS calculated for $\text{C}_{13}\text{H}_{23}\text{INO}_4\text{PNa}$ $[\text{M}+\text{CH}_3\text{CN}+\text{Na}]^+$: 438.0307, found: 438.0309.

Dimethyl (3*R*,4*S*)-4-hydroxy-3,5-dimethyl-2-oxohex-5-enylphosphonate 137

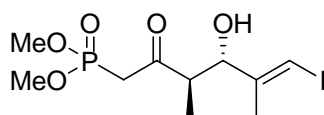


$\text{C}_{10}\text{H}_{19}\text{O}_5\text{P}$
Exact Mass: 250,097
Mol. Wt.: 250,2286

To a cold solution (-78 °C) of dimethyl methylphosphonate (80 μ L, 740 μ mol, 10 eq) in THF (1 mL) were added *n*BuLi (2.5 M in hexane, 300 μ L, 10 eq) and the resulting suspension was stirred at -20 °C for 2 h. To a cold solution (-78 °C) of the ester (50.0 mg, 74.0 μ mol, 1.0 eq) in THF (0.5 mL) was added *i*PrMgCl (2.0 M in Et₂O, 80 μ L, 150 μ mol, 2.0 eq). After 20 min the mixture from on high was added *via* cannula. The reaction mixture was warmed to room temperature and stirred 14 h. Sat. aq. NH₄Cl (1 mL) and H₂O (1 mL) were added, the organic phase separated, and the aq. phase thoroughly extracted with CH₂Cl₂ (4 \times 6 mL). The combined organic phases were dried over MgSO₄ and concentrated under reduced pressure. Silica gel chromatography (hexanes / EtOAc = 1:2) afforded the phosphonate (16.0 mg, 63.9 μ mol, 86%) as a colorless oil.

R_f = 0.10 (hexanes / EtOAc = 1:2); $[\alpha]_D^{20}$ = -34.9 (c = 0.97, CHCl₃); ¹H NMR (300 MHz, CDCl₃) δ = 0.96 (d, J = 7.0 Hz, 3H), 1.73 (s, 3H), 2.77 (d, J = 4.7 Hz, 1H), 3.02 (m, 1H), 3.23 (m, 2H), 3.76 (s, 3H), 3.80 (s, 3H), 4.12 (dd, J = 9.1, 4.2 Hz, 1H), 4.92 (m, 2H); ¹³C NMR (75 MHz, CDCl₃) δ = 13.7, 16.4, 41.1, 42.8, 50.1, 53.1, 79.0, 114.5, 144.4, 206.2; HRMS calculated for C₁₀H₁₉O₅Na [M+Na]⁺: 273.0868, found: 273.0868.

Dimethyl (3*R*,4*S*,*E*)-4-hydroxy-6-iodo-3,5-dimethyl-2-oxohex-5-enylphosphonate 119

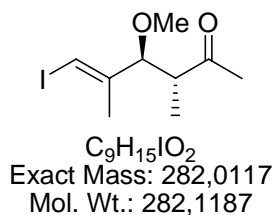


C₁₀H₁₈I O₅P
Exact Mass: 375,9937
Mol. Wt.: 376,1252

To a cold solution (-78 °C) of dimethyl methylphosphonate (156 mL, 2.93 mmol, 11 eq) in THF (1 mL) were added KHMDS (0.5 M in toluene, 2.66 mL, 1.33 mmol, 10 eq) and the resulting suspension was stirred at -20 °C for 2 h. To a cold solution (-78 °C) of the ester (92.1 mg, 0.136 mmol, 1.0 eq) in THF (1 mL) was added *i*PrMgCl (2.0 M in Et₂O, 204 μ L, 0.409 mmol, 3.0 eq). After 20 min the mixture from above was added *via* cannula. The reaction mixture was warmed to -20 °C for ca. 1.5 h and stirred at -20 °C for 0.5 h. Sat. aq. NH₄Cl (6 mL) and H₂O (6 mL) were added, the organic phase separated, and the aq. phase thoroughly extracted with EtOAc (4 \times 6 mL). The combined organic phases were dried over MgSO₄ and concentrated under reduced pressure. Silica gel chromatography (hexanes / EtOAc = 1:2) afforded the phosphonate (40.9 mg, 0.109 μ mol, 80%) as a colorless oil.

$R_f = 0.15$ (hexanes / EtOAc = 1:2); $^1\text{H NMR}$ (300 MHz, CDCl_3) $\delta = 0.93$ (d, $J = 7.0$ Hz, 3H), 1.82 (s, 3H), 3.06 (m, 1H), 3.17 (d, $J = 5.1$ Hz, 1H), 3.25 (d, $J = 4.9$ Hz, 1H), 3.76 (s, 3H), 3.80 (s, 3H), 4.25 (d, $J = 9.2$ Hz, 1H), 6.30 (s, 1H); $^{13}\text{C NMR}$ (75 MHz, CDCl_3) $\delta = 13.7, 18.7, 41.2, 42.9, 50.2, 53.2, 53.3, 79.2, 80.9, 147.4, 205.4, 205.5$.

(E)-(3R,4S)-6-Iodo-4-methoxy-3,5-dimethyl-hex-5-en-2-one 142



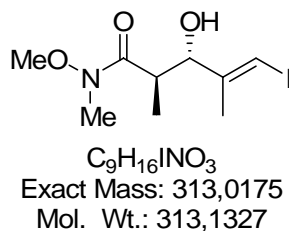
To a cold solution (0 °C) of (E)-(2S,3S)-5-Iodo-3-methoxy-2,4-dimethyl-pent-4-en-1-ol (1.39 g, 5.14 mmol, 1eq) in CH_2Cl_2 (50 mL) were added NaHCO_3 (864 mg, 2 eq) and *Dess-Martin* periodinan (5.02 g, 11.8 mmol, 2.3 eq) and the resulting solution was stirred 4 h at room temperature. Sat. aq. Na_2SO_3 (55 mL) and sat. aq. NaHCO_3 (55 mL) were added, the organic phase separated, and the aq. phase thoroughly extracted with CH_2Cl_2 . The combined organic phases were dried (MgSO_4). Evaporation of the solvent under ambient pressure afforded crude aldehyde (1.37 g, 5.11 mmol), which was used for the next steps without further purification.

To a cold (-78 °C) stirred, solution of crude aldehyde (1.37 g, 5.11 mmol, 1 eq) was added MeMgBr (3.43 mL, 3 M in Et_2O , 10.3 mmol, 2 eq). After 30 min, the reaction mixture was cannulated into cold (0 °C) sat. aq. NH_4Cl (60 mL). The organic phase was separated, and the aq. phase thoroughly extracted with Et_2O . Drying of the combined organic extracts (MgSO_4), evaporation of the solvent gave the respective secondary alcohol (1.45 g, 5.11 mmol), which was directly used in the next step.

To a cold solution (0 °C) of the above prepared secondary alcohol in CH_2Cl_2 (50 mL) were added NaHCO_3 (1.08 g, 12.8 mmol, 2.5 eq) and *Dess-Martin* periodinan (3.27 g, 7.71 mmol, 1.5 eq) and the resulting solution was stirred 90 min at room temperature. Sat. aq. Na_2SO_3 (50 mL) and sat. aq. NaHCO_3 (50 mL) were added, the organic phase separated, and the aq. phase thoroughly extracted with DCM (3×10 mL). The combined organic phases were dried over MgSO_4 . Evaporation of the solvent *in vacuo* and flash chromatography (pentane / $\text{Et}_2\text{O} = 20:1$ to 4:1) afforded the methyl ketone (1.33 g, 4.71 mmol, 92%, over three steps) as a white solid.

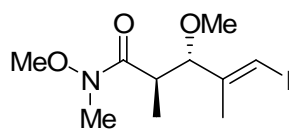
$R_f = 0.17$ (pentane / Et₂O = 4:1); $[\alpha]_D^{20} = +5.9$ ($c = 0.102$, CHCl₃); ¹H NMR (300 MHz, CDCl₃) $\delta = 0.82$ (d, $J = 7.0$ Hz, 3H), 1.73 (d, $J = 1.1$ Hz, 3H), 2.19 (s, 3H), 2.76 (dq, $J = 10.0$, 7.2 Hz, 1H), 3.10 (s, 3H), 3.75 (d, $J = 10.0$ Hz, 1H), 6.27 (d, $J = 1.1$ Hz, 1H); ¹³C NMR (75 MHz, CDCl₃) $\delta = 13.4$, 18.1, 30.5, 48.6, 56.5, 81.2, 88.5, 145.5, 211.1.

(2*R*,3*S*,*E*)-3-hydroxy-5-iodo-*N*-methoxy-*N*,2,4-trimethylpent-4-enamide 139



To a solution of ester (231 mg, 0.342 mmol, 1.0 eq) in THF (1 mL) was added *i*PrMgCl (~2 M in THF, 0.17 mL, 0.34 mmol, 1.0 eq.), after 10 min, a suspension of magnesium chloride methoxy(methyl)amide complex, which was prepared by addition of *i*PrMgCl (~2 M in THF, 3.42 mL, 6.84 mmol, 20 eq.) to a suspension of *N,O*-dimethylhydroxylamine hydrochloride (334 mg, 3.42 mmol, 10 eq.) in THF (3 mL) at -20 °C was added. The reaction mixture was stirred at -20 °C for 2 h and warmed up to -10 °C (1 h). The reaction was quenched by addition of sat. aq. NH₄Cl (5 mL). The product was extracted into EtOAc (3 × 20 mL), and the combined organic layers were dried over MgSO₄, concentrated *in vacuo*. Purification by flash chromatography (hexanes / EtOAc = 2:1 to 1:1) gave the amide (77.0 mg, 0.246 mmol, 72%) as white solid.

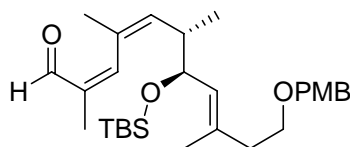
$R_f = 0.15$ (hexanes / EtOAc = 2:1); $[\alpha]_D^{20} = -13.2$ ($c = 1.94$, CHCl₃); ¹H NMR (400 MHz, CDCl₃) $\delta = 1.09$ (d, $J = 7.1$ Hz, 3H), 1.81 (d, $J = 1.0$ Hz, 3H), 3.15 (m, 1H), 3.17 (s, 3H), 3.58 (d, $J = 6.1$ Hz, 1H), 3.69 (s, 3H), 4.26 (t, $J = 6.4$ Hz, 1H), 6.30 (s, 1H); ¹³C NMR (100 MHz, CDCl₃) $\delta = 15.1$, 20.1, 32.2, 38.2, 61.8, 79.0, 80.1, 148.1, 176.3; HRMS calculated for C₁₁H₁₉IN₂O₃Na [M+CH₃CN+Na]⁺: 377.0338, found: 377.0356.

(2*R*,3*S*,*E*)-5-iodo-*N*,3-dimethoxy-*N*,2,4-trimethylpent-4-enamide 140

C₁₀H₁₈INO₃
 Exact Mass: 327,0331
 Mol. Wt.: 327,1593

To a solution of the alcohol (41.0 mg, 0.131 mmol, 1.0 eq.) in Et₂O (0.50 mL) under argon atmosphere were added molecular sieves 4Å (100 mg), Ag₂O (150 mg, 0.647 mmol, 5.0 eq.) and CH₃I (0.20 mL, 3.14 mmol, 24 eq.) subsequently. The resulting mixture was stirred for 72 h at ambient temperature and filtered through cotton afterwards. The solvent was evaporated and the crude product was purified by a short column chromatography on silica gel (hexanes / EtOAc = 2:1) to receive the desired methyl ether (34.2 mg, 0.105 mmol, 80%) as a colorless oil.

$R_f = 0.37$ (hexanes / EtOAc = 2:1); $[\alpha]_D^{20} = -21.4$ ($c = 0.08$, CHCl₃); ¹H NMR (300 MHz, CDCl₃) $\delta = 0.88$ (d, $J = 7.0$ Hz, 3H), 1.74 (d, $J = 1.1$ Hz, 3H), 3.12 (m, 1H), 3.12 (s, 3H), 3.20 (s, 3H), 3.71 (s, 3H), 3.87 (d, $J = 10.2$ Hz, 1H), 6.29 (s, 1H); ¹³C NMR (75 MHz, CDCl₃) $\delta = 14.1, 18.2, 32.1, 37.5, 56.6, 61.5, 81.3, 88.0, 145.7, 175.5$; HRMS calculated for C₁₂H₂₁IN₂O₃Na [M+CH₃CN+Na]⁺: 391.0495, found: 391.0490.

8.3.3 Connection of the C3-C13 and the C14-C19 Subunits**(2*Z*,4*Z*,6*S*,7*S*,8*E*)-7-(*tert*-butyldimethylsilyloxy)-11-(4-methoxybenzyloxy)-2,4,6,9-tetramethylundeca-2,4,8-trienal 143**

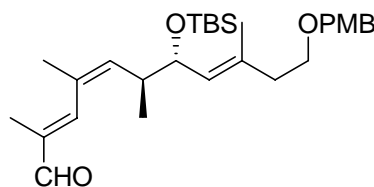
C₂₉H₄₆O₄Si
 Exact Mass: 486,3165
 Mol. Wt.: 486,7586

A solution of the alcohol (161 mg, 0.329 mmol, 1.0 eq.) in CH₂Cl₂ (8 mL) under argon atmosphere was cooled down to 0 °C, before *Dess-Martin* Periodinane (170 mg, 0.400 mmol,

1.2 eq.) was added. The resulting solution was stirred for 60 min at this temperature and quenched by addition of saturated aqueous Na₂SO₃ solution (5 mL) and saturated aqueous NaHCO₃ solution afterwards. The organic layer was separated and the aqueous phase reextracted with CH₂Cl₂ (3 × 15 mL). The combined organic layer was dried (MgSO₄), filtered and the solvent was evaporated. The residue was purified by column chromatography on silica gel (hexanes / EtOAc = 5:1) to give the aldehyde **3** (152 mg, 0.312 mmol, 95%) as colourless liquid.

$R_f = 0.81$ (hexanes / EtOAc = 5:1); $[\alpha]_D^{20} = +33.3$ ($c = 0.94$, CHCl₃); ¹H NMR (400 MHz, CDCl₃): $\delta = -0.06$ (s, 3H), -0.03 (s, 3H), 0.83 (d, $J = 6.8$ Hz, 3H), 0.84 (s, 9H), 1.59 (s, 3H), 1.81 (s, 3H), 1.86 (s, 3H), 2.27 (t, $J = 7.1$ Hz, 2H), 2.33 (m, 1H), 3.50 (t, $J = 7.0$ Hz, 2H), 3.79 (s, 3H), 4.08 (dd, $J = 8.9$ Hz, $J = 6.2$ Hz, 1H), 4.42 (s, 2H), 5.08 (d, $J = 9.0$ Hz, 1H), 5.38 (d, $J = 10.2$ Hz, 1H), 6.86 (d, $J = 8.5$ Hz, 2H), 6.90 (s, 1H), 7.24 (d, $J = 8.7$ Hz, 2H), 9.88 (s, 1H); ¹³C NMR (100 MHz, CDCl₃): $\delta = -4.9$, -4.2 , 15.9 , 16.3 , 17.2 , 18.1 , 25.0 , 25.8 , 39.6 , 40.8 , 55.3 , 68.8 , 72.6 , 73.1 , 113.8 , 129.1 , 129.3 , 130.6 , 133.0 , 136.0 , 136.3 , 147.0 , 159.2 , 193.4 ; HRMS calculated for C₂₉H₄₆NaO₄NaSi: 509.3063, found: 509.3070.

(2E,4Z,8E)-(6S,7S)-7-(tert-Butyl-dimethyl-silanyloxy)-11-(4-methoxy-benzyloxy)-2,4,6,9-tetramethyl-undeca-2,4,8-trienal **145**

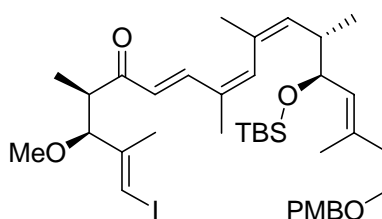


C₂₉H₄₆O₄Si
Exact Mass: 486,3165
Mol. Wt.: 486,7586

To a solution of phosphonate (10.0 mg, 25.6 μ mol) in MeCN (1 mL) at RT was added anhydrous LiCl (1.3 mg, 31 μ mol) and DBU (4.3 μ L, 29 μ mol). After stirring for 10 min, a solution of aldehyde (15.0 mg, 30.8 μ mol) in MeCN (1 mL) was added. After stirring for 24 h, the reaction mixture was treated with saturated aqueous NH₄Cl solution and diluted with EtOAc. The organic layer was separated and the aqueous layer was extracted with EtOAc (3 × 2 mL). The combined organic layers were dried (MgSO₄) and concentrated under reduced pressure. Purification of the crude product by column chromatography (hexanes / EtO₂Ac 9:1) afforded aldehyde as a colorless oil.

$R_f = 0.43$ (hexanes / EtOAc 6:1); $[\alpha]_D^{22} = +25$ ($c = 1.0$, CHCl_3); $^1\text{H-NMR}$ (300 MHz, CDCl_3) δ ppm = -0.06 (s, 3H), -0.03 (s, 3H), 0.82 (s, 9H), 0.89 (d, $J = 7.1$ Hz, 3H), 1.62 (d, $J = 1.0$ Hz, 3H), 1.86 (d, $J = 1.5$ Hz, 3H), 1.98 (d, $J = 1.5$ Hz, 3H), 2.27 (td, $J = 6.7, 2.8$ Hz, 2H), 2.42-2.53 (dq, $J = 10.2, 7.1, 6.6$ Hz, 1H), 3.50 (t, $J = 6.9$ Hz, 2H), 3.8 (s, 3H), 4.11 (dd, $J = 8.9, 6.4$ Hz, 1H), 4.41 (s, 2H), 5.12 (d, $J = 9.2$ Hz, 1H), 5.45 (d, $J = 10.2$ Hz, 1H), 6.85 (d, $J = 8.7$ Hz, 2H), 7.02 (s, 1H), 7.23 (d, $J = 8.7$ Hz, 2H), 9.43 (s, 1H); $^{13}\text{C-NMR}$ (75 MHz, CDCl_3) δ ppm = -4.9, -4.2, 10.8, 16.4, 17.2, 18.1, 23.2, 25.8, 39.6, 40.7, 55.3, 68.8, 72.6, 73.1, 113.8, 129.0, 129.2, 130.6, 131.1, 133.2, 137.6, 140.5, 149.6, 159.2, 196.1; HRMS calculated for $\text{C}_{29}\text{H}_{46}\text{O}_4\text{NaSi}$: 509.3063, found: 509.3063.

(1E,6E,8Z,10Z,14E)-(3S,4R,12S,13S)-13-(tert-Butyl-dimethyl-silyloxy)-1-iodo-3-methoxy-17-(4-methoxy-benzyloxy)-2,4,8,10,12,15-hexamethyl-heptadeca-1,6,8,10,14-pentaen-5-one 144



$\text{C}_{38}\text{H}_{59}\text{I}\text{O}_5\text{Si}$
Exact Mass: 750,3176
Mol. Wt.: 750,862

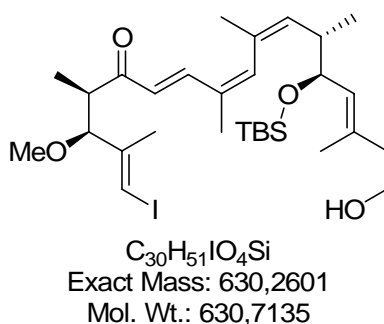
To a cold (0 °C), stirred solution of the methyl ketone (137 mg, 0.487 mmol, 1.0 eq.) in Et_2O (2 mL), that had stirred over powdered 4 Å MS for 30 min, was added NEt_3 (167 μL , 1.19 mmol, 2.4 eq.) followed by $(\text{cHex})_2\text{BCl}$ (213 μL , 1.17 mmol, 2.0 eq). After stirring at 0 °C for 1 h, the reaction mixture was cooled to -78 °C, treated with a solution of the aldehyde (396 mg, 0.814 mmol, 1.7 eq) that had been pre-stirred over 4 Å MS for 1 h. After stirring for 1.5 h, the reaction mixture was warmed to -30 °C, and stirred at this temperature for 15 min. Following this, the reaction mixture was warmed to 0 °C, and treated sequentially with pH7 buffer (8 mL), MeOH (3 mL), and aq. hydrogen peroxide (1.5 mL). After stirring for an additional 1 h, the reaction mixture was treated with brine (20 mL), the organic phase separated, and the aq. phase thoroughly extracted with Et_2O (3×10 mL). The combined organic extracts were dried (MgSO_4), and concentrated *in vacuo*. Purification by flash chromatography (pentane / $\text{Et}_2\text{O} = 100:0$ to 40:10 to 10:10) gave the respective aldol adduct (354 mg, 0.460 mmol, 95%), which was used in the next step.

A solution of the aldol adduct (100 mg, 0.130 mmol, 1.0 eq.) in THF (2 mL), that had pre-stirred over molecular sieves 4Å for 40 min, was treated at RT with Ac₂O (120 μL, 1.30 mmol, 10 eq.) and DMAP (143 mg, 1.17 mmol, 9.0 eq.) and stirred at room temperature for 60 min. DBU (192 μL, 1.30 mmol, 10 eq.) was added. The mixture was stirred for an additional 2 h, then it was diluted with Et₂O and poured into brine. The aqueous layer was separated and extracted with Et₂O (3 × 10 mL). The combined organic extracts were washed with 0.5 N HCl, brine, and dried over MgSO₄. Removal of the solvent *in vacuo* gave an oily residue, which was purified by flash chromatography (petroleum ether/Et₂O = 100:0 to 40:10) to give trienone (91.2 mg, 0.121 μmol, 93%, over 2 steps) as a colourless oil.

$R_f = 0.43$ (hexanes / EtOAc = 6:1); $[\alpha]_D^{22} = +68$ ($c = 1.0$, CHCl₃); ¹H NMR (300 MHz, CDCl₃) $\delta = -0.08$ (s, 3H), -0.05 (s, 3H), 0.82 (s, 9H), 0.84 (d, $J = 6.6$ Hz, 6H), 1.60 (d, $J = 1.0$ Hz, 3H), 1.75 (d, $J = 1.0$ Hz, 3H), 1.82 (s, 3H), 1.90 (d, $J = 1.5$ Hz, 3H), 2.20-2.33 (m, 3H), 3.00 (dq, $J = 9.7, 7.1$ Hz, 1H), 3.07 (s, 3H), 3.49 (t, $J = 7.1$ Hz, 2H), 3.79 (s, 3H), 3.87 (d, $J = 10.2$ Hz, 1H), 4.1 (dd, $J = 8.9, 5.9$ Hz, 1H), 4.41 (s, 2H), 5.09 (d, $J = 10.2$ Hz, 1H), 5.21 (d, $J = 10.2$ Hz, 1H), 6.20 (d, $J = 16.3$ Hz, 1H), 6.24 (s, 1H), 6.28 (s, 1H), 6.85 (d, $J = 8.7$ Hz, 2H), 7.23 (d, $J = 8.7$ Hz, 2H), 7.57 (d, $J = 15.8$ Hz, 1H); ¹³C NMR (75 MHz, CDCl₃) $\delta = -4.9, -4.3, 14.1, 15.7, 17.2, 18.2, 18.2, 19.9, 24.6, 25.9, 29.7, 39.7, 40.7, 46.1, 55.3, 56.6, 69.0, 72.6, 73.0, 81.0, 88.5, 113.8, 126.4, 128.9, 129.2, 130.7, 131.6, 131.8, 132.7, 134.9, 139.3, 141.5, 145.8, 159.2, 202.4$; HRMS calculated for C₃₈H₅₉IO₅NaSiI: 773.3074, found: 773.3074.

8.3.4 Connection of the C3-C19 and the C20-C1'' Subunits

(1E,3S,4R,6E,8Z,10Z,12S,13S,14E)-13-(tert-butyldimethylsilyloxy)-17-hydroxy-1-iodo-3-methoxy-2,4,8,10,12,15-hexamethylheptadeca-1,6,8,10,14-pentaen-5-one 148

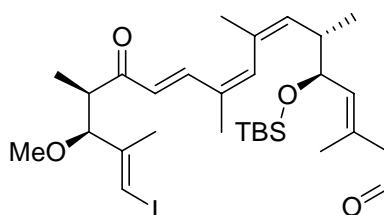


The PMB ether (83.0 mg, 11.0 μmol, 1.0 eq.) was dissolved in CH₂Cl₂ / aq. pH 7 buffer (10:1, 1.1 mL) under argon atmosphere. Then DDQ (75.0 mg, 33.0 μmol, 3.0 eq.) was added fast

and the resulting suspension was stirred for 30 min at ambient temperature. The reaction mixture was quenched by addition of 7 mL saturated, aqueous NaHCO₃ solution. The organic layer was separated and the aqueous phase was extracted with CH₂Cl₂ (3 × 5 mL). Then the combined organic layer was washed with brine (10 mL), dried over MgSO₄, filtered and the solvent was removed under reduced pressure, before the crude product was purified by flash chromatography on silica gel (hexanes / EtOAc = 9:1 to 4:1) to give the desired primary alcohol (65.0 mg, 10.0 μmol, 95%).

$R_f = 0.10$ (hexanes / EtOAc = 9:1); $[\alpha]_D^{20} = +54.3$ ($c = 1.1$, CHCl₃); ¹H NMR (400 MHz, CDCl₃): $\delta = -0.06$ (s, 3H), -0.03 (s, 3H), 0.84 (s, 9H), 0.85 (d, $J = 6.6$ Hz, 3 H), 0.87 (d, $J = 6.6$ Hz, 3H), 1.61 (d, $J = 1.0$ Hz, 3H), 1.76 (d, $J = 1.0$ Hz, 3H), 1.83 (s, 3H), 1.91 (d, $J = 1.0$ Hz, 3H), 2.22 (t, $J = 6.3$ Hz, 2H), 2.25 - 2.35 (m, 1H), 2.95 - 3.06 (m, 1H), 3.08 (s, 3 H), 3.65 (t, $J = 5.1$ Hz, 2H), 3.88 (d, $J = 9.6$ Hz, 1H), 4.10 (dd, $J = 8.6, 5.6$ Hz, 1H), 5.16 (d, $J = 9.2$ Hz, 1H), 5.24 (d, $J = 10.1$ Hz, 1H), 6.21 (d, $J = 15.7$ Hz, 1H), 6.24 (s, 1H), 6.28 (s, 1H), 7.56 (d, $J = 15.7$ Hz, 1H); ¹³C NMR (100 MHz, CDCl₃) $\delta = -4.8, -4.3, 14.1, 15.9, 16.7, 18.1, 18.2, 19.8, 24.6, 25.8, 40.6, 42.7, 46.2, 56.6, 60.5, 72.8, 81.1, 88.4, 126.4, 130.4, 131.7, 131.9, 132.0, 134.2, 139.1, 141.3, 145.8, 202.3$; HRMS calculated for C₃₀H₅₁IO₄NaSi: 653.2499, found: 653.2499.

(3E,5S,6S,7Z,9Z,11E,14R,15S,16E)-5-(tert-butyldimethylsilyloxy)-17-iodo-15-methoxy-3,6,8,10,14,16-hexamethyl-13-oxoheptadeca-3,7,9,11,16-pentaenal 149



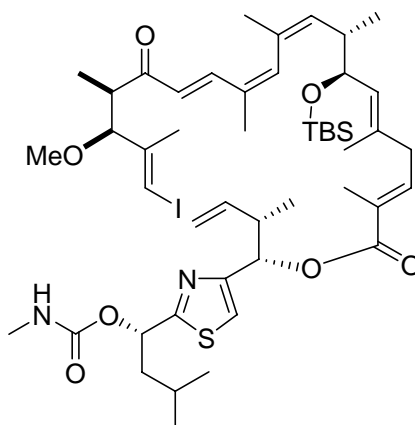
C₃₀H₄₉IO₄Si
Exact Mass: 628,2445
Mol. Wt.: 628,6976

To a solution of oxalyl chloride (19.0 μL, 219 μmol, 7.4 eq.) in DCM (500 μL) mit 4Å MS was added DMSO (30.0 μL, 438 μmol, 15 eq.) at -78 °C. After 20 min stirring of the resulting mixture at the same temperature, a solution of the primary alcohol (18.7 mg, 29.6 μmol, 1.0 eq., pre-stirred over 4Å MS for 0.5 h at RT) in DCM (500 μL) was added slowly. The resulting mixture was stirred for 1 h at -78 °C and Et₃N (39.0 μL, 292 μmol, 10 eq.) was added. After 20 min stirring at -78 °C, the reaction mixture was quenched by addition of 6 mL

saturated, aqueous NH_4Cl solution at $-10\text{ }^\circ\text{C}$. The organic layer was separated and the aqueous phase was extracted with Et_2O ($3 \times 5\text{ mL}$). Then the combined organic layer was washed with brine (5 mL), dried over MgSO_4 , filtered and the solvent was removed under reduced pressure. The crude product was purified by flash chromatography on silica gel (hexanes / $\text{Et}_2\text{OAc} = 4:1$) to give the desired aldehyde (17.5 mg , $27.8\text{ }\mu\text{mol}$, 94%).

$R_f = 0.36$ (hexanes / $\text{EtOAc} = 9:1$); $^1\text{H NMR}$ (300 MHz , CDCl_3): $\delta = -0.06(\text{s}, 3\text{H})$, $-0.03(\text{s}, 3\text{H})$, $0.84(\text{s}, 9\text{H})$, $0.85(\text{d}, J = 7.0\text{ Hz}, 3\text{H})$, $0.88(\text{d}, J = 6.8\text{ Hz}, 3\text{H})$, $1.65(\text{d}, J = 1.3\text{ Hz}, 3\text{H})$, $1.75(\text{d}, J = 1.1\text{ Hz}, 3\text{H})$, $1.83(\text{s}, 3\text{H})$, $1.91(\text{d}, J = 1.3\text{ Hz}, 3\text{H})$, $2.30(\text{m}, 1\text{H})$, $3.01(\text{m}, 3\text{H})$, $3.08(\text{s}, 3\text{H})$, $3.87(\text{d}, J = 9.8\text{ Hz}, 1\text{H})$, $4.11(\text{dd}, J = 8.8, 5.6\text{ Hz}, 1\text{H})$, $5.24(\text{m}, 2\text{H})$, $6.21(\text{d}, J = 15.3\text{ Hz}, 1\text{H})$, $6.23(\text{s}, 1\text{H})$, $6.28(\text{s}, 1\text{H})$, $7.55(\text{d}, J = 15.4\text{ Hz}, 1\text{H})$, $9.58(\text{t}, J = 2.4\text{ Hz}, 1\text{H})$; $^{13}\text{C NMR}$ (75 MHz , CDCl_3) $\delta = -4.5, -4.0, 14.4, 16.1, 18.1, 18.6, 20.2, 24.9, 26.1, 40.9, 46.7, 54.6, 57.0, 73.1, 81.4, 88.8, 126.8, 127.1, 132.4, 133.8, 134.2, 139.4, 141.6, 146.1, 200.1, 202.6$; HRMS calculated for $\text{C}_{30}\text{H}_{49}\text{IO}_4\text{NaSi}$: 651.2343 , found: 651.2349 .

(2E,5E,7S,8S,9Z,11Z,13E,16R,17S,18E)-((1S,2S)-2-methyl-1-(2-((S)-3-methyl-1-(methylcarbamoyloxy)butyl)thiazol-4-yl)but-3-enyl) 7-(tert-butyldimethylsilyloxy)-19-iodo-17-methoxy-2,5,8,10,12,16,18-heptamethyl-15-oxononadeca-2,5,9,11,13,18-hexaenoate 151



$\text{C}_{48}\text{H}_{75}\text{IN}_2\text{O}_7\text{SSi}$
Exact Mass: $978,4109$
Mol. Wt.: $979,1733$

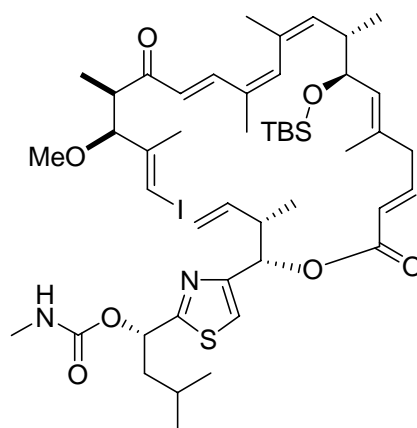
To NaH ($55\text{-}65\%$ in mineral oil, 1.2 mg , $30.0\text{ }\mu\text{mol}$, 1.1 eq.) was added a solution of the phosphonate (18.4 mg , $36.5\text{ }\mu\text{mol}$, 1.3 eq.) in THF ($200\text{ }\mu\text{L}$) at $0\text{ }^\circ\text{C}$. After 30 min stirring at $0\text{ }^\circ\text{C}$, the resulting suspension was cooled at $-20\text{ }^\circ\text{C}$ and a solution of the aldehyde (17.5 mg , $27.8\text{ }\mu\text{mol}$, 1.0 eq.) in THF ($200\text{ }\mu\text{L}$) was added. The reaction mixture was warmed to room

temperature, stirred for 4 h and quenched by addition of 2 mL saturated, aqueous NH_4Cl solution. The organic layer was separated and the aqueous phase was extracted with EtOAc (4×5 mL). Then the combined organic layer was dried over MgSO_4 , filtered and the solvent was removed under reduced pressure. The crude product was purified by flash chromatography on silica gel (hexanes / Et₂OAc = 4:1) to give the desired ester (5.5 mg, 5.6 μmol , 20%).

$R_f = 0.22$ (hexanes / EtOAc = 6:1); $[\alpha]_D^{20} = +49.7$ ($c = 0.27$, CHCl_3); $^1\text{H NMR}$ (600 MHz, CDCl_3): $\delta = -0.05$ (s, 3H), -0.03 (s, 3H), 0.89 (s, 9H), 0.90 (d, $J = 7.1$ Hz, 3 H), 0.92 (d, $J = 7.0$ Hz, 3H), 1.00 (d, $J = 6.6$ Hz, 3H), 1.01 (d, $J = 7.0$ Hz, 3H), 1.02 (d, $J = 7.3$ Hz, 3H), 1.70 (s, 3H), 1.78 (m, 1H), 1.79 (s, 3H), 1.85 (s, 3H), 1.90 (m, 2H), 1.90 (s, 3H), 1.97 (s, 3H), 2.34 (m, 1H), 2.75 (s, 3H), 2.93 (t, $J = 7.5$ Hz, 2H), 3.00 (m, 1H), 3.07 (m, 1H), 3.11 (s, 3H), 3.93 (d, $J = 9.9$ Hz, 1H), 4.22 (dd, $J = 8.8, 5.5$ Hz, 1H), 5.05 (m, 2H), 5.16 (d, $J = 8.8$ Hz, 1H), 5.30 (d, $J = 10.3$ Hz, 1H), 5.81 (m, 1H), 5.86 (d, $J = 7.0$ Hz, 1H), 6.03 (m, 1H), 6.30 (s, 1H), 6.40 (d, $J = 15.4$ Hz, 1H), 6.50 (s, 1H), 6.90 (t, $J = 7.7$ Hz, 1H), 7.33 (s, 1H), 7.60 (d, $J = 15.8$ Hz, 1H); $^{13}\text{C NMR}$ (75 MHz, CDCl_3) $\delta = -4.5, -4.0, 12.6, 14.2, 16.0, 17.0, 17.7, 18.5, 19.0, 19.8, 22.4, 23.4, 24.7, 25.8, 26.4, 27.5, 39.3, 42.0, 43.5, 45.9, 47.9, 56.8, 73.3, 74.2, 76.6, 82.1, 89.7, 116.4, 117.8, 127.2, 128.1, 129.9, 133.3, 133.5, 134.2, 134.8, 140.6, 141.5, 142.5, 146.7, 155.5, 158.2, 168.4, 173.8, 204.5$; HRMS calculated for $\text{C}_{48}\text{H}_{76}\text{IN}_2\text{O}_7\text{SSi}$: 979.4187, found: 979.4167.

8.3.5 Heck-Macrocyclisation: Towards Archazolid B

(2E,5E,7S,8S,9Z,11Z,13E,16R,17S,18E)-((1S,2S)-2-methyl-1-(2-((S)-3-methyl-1-(methyl carbamoyloxy)butyl)thiazol-4-yl)but-3-enyl) 7-(tert-butyldimethylsilyloxy)-19-iodo-17-methoxy-5,8,10,12,16,18-hexamethyl-15-oxonadeca-2,5,9,11,13,18-hexaenoate 158



C₄₇H₇₃IN₂O₇SSi
 Exact Mass: 964,3952
 Mol. Wt.: 965,1467

To NaH (55-65% in mineral oil, 1.4 mg, 35.5 μ mol, 1.3 eq.) was added a solution of the phosphonate (13.7 mg, 27.9 μ mol, 1.0 eq.) in THF (200 μ L) at 0 °C. After 30 min stirring at 0 °C, the resulting suspension was cooled at -20 °C and a solution of the aldehyde (26.7 mg, 42.5 μ mol, 1.5 eq.) in THF (200 μ L) was added. The reaction mixture was stirred at -20 °C for 30 min and quenched by addition of 2 mL saturated, aqueous NH₄Cl solution. The organic layer was separated and the aqueous phase was extracted with EtOAc (4 \times 5 mL). Then the combined organic layer was dried over MgSO₄, filtered and the solvent was removed under reduced pressure. The crude product was purified by flash chromatography on silica gel (hexanes / Et₂OAc = 4:1) to give the desired este (17.8 mg, 18.4 μ mol, 66%).

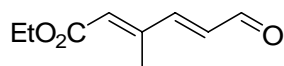
R_f = 0.32 (hexanes / EtOAc = 6:1); $[\alpha]_D^{20}$ = +22.3 (c = 0.35, CHCl₃); ¹H NMR (600 MHz, CDCl₃): δ = 0.008 (s, 3H), 0.04 (s, 3H), 0.89 (d, J = 7.0 Hz, 3 H), 0.90 (s, 9H), 0.94 (d, J = 7.0 Hz, 3H), 0.98 (d, J = 6.6 Hz, 3H), 1.01 (d, J = 7.0 Hz, 3H), 1.02 (d, J = 7.0 Hz, 3H), 1.68 (s, 3H), 1.78 (m, 1H), 1.80 (s, 3H), 1.85 (s, 3H), 1.92 (m, 2H), 1.97 (s, 3H), 2.34 (m, 1H), 2.75 (s, 3H), 2.92 (t, J = 7.0 Hz, 2H), 2.98 (m, 1H), 3.07 (m, 1H), 3.11 (s, 3H), 3.93 (d, J = 9.9 Hz, 1H), 4.22 (dd, J = 9.0, 5.3 Hz, 1H), 5.05 (m, 2H), 5.20 (dd, J = 8.8, 1.1 Hz, 1H), 5.30 (d, J = 9.9 Hz, 1H), 5.80 (m, 1H), 5.86 (d, J = 7.3 Hz, 1H), 5.93 (d, J = 15.8 Hz, 1H); 6.03 (dd, J = 9.2, 4.8 Hz, 1H); 6.32 (s, 1H), 6.39 (d, J = 15.8 Hz, 1H), 6.50 (s, 1H), 7.01 (m, 1H), 7.36 (s, 1H), 7.60 (d, J = 15.8 Hz, 1H); ¹³C NMR (600 MHz, CDCl₃) δ = -4.5, -4.0, 14.2, 16.0, 16.8, 17.4, 18.5, 19.0, 19.7, 22.4, 23.4, 24.7, 25.8, 26.4, 27.5, 41.9, 43.0, 43.4, 45.9, 47.9, 56.8, 73.3, 74.2, 76.2, 82.1, 89.7, 116.4, 118.0, 123.1, 127.2, 131.1, 133.4, 133.5, 133.6, 134.6, 140.6, 142.5, 146.7, 149.0, 155.5, 158.3, 167.0, 173.9, 204.5; HRMS calculated for C₄₇H₇₃IN₂O₇NaSSi: 987.3850, found: 987.3857.

8.4 Studies Towards the Total Synthesis of Etnangien

8.4.1 Synthesis of the C15-C23 Subunit

8.4.1.1 Synthesis of the Aldehyde Fragment – Wittig Reaction

(2*E*,4*E*)-ethyl 3-methyl-6-oxohexa-2,4-dienoate 191



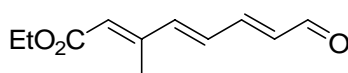
C₉H₁₂O₃
Exact Mass: 168,0786
Mol. Wt.: 168,1898

1. (*E*)-Ethyl 3-methyl-4-oxobut-2-enoate (1.0 g, 7.03 mmol, 1.0 eq.) was added to a suspension of Ph₃PCHCHO (3.20 g, 10.5 mmol, 1.5 eq.) in dry CH₂Cl₂ (4 mL). The reaction mixture was stirred for 24 h at room temperature and purified direct by flash chromatography (hexanes / Et₂O = 6:1 to 2:1) to give the aldehyde (831 mg, 4.94 mmol, 70%) as white needle crystals.

2. A flask containing Ph₃PCHCHO (146 mg, 0.481 mmol, 1.0 eq.) was added a solution of (*E*)-Ethyl 3-methyl-4-oxobut-2-enoate (207 μL, 1.52 mmol, 3.0 eq.) in abs. DCM (100 μL). The reaction mixture was stirred for 15 h at room temperature and purified direct by flash chromatography (hexanes / Et₂O = 6:1 to 1:1) to give the aldehyde (64.6 mg, 0.384 mmol, 80%) as white needle crystals.

R_f = 0.37 (hexanes / EtOAc = 9:1); ¹H NMR (300 MHz, CDCl₃) δ = 1.29 (t, *J* = 7.2 Hz, 3H), 2.29 (s, 3H), 4.20 (q, *J* = 7.2 Hz, 2H), 6.11 (s, 1H), 6.43 (dd, *J* = 15.6, 7.4 Hz, 1H), 7.08 (d, *J* = 15.6 Hz, 1H), 9.65 (d, *J* = 7.5 Hz, 1H); ¹³C NMR (75 MHz, CDCl₃) δ = 13.8, 14.2, 60.5, 127.0, 132.7, 148.6, 154.2, 165.8, 193.3.

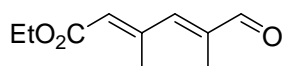
Byproduct: (2*E*,4*E*,6*E*)-ethyl 3-methyl-8-oxoocta-2,4,6-trienoate 192



C₁₁H₁₄O₃
Exact Mass: 194,0943
Mol. Wt.: 194,2271

$R_f = 0.37$ (hexanes / EtOAc = 9:1); $^1\text{H NMR}$ (300 MHz, CDCl_3) $\delta = 1.28$ (t, $J = 7.2$ Hz, 3H), 2.31 (s, 3H), 4.18 (q, $J = 7.0$ Hz, 2H), 6.94 (s, 1H), 6.26 (dd, $J = 15.3, 7.7$ Hz, 1H), 6.65 (d, $J = 15.4$, 1H), 6.74 (dd, $J = 15.3, 10.4$ Hz, 1H), 7.16 (dd, $J = 15.3, 10.4$ Hz, 1H), 9.60 (d, $J = 7.9$ Hz, 1H); $^{13}\text{C NMR}$ (75 MHz, CDCl_3) $\delta = 13.6, 14.3, 60.2, 123.9, 131.1, 133.5, 144.8, 150.0, 150.4, 166.4, 193.3$.

(2E,4E)-ethyl 3,5-dimethyl-6-oxohexa-2,4-dienoate 194

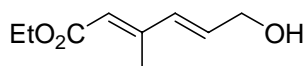


$\text{C}_{10}\text{H}_{14}\text{O}_3$
Exact Mass: 182,0943
Mol Wt.: 182,2164

A flask containing $\text{Ph}_3\text{PC}(\text{CH}_3)\text{CHO}$ (50.0 mg, 0.157 mmol, 1.0 eq.) was added a solution of (*E*)-Ethyl 3-methyl-4-oxobut-2-enoate (64.0 μL , 0.471 mmol, 3.0 eq.) in abs. DCM (40 μL). The reaction mixture was stirred for 28 h at room temperature and purified direct by flash chromatography (hexanes / $\text{Et}_2\text{O} = 9:1$ to 4:1) to give aldehyde (17.8 mg, 97.7 μmol , 62%) as yellow crystals.

$R_f = 0.24$ (hexanes / $\text{Et}_2\text{O} = 9:1$); $^1\text{H NMR}$ (400 MHz, CDCl_3) $\delta = 1.29$ (t, $J = 7.1$ Hz, 3H), 1.94 (s, 3H), 2.37 (d, $J = 1.5$ Hz, 3H), 4.19 (q, $J = 7.1$ Hz, 2H), 5.94 (s, 1H), 6.73 (s, 1H), 9.46 (s, 1H); $^{13}\text{C NMR}$ (75 MHz, CDCl_3) $\delta = 11.1, 14.2, 18.4, 60.3, 123.0, 140.4, 150.1, 150.9, 166.0, 195.1$.

(2E,4E)-ethyl 6-hydroxy-3-methylhexa-2,4-dienoate 197



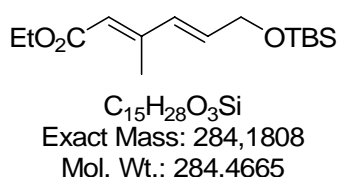
$\text{C}_9\text{H}_{14}\text{O}_3$
Exact Mass: 170,0943
Mol. Wt.: 170,2057

A solution of sodium borohydride (242 mg, 6.4 mmol, 0.5 eq.) in $\text{EtOH}/\text{H}_2\text{O}$ (1:1, 3 mL) was added to a solution of (*2E,4E*)-ethyl 3-methyl-6-oxohexa-2,4-dienoate (2.15 g, 12.8 mmol) in $\text{EtOH}/\text{H}_2\text{O}$ (1:1, 2 mL) at 0 $^\circ\text{C}$. The reaction mixture was stirred at RT for 20 min, saturated with NaCl and extracted with Et_2O (5 x 20 mL). The combined organic extracts were dried

over MgSO_4 . Evaporation of the solvent *in vacuo* afforded crude alcohol (3.12 g), which was used for the next steps without further purification.

$R_f = 0.41$ (hexanes / EtOAc = 2:1); $^1\text{H NMR}$ (400 MHz, CDCl_3) $\delta = 1.27$ (t, $J = 7.1$ Hz, 3H), 2.26 (s, 3H), 4.15 (q, $J = 7.1$ Hz, 2H), 4.28 (t, $J = 4.8$, 2H), 5.76 (s, 1H), 6.20 (dt, $J = 15.8$, 5.1 Hz, 1H), 6.31 (d, $J = 15.8$ Hz, 1H); $^{13}\text{C NMR}$ (100 MHz, CDCl_3) $\delta = 13.4$, 14.3, 59.8, 63.1, 119.7, 133.7, 134.5, 151.4, 167.1.

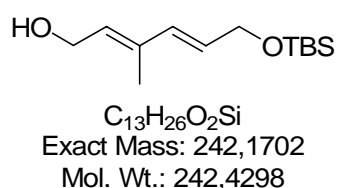
(2E,4E)-Ethyl 6-(tert-butyldimethylsilyloxy)-3-methylhexa-2,4-dienoate 198



To a solution of the crude alcohol (3.12 g) and imidazol (1.13 g, 16.6 mmol, 1.3 eq.) in abs. DMF (2 mL) was added slowly a solution of TBSCl (2.51 g, 16.6 mmol, 1.3 eq.) in abs. DMF (5ml). The reaction mixture was stirred at RT for 30 min. Sat. aq. NaHCO_3 (25 mL) were added, the organic phase separated, and the aq. phase thoroughly extracted with Et_2O (4×40 mL). The combined organic extracts were dried over MgSO_4 and concentrated *in vacuo*. Purified by flash chromatography (hexanes / $\text{Et}_2\text{O} = 9:1$) gave TBS-ether (3.25 g, 11.4 mmol, 89%, two steps) as colourless oil.

$R_f = 0.43$ (hexanes / $\text{Et}_2\text{O} = 9:1$); $^1\text{H NMR}$ (300 MHz, CDCl_3) $\delta = 0.07$ (s, 6H), 0.91 (s, 9H), 1.27 (t, $J = 7.2$ Hz, 3H), 2.27 (d, $J = 1.5$ Hz, 3H), 4.15 (q, $J = 7.1$ Hz, 2H), 4.30 (dd, $J = 4.6$, 1.5 Hz, 2H), 5.75 (s, 1H), 6.14 (dt, $J = 15.8$, 4.6 Hz, 1H), 6.31 (d, $J = 15.8$ Hz, 1H); $^{13}\text{C NMR}$ (75 MHz, CDCl_3) $\delta = -5.2$, 13.9, 14.3, 18.4, 25.9, 59.7, 63.3, 119.0, 132.4, 135.2, 151.8, 167.1; LC-MS (ESI) calculated for $\text{C}_{15}\text{H}_{28}\text{O}_3\text{Si}$: 284.1808, found: 284.0.

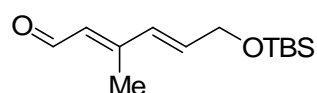
(2E,4E)-6-(tert-butyldimethylsilyloxy)-3-methylhexa-2,4-dien-1-ol



To a cooled (0 °C) solution of the ester (3.44 g, 12.1 mmol, 1.0 eq.) in THF (50 mL) was added slowly DIBAL-H (1.0 M in hexane, 36.3 mL, 36.3 mmol, 3.0 eq.) in a period of 15 min. The reaction mixture was stirred at 0 °C for 1 h and 200 mL H₂O were added. The organic phase was separated, and the aq. phase extracted with Et₂O (6 × 40 mL). The combined organics were dried over MgSO₄, filtered and evaporated *in vacuo*. Silica gel chromatography (hexanes / Et₂O, gradient elution, 1:1 to 1:2) afforded alcohol (2.85 g, 11.8 mmol, 97%) as a colorless oil.

R_f = 0.29 (hexanes / Et₂O = 6:1); ¹H NMR (300 MHz, CDCl₃) δ = 0.06 (s, 6H), 0.90 (s, 9H), 1.78 (s, 3H), 4.24 (d, J = 4.7 Hz, 4H), 5.62 (t, J = 6.6 Hz, 1H), 5.75 (dt, J = 15.6, 5.1 Hz, 1H), 6.24 (d, J = 15.6 Hz, 1H); ¹³C NMR (75 MHz, CDCl₃) δ = -5.2, 12.6, 18.4, 26.0, 59.4, 63.8, 128.6, 129.6, 133.7, 135.8.

(2E,4E)-6-(tert-butyldimethylsilyloxy)-3-methylhexa-2,4-dienal 188



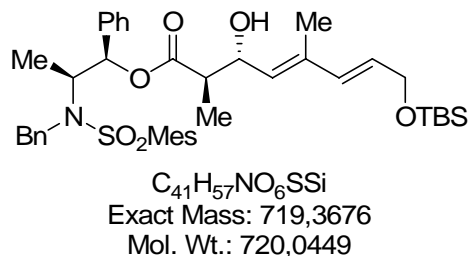
C₁₃H₂₄O₂Si
Exact Mass: 240,1546
Mol. Wt.: 240,414

To a stirred solution of the alcohol (2.80 g, 11.5 mmol, 1.0 eq.) in Et₂O (10 mL) was added 4 Å MS (7 g) and MnO₂ (15.1 g, 173 mmol, 15 eq.) in portions at 0 °C. The resulting suspension was stirred at room temperature for 30 min. Then the suspension was filtered through Celite and Silica gel which were washed with Et₂O (10 × 50 mL). The solvent of the filtrate was removed to give aldehyde in 95% yield (2.63 g, 10.9 mmol) as yellow oil, which was used for the next step without further purification.

R_f = 0.51 (hexanes / EtOAc = 6:1); ¹H NMR (300 MHz, CDCl₃) δ = 0.07 (s, 6H), 0.90 (s, 9H), 2.24 (s, 3H), 4.32 (dd, J = 4.0, 1.4 Hz, 2H), 5.92 (d, J = 8.1 Hz, 1H), 6.30 (dt, J = 15.6, 4.1 Hz, 1H), 6.42 (d, J = 15.6 Hz, 1H), 10.09 (d, J = 8.1 Hz, 1H); ¹³C NMR (75 MHz, CDCl₃) δ = -5.3, 13.2, 18.4, 25.9, 63.2, 129.4, 131.9, 137.2, 154.0, 191.4.

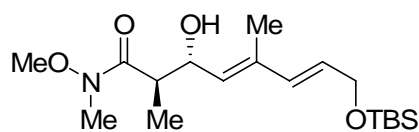
8.4.1.2 Construction of the Stereocentres at C20 and C21

(2*R*,3*R*,4*E*,6*E*)-((1*R*,2*S*)-2-(*N*-benzyl-2,4,6-trimethylphenylsulfonamido)-1-phenylpropyl) 8-(*tert*-butyldimethylsilyloxy)-3-hydroxy-2,5-dimethylocta-4,6-dienoate **199**



A solution of (1*R*,2*S*)-2-(*N*-benzyl-2,4,6-trimethylphenyl-sulfonamido)-1-phenylpropyl propionate (356 mg, 0.742 mmol, 1 eq.) and Et₃N (0.260 mL, 1.86 mmol, 2.5 eq.) in CH₂Cl₂ (2.5 mL) under argon atmosphere was cooled down to -78 °C. Then dicyclohexyl-(trifluoromethylsulfonyloxy)borane (1.63 mL, 1M in *n*-Hexane, 1.63 mmol, 2.2 eq.) was added slowly. The resulting mixture was stirred for 2h at -78 °C, before a solution of aldehyde (360 mg, 1.48 mmol, 2.0 eq.) in 6 mL CH₂Cl₂ (dried with 4Å molecular sieves) was added slowly. After further 1h the reaction mixture was warmed up to -40 °C (1h), quenched with pH7 buffer (3.5 mL), diluted with MeOH (14 mL) and charged with 2 mL of a 30% H₂O₂ solution, before the mixture was stirred at r.t. overnight. Afterwards, the solvent was removed in vacuo and the residue was dissolved in CH₂Cl₂ (15 mL). The organic layer was washed with H₂O, separated and the aqueous phase was reextracted with CH₂Cl₂ (3 × 10 mL). The combined organic layer was dried over Na₂SO₄, filtered and the solvent was removed in vacuo. The residue was purified by column chromatography (hexanes / EtOAc = 8:1) to give ester as white crystals (408 mg, 0.567 mmol, 76%, d.r. > 5:1).

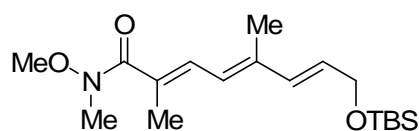
$R_f = 0.31$ (hexanes / EtOAc = 6:1); $[\alpha]_D^{20} = +41.6$ ($c = 0.88$, CHCl₃); ¹H NMR (300 MHz, CDCl₃) $\delta = 0.07$ (s, 6H), 0.91 (s, 9H), 1.03 (d, $J = 7.2$ Hz, 3H), 1.16 (d, $J = 7.0$ Hz, 3H), 1.78 (s, 3H), 2.27 (s, 3H), 2.43 (m, 1H), 2.50 (s, 6H), 4.09 (m, 1H), 4.24 (dd, $J = 5.1, 0.9$ Hz, 2H), 4.57 (dd, $J = 8.5, 4.0$ Hz, 1H), 4.57 (A of ABq, $J_{AB} = 16.5$, 1H), 4.78 (B of ABq, $J_{AB} = 16.5$, 1H), 5.36 (d, $J = 9.2$ Hz, 1H), 5.76 (dt, $J = 15.2, 5.1$ Hz, 1H), 5.84 (d, $J = 4.0$ Hz, 1H), 6.24 (d, $J = 15.4$ Hz, 1H), 6.85 (m, 4H), 7.19 (m, 6H), 7.30 (m, 2H); ¹³C NMR (75 MHz, CDCl₃) $\delta = -5.2, 13.3, 13.8, 18.4, 20.9, 22.9, 26.0, 46.3, 48.3, 56.9, 63.7, 70.2, 78.3, 125.9, 126.1, 127.1, 127.5, 127.6, 127.9, 128.3, 128.4, 129.3, 130.4, 132.1, 133.4, 133.5, 137.0, 138.3, 138.7, 140.3, 142.5, 174.3$; HRMS calculated for C₄₁H₅₇NO₆SSiNa [M+Na]⁺: 742.3574, found: 742.3574.

(2R,3R,4E,6E)-8-(tert-butyldimethylsilyloxy)-3-hydroxy-N-methoxy-N,2,5-trimethylocta-4,6-dienamide 201

$C_{18}H_{35}NO_4Si$
Exact Mass: 357,2335
Mol. Wt.: 357,5603

To a stirred suspension (-20 °C) of *O,N*-dimethylhydroxylamine hydrochloride (55.8 mg, 572 μ mol, 20.0 eq.) in THF (100 μ L) was added *i*PrMgCl (~2 M in THF, 587 μ L, 1173 μ mol, 41.0 eq). The mixture was stirred at -20 °C for 20 min and then a solution of ester (20.6 mg, 28.6 μ mol, 1.0 eq.) in THF (100 μ L + 2 \times 100 μ L washings) was added. The reaction mixture was warmed to -10 °C for 2.5 h and stirred at 0 °C for 2 h, quenching with sat. aq. NH_4Cl (5 mL). The organic layer was separated and the aqueous layer was extracted with CH_2Cl_2 (3 \times 10 mL) and the combined organic extracts washed with brine (20 mL), dried ($MgSO_4$) and concentrated *in vacuo*. Silica gel chromatography (hexanes / EtOAc, gradient elution, 9:1 to 1:1) afforded amide (5.30 mg, 14.8 μ mol, 52%) as a colorless oil.

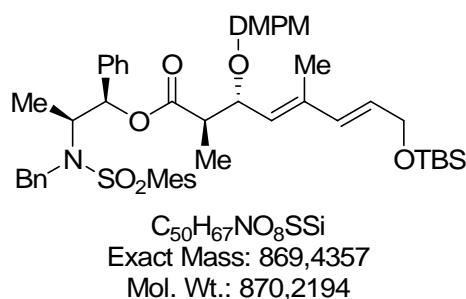
R_f = 0.12 (hexanes / EtOAc = 1:1); $[\alpha]_D^{20}$ = -13.0 (c = 0.83, $CHCl_3$); 1H NMR (400 MHz, $CDCl_3$) δ = 0.06 (s, 6H), 0.90 (s, 9H), 1.11 (d, J = 7.1, 3H), 1.82 (s, 3H), 2.94 (m, 1H), 3.04 (d, J = 5.6, 1H), 3.20 (s, 3H), 3.68 (s, 3H), 4.24 (d, J = 5.1, 2H), 4.60 (dd, J = 7.6, 7.2, 1H), 5.43 (d, J = 9.2, 1H), 5.75 (dt, J = 15.3, 5.1, 1H), 6.24 (d, J = 15.3, 1H); ^{13}C NMR (100 MHz, $CDCl_3$) δ = -5.1, 13.2, 14.4, 18.5, 26.0, 41.5, 61.5, 63.8, 70.7, 128.7, 131.8, 133.7, 136.0, 189.2; HRMS calculated for $C_{18}H_{35}NO_4SiNa$ $[M+Na]^+$: 380.2233, found: 380.2232.

(2E,4E,6E)-8-(tert-butyldimethylsilyloxy)-N-methoxy-N,2,5-trimethylocta-2,4,6-trienamide 202

$C_{18}H_{33}NO_3Si$
Exact Mass: 339,223
Mol. Wt.: 339,545

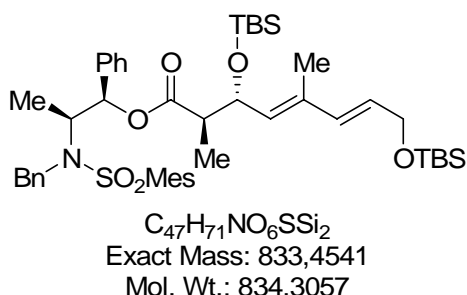
R_f = 0.31 (hexanes / EtOAc = 4:1); $^1\text{H NMR}$ (400 MHz, CDCl_3) δ = 0.08 (s, 6H), 0.91 (s, 9H), 1.90 (s, 3H), 2.00 (s, 3H), 3.23 (s, 3H), 3.63 (s, 3H), 4.28 (dd, J = 5.1, 1.0 Hz, 1H), 5.87 (dt, J = 15.5, 5.2 Hz, 1H), 6.24 (d, J = 11.9 Hz, 1H), 6.36 (d, J = 15.5, 1H), 6.83 (dd, J = 11.8 Hz, 1.4, 1H); $^{13}\text{C NMR}$ (100 MHz, CDCl_3) δ = -5.1, 13.0, 14.4, 18.5, 26.0, 33.7, 61.0, 64.0, 125.1, 128.9, 130.0, 131.0, 134.1, 138.9, 173.0; HRMS calculated for $\text{C}_{18}\text{H}_{34}\text{NO}_3\text{Si}$ $[\text{M}+\text{H}]^+$: 340.2308, found: 340.2306.

(2R,3R,4E,6E)-((1R,2S)-2-(N-benzyl-2,4,6-trimethylphenylsulfonamido)-1-phenylpropyl) 8-(tert-butyldimethylsilyloxy)-3-(3,4-dimethoxybenzyloxy)-2,5-dimethylocta-4,6-dienoate
205



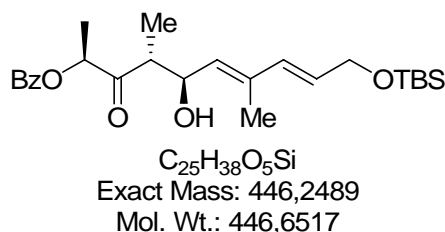
To a solution of the alcohol (47.5 mg, 66.0 μmol , 1.0 eq.) and PPTS (8.30 mg, 33.0 μmol , 0.5 eq.) in abs. DCM (0.50 mL) was added a solution of imidate (41.3 mg, 132 μmol , 2.0 eq.) in abs. DCM (0.50 mL). The reaction mixture was stirred at RT for 17 h. PPTS (8.30 mg, 33.0 μmol , 0.5 eq.) and a solution of imidate (41.3 mg, 132 μmol , 2.0 eq.) in abs. DCM (0.50 mL) was added. After 4 h stirring at room temperature, sat. aq. NaHCO_3 (2 mL) were added, the organic phase separated, and the aq. phase extracted with DCM (3×4 mL). The combined organic extracts were dried over MgSO_4 and concentrated *in vacuo*. LC-MC showed that the yield of the DMPM-ether was 47%. The DMPM-ether couldn't be purified by column chromatography on silica gel. LC-MS calculated for $\text{C}_{50}\text{H}_{67}\text{NO}_8\text{SSiNH}_4$ $[\text{M}+\text{NH}_4]^+$: 887.46, found: 887.50.

(2R,3R,4E,6E)-((1R,2S)-2-(N-benzyl-2,4,6-trimethylphenylsulfonamido)-1-phenylpropyl) 3,8-bis(tert-butyldimethylsilyloxy)-2,5-dimethylocta-4,6-dienoate 206



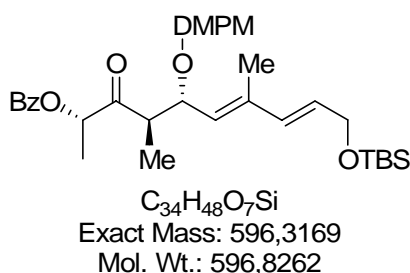
To a stirred solution (-78 °C) of alcohol (86.4 mg, 0.120, mmol, 1.0 eq.) in CH_2Cl_2 (1 mL) was added 2,6-lutidine (24 μ L, 0.203 mmol, 1.7 eq.) and TBSOTf (36 μ L, 0.203 mmol, 1.7 eq.). The mixture was stirred at -78 °C for 60 min. The cooling bath was removed and the reaction quenched with sat. aqueous $NaHCO_3$ (2 mL). The mixture was warmed to room temperature. CH_2Cl_2 (10 mL) were added. The organic layer was separated and the aqueous layer was extracted with CH_2Cl_2 (3 \times 5 mL). The combined organics were washed with sat. aqueous $NaHCO_3$ (3 mL), dried over $MgSO_4$, filtered and evaporated *in vacuo*. Silica gel chromatography (hexanes / EtOAc 9:1) afforded the desired TBS-ether (97.2 mg, 0.116 mmol, 98%) as a white solid.

$R_f = 0.59$ (hexanes / EtOAc = 9:1); $[\alpha]_D^{20} = (c =, CHCl_3)$; 1H NMR (300 MHz, $CDCl_3$) $\delta = -0.06$ (s, 3H), -0.03 (s, 3H), 0.07 (s, 6H), 0.80 (s, 9H), 0.88 (d, $J = 7.2$ Hz, 3H), 0.91 (s, 9H), 1.14 (d, $J = 7.0$ Hz, 3H), 1.64 (d, $J = 0.9$ Hz, 3H), 2.29 (s, 3H), 2.42 (s, 1H), 2.49 (m, 1H), 4.02 (m, 1H), 4.23 (dd, $J = 5.2, 1.2$ Hz, 2H), 4.45 (A of ABq, $J_{AB} = 16.2$, 1H), 4.63 (dd, $J = 9.3, 8.4$ Hz, 1H), 4.83 (B of ABq, $J_{AB} = 16.4$, 1H), 5.26 (d, $J = 9.4$ Hz, 1H), 5.64 - 5.73 (m, 2H), 6.17 (d, $J = 15.6$ Hz, 1H), 6.71 (m, 2H), 6.86 (s, 2H), 7.05 - 7.30 (m, 6H), 7.34 (m, 2H); ^{13}C NMR (75 MHz, $CDCl_3$) $\delta = -5.1, -4.7, -4.4, 13.1, 13.3, 14.4, 18.1, 18.5, 20.9, 22.9, 25.9, 26.0, 47.5, 48.2, 56.8, 64.0, 70.9, 77.8, 126.4, 126.7, 127.3, 127.7, 127.9, 128.3, 128.4, 128.5, 132.1, 132.2, 133.2, 134.0, 134.5, 138.3, 138.7, 140.4, 142.5, 173.1$; HRMS calculated for $C_{47}H_{71}NO_6SSi_2Na$ $[M+Na]^+$: 856.4438, found: 856.4448.

(2*S*,4*R*,5*R*,6*E*,8*E*)-10-(tert-butyldimethylsilyloxy)-5-hydroxy-4,7-dimethyl-3-oxodeca-6,8-dien-2-yl benzoate 210

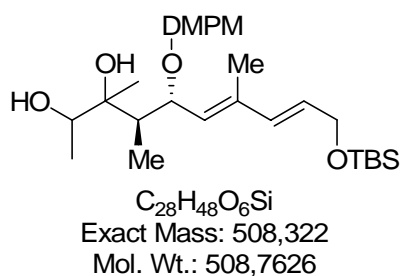
To a stirred solution (-78 °C) of (S)-3-oxopentan-2-yl benzoate (1.88 g, 9.12 mmol, 1.0 eq.) in Et₂O (8 mL) was added chlorodicyclohexylborane (3.05 mL, 13.7 mmol, 1.5 eq.) and Me₂NEt (1.9 mL, 18 mmol, 2 eq.). The mixture was warmed to 0 °C, stirred for 2 h and then re-cooled to -78 °C. A solution of aldehyde (2.63 g, 10.9 mmol, 1.2 eq.) in Et₂O (8 mL) was added dropwise over 2 min. After 3 h, the reaction was kept in the freezer (-22 °C) overnight (14 h). The mixture was warmed to 0 °C and quenched by dropwise addition of MeOH (15 mL), pH7 phosphate buffer (15 mL) and 30% H₂O₂ (15 mL) and stirred for 2 h. Water (60 mL) was added, the organic layer was separated and the aqueous layer was extracted with Et₂O (4 × 50 mL). The combined organics were dried over MgSO₄, filtered and evaporated *in vacuo*. Silica gel chromatography (hexanes / EtOAc, gradient elution, 9:1 to 6:1) afforded ketone (3.95 g, 8.85 mmol, 97%) as a colorless oil.

$R_f = 0.61$ (hexanes / EtOAc = 4:1); $[\alpha]_D^{20} = +30.0$ ($c = 2.16$, CHCl₃); ¹H NMR (300 MHz, CDCl₃) $\delta = 0.07$ (s, 6H), 0.91 (s, 9H), 1.13 (d, $J = 7.2$ Hz, 3H), 1.55 (d, $J = 7.2$ Hz, 3H), 1.81 (s, 3H), 2.17 (d, $J = 4.3$ Hz, 1H), 2.92 (m, 1H), 4.24 (dd, $J = 5.0, 1.4$ Hz, 2H), 4.70 (m, 1H), 5.36 (d, $J = 9.2$ Hz, 1H), 5.44 (q, $J = 7.0$ Hz, 1H), 5.77 (dt, $J = 15.5, 5.1$ Hz, 1H), 6.23 (d, $J = 15.6$ Hz, 1H), 7.45 (tm, $J = 7.5$ Hz, 2H), 7.57 (tm, $J = 7.4$ Hz, 1H), 8.07 (dm, $J = 7.2$ Hz, 2H); ¹³C NMR (75 MHz, CDCl₃) $\delta = -5.2, 13.3, 14.2, 15.6, 18.4, 26.0, 48.8, 63.7, 70.4, 75.0, 128.5, 129.3, 129.8, 130.9, 133.4, 136.7, 165.9, 211.1$; HRMS calculated for C₂₅H₃₈O₅SiNa [M+Na]⁺: 469.2386, found: 469.2390.

(2*S*,4*R*,5*R*,6*E*,8*E*)-10-(tert-butyldimethylsilyloxy)-5-(3,4-dimethoxybenzyloxy)-4,7-dimethyl-3-oxodeca-6,8-dien-2-yl benzoate 210

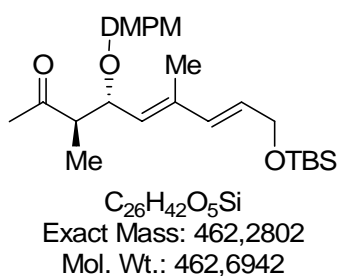
To a solution of the alcohol (180 mg, 0.403 mmol, 1.0 eq.) and PPTS (50.6 mg, 0.201 mmol, 0.5 eq.) in abs. DCM (3 mL) was added a solution of imidate (252 mg, 0.806 mmol, 2.0 eq.) in abs. DCM (2 mL). The reaction mixture was stirred at RT for 23 h. Sat. aq. $NaHCO_3$ (6 mL) were added, the organic phase separated, and the aq. phase extracted with DCM (3 × 10 mL). The combined organic extracts were dried over $MgSO_4$ and concentrated *in vacuo*. Purification by flash chromatography (hexanes / Et_2O = 15:1) gave DMPM-ether (90.4 mg, 0.151 mmol, 37%, two steps) as a white solid.

R_f = 0.41 (hexanes / $EtOAc$ = 6:1); $[\alpha]_D^{20}$ = -1.63 (c = 1.24, $CHCl_3$); 1H NMR (400 MHz, $CDCl_3$) δ = 0.08(s, 6H), 0.92 (s, 9H), 1.01 (d, J = 7.1 Hz, 3H), 1.51 (d, J = 7.1 Hz, 3H), 1.77 (s, 3H), 3.00 (m, 1H), 3.85 (s, 3H), 3.87 (s, 3H), 4.16 (d, J = 11.2 Hz, 1H), 4.26 (d, J = 5.1 Hz, 2H), 4.36 (d, J = 11.2 Hz, 1H), 4.44 (t, J = 9.7 Hz, 1H), 5.28 (d, J = 9.7 Hz, 1H), 5.41 (q, J = 7.1 Hz, 1H), 5.78 (dt, J = 15.8, 5.1 Hz, 1H), 6.31 (d, J = 15.8 Hz, 1H), 6.72 (m, 3H), 7.44 (t, J = 7.6 Hz, 2H), 7.56 (t, J = 7.4 Hz, 1H), 8.05 (d, J = 7.1 Hz, 2H); ^{13}C NMR (100 MHz, $CDCl_3$) δ = -5.2, 13.4, 13.9, 15.3, 18.5, 26.0, 47.6, 55.8, 63.7, 70.3, 75.4, 110.6, 111.1, 120.0, 128.4, 128.9, 129.7, 130.9, 133.2, 133.4, 138.6, 148.3, 148.8, 165.8, 209.7; HRMS calculated for $C_{34}H_{48}O_7SiNa$ $[M+Na]^+$: 619.3067, found: 619.3067.

(4R,5R,6E,8E)-10-(tert-butyldimethylsilyloxy)-5-(3,4-dimethoxybenzyloxy)-3,4,7-trimethyldeca-6,8-diene-2,3-diol 211

To a solution of the ketone (74.8 mg, 0.125 mmol, 1.0 eq.) in Et₂O (2 mL) was added MeLi ((235 μL, 1.6 M in Et₂O, 0.376 mmol, 3.0 eq) at -78 °C. The reaction mixture was warmed up to -20 °C for 4 h and quenched with sat. aq. NH₄Cl (6 mL). After warming to room temperature, the organic layer was separated and the aqueous layer was extracted with EtOAc (3 × 10 mL). The combined organics were dried over MgSO₄, filtered and evaporated *in vacuo*. Silica gel chromatography (hexanes / EtOAc, 2:1) afforded the diol (14.0 mg, 27.5 μmol, 22%) as a colorless oil.

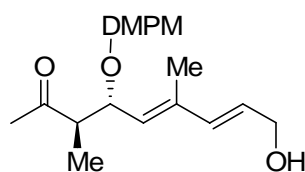
R_f = 0.21 (hexanes / EtOAc = 2:1); ¹H NMR (300 MHz, CDCl₃) δ = 0.09(s, 6H), 0.63 (d, J = 7.0 Hz, 3H), 0.93 (s, 9H), 1.14 (d, J = 6.2 Hz, 3H), 1.21 (s, 3H), 1.61 (s, 1H), 1.80 (s, 3H), 1.93 (m, 1H), 2.32 (s, 1H), 3.47 (m, 1H), 3.86 (s, 3H), 3.87 (s, 3H), 4.21 (d, J = 10.9 Hz, 1H), 4.28 (m, 3H), 4.47 (d, J = 11.1 Hz, 1H), 5.33 (d, J = 9.6 Hz, 1H), 5.80 (dt, J = 15.6, 5.1 Hz, 1H), 6.33 (d, J = 15.6 Hz, 1H), 6.81 (m, 3H); ¹³C NMR (75 MHz, CDCl₃) δ = -5.1, 12.2, 13.6, 16.9, 18.5, 19.1, 26.0, 43.0, 55.9, 63.7, 70.2, 72.3, 76.4, 78.7, 111.0, 111.7, 121.1, 129.1, 129.8, 130.5, 133.4, 137.9, 148.9, 149.0; HRMS calculated for C₂₈H₄₈O₆SiNa [M+Na]⁺: 531.3118, found: 531.3110.

(3R,4R,5E,7E)-9-(tert-butyldimethylsilyloxy)-4-(3,4-dimethoxybenzyloxy)-3,6-dimethylnona-5,7-dien-2-one 212

To a solution of the diol (2.3 mg, 4.5 μmol , 1.0 eq.) in THF (200 μL) was added a solution of NaIO_4 in H_2O (50 μL , 12.0 mg / 500 μL , 5.6 μmol , 1.2 eq.) at room temperature. After 2.5 h, (3.0 mg, 14.0 μmol , 3.1 eq.) was added as solid. After 3.5 h, a solution of NaIO_4 in H_2O (100 μL , 12.0 mg / 500 μL , 11.2 μmol , 2.4 eq.) was added. After 6.5 h, the reaction was quenched with H_2O (4 mL). The organic layer was separated and the aqueous layer was extracted with DCM (3 \times 3 mL). The combined organics were dried over MgSO_4 , filtered and evaporated *in vacuo*. Silica gel chromatography (hexanes / EtOAc, 2:1) afforded the methyl ketone (1.8 mg, 3.9 μmol , 86%) as a colorless oil.

$R_f = 0.72$ (hexanes / EtOAc = 2:1); $[\alpha]_D^{20} = -36.0$ ($c = 0.13$, CHCl_3); $^1\text{H NMR}$ (400 MHz, CDCl_3) $\delta = 0.09$ (s, 6H), 0.90 (d, $J = 7.1$ Hz, 3H), 0.92 (s, 9H), 1.78 (s, 3H), 2.19 (s, 3H), 2.75 (m, 1H), 3.85 (s, 3H), 3.87 (s, 3H), 4.19 (d, $J = 11.2$ Hz, 1H), 4.27 (d, $J = 5.1$ Hz, 2H), 4.32 (t, $J = 9.7$ Hz, 1H), 4.41 (d, $J = 11.7$ Hz, 1H), 5.28 (d, $J = 9.7$ Hz, 1H), 5.79 (dt, $J = 15.8, 5.1$ Hz, 1H), 6.31 (d, $J = 16.3$ Hz, 1H), 6.75 (m, 3H); $^{13}\text{C NMR}$ (100 MHz, CDCl_3) $\delta = -5.1, 13.1, 13.5, 18.5, 26.0, 30.8, 51.5, 55.8, 55.9, 63.8, 70.1, 110.8, 111.2, 120.2, 128.9, 129.8, 130.9, 133.6, 138.4, 148.5, 148.9, 211.9$; HRMS calculated for $\text{C}_{26}\text{H}_{42}\text{O}_5\text{SiNa}$ $[\text{M}+\text{Na}]^+$: 485.2699, found: 485.2695.

(3R,4R,5E,7E)-4-(3,4-dimethoxybenzyloxy)-9-hydroxy-3,6-dimethylnona-5,7-dien-2-one
213



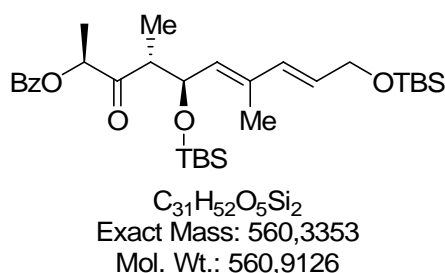
$\text{C}_{20}\text{H}_{28}\text{O}_5$
Exact Mass: 348,1937
Mol. Wt.: 348,4333

To a solution of diol (11.7 mg, 23.0 μmol , 1.0 eq.) in THF / H_2O (200 μL / 50 μL) was added NaIO_4 (29.5 mg, 138 μmol , 6.0 eq.) at room temperature. After stirring for 6.5 h, the reaction was quenched with H_2O (4 mL). The organic layer was separated and the aqueous layer was extracted with DCM (3 \times 6 mL). The combined organics were dried over MgSO_4 , filtered and evaporated *in vacuo*. Silica gel chromatography (hexanes / EtOAc, 2:1) afforded the methyl ketone (7.5 mg, 21.5 μmol , 93%) as a colorless oil.

$R_f = 0.09$ (hexanes / EtOAc = 2:1); $[\alpha]_D^{20} = -20.4$ ($c = 0.37$, CHCl_3); $^1\text{H NMR}$ (400 MHz, CDCl_3) $\delta = 0.90$ (d, $J = 7.1$ Hz, 3H), 1.41 (t, $J = 5.9$ Hz, 1H), 1.79 (d, $J = 1.5$ Hz, 3H), 2.19 (s,

3H), 2.75 (m, 1H), 3.85 (s, 3H), 3.87 (s, 3H), 4.19 (d, $J = 11.2$ Hz, 1H), 4.25 (t, $J = 5.1$ Hz, 2H), 4.33 (t, $J = 9.7$ Hz, 1H), 4.40 (d, $J = 11.7$ Hz, 1H), 5.32 (d, $J = 9.7$ Hz, 1H), 5.87 (dt, $J = 15.8, 5.8$ Hz, 1H), 6.33 (d, $J = 15.8$ Hz, 1H), 6.75 (m, 3H); ^{13}C NMR (100 MHz, CDCl_3) $\delta = 13.1, 13.5, 30.8, 51.4, 55.8, 55.9, 63.6, 70.3, 110.8, 111.2, 120.2, 128.3, 130.7, 135.2, 138.1, 148.5, 148.9, 211.8$; HRMS calculated for $\text{C}_{20}\text{H}_{28}\text{O}_5\text{Na}$ $[\text{M}+\text{Na}]^+$: 371.1834, found: 371.1838.

(2*S*,4*R*,5*R*,6*E*,8*E*)-5,10-bis(tert-butyldimethylsilyloxy)-4,7-dimethyl-3-oxodeca-6,8-dien-2-yl benzoate 214

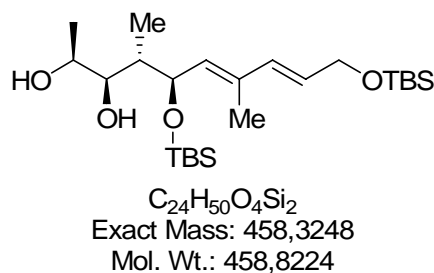


To a stirred solution (-78 °C) of the alcohol (2.70 g, 6.04 mmol, 1.0 eq.) in CH_2Cl_2 (5 mL) was slowly added a solution of proton sponge[®] (1.81 g, 8.46 mmol, 1.4 eq.) in CH_2Cl_2 (15 mL) and TBSOTf (1.52 mL, 6.64 mmol, 1.1 eq.). The mixture was stirred at -78 °C for 20 min. The cooling bath was removed and the reaction quenched with sat. aqueous NaHCO_3 (22 mL). The mixture was warmed to room temperature. Et_2O (80 mL) and sat. aqueous NaHCO_3 (20 mL) were added. The organic layer was separated and the aqueous layer was extracted with Et_2O (3 × 40 mL). The combined organics were washed with sat. aqueous NaHCO_3 (50 mL), dried over MgSO_4 , filtered and evaporated *in vacuo*. Silica gel chromatography (hexanes / Et_2O , gradient elution, 9:1 to 6:1) afforded the desired TBS-ether (2.95 g, 5.26 mmol, 87%) as a white solid.

$R_f = 0.63$ (hexanes / $\text{EtOAc} = 9:1$); $[\alpha]_D^{20} = +5.0$ ($c = 0.52$, CHCl_3); ^1H NMR (300 MHz, CDCl_3) $\delta = -0.06$ (s, 3H), -0.04 (s, 3H), 0.07 (s, 6H), 0.80 (s, 9H), 0.91 (s, 9H), 0.99 (d, $J = 7.1$ Hz, 3H), 1.52 (d, $J = 7.1$ Hz, 3H), 1.78 (d, $J = 1.0$ Hz, 3H), 2.89 (m, 1H), 4.24 (dd, $J = 5.1, 1.5, 2\text{H}$), 4.72 (t, $J = 9.7$ Hz, 1H), 5.26 (d, $J = 9.2$ Hz, 1H), 5.41 (q, $J = 7.0$ Hz, 1H), 5.73 (dt, $J = 15.3, 5.1$ Hz, 1H), 6.21 (d, $J = 15.8$ Hz, 1H), 7.44 (tm, $J = 7.6$ Hz, 2H), 7.56 (tm, $J = 7.4$ Hz, 1H), 8.07 (dm, $J = 7.1$ Hz, 2H); ^{13}C NMR (75 MHz, CDCl_3) $\delta = -5.1, -4.9, -4.4, 13.5, 14.0, 15.1, 18.0, 18.5, 25.8, 26.0, 49.5, 63.9, 71.7, 75.4, 128.4$ (2C), $129.8, 132.8, 133.2,$

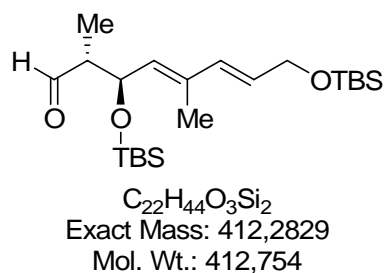
133.9, 134.6, 165.8, 209.4; HRMS calculated for $C_{31}H_{52}O_5Si_2Na$ $[M+Na]^+$: 583.3251, found: 583.3253.

(2*S*,3*R*,4*S*,5*R*,6*E*,8*E*)-5,10-bis(tert-butyldimethylsilyloxy)-4,7-dimethyldeca-6,8-diene-2,3-diol 216



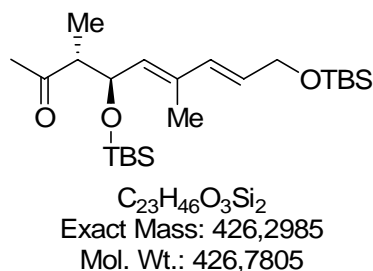
To a cooled (-78 °C) solution of the protected aldol product (1.00 g, 1.78 mmol, 1.0 eq.) in THF (15 mL) was added a solution of $LiBH_4$ (777 mg, 35.6 mmol, 20 eq.) in THF (20 mL). The reaction mixture was warmed slowly to r.t. and stirring was continued for 24 h, before cooling to 0 °C and careful quenching with H_2O (10 mL) and Sat. aq. NH_4Cl (5 mL). The organic layer was separated and the aqueous layer was extracted with Et_2O (4×15 mL) and the combined organic extracts washed with brine (20 mL), dried ($MgSO_4$) and concentrated *in vacuo*. The colorless residue (1.06 g) was used for the next step without further purification.

$R_f = 0.010$ (hexanes / $EtOAc = 9:1$); $[\alpha]_D^{20} = -9.3$ ($c = 0.67$, $CHCl_3$); 1H NMR (400 MHz, $CDCl_3$) $\delta = 0.005$ (s, 3H), 0.06 (s, 3H), 0.07 (s, 6H), 0.74 (d, $J = 7.1$, 3H), 0.88 (s, 9H), 0.91 (s, 9H), 1.15 (d, $J = 6.6$ Hz, 3H), 1.64 (m, 1H), 1.77 (d, $J = 1.5$ Hz, 3H), 2.52 (d, $J = 7.6$ Hz, 1H), 3.59 (m, 1H), 3.78 (m, 1H), 3.81 (d, $J = 2.0$ Hz, 1H), 4.25 (dd, $J = 5.3, 1.3$, 2H), 4.51 (dd, $J = 9.2, 7.6$ Hz, 1H), 5.36 (d, $J = 9.7$ Hz, 1H), 5.74 (dt, $J = 15.8, 5.1$ Hz, 1H), 6.22 (d, $J = 15.8$ Hz, 1H); ^{13}C NMR (100 MHz, $CDCl_3$) $\delta = -5.1, -4.9, -3.9, 12.0, 13.5, 16.3, 18.0, 18.5, 25.8, 26.0, 42.3, 63.9, 68.4, 75.0, 77.6, 128.6, 133.1, 133.8, 133.9$; HRMS calculated for $C_{24}H_{50}O_4Si_2Na$ $[M+Na]^+$: 481.3145, found: 481.3148.

(2R,3R,4E,6E)-3,8-bis(tert-butyldimethylsilyloxy)-2,5-dimethylocta-4,6-dienal 217

To a stirring solution of the crude diol (1.06 g) in toluene (10 mL) under an atmosphere of Ar, at r.t., was added $Pb(OAc)_4$ (868 mg, 1.96 mmol, 1.1 equiv) in three portions over 5 min. After 25 min., direct silica gel chromatography (hexanes / Et_2O , 9:1) afforded aldehyde (662 mg, 1.60 mmol, 90%, two steps) as a colorless oil.

$R_f = 0.62$ (hexanes / $Et_2O = 6:1$); $[\alpha]_D^{20} = -15.2$ ($c = 1.29$, $CHCl_3$); 1H NMR (300 MHz, $CDCl_3$) $\delta = -0.03$ (s, 3H), 0.008 (s, 3H), 0.07 (s, 6H), 0.83 (s, 9H), 0.91 (s, 9H), 0.96 (d, $J = 7.2$ Hz, 3H), 1.78 (s, 3H), 2.47 (m, 1H), 4.25 (dd, $J = 5.3, 1.5$ Hz, 2H), 4.63 (dd, $J = 9.1, 7.6$ Hz, 1H), 5.39 (d, $J = 9.2$ Hz, 1H), 5.75 (dt, $J = 15.6, 5.2$ Hz, 1H), 6.22 (d, $J = 15.6$ Hz, 1H), 9.77 (d, $J = 2.8$ Hz, 1H); ^{13}C NMR (75 MHz, $CDCl_3$) $\delta = -5.1, -4.1, 10.5, 13.3, 18.1, 18.5, 25.7, 26.0, 53.3, 63.9, 71.2, 128.8, 132.4, 133.7, 134.2, 204.7$.

(3R,4R,5E,7E)-4,9-bis(tert-butyldimethylsilyloxy)-3,6-dimethylnona-5,7-dien-2-one 219

To a cold (-78 °C) stirred, solution of the aldehyde (1.21 g, 2.93 mmol, 1.0 eq) was added MeLi (5.50 mL, 1.6 M in Et_2O , 8.79 mmol, 3.0 eq). After stirring for 30 min., the reaction mixture was warmed to -30 °C, and stirred at this temperature for 30 min. The reaction mixture was quenched by addition of pH7 phosphate buffer (15 mL). The organic phase was separated, and the aq. phase thoroughly extracted with Et_2O (3×15 mL). The combined

organics were dried over MgSO_4 , filtered and evaporated *in vacuo*. Silica gel chromatography (hexanes / EtOAc, gradient elution, 9:1 to 2:1) afforded the respective secondary alcohol (1.02 g, 2.39 mmol, 82%) as a colorless oil.

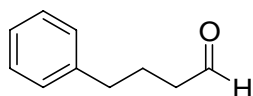
^1H NMR (300 MHz, CDCl_3) δ = -0.01 (s, 3H), 0.05 (s, 3H), 0.07 (s, 6H), 0.87 (s, 9H), 0.91 (s, 9H), 0.93 (d, J = 7.3 Hz, 3H), 1.11 (d, J = 6.4 Hz, 3H), 1.73 (d, J = 1.1 Hz, 3H), 1.51 (m, 1H), 3.54 (d, J = 2.8 Hz, 1H), 4.17 (m, 1H), 4.24 (dd, J = 5.4, 1.4 Hz, 2H), 4.52 (dd, J = 8.7, 4.7 Hz, 1H), 5.56 (d, J = 8.7 Hz, 1H), 5.72 (dt, J = 15.6, 5.3 Hz, 1H), 6.22 (d, J = 15.6 Hz, 1H); ^{13}C NMR (75 MHz, CDCl_3) δ = -5.1, -4.2, 10.9, 13.1, 18.0, 18.5, 25.8, 26.0, 44.2, 64.0, 67.7, 75.1, 128.1, 132.8, 134.0, 134.2.

To a solution of the above prepared alcohol (1.02 g, 2.39 mmol, 1.0 eq.) in CH_2Cl_2 (3 mL) were added NaHCO_3 (462 mg, 5.50 mmol, 2.3 eq) and a solution of *Dess-Martin-Periodinan* (1.22 g, 2.87 mmol, 1.2 eq) in CH_2Cl_2 (13 mL). The resulting solution was stirred 90 min at room temperature. Sat. aq. Na_2SO_3 (15 mL) and sat. aq. NaHCO_3 (15 mL) were added, the organic phase separated, and the aq. phase thoroughly extracted with CH_2Cl_2 (3 x 15 mL). The combined organic phases were dried over MgSO_4 . Evaporation of the solvent *in vacuo* and flash chromatography (hexanes / Et_2O = 9:1) afforded the ketone (932 mg, 2.18 mmol, 92%) as a colorless oil.

R_f = 0.50 (hexanes / Et_2O = 9:1); $[\alpha]_D^{20}$ = -7.1 (c = 0.17, CHCl_3); ^1H NMR (400 MHz, CDCl_3) δ = -0.07 (s, 3H), -0.04 (s, 3H), 0.07 (s, 6H), 0.80 (s, 9H), 0.85 (d, J = 6.6 Hz, 3H), 0.90 (s, 9H), 1.78 (s, 3H), 2.18 (s, 3H), 2.67 (m, 1H), 4.24 (dd, J = 5.3, 1.3 Hz, 2H), 4.55 (t, J = 9.4 Hz, 1H), 5.26 (d, J = 9.2 Hz, 1H), 5.72 (dt, J = 15.3, 5.7 Hz, 1H), 6.21 (d, J = 15.8 Hz, 1H); ^{13}C NMR (100 MHz, CDCl_3) δ = -5.1, -4.2, 13.0, 13.5, 18.0, 18.5, 25.8, 26.0, 31.5, 53.3, 63.9, 72.5, 128.5, 132.9, 133.9, 134.3, 212.4; HRMS calculated for $\text{C}_{23}\text{H}_{46}\text{O}_3\text{Si}_2\text{Na}$ $[\text{M}+\text{Na}]^+$: 449.2883, found: 449.2881.

8.4.2 Connection of the C15-C23 and the C24-C31 Subunits

4-phenylbutanal 221

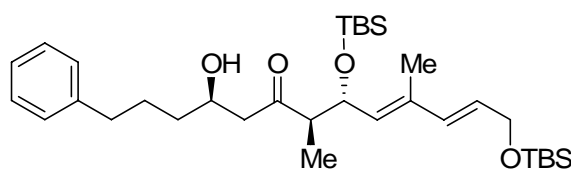


$C_{10}H_{12}O$
Exact Mass: 148,0888
Mol. Wt.: 148,2017

To a solution of the alcohol (148 mg, 0.985 mmol, 1.0 eq.) in CH_2Cl_2 (2 mL) were added *Dess-Martin*-Periodinan (500 mg, 1.18 mmol, 1.2 eq). The resulting solution was stirred 60 min at room temperature. Sat. aq. Na_2SO_3 (5 mL) and sat. aq. $NaHCO_3$ (5 mL) were added, the organic phase separated, and the aq. phase thoroughly extracted with CH_2Cl_2 (3×5 mL). The combined organic phases were dried over $MgSO_4$. Evaporation of the solvent *in vacuo* and flash chromatography (pentane / CH_2Cl_2 = 1:1) afforded the aldehyde (137 mg, 0.924 mmol, 94%) as a colorless oil.

R_f = 0.56 (pentane / CH_2Cl_2 = 1:1); 1H NMR (400 MHz, $CDCl_3$) δ = 1.96 (m, 2H), 2.45 (dt, J = 7.1, 1.5 Hz, 2H), 2.66 (t, J = 7.6 Hz, 2H), 7.19 (m, 3H), 7.29 (m, 2H), 9.75 (t, J = 1.5 Hz, 1H); ^{13}C NMR (100 MHz, $CDCl_3$) δ = 23.7, 35.0, 43.2, 126.1, 141.2, 202.3.

(4*R*,7*R*,8*R*,9*E*,11*E*)-8,13-bis(tert-butyldimethylsilyloxy)-4-hydroxy-7,10-dimethyl-1-phenyltrideca-9,11-dien-6-one 222



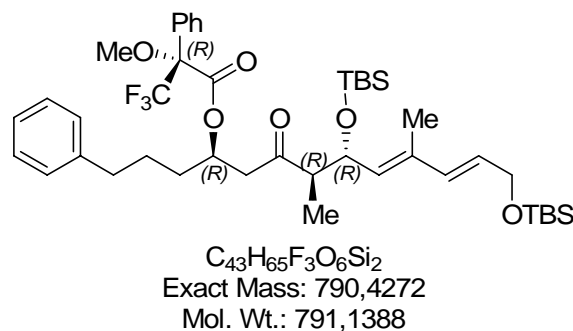
$C_{33}H_{58}O_4Si_2$
Exact Mass: 574,3874
Mol. Wt.: 574,9822

To a solution of (+)-DIPCl (23.4 mg, 73.1 μ mol, 2.6 eq.) in dry Et_2O (50 μ L) was added dry Et_3N (16.0 μ L, 113 mmol, 4.0 eq.) and a solution of ketone (12.0 mg, 28.1 μ mol, 1.0 eq.) in dry Et_2O (200 μ L + 50 μ L washing) at 0 $^\circ C$. The resulting white suspension was stirred at 0 $^\circ C$ for 90 min and then cooled to -78 $^\circ C$. A solution of the aldehyde (12.5 mg, 84.3 μ mol, 3.0 eq.) in dry Et_2O (100 μ L) was added *via* cannula, and the suspension was stirred at -78 $^\circ C$ for

3 h, and then at room temperature for 15 h. The reaction was quenched by the addition of pH7 phosphate buffer (60 μL) and a 30% aqueous solution of H_2O_2 (100 μL) at 0 $^\circ\text{C}$. After warming to room temperature, the layers were separated. The aqueous phase was extracted with CH_2Cl_2 (3×3 mL) and the combined organic extracts were dried (MgSO_4) and concentrated *in vacuo*. The crude oil was flash chromatographed (hexanes / EtOAc, gradient elution, 15:1 to 9:1) to yield an aldol adduct (8.0 mg, 13.9 μmol , 50%) as a yellow oil.

$R_f = 0.34$ (hexanes / EtOAc = 9:1); $[\alpha]_D^{20} = -39.4$ ($c = 0.04$, CHCl_3); $^1\text{H NMR}$ (400 MHz, CDCl_3) $\delta = -0.07$ (s, 3H), -0.05 (s, 3H), 0.07 (s, 6H), 0.79 (s, 9H), 0.84 (d, $J = 7.1$ Hz, 3H), 0.91 (s, 9H), 1.40 (m, 1H), 1.52 (m, 1H), 1.70 (m, 2H), 1.78 (d, $J = 1.0$, 3H), 2.54 (m, 1H), 2.63 (m, 3H), 2.73 (m, 1H), 3.16 (d, $J = 3.0$ Hz, 1H), 4.07 (m, 1H), 4.25 (dd, $J = 5.1, 1.5$ Hz, 2H), 4.56 (t, $J = 9.4$ Hz, 1H), 5.24 (d, $J = 9.7$ Hz, 1H), 5.74 (dt, $J = 15.3, 5.1$ Hz, 1H), 6.21 (d, $J = 15.8$ Hz, 1H), 7.17 (m, 3H), 7.26 (m, 2H); $^{13}\text{C NMR}$ (100 MHz, CDCl_3) $\delta = -5.1, -4.2, 13.0, 13.5, 18.0, 18.5, 25.8, 26.0, 27.2, 35.7, 51.4, 53.0, 63.9, 67.0, 72.6, 125.7, 128.3, 128.4, 128.7, 132.6, 133.8, 134.6, 142.3, 215.9$; HRMS calculated for $\text{C}_{33}\text{H}_{58}\text{IO}_4\text{Si}_2\text{Na}$ $[\text{M}+\text{Na}]^+$: 597.3771, found: 597.3770.

(R)-((4R,7R,8R,9E,11E)-8,13-bis(tert-butyldimethylsilyloxy)-7,10-dimethyl-6-oxo-1-phenyltrideca-9,11-dien-4-yl) 3,3,3-trifluoro-2-methoxy-2-phenylpropanoate 223

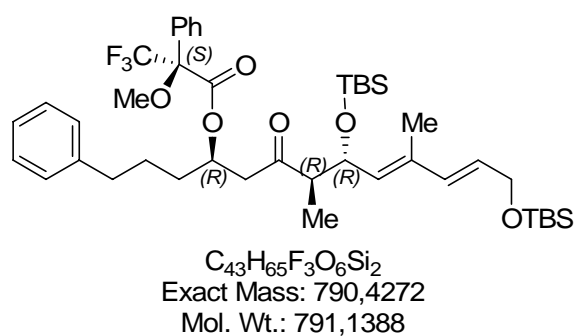


To a stirred solution of (2R)-3,3,3-trifluoro-2-methoxy-2-phenylpropanoic acid (3.7 mg, 15.6 μmol , 3.0 eq.), Et_3N (2.0 μL , 17.2 μmol , 3.3 eq.) and DMAP (2.1 mg, 17.2 μmol , 3.3 eq.) in toluene (50 μL) were added 2,4,6-trichlorobenzoyl chloride (2.4 μL , 15.6 μmol , 3.0 eq.) and a solution of alcohol (3.0 mg, 5.2 μmol , 1.0 eq.) in toluene (100 μL) at room temperature. The resulted white slurry was stirred at room temperature for 20 minutes before being quenched with pH7 phosphate buffer (0.5 mL) and H_2O (1 mL) at 0 $^\circ\text{C}$. DCM (2 mL) was added and the layers were separated. The aqueous layer was extracted with DCM (3×2 mL). The

combined organic extracts were dried (MgSO_4) and concentrated *in vacuo*. Flash column chromatography (hexanes / EtOAc = 9:1) afforded the ester (3.6 mg, 4.6 μmol , 88%) as a colorless oil.

R_f = 0.67 (hexanes / EtOAc = 9:1); ^1H NMR (400 MHz, CDCl_3) δ = -0.08 (s, 3H), -0.07 (s, 3H), 0.07 (s, 6H), 0.77 (s, 9H), 0.78 (d, J = 7.0 Hz, 3H), 0.91 (s, 9H), 1.62 (m, 4H), 1.77 (d, J = 1.0, 3H), 2.58 (m, 3H), 2.71 (dd, J = 18.3, 4.1 Hz, 1H), 2.93 (dd, J = 18.3, 8.6 Hz, 1H), 3.48 (d, J = 1.0 Hz, 3H), 4.24 (dd, J = 5.1, 1.0 Hz, 2H), 4.54 (t, J = 9.4 Hz, 1H), 5.21 (d, J = 9.7 Hz, 1H), 5.58 (m, 1H), 5.73 (dt, J = 15.8, 5.1 Hz, 1H), 6.20 (d, J = 15.3 Hz, 1H), 7.07 (m, 2H), 7.16 (m, 1H), 7.24 (m, 2H), 7.35 (m, 3H), 7.49 (m, 2H).

(S)-((4R,7R,8R,9E,11E)-8,13-bis(tert-butyldimethylsilyloxy)-7,10-dimethyl-6-oxo-1-phenyltrideca-9,11-dien-4-yl) 3,3,3-trifluoro-2-methoxy-2-phenylpropanoate 224

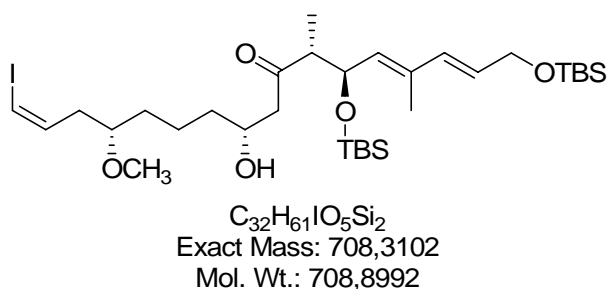


To a stirred solution of (2S)-3,3,3-trifluoro-2-methoxy-2-phenylpropanoic acid (3.7 mg, 15.6 μmol , 3.0 eq.), Et_3N (2.0 μL , 17.2 μmol , 3.3 eq.) and DMAP (2.1 mg, 17.2 μmol , 3.3 eq.) in toluene (50 μL) were added 2,4,6-trichlorobenzoyl chloride (2.4 μL , 15.6 μmol , 3.0 eq.) and a solution of alcohol (3.0 mg, 5.2 μmol , 1.0 eq.) in toluene (100 μL) at room temperature. The resulting white slurry was stirred at room temperature for 20 minutes before being quenched with pH7 phosphate buffer (0.5 mL) and H_2O (1 mL) at 0 $^\circ\text{C}$. DCM (2 mL) was added and the layers were separated. The aqueous layer was extracted with DCM (3 \times 2 mL). The combined organic extracts were dried (MgSO_4) and concentrated *in vacuo*. Flash column chromatography (hexanes / EtOAc = 9:1) afforded the ester (3.6 mg, 4.6 μmol , 98%) as a colorless oil.

R_f = 0.71 (hexanes / EtOAc = 9:1); ^1H NMR (400 MHz, CDCl_3) δ = -0.08 (s, 6H), 0.07 (s, 6H), 0.67 (d, J = 7.0 Hz, 3H), 0.77 (s, 9H), 0.91 (s, 9H), 1.68 (m, 4H), 1.76 (d, J = 1.0, 3H), 2.53 (m, 1H), 2.61 (m, 2H), 2.68 (dd, J = 18.3, 4.1 Hz, 1H), 2.88 (dd, J = 18.1, 7.9 Hz, 1H), 3.49 (d, J = 1.0 Hz, 3H), 4.24 (dd, J = 5.3, 1.3 Hz, 2H), 4.51 (t, J = 9.4 Hz, 1H), 5.20 (d, J =

9.7 Hz, 1H), 5.60 (m, 1H), 5.72 (dt, $J = 15.3, 5.1$ Hz, 1H), 6.19 (d, $J = 15.3$ Hz, 1H), 7.12 (m, 2H), 7.17 (m, 1H), 7.25 (m, 2H), 7.35 (m, 3H), 7.50 (m, 2H).

(2E,4Z,6R,7R,10R,14S,16Z)-1,6-bis(tert-butyldimethylsilyloxy)-10-hydroxy-17-iodo-14-methoxy-4,7-dimethylheptadeca-2,4,16-trien-8-one 225

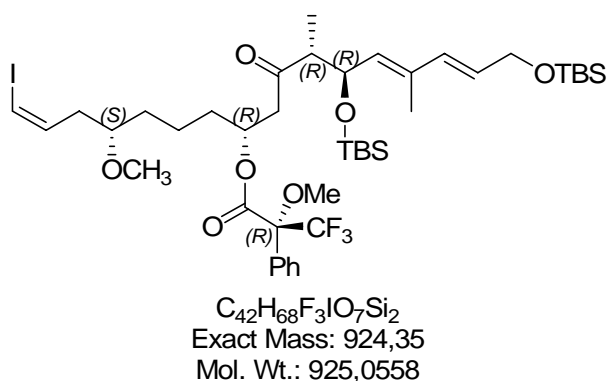


To a solution of ketone (230 mg, 0.540 mmol, 1.0 eq.) in dry Et₂O (0.7 mL) was added dry Et₃N (227 μL, 1.62 mmol, 3.0 eq.) and a solution of (+)-DIPCl (449 mg, 1.40 mmol, 2.6 eq. under high vacuum for 4 h to remove any traces of HCl) in dry Et₂O (2 mL) at 0 °C. The resultant white suspension was stirred at 0 °C for 60 min and then cooled to -78 °C. A solution of the aldehyde (198 mg, 0.702 mmol, 1.3 eq.) in dry Et₂O (1 mL + 2 × 0.5 mL for washings) was added *via* cannula, and the suspension was stirred at -78 °C for 2 h, -60 °C for 1 h and then at -20 °C for 18 h. The reaction was quenched by the addition of pH7 phosphate buffer (6 mL) and after warming to room temperature, the layers were separated. The aqueous phase was extracted with Et₂O (3 × 6 mL) and the combined organic extracts were concentrated *in vacuo*. The resultant residue was taken up in MeOH (6 mL) and pH7 phosphate buffer (3 mL) and cooled to 0 °C. A 30% aqueous solution of H₂O₂ (1 mL) was added and the mixture was warmed to RT and stirred for 2.5 h. CH₂Cl₂ (6 mL) and H₂O (6 mL) were added and the layers were separated. The aqueous phase was extracted with CH₂Cl₂ (4×8 mL). The combined organic extracts were dried (MgSO₄) and concentrated *in vacuo*. The crude oil was flash chromatographed (hexanes / EtOAc, gradient elution, 9:1 to 4:1) to yield an aldol adduct (289 mg, 0.408 mmol, 76%) as a colorless oil.

$R_f = 0.11$ (hexanes / EtOAc = 9:1); $[\alpha]_D^{20} = -34.1$ ($c = 0.73$, CHCl₃); ¹H NMR (600 MHz, CDCl₃) $\delta = -0.06$ (s, 3H), -0.04 (s, 3H), 0.07 (s, 6H), 0.80 (s, 9H), 0.85 (d, $J = 7.0$ Hz, 3H), 0.91 (s, 9H), 1.44 (m, 6H), 1.79 (s, 3H), 2.35 (m, 2H), 2.56 (dd, $J = 18.3, 9.5$ Hz, 1H), 2.65 (m, 3H), 2.75 (dd, $J = 18.3, 2.2$ Hz, 1H), 3.18 (s, 1H), 3.30 (m, 1H), 3.34 (s, 3H), 4.05 (m, 1H), 4.25 (d, $J = 5.3$ Hz, 2H), 4.57 (t, $J = 9.3$ Hz, 1H), 5.24 (d, $J = 9.2$ Hz, 1H), 5.74 (dt, $J =$

15.8, 5.1 Hz, 1H), 6.21 (d, $J = 15.8$ Hz, 1H), 6.24 (q, $J = 6.6$ Hz, 1H), 6.29 (d, $J = 7.3$ Hz, 1H); ^{13}C NMR (100 MHz, CDCl_3) $\delta = -5.1, -4.2, 13.0, 13.5, 18.0, 18.5, 21.4, 25.8, 26.0, 33.6, 36.2, 38.5, 51.4, 53.0, 56.7, 63.9, 67.0, 72.6, 79.5, 84.2, 128.7, 132.6, 133.7, 134.6, 137.6, 215.9$; HRMS calculated for $\text{C}_{32}\text{H}_{61}\text{IO}_5\text{Si}_2\text{Na}$ $[\text{M}+\text{Na}]^+$: 731.3000, found: 731.3000.

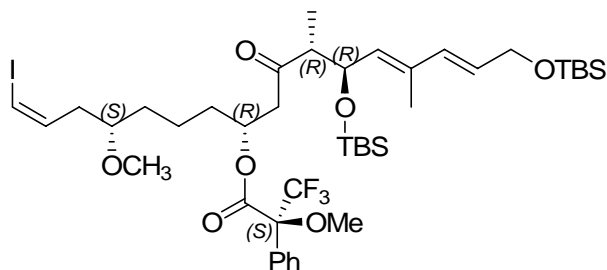
(R)-((1Z,4S,8R,11R,12R,13E,15E)-12,17-bis(tert-butyldimethylsilyloxy)-1-iodo-4-methoxy-11,14-dimethyl-10-oxoheptadeca-1,13,15-trien-8-yl) 3,3,3-trifluoro-2-methoxy-2-phenylpropanoate 225a



To a stirred solution of (2R)-3,3,3-trifluoro-2-methoxy-2-phenylpropanoic acid (3.5 mg, 14.8 μmol , 2.1 eq.), Et_3N (2.0 μL , 16.2 μmol , 2.3 eq.) and DMAP (2.0 mg, 16.4 μmol , 2.3 eq.) in toluene (50 μL) were added 2,4,6-trichlorobenzoyl chloride (2.3 μL , 14.8 μmol , 2.1 eq.) and a solution of alcohol (5.0 mg, 7.0 μmol , 1.0 eq.) in toluene (100 μL) at room temperature. The resulting white slurry was stirred at room temperature for 20 minutes before being quenched with pH7 phosphate buffer (0.5 mL) and H_2O (1 mL) at 0 $^\circ\text{C}$. DCM (2 mL) was added and the layers were separated. The aqueous layer was extracted with DCM (3 \times 2 mL). The combined organic extracts were dried (MgSO_4) and concentrated *in vacuo*. Flash column chromatography (hexanes / EtOAc = 6:1) afforded the ester (5.7 mg, 6.2 μmol , 89%) as a colorless oil.

$R_f = 0.46$ (hexanes / EtOAc = 9:1); ^1H NMR (400 MHz, CDCl_3) $\delta = -0.07$ (s, 3H), -0.05 (s, 3H), 0.07 (s, 6H), 0.79 (d, $J = 6.6$ Hz, 3H), 0.80 (s, 9H), 0.91 (s, 9H), 1.40 (m, 4H), 1.61 (m, 2H), 1.78 (s, 3H), 2.30 (t, $J = 5.6$ Hz, 2H), 2.61 (m, 1H), 2.74 (dd, $J = 18.6, 3.8$ Hz, 1H), 2.95 (dd, $J = 18.3, 8.6$ Hz, 1H), 3.18 (m, 1H), 3.29 (s, 3H), 3.50 (s, 3H), 4.25 (d, $J = 5.1$ Hz, 2H), 4.55 (t, $J = 9.4$ Hz, 1H), 5.23 (d, $J = 9.7$ Hz, 1H), 5.54 (m, 1H), 5.73 (dt, $J = 15.8, 5.1$ Hz, 1H), 6.21 (m, 2H), 6.29 (m, 1H), 7.37 (m, 3H), 7.50 (m, 2H).

(S)-((1Z,4S,8R,11R,12R,13E,15E)-12,17-bis(tert-butyldimethylsilyloxy)-1-iodo-4-methoxy-11,14-dimethyl-10-oxoheptadeca-1,13,15-trien-8-yl) 3,3,3-trifluoro-2-methoxy-2-phenylpropanoate 225b

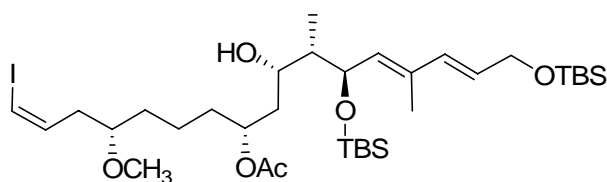


C₄₂H₆₈F₃IO₇Si₂
Exact Mass: 924,35
Mol. Wt.: 925,0558

To a stirred solution of (2S)-3,3,3-trifluoro-2-methoxy-2-phenylpropanoic acid (3.5 mg, 14.8 μ mol, 5.1 eq.), Et₃N (2.0 μ L, 16.2 μ mol, 5.6 eq.) and DMAP (2.0 mg, 16.4 μ mol, 5.6 eq.) in toluene (50 μ L) were added 2,4,6-trichlorobenzoyl chloride (2.3 μ L, 14.8 μ mol, 5.1 eq.) and a solution of alcohol (2.0 mg, 2.9 μ mol, 1.0 eq.) in toluene (100 μ L) at room temperature. The resulting white slurry was stirred at room temperature for 20 minutes before being quenched with pH7 phosphate buffer (0.5 mL) and H₂O (1 mL) at 0 °C. DCM (2 mL) was added and the layers were separated. The aqueous layer was extracted with DCM (3 \times 2 mL). The combined organic extracts were dried (MgSO₄) and concentrated *in vacuo*. Flash column chromatography (hexanes / EtOAc = 6:1) afforded the ester (2.4 mg, 2.6 μ mol, 90%) as a colorless oil.

R_f = 0.50 (hexanes / EtOAc = 9:1); ¹H NMR (300 MHz, CDCl₃) δ = -0.07 (s, 3H), -0.06 (s, 3H), 0.07 (s, 6H), 0.68 (d, *J* = 7.0 Hz, 3H), 0.79 (s, 9H), 0.91 (s, 9H), 1.49 (m, 4H), 1.68 (m, 2H), 1.76 (s, 3H), 2.33 (t, *J* = 5.6 Hz, 2H), 2.55 (m, 1H), 2.68 (dd, *J* = 18.3, 4.1 Hz, 1H), 2.90 (dd, *J* = 18.3, 8.1 Hz, 1H), 3.25 (m, 1H), 3.32 (s, 3H), 3.52 (s, 3H), 4.25 (d, *J* = 5.1 Hz, 2H), 4.52 (t, *J* = 9.4 Hz, 1H), 5.21 (d, *J* = 9.2 Hz, 1H), 5.55 (m, 1H), 5.73 (dt, *J* = 15.6, 5.1 Hz, 1H), 6.22 (m, 2H), 6.30 (m, 1H), 7.37 (m, 3H), 7.52 (m, 2H).

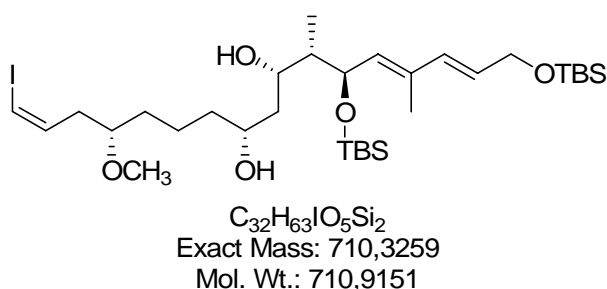
(1Z,4S,8R,10S,11S,12R,13E,15E)-12,17-bis(tert-butyldimethylsilyloxy)-10-hydroxy-1-iodo-4-methoxy-11,14-dimethylheptadeca-1,13,15-trien-8-yl acetate 226



C₃₄H₆₅IO₆Si₂
 Exact Mass: 752,3364
 Mol. Wt.: 752,9518

To a solution of acetaldehyde (320 μ L) in THF (400 μ L) was added SmI₂ (0.1 M in THF, 352 μ L, 35.2 μ mol, 1.25 eq.) at -10 °C. After stirring for 10 min at the same temperature, a solution of the ketone (20.0 mg, 28.2 μ mol, 1.0 eq.) in THF (50 μ L, 2 \times 50 washings) was added at -10 °C. The mixture was stirred 1 h at -10 °C and then placed in a -20 °C freezer for 16 h (without stirring). The reaction was quenched at -20 °C with sat. aq. NaHCO₃ (1 mL) and was stirred for 30 min while warming to room temperature. The mixture was diluted with Et₂O (3 mL) and the layers were separated. The aqueous phases were extracted with Et₂O (3 \times 3 mL). The combined organic phases were dried over MgSO₄, filtered, and concentrated *in vacuo*. Purification by flash chromatography (hexanes / EtOAc, 4:1) afforded alcohol (19.7 mg, 26.2 μ mol, 93%) as colorless oil.

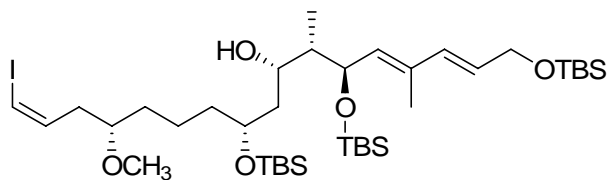
R_f = 0.30 (hexanes / EtOAc = 4:1); [α]_D²⁰ = -11.4 (*c* = 0.19, CHCl₃); ¹H NMR (300 MHz, CDCl₃) δ = -0.03 (s, 3H), 0.01 (s, 3H), 0.07 (s, 6H), 0.75 (d, *J* = 7.0 Hz, 3H), 0.85 (s, 9H), 0.90 (s, 9H), 1.29-1.77 (m, 9H), 1.74 (s, 3H), 2.20 (s, 3H), 2.34 (m, 2H), 3.27 (m, 1H), 3.33 (s, 3H), 3.41 (m, 1H), 3.54 (d, *J* = 3.5 Hz, 1H), 4.24 (dd, *J* = 5.2, 1.0 Hz, 2H), 4.55 (dd, *J* = 9.2, 6.6 Hz, 1H), 5.08 (m, 1H), 5.32 (d, *J* = 9.2 Hz, 1H), 5.70 (dt, *J* = 15.6, 5.4 Hz, 1H), 6.20 (d, *J* = 15.6 Hz, 1H), 6.23 (q, *J* = 7.0 Hz, 1H), 6.29 (d, *J* = 7.3 Hz, 1H); ¹³C NMR (75 MHz, CDCl₃) δ = -5.1, -4.9, -4.0, 10.9, 13.3, 18.1, 18.5, 21.2, 21.4, 25.9, 26.0, 33.4, 35.2, 38.4, 39.0, 45.6, 56.7, 64.0, 68.6, 71.6, 72.2, 79.4, 84.2, 127.8, 133.4, 133.6, 134.4, 137.5, 172.1; HRMS calculated for C₃₄H₆₅IO₆Si₂Na [M+Na]⁺: 775.3262, found: 775.3257.

(1Z,4S,8R,10S,11S,12R,13Z,15E)-12,17-bis(tert-butyldimethylsilyloxy)-1-iodo-4-methoxy-11,14-dimethylheptadeca-1,13,15-triene-8,10-diol 227

To a solution of acetic acid (1.6 mL) in acetonitrile (1.6 mL) was added tetramethylammonium triacetoxyborohydride (274 mg, 1.04 mmol, 4.7 eq.). After stirring for 15 min at room temperature, the mixture was added to a cold (-40 °C) stirred, solution of the β -hydroxy ketone (157 mg, 0.221 mmol, 1.0 eq.) in 5:2 acetonitrile/THF (3.2 mL) *via* cannula. The mixture was then placed in a -20 °C freezer for 40 h (without stirring). The reaction was quenched at -20 °C with a saturated aqueous solution of potassium sodium tartrate tetrahydrate (20 mL) and was stirred for 30 min while warming to room temperature. The mixture was diluted with CH_2Cl_2 (25 mL) and the layers were separated. The aqueous phases were extracted with CH_2Cl_2 (4 \times 15 mL). The combined organic phases were washed with saturated aqueous $NaHCO_3$ (1 \times 20 mL), and dried ($MgSO_4$), filtered, and concentrated to give a yellow oil. Purification by flash chromatography (hexanes / EtOAc, gradient elution, 6:1 to 4:1) afforded the diol (144 mg, 0.203 mmol, 92%) as a clear, colorless oil.

$R_f = 0.33$ (hexanes / EtOAc = 4:1); $[\alpha]_D^{20} = -19.0$ ($c = 0.76$, $CHCl_3$); 1H NMR (600 MHz, $CDCl_3$) $\delta = 0.003$ (s, 3H), 0.06 (s, 3H), 0.07 (s, 6H), 0.67 (d, $J = 7.0$ Hz, 3H), 0.87 (s, 9H), 0.91 (s, 9H), 1.41 (m, 2H), 1.54 (m, 4H), 1.65 (m, 2H), 1.74 (m, 1H), 1.76 (s, 3H), 2.35 (m, 2H), 3.30 (m, 1H), 3.34 (s, 3H), 3.50 (s, 1H), 3.93 (m, 2H), 4.25 (dd, $J = 5.3, 1.2$ Hz, 2H), 4.42 (t, $J = 8.9$ Hz, 1H), 4.76 (s, 1H), 5.34 (d, $J = 9.1$ Hz, 1H), 5.74 (dt, $J = 15.5, 5.3$ Hz, 1H), 6.22 (d, $J = 15.3$ Hz, 1H), 6.26 (m, 2H); ^{13}C NMR (75 MHz, $CDCl_3$) $\delta = -5.1, -3.7, 12.8, 13.6, 18.0, 18.5, 21.7, 25.8, 26.0, 33.8, 37.6, 38.5, 39.4, 44.1, 56.7, 63.9, 68.7, 74.2, 76.5, 79.5, 84.1, 128.8, 133.5, 133.8, 133.9, 137.7$; HRMS calculated for $C_{32}H_{63}IO_5Si_2Na$ $[M+Na]^+$: 733.3157, found: 733.3156.

(5*R*,7*S*,8*S*,9*R*,10*Z*,12*E*)-9-(tert-butyldimethylsilyloxy)-5-((*S*,*Z*)-7-iodo-4-methoxyhept-6-enyl)-2,2,3,3,8,11,16,16,17,17-decamethyl-4,15-dioxo-3,16-disilaoctadeca-10,12-dien-7-ol
229

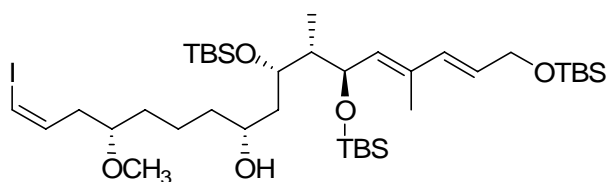


$C_{38}H_{77}IO_5Si_3$
Exact Mass: 824,4123
Mol. Wt.: 825,1759

A flask containing the diole (235 mg, 0.330 mmol, 1.0 eq.), imidazol (112 mg, 1.65 mmol, 5.0 eq.) and TBSCl (124 mg, 0.826 mmol, 2.5 eq.) was charged with argon and abs. DCM (1.1 ml) was added. The reaction mixture was stirred at RT for 30 min. Sat. aq. $NaHCO_3$ (5 mL) were added, the organic phase separated, and the aq. phase thoroughly extracted with DCM (3 × 10 mL). The combined organic extracts were dried over $MgSO_4$ and concentrated *in vacuo*. Purification by flash chromatography (hexanes / Et_2O = 9:1) gave TBS-ether (172 mg, 0.208 mmol, 63%, 77%) as colourless oil.

R_f = 0.60 (hexanes / $EtOAc$ = 9:1); $[\alpha]_D^{20}$ = -14.4 (c = 1.18, $CHCl_3$); 1H NMR (600 MHz, $CDCl_3$) δ = -0.025 (s, 3H), 0.029 (s, 3H), 0.066 (s, 3H), 0.072 (s, 6H), 0.083 (s, 3H), 0.75 (d, J = 7.0 Hz, 3H), 0.86 (s, 9H), 0.88 (s, 9H), 0.91 (s, 9H), 1.32 (m, 1H), 1.41 (m, 2H), 1.49 (m, 4H), 1.63 (m, 2H), 1.77 (d, J = 1.1 Hz, 3H), 2.34 (m, 2H), 3.27 (m, 1H), 3.33 (s, 3H), 3.76 (m, 1H), 3.85 (d, J = 2.2 Hz, 1H), 4.00 (m, 1H), 4.24 (dd, J = 5.5, 1.1 Hz, 2H), 4.52 (dd, J = 9.2, 6.6 Hz, 1H), 5.36 (d, J = 9.2 Hz, 1H), 5.70 (dt, J = 15.4, 5.5 Hz, 1H), 6.21 (d, J = 15.4 Hz, 1H), 6.24 (q, J = 6.8 Hz, 1H), 6.29 (d, J = 7.7 Hz, 1H); ^{13}C NMR (75 MHz, $CDCl_3$) δ = -5.1, -4.8, -4.5, -4.2, -3.9, 11.8, 13.4, 18.1, 18.5, 21.3, 25.9, 26.0, 34.0, 37.5, 38.5, 40.0, 46.0, 56.7, 64.1, 70.2, 70.5, 73.5, 79.5, 84.2, 127.9, 133.3, 133.9, 134.4, 137.6; HRMS calculated for $C_{38}H_{77}IO_5Si_3Na$ $[M+Na]^+$: 847.4021, found: 847.4019.

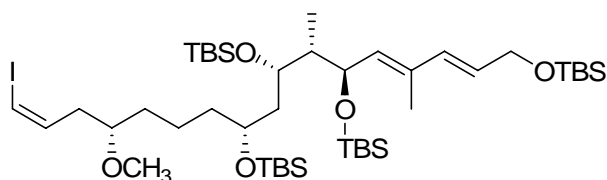
(1*Z*,4*S*,8*R*,10*S*,11*S*,12*R*,13*E*,15*E*)-10,12,17-tris(*tert*-butyldimethylsilyloxy)-1-iodo-4-methoxy-11,14-dimethylheptadeca-1,13,15-trien-8-ol 228



C₃₈H₇₇IO₅Si₃
Exact Mass: 824,4123
Mol. Wt.: 825,1759

$R_f = 0.51$ (hexanes / EtOAc = 9:1); $[\alpha]_D^{20} = -23.3$ ($c = 1.80$, CHCl₃); ¹H NMR (600 MHz, CDCl₃) $\delta = -0.061$ (s, 3H), 0.006 (s, 3H), 0.055 (s, 3H), 0.072 (s, 9H), 0.73 (d, $J = 7.0$, 3H), 0.86 (s, 9H), 0.88 (s, 9H), 0.91 (s, 9H), 1.46 (m, 8H), 1.74 (s, 3H), 1.80 (m, 1H), 2.02 (d, $J = 5.1$ Hz, 1H), 2.34 (m, 2H), 3.30 (m, 1H), 3.34 (s, 3H), 3.79 (m, 1H), 4.21 (t, $J = 8.8$ Hz, 1H), 4.24 (d, $J = 5.1$ Hz, 2H), 4.38 (m, 1H), 5.31 (d, $J = 9.2$ Hz, 1H), 5.70 (dt, $J = 15.5, 5.3$ Hz, 1H), 6.21 (d, $J = 15.4$ Hz, 1H), 6.25 (q, $J = 6.8$ Hz, 1H), 6.29 (d, $J = 7.5$ Hz, 1H); ¹³C NMR (100 MHz, CDCl₃) $\delta = -5.0, -4.8, -4.6, -4.2, -3.8, 9.8, 13.4, 18.1, 18.5, 21.8, 25.9, 26.0, 33.7, 38.1, 38.3, 38.5, 46.1, 56.7, 64.1, 68.9, 69.3, 71.4, 79.6, 84.1, 121.9, 133.0, 133.3, 134.8, 137.6$; HRMS calculated for C₃₈H₇₇IO₅Si₃Na [M+Na]⁺: 847.4021, found: 847.4025.

(6*E*,8*E*,10*R*,11*S*,12*S*,14*R*)-10,12-bis(*tert*-butyldimethylsilyloxy)-14-((*S*,*Z*)-7-iodo-4-methoxyhept-6-enyl)-2,2,3,3,8,11,16,16,17,17-decamethyl-4,15-dioxa-3,16-disilaooctadeca-6,8-diene 230



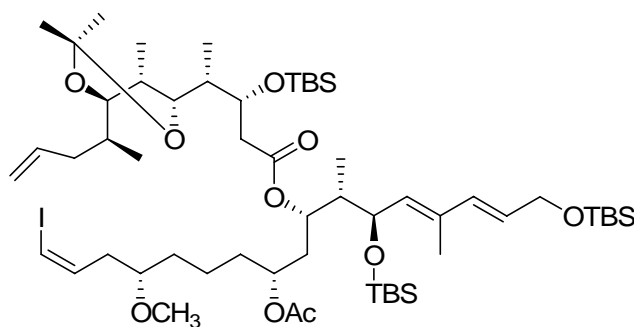
C₄₄H₉₁IO₅Si₄
Exact Mass: 938,4988
Mol. Wt.: 939,4368

$R_f = 0.87$ (hexanes / EtOAc = 9:1); $[\alpha]_D^{20} = -16.3$ ($c = 0.97$, CHCl₃); ¹H NMR (600 MHz, CDCl₃) $\delta = -0.06$ (s, 3H), -0.01 (s, 3H), -0.005 (s, 3H), 0.01 (s, 3H), 0.05 (s, 3H), 0.06 (s, 3H), 0.07 (s, 6H), 0.80 (d, $J = 7.0$ Hz, 3H), 0.85 (s, 9H), 0.86 (s, 9H), 0.89 (s, 9H), 0.91 (s, 9H),

1.42 (m, 7H), 1.73 (d, $J = 0.7$ Hz, 3H), 1.75 (m, 1H), 2.34 (m, 2H), 3.27 (m, 1H), 3.33 (s, 3H), 3.77 (m, 1H), 4.09 (m, 1H), 4.24 (dd, $J = 5.5, 1.1$ Hz, 2H), 4.33 (dd, $J = 8.8, 6.6$ Hz, 1H), 5.41 (d, $J = 8.8$ Hz, 1H), 5.68 (dt, $J = 15.8, 5.5$ Hz, 1H), 6.20 (d, $J = 15.8$ Hz, 1H), 6.25 (m, 1H), 6.28 (m, 1H); ^{13}C NMR (100 MHz, CDCl_3) $\delta = -5.0, -4.8, -4.2, -3.9, -3.7, 10.3, 13.1, 18.1, 18.2, 18.5, 20.9, 26.0, 26.1, 34.0, 38.5, 38.8, 40.4, 46.7, 56.7, 64.2, 70.2, 70.9, 71.7, 79.7, 84.0, 127.5, 132.1, 134.4, 135.2, 137.7$; HRMS calculated for $\text{C}_{44}\text{H}_{91}\text{IO}_5\text{Si}_4\text{Na}$ $[\text{M}+\text{Na}]^+$: 961.4886, found: 961.4870.

8.4.3 Connection of the C15-C31 and the C32-C42 Subunits

(3R,4S)-((2E,4E,6R,7S,8S,10R,14S,16Z)-10-acetoxy-1,6-bis(tert-butyldimethylsilyloxy)-17-iodo-14-methoxy-4,7-dimethylheptadeca-2,4,16-trien-8-yl) 3-(tert-butyldimethylsilyloxy)-4-((4R,5S,6R)-2,2,5-trimethyl-6-((S)-pent-4-en-2-yl)-1,3-dioxan-4-yl)pentanoate 231



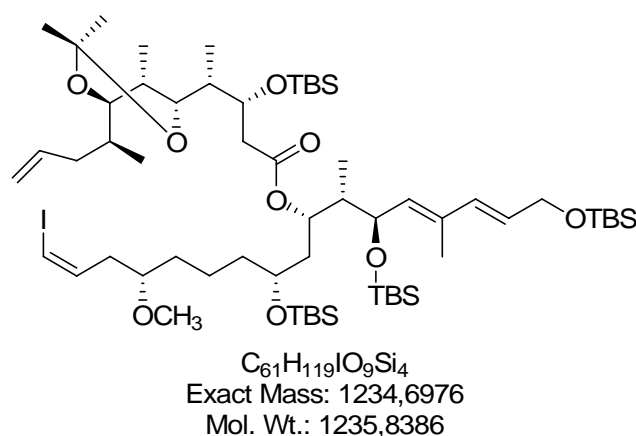
$\text{C}_{57}\text{H}_{107}\text{IO}_{10}\text{Si}_3$
Exact Mass: 1162,6217
Mol. Wt.: 1163,6144

Et_3N (4.4 μL , 31.2 μmol , 2.5 eq.) and 2,4,6-trichlorobenzoyl chloride (5.0 μL , 31.2 μmol , 2.5 eq.) were added to a stirred solution of alcohol (9.4 mg, 12.5 μmol , 1.0 eq.), the acid (6.8 mg, 15.9 μmol , 1.3 eq.), DMAP (7.6 mg, 62.5 μmol , 5.0 eq.) in toluene (300 μL) at 0 $^\circ\text{C}$. The resulted white slurry was stirred at 0 $^\circ\text{C}$ for 30 minutes before being quenched with pH7 phosphate buffer (0.5 mL) and H_2O (0.5 mL). Et_2O (6 mL) was added and the layers were separated. The aqueous layer was extracted with Et_2O (4 \times 3 mL). The combined organic extracts were dried (MgSO_4) and concentrated *in vacuo*. Flash column chromatography (hexanes / $\text{Et}_2\text{O} = 20:1$) afforded the ester (12.7 mg, 10.9 μmol , 87%) as a colorless oil.

$R_f = 0.36$ (hexanes / $\text{Et}_2\text{O} = 9:1$); $[\alpha]_D^{20} = -3.0$ ($c = 0.11$, CHCl_3); ^1H NMR (600 MHz, CDCl_3) $\delta = -0.04$ (s, 3H), -0.03 (s, 3H), 0.02 (s, 3H), 0.07 (s, 9H), 0.74 (d, $J = 7.3$ Hz, 3H), 0.82 (s,

9H), 0.89 (s, 9H), 0.91 (s, 9H), 0.90-0.93 (m, 9H), 1.37 (s, 3H), 1.38 (s, 3H), 1.44 (m, 3H), 1.52 (m, 3H), 1.63 (m, 2H), 1.75 (s, 3H), 1.72-1.78 (m, 3H), 1.83 (m, 1H), 1.94 (s, 3H), 1.97 (m, 1H), 2.11 (m, 1H), 2.16 (m, 1H), 2.34 (m, 3H), 3.27 (m, 1H), 3.40 (s, 3H), 3.38 (m, 2H), 4.23 (m, 2H), 4.25 (d, $J = 5.1$ Hz, 2H), 4.94 (m, 1H), 5.01 (m, 1H), 5.28 (d, $J = 9.2$ Hz, 1H), 5.34 (m, 1H), 5.71 (dt, $J = 15.8, 5.4$ Hz, 1H), 5.75 (m, 1H), 6.20 (d, $J = 15.8$ Hz, 1H), 6.23 (q, $J = 7.0$ Hz, 1H), 6.30 (d, $J = 8.1$ Hz, 1H); ^{13}C NMR (600 MHz, CDCl_3) $\delta = -5.0, -4.8, -4.7, -4.4, -3.6, 5.5, 10.1, 10.4, 13.4, 16.2, 18.0, 18.1, 18.5, 19.7, 21.1, 21.2, 25.9, 26.0, 26.1, 30.1, 30.9, 32.4, 33.8, 33.9, 35.4, 35.8, 37.4, 38.5, 40.3, 42.9, 56.8, 64.1, 68.2, 69.6, 69.9, 71.3, 76.2, 77.9, 79.4, 84.3, 99.0, 116.4, 128.2, 133.5, 134.1, 134.3, 136.7, 137.5, 170.7, 171.4$; HRMS calculated for $\text{C}_{57}\text{H}_{107}\text{IO}_{10}\text{Si}_3\text{Na}$ [$\text{M}+\text{Na}$] $^+$: 1185.6115, found: 1185.6115.

(3R,4S)-((5R,7S,8S,9R,10E,12E)-9-(tert-butyldimethylsilyloxy)-5-((S,Z)-7-iodo-4-methoxyhept-6-enyl)-2,2,3,3,8,11,16,16,17,17-decamethyl-4,15-dioxa-3,16-disilaooctadeca-10,12-dien-7-yl) 3-(tert-butyldimethylsilyloxy)-4-((4R,5S,6R)-2,2,5-trimethyl-6-((S)-pent-4-en-2-yl)-1,3-dioxan-4-yl)pentanoate 232

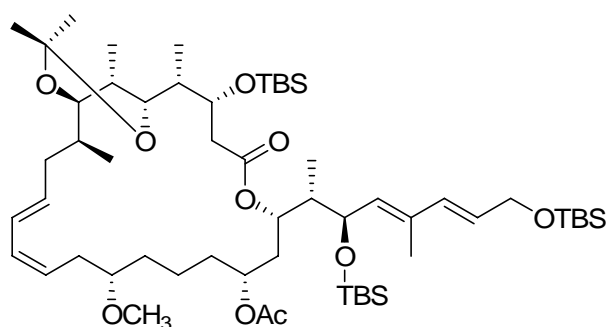


Et_3N (67.0 μL , 0.482 mmol, 2.5 eq.) and 2,4,6-trichlorobenzoyl chloride (76.0 μL , 0.482 mmol, 2.5 eq.) were added to a stirred solution of alcohol (159 mg, 0.193 mmol, 1.0 eq.), the acid (140 mg, 0.326 mmol, 1.7 eq.), DMAP (118 mg, 0.965 mmol, 5.0 eq.) in toluene (7.0 mL) at 0 $^\circ\text{C}$. The resulted white slurry was stirred at room temperature for 30 minutes before being quenched with pH7 phosphate buffer (7.0 mL) and H_2O (7.0 mL) at 0 $^\circ\text{C}$. Et_2O (20 mL) was added and the layers were separated. The aqueous layer was extracted with Et_2O (4 \times 15 mL). The combined organic extracts were dried (MgSO_4) and concentrated *in vacuo*. Flash column chromatography (hexanes / $\text{Et}_2\text{O} = 9:1$) afforded the ester (232 mg, 0.188 mmol, 97%) as a colorless oil.

$R_f = 0.71$ (hexanes / Et₂O = 9:1); $[\alpha]_D^{20} = -1.9$ ($c = 0.56$, CHCl₃); ¹H NMR (600 MHz, CDCl₃) $\delta = -0.05$ (s, 3H), -0.02 (s, 3H), -0.006 (s, 3H), -0.001 (s, 3H), 0.01 (s, 3H), 0.07 (s, 9H), 0.82 (d, $J = 6.0$ Hz, 3H), 0.83 (s, 9H), 0.87 (s, 9H), 0.89 (s, 9H), 0.91 (s, 9H), 0.89 (d, $J = 5.9$ Hz, 3H), 0.90 (d, $J = 6.6$ Hz, 3H), 0.92 (d, $J = 6.6$ Hz, 3H), 1.34 (s, 3H), 1.37 (s, 3H), 1.37 - 1.50 (m, 6H), 1.73 (s, 3H), 1.80 - 1.86 (m, 2H), 2.05 (dd, $J = 16.1, 1.5$ Hz, 1H), 2.10 (m, 1H), 2.15 (dd, $J = 10.6, 5.9$ Hz, 3H), 2.30 - 2.40 (m, 3H), 3.27 (m, 1H), 3.30 (dd, $J = 9.2, 1.5$ Hz, 1H), 3.34 (s, 3H), 3.32 - 3.37 (m, 1H), 3.72 (m, 1H), 4.24 (d, $J = 5.2$ Hz, 2H), 4.23 - 4.27 (m, 1H), 4.34 (dd, $J = 8.8, 5.9$ Hz, 1H), 4.99 (m, 2H), 5.21 (m, 1H), 5.40 (d, $J = 9.2$ Hz, 1H), 5.68 (dt, $J = 15.4, 5.5$ Hz, 1H), 5.72 (m, 1H), 6.19 (d, $J = 15.8$ Hz, 1H), 6.25 (q, $J = 6.9$ Hz, 1H), 6.30 (d, $J = 7.3$ Hz, 1H); ¹³C NMR (100 MHz, CDCl₃) $\delta = -5.0, -4.8, -4.7, -4.5, -4.4, -4.2, -4.0, 5.5, 10.4, 10.7, 13.2, 14.1, 16.2, 17.9, 18.1, 18.5, 19.5, 20.3, 22.7, 25.8, 26.0, 26.1, 30.1, 31.2, 31.6, 33.8, 34.2, 35.9, 36.2, 37.6, 38.2, 38.5, 40.3, 42.7, 56.8, 64.2, 68.1, 68.8, 71.7, 72.6, 76.1, 77.9, 79.6, 84.2, 99.0, 116.4, 127.6, 132.8, 134.0, 134.5, 136.3, 137.5, 171.1$; HRMS calculated for C₆₁H₁₁₉IO₉Si₄Na [M+Na]⁺: 1257.6874, found: 1257.6882.

8.4.4 Completion of the Macrolide Moiety

(1R,2S,3R,7S,9R,13S,15Z,17E,20S,21R,25S)-7-((2S,3R,4E,6E)-3,8-bis(tert-butyldimethylsilyloxy)-5-methylocta-4,6-dien-2-yl)-3-(tert-butyldimethylsilyloxy)-13-methoxy-2,20,23,23,25-pentamethyl-5-oxo-6,22,24-trioxabicyclo[19.3.1]pentacos-15,17-dien-9-yl acetate
233



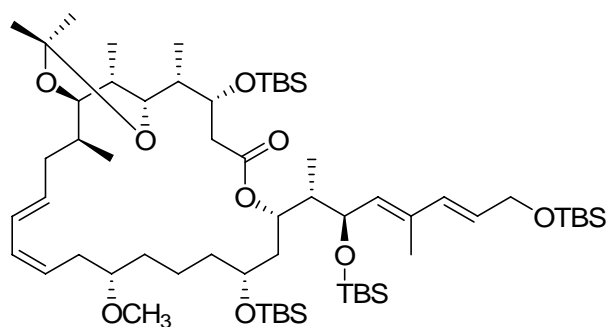
C₅₇H₁₀₆O₁₀Si₃
Exact Mass: 1034,7094
Mol. Wt.: 1035,702

To a solution of iodide (11.6 mg, 9.97 μ mol, 1.0 eq.) in DMF (3.3 mL) was added Pd(OAc)₂ (2.71 mg, 12.0 μ mol, 1.2 eq.), Bu₄NCl (3.30 mg, 12.0 μ mol, 1.2 eq.) and K₂CO₃ (3.42 mg, 24.9 μ mol, 2.5 eq.) at room temperature. The resulting yellow suspension was stirred at 60 °C

for 1 h. After removal of the solvent, the residue was purified by column chromatography (hexanes / Et₂O = 20:1) to give dien (3.50 mg, 3.38 μmol, 34%) as a colorless oil.

$R_f = 0.61$ (hexanes / EtOAc = 9:1); $[\alpha]_D^{20} = +11.6$ ($c = 0.30$, CHCl₃); ¹H NMR (600 MHz, CDCl₃) $\delta = -0.04$ (s, 3H), 0.02 (s, 3H), 0.03 (s, 3H), 0.07 (s, 6H), 0.09 (s, 3H), 0.77 (d, $J = 7.0$ Hz, 3H), 0.84 (s, 9H), 0.88 (s, 9H), 0.90 (d, $J = 6.6$ Hz, 3H), 0.91 (s, 9H), 0.93 (d, $J = 6.6$ Hz, 3H), 0.94 (d, $J = 6.6$ Hz, 3H), 1.30 (m, 2H), 1.34 (s, 3H), 1.37 (s, 3H), 1.40-1.46 (m, 3H), 1.56 (m, 1H), 1.74 (s, 3H), 1.72-1.83 (m, 6H), 1.88 (m, 1H), 1.98 (s, 3H), 2.10 (m, 1H), 2.22 (m, 1H), 2.32 (m, 2H), 2.50 (m, 1H), 3.20 (m, 1H), 3.32 (s, 3H), 3.35 (dd, $J = 9.2, 1.5$ Hz, 1H), 3.42 (m, 1H), 4.18 (m, 1H), 4.24 (dd, $J = 5.1, 0.9$ Hz, 2H), 4.27 (t, $J = 8.4$ Hz, 1H), 4.88 (m, 1H), 5.30 (d, $J = 9.2$ Hz, 1H), 5.37 (m, 2H), 5.66 (m, 1H), 5.70 (dt, $J = 15.8, 5.4$ Hz, 1H), 6.06 (t, $J = 10.8$ Hz, 1H), 6.20 (d, $J = 15.8$ Hz, 1H), 6.28 (dd, $J = 14.7, 11.0$ Hz, 1H); ¹³C NMR (600 MHz, CDCl₃) $\delta = -5.1, -4.8, -4.6, -4.5, -3.8, 5.6, 10.5, 13.4, 16.0, 18.1, 18.5, 19.5, 20.6, 21.4, 25.9, 26.0, 29.7, 30.1, 30.4, 30.8, 31.8, 33.6, 35.2, 35.5, 40.3, 43.4, 56.6, 64.1, 69.4, 70.0, 71.0, 76.1, 77.9, 80.9, 99.0, 125.8, 127.3, 128.1, 130.3, 132.2, 133.4, 134.2, 170.4, 171.9$; HRMS calculated for C₅₇H₁₀₆O₁₀Si₃Na [M+Na]⁺: 1057.6992, found: 1057.6980.

(1R,2S,3R,7S,9R,13S,15Z,17E,20S,21R,25S)-7-((2S,3R,4E,6E)-3,8-bis(tert-butyl dimethyl silyloxy)-5-methylocta-4,6-dien-2-yl)-3,9-bis(tert-butyl dimethyl silyloxy)-13-methoxy-2,20,23,23,25-pentamethyl-6,22,24-trioxabicyclo[19.3.1]pentacos-15,17-dien-5-one 234



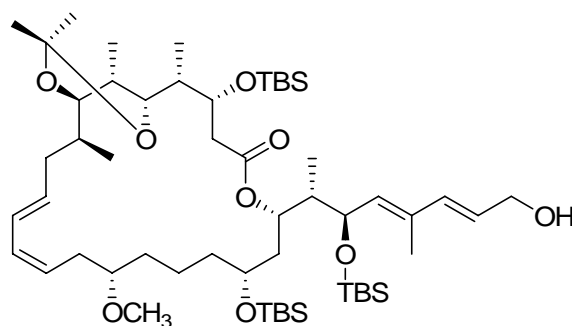
C₆₁H₁₁₈O₉Si₄
Exact Mass: 1106,7853
Mol. Wt.: 1107,9262

To iodide (88.0 mg, 71.2 μmol, 1.0 eq.), Pd(OAc)₂ (16.0 mg, 71.2 μmol, 1.0 eq.), Bu₄NCl (49.5 mg, 178 μmol, 2.5 eq.) and K₂CO₃ (78.5 mg, 569 μmol, 8.0 eq.) was added DMF (18.0 mL) at room temperature. The resulting yellow suspension was stirred at 70 °C for 50 min. The mixture was cooled to room temperature, diluted with Et₂O (40 mL) and filtered through

a celite plug (3 × 10 mL Et₂O). After removal of the solvent, the residue was purified by column chromatography (hexanes / Et₂O = 20:1) to give dien (55.1 mg, 49.7 μmol, 70%) as a colorless oil.

$R_f = 0.55$ (hexanes / Et₂O = 9:1); $[\alpha]_D^{20} = +6.3$ ($c = 0.57$, CHCl₃); ¹H NMR (600 MHz, CDCl₃) $\delta = -0.04$ (s, 3H), 0.005 (s, 3H), 0.02 (s, 3H), 0.04 (s, 3H), 0.07 (s, 9H), 0.08 (s, 3H), 0.83 (d, $J = 7.1$ Hz, 3H), 0.84 (s, 9H), 0.87 (s, 9H), 0.89 (s, 9H), 0.90 (d, $J = 6.6$ Hz, 3H), 0.91 (s, 9H), 0.91 (d, $J = 7.0$ Hz, 3H), 0.93 (d, $J = 6.6$ Hz, 3H), 1.34 (s, 3H), 1.37 (s, 3H), 1.39-1.53 (m, 6H), 1.61 (m, 1H), 1.68-1.75 (m, 2H), 1.73 (s, 3H), 1.80-1.85 (m, 2H), 1.89-1.93 (m, 2H), 2.11 (m, 1H), 2.20 (m, 2H), 2.34 (dd, $J = 16.1, 8.8$ Hz, 1H), 2.46 (m, 1H), 3.20 (m, 1H), 3.31 (s, 3H), 3.31-3.36 (m, 2H), 3.78 (m, 1H), 4.24-4.26 (m, 3H), 4.40 (dd, $J = 9.2, 6.6$ Hz, 1H), 5.17 (m, 1H), 5.36 (d, $J = 9.5$ Hz, 1H), 5.38 (m, 1H), 5.64 (m, 1H), 5.69 (dt, $J = 15.8, 5.3$ Hz, 1H), 6.04 (t, $J = 10.8$ Hz, 1H), 6.20 (d, $J = 15.8$ Hz, 1H), 6.23 (dd, $J = 14.7, 11.0$ Hz, 1H); ¹³C NMR (100 MHz, CDCl₃) $\delta = -5.1, -4.7, -4.5, -4.4, -4.3, -4.1, -3.8, 5.8, 11.3, 13.3, 16.3, 18.0, 18.1, 18.5, 19.6, 25.9, 26.0, 26.1, 30.1, 31.1, 31.8, 35.0, 37.2, 38.3, 40.1, 44.1, 56.5, 64.1, 70.7, 71.0, 72.9, 80.3, 99.1, 126.0, 127.1, 127.9, 130.2, 132.2, 133.1, 133.6, 134.4, 171.0$; HRMS calculated for C₆₁H₁₁₈O₉Si₄Na [M+Na]⁺: 1129.7751, found: 1129.7743.

(1R,2S,3R,7S,9R,13S,15Z,17E,20S,21R,25S)-3,9-bis(tert-butyldimethylsilyloxy)-7-((2S,3R,4E,6E)-3-(tert-butyldimethylsilyloxy)-8-hydroxy-5-methylocta-4,6-dien-2-yl)-13-methoxy-2,20,23,23,25-pentamethyl-6,22,24-trioxabicyclo[19.3.1]pentacosa-15,17-dien-5-one 235



C₅₅H₁₀₄O₉Si₃
Exact Mass: 992,6988
Mol. Wt.: 993,6654

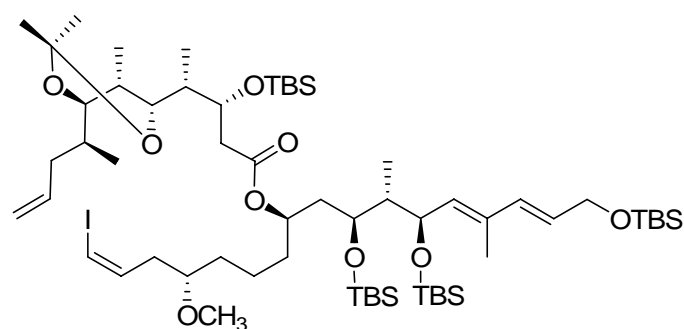
To a solution of the TBS-ether (26.0 mg, 23.5 μmol, 1.0 eq.) was added NH₄F (26.1 mg, 704 μmol, 30 eq.). The yellow reaction mixture was stirred at room temperature for 18 h. After

removing of the solvent, the residue was purified by column chromatography (hexanes / EtOAc = 4:1) to give the alcohol (16.3 mg, 16.4 μ mol, 70%) as colorless oil.

R_f = 0.20 (hexanes / EtOAc = 9:1); $[\alpha]_D^{20}$ = +9.3 (c = 0.10, CHCl_3); ^1H NMR (600 MHz, CDCl_3) δ = -0.04 (s, 3H), 0.01 (s, 3H), 0.02 (s, 3H), 0.04 (s, 3H), 0.06 (s, 3H), 0.07 (s, 3H), 0.84 (s, 9H), 0.87 (s, 9H), 0.89 (d, J = 6.6 Hz, 3H), 0.90 (s, 9H), 0.91 (d, J = 6.6 Hz, 3H), 0.93 (d, J = 6.6 Hz, 3H), 1.34 (s, 3H), 1.37 (s, 3H), 1.34-1.43 (m, 7H), 1.48-1.52 (m, 3H), 1.59 (m, 1H), 1.69 (m, 1H), 1.73-1.84 (m, 3H), 1.75 (s, 3H), 1.89-1.94 (m, 2H), 2.13 (m, 1H), 2.19 (m, 2H), 2.34 (dd, J = 15.8, 8.8 Hz, 1H), 2.47 (m, 1H), 3.21 (m, 1H), 3.31 (s, 3H), 3.31-3.36 (m, 2H), 3.77 (m, 1H), 4.21 (m, 3H), 4.42 (dd, J = 9.2, 6.2 Hz, 1H), 5.16 (m, 1H), 5.37 (m, 1H), 5.43 (d, J = 9.2 Hz, 1H), 5.64 (m, 1H), 5.78 (dt, J = 15.8, 6.0 Hz, 1H), 6.04 (t, J = 10.8 Hz, 1H), 6.23 (m, 2H); ^{13}C NMR (100 MHz, CDCl_3) δ = -4.7, -4.5, -4.4, -4.3, -4.1, -3.9, 5.7, 11.2, 13.3, 16.3, 18.0, 18.1, 19.6, 25.9, 26.1, 30.1, 31.1, 31.4, 35.0, 37.4, 38.2, 40.2, 44.1, 56.4, 64.0, 70.4, 70.9, 72.9, 80.3, 99.1, 126.0, 127.1, 127.4, 130.3, 132.4, 132.8, 134.3, 135.9, 171.1; HRMS calculated for $\text{C}_{55}\text{H}_{104}\text{O}_9\text{Si}_3\text{Na}$ $[\text{M}+\text{Na}]^+$: 1015.6886, found: 1015.6887.

8.4.5 Synthesis of Analogues of Etnangien Macrolide Structure

(3*R*,4*S*)-((1*Z*,4*S*,8*R*,10*S*,11*S*,12*R*,13*E*,15*E*)-10,12,17-tris(tert-butyldimethylsilyloxy)-1-iodo-4-methoxy-11,14-dimethylheptadeca-1,13,15-trien-8-yl) 3-(tert-butyldimethylsilyloxy) -4-((4*R*,5*S*,6*R*)-2,2,5-trimethyl-6-((*S*)-pent-4-en-2-yl)-1,3-dioxan-4-yl)pentanoate 236



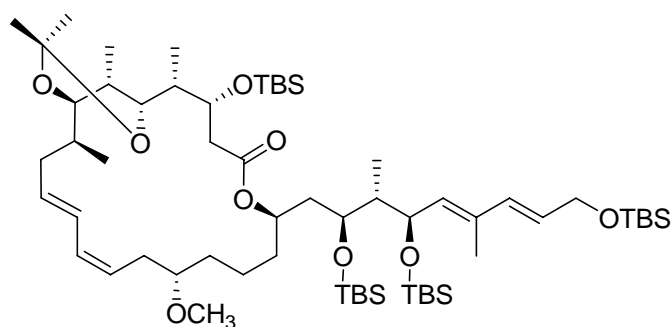
$\text{C}_{61}\text{H}_{119}\text{I}\text{O}_9\text{Si}_4$
Exact Mass: 1234,6976
Mol. Wt.: 1235,8386

Et_3N (7.6 μ L, 54 μ mol, 2.5 eq.) and 2,4,6-trichlorobenzoyl chloride (8.6 μ L, 54 μ mol, 2.5 eq.) were added to a stirred solution of alcohol (18.0 mg, 21.8 μ mol, 1.0 eq.), the acid (15.9 mg, 37.1 μ mol, 1.7 eq.), DMAP (13.3 mg, 109 μ mol, 5.0 eq.) in toluene (0.8 mL) at 0 $^\circ\text{C}$. The resulting white slurry was stirred at room temperature for 30 minutes before being quenched

with pH7 phosphate buffer (1.0 mL) and H₂O (1.0 mL) at 0 °C. DCM (2 mL) was added and the layers were separated. The aqueous layer was extracted with DCM (3 × 5 mL). The combined organic extracts were dried (MgSO₄) and concentrated *in vacuo*. Flash column chromatography (hexanes / Et₂O = 20:1) afforded the ester (24.7 mg, 20.0 μmol, 92%) as a colorless oil.

$R_f = 0.62$ (hexanes / Et₂O = 9:1); $[\alpha]_D^{20} = -7.1$ ($c = 0.50$, CHCl₃); ¹H NMR (600 MHz, CDCl₃) $\delta = -0.06$ (s, 3H), -0.04 (s, 3H), 0.01 (s, 3H), 0.04 (s, 6H), 0.08 (s, 6H), 0.09 (s, 3H), 0.67 (d, $J = 7.3$ Hz, 3H), 0.85 (s, 9H), 0.86 (s, 9H), 0.89 (s, 9H), 0.91 (s, 9H), 0.91 (d, $J = 7.0$ Hz, 3H), 0.92 (d, $J = 7.0$ Hz, 3H), 0.92 (d, $J = 7.0$ Hz, 3H), 1.35 (s, 3H), 1.38 (s, 3H), 1.40 - 1.45 (m, 3H), 1.49 - 1.69 (m, 8H), 1.75 (s, 3H), 1.77 (m, 1H), 1.85 (m, 1H), 2.06 (dd, $J = 16.3, 1.3$ Hz, 1H), 2.15 (m, 1H), 2.30 - 2.39 (m, 3H), 3.29 (m, 2H), 3.33 (m, 1H), 3.34 (s, 3H), 4.15 (t, $J = 9.2$ Hz, 1H), 4.20 (m, 1H), 4.25 (dd, $J = 5.3, 1.3$ Hz, 2H), 4.27 (m, 1H), 4.86 (m, 1H), 4.99 (m, 2H), 5.27 (d, $J = 9.2$ Hz, 1H), 5.71 (m, 1H), 5.71 (dt, $J = 15.4, 5.5$ Hz, 1H), 6.21 (d, $J = 15.4$ Hz, 1H), 6.23 (m, 1H), 6.29 (m, 1H); ¹³C NMR (100 MHz, CDCl₃) $\delta = -5.0, -4.8, -4.7, -4.5, -4.4, -4.0, -3.6, 5.5, 9.2, 10.2, 13.5, 16.2, 18.0, 18.1, 18.5, 19.4, 20.7, 25.9, 26.0, 26.1, 30.1, 31.1, 33.6, 33.8, 34.3, 34.8, 35.9, 37.7, 38.4, 46.4, 56.7, 64.1, 67.6, 67.7, 71.2, 72.2, 76.2, 78.0, 79.4, 84.2, 99.0, 116.4, 128.0, 133.0, 134.3, 134.9, 136.4, 137.5, 171.7$; HRMS calculated for C₆₁H₁₁₉IO₉Si₄Na [M+Na]⁺: 1257.6874, found: 1257.6892.

(1R,2S,3R,7R,11S,13Z,15E,18S,19R,23S)-3-(tert-butyldimethylsilyloxy)-11-methoxy-2,18,21,21,23-pentamethyl-7-((2S,3S,4R,5E,7E)-2,4,9-tris(tert-butyldimethylsilyloxy)-3,6-dimethylnona-5,7-dienyl)-6,20,22-trioxabicyclo[17.3.1]tricoso-13,15-dien-5-one 237



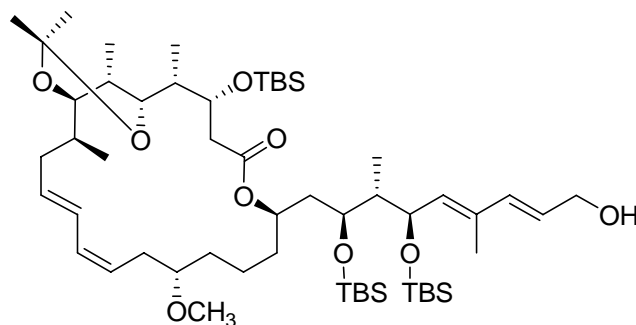
C₆₁H₁₁₈O₉Si₄
Exact Mass: 1106,7853
Mol. Wt.: 1107,9262

To iodide (53.0 mg, 42.9 μmol, 1.0 eq.), Pd(OAc)₂ (9.63 mg, 42.9 μmol, 1.0 eq.), Bu₄NCl (29.8 mg, 107 μmol, 2.5 eq.) and K₂CO₃ (47.3 mg, 343 μmol, 8.0 eq.) was added DMF (11.0

mL) at room temperature. The resulted yellow suspension was stirred at 70 °C for 60 min. The mixture was cooled to room temperature, diluted with Et₂O (24 mL) and filtered through a celite plug (3 × 10 mL Et₂O). After removing of the solvent, the residue was purified by HPLC (Nucleosil-100-7, VP 250 × 21, hexane / EtOAc = 60:1) to give dien (15.3 mg, 13.8 μmol, 32%) as a colorless oil.

$R_f = 0.50$ (hexanes / Et₂O = 9:1); $[\alpha]_D^{20} = +12.9$ ($c = 1.30$, CHCl₃); ¹H NMR (600 MHz, CDCl₃) $\delta = -0.05$ (s, 3H), -0.02 (s, 6H), 0.03 (s, 6H), 0.05 (s, 3H), 0.08 (s, 6H), 0.69 (d, $J = 6.8$ Hz, 3H), 0.85 (s, 9H), 0.87 (d, $J = 7.1$ Hz, 3H), 0.88 (s, 18H), 0.90 (d, $J = 7.1$ Hz, 3H), 0.91 (s, 9H), 0.99 (d, $J = 6.8$ Hz, 3H), 1.35 (s, 3H), 1.37 (s, 3H), 1.45 - 1.57 (m, 6H), 1.63 (m, 1H), 1.74 - 1.83 (m, 5H), 1.75 (s, 3H), 2.09 (m, 1H), 2.18 (m, 3H), 2.33 (m, 1H), 2.50 (m, 1H), 3.31 - 3.46 (m, 3H), 3.35 (s, 3H), 4.17 (t, $J = 9.0$ Hz, 1H), 4.20 (m, 1H), 4.24 (m, 1H), 4.25 (d, $J = 5.6$ Hz, 2H), 4.80 (m, 1H), 5.29 (d, $J = 9.0$ Hz, 1H), 5.46 (m, 1H), 5.66 (m, 1H), 5.70 (dt, $J = 15.8, 5.4$ Hz, 1H), 6.00 (t, $J = 10.9$ Hz, 1H), 6.21 (d, $J = 15.8$ Hz, 1H), 6.43 (dd, $J = 14.3, 11.7$ Hz, 1H); ¹³C NMR (75 MHz, CDCl₃) $\delta = -5.1, -4.9, -4.8, -4.4, -4.3, -4.0, -3.7, 6.0, 9.2, 13.4, 18.0, 18.1, 18.5, 18.8, 19.6, 21.0, 25.9, 26.0, 30.1, 30.4, 30.9, 32.0, 32.3, 33.4, 33.8, 35.0, 40.6, 46.3, 57.1, 64.1, 67.7, 69.0, 71.3, 72.2, 78.8, 80.0, 99.0, 126.0, 126.4, 127.9, 129.9, 132.6, 132.9, 134.3, 135.0, 172.5$; HRMS calculated for C₆₁H₁₁₈O₉Si₄Na [M+Na]⁺: 1129.7751, found: 1129.7721.

(1R,2S,3R,7R,11S,13Z,15E,18S,19R,23S)-7-((2S,3S,4R,5E,7E)-2,4-bis(tert-butyldimethylsilyloxy)-9-hydroxy-3,6-dimethylnona-5,7-dienyl)-3-(tert-butyldimethylsilyloxy)-11-methoxy-2,18,21,21,23-pentamethyl-6,20,22-trioxabicyclo[17.3.1]tricoso-13,15-dien-5-one 238

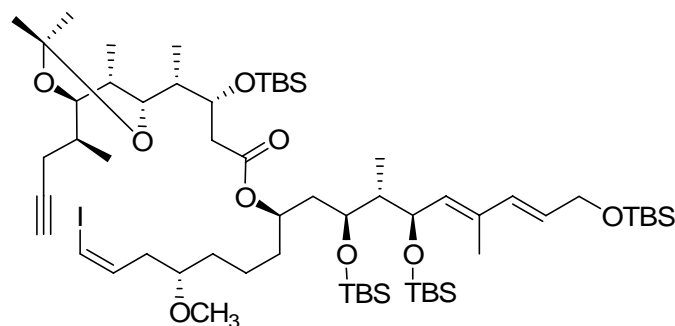


C₅₅H₁₀₄O₉Si₃
Exact Mass: 992,6988
Mol. Wt.: 993,6654

To a solution of the TBS ether (12.0 mg, 10.8 μmol , 1.0 eq.) in THF/H₂O (4:1, 100 μL) was added NaIO₄ (13.9 mg, 65.0 μmol , 6.0 eq.) as solid at room temperature. The reaction mixture was stirred at RT for 15 h and H₂O (1 mL) and DCM (2 mL) were added. The organic layer was separated and the aqueous layer was extracted with DCM (3 \times 2 mL). The combined organics were dried over MgSO₄, filtered and evaporated *in vacuo*. Silica gel chromatography (hexanes / EtOAc, gradient elution, 9:1 to 2:1) afforded the alcohol (9.0 mg, 9.1 μmol , 84%) as a colorless oil.

R_f = 0.15 (hexanes / EtOAc = 9:1); ¹H NMR (600 MHz, CDCl₃) δ = -0.05 (s, 3H), -0.02 (s, 6H), 0.02 (s, 3H), 0.04 (s, 3H), 0.05 (s, 3H), 0.69 (d, J = 7.1 Hz, 3H), 0.85 (s, 9H), 0.87 (d, J = 6.0 Hz, 3H), 0.88 (s, 9H), 0.89 (s, 9H), 0.90 (d, J = 6.8 Hz, 3H), 0.99 (d, J = 6.8 Hz, 3H), 1.35 (s, 3H), 1.37 (s, 3H), 1.45-1.57 (m, 6H), 1.63 (m, 1H), 1.74-1.83 (m, 5H), 1.77 (s, 3H), 2.09 (m, 1H), 2.18 (m, 3H), 2.33 (m, 1H), 2.50 (m, 1H), 3.31-3.46 (m, 3H), 3.35 (s, 3H), 4.17-4.23 (m, 3H), 4.21 (d, J = 6.0 Hz, 2H), 4.80 (m, 1H), 5.34 (d, J = 8.7 Hz, 1H), 5.46 (m, 1H), 5.66 (m, 1H), 5.79 (dt, J = 15.8, 5.8 Hz, 1H), 6.00 (t, J = 10.7 Hz, 1H), 6.25 (d, J = 15.1 Hz, 1H), 6.43 (dd, J = 14.3, 11.7 Hz, 1H); ¹³C NMR (75 MHz, CDCl₃) δ = -4.9, -4.8, -4.4, -4.3, -4.0, -3.7, 6.0, 9.2, 13.4, 18.0, 18.8, 19.6, 21.0, 25.9, 26.0, 30.1, 31.0, 32.0, 32.3, 33.4, 33.8, 35.0, 40.6, 46.3, 57.1, 63.7, 63.8, 67.7, 71.3, 72.2, 78.8, 80.0, 99.0, 126.0, 126.4, 127.3, 129.9, 132.6, 135.8, 135.9, 172.5; HRMS calculated for C₅₅H₁₀₄O₉Si₃Na [M+Na]⁺: 1015.6886, found: 1015.6880.

(3*R*,4*S*)-((1*Z*,4*S*,8*R*,10*S*,11*S*,12*R*,13*E*,15*E*)-10,12,17-tris(tert-butyldimethylsilyloxy)-1-iodo-4-methoxy-11,14-dimethylheptadeca-1,13,15-trien-8-yl) 3-(tert-butyldimethylsilyloxy)-4-((4*R*,5*S*,6*R*)-2,2,5-trimethyl-6-((*S*)-pent-4-yn-2-yl)-1,3-dioxan-4-yl)pentanoate 239

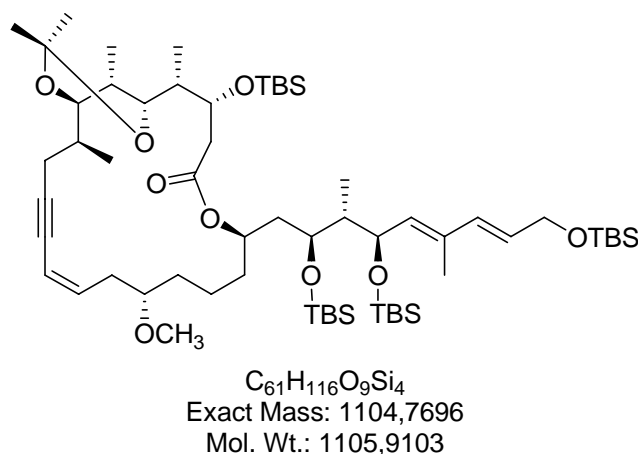


C₆₁H₁₁₇IO₉Si₄
Exact Mass: 1232,6819
Mol. Wt.: 1233,8228

Et₃N (10.0 μL, 69.0 μmol, 2.5 eq.) and 2,4,6-trichlorobenzoyl chloride (11.0 μL, 69.0 μmol, 2.5 eq.) were added to a stirred solution of alcohol (22.8 mg, 27.6 μmol, 1.0 eq.), the acid (22.0 mg, 51.6 μmol, 1.9 eq.), DMAP (16.8 mg, 138 μmol, 5.0 eq.) in toluene (1.0 mL) at 0 °C. The resulting white slurry was stirred at room temperature for 20 minutes before being quenched with pH7 phosphate buffer (1.0 mL) and H₂O (1.0 mL) at 0 °C. Et₂O (3 mL) was added and the layers were separated. The aqueous layer was extracted with Et₂O (3 × 5 mL). The combined organic extracts were dried (MgSO₄) and concentrated *in vacuo*. Flash column chromatography (hexanes / Et₂O = 9:1) afforded the ester (28.0 mg, 22.7 μmol, 82%) as a colorless oil.

$R_f = 0.50$ (hexanes / Et₂O = 9:1); $[\alpha]_D^{20} = -9.3$ ($c = 1.09$, CHCl₃); ¹H NMR (600 MHz, CDCl₃) $\delta = -0.05$ (s, 3H), -0.04 (s, 3H), 0.008 (s, 3H), 0.03 (s, 3H), 0.04 (s, 3H), 0.07 (s, 6H), 0.09 (s, 3H), 0.66 (d, $J = 7.3$ Hz, 3H), 0.85 (s, 9H), 0.86 (s, 9H), 0.88 (s, 9H), 0.91 (s, 9H), 0.92 (d, $J = 6.6$ Hz, 3H), 0.95 (d, $J = 6.6$ Hz, 3H), 1.06 (d, $J = 6.6$ Hz, 3H), 1.35 (s, 3H), 1.38 (s, 3H), 1.42 (m, 2H), 1.56 (m, 6H), 1.67 (m, 1H), 1.75 (s, 3H), 1.77 (m, 2H), 1.84 (m, 1H), 1.91 (t, $J = 2.6$ Hz, 1H), 1.96 (m, 1H), 2.07 (d, $J = 15.0$ Hz, 1H), 2.21 (m, 1H), 2.36 (m, 3H), 3.29 (m, 1H), 3.34 (s, 3H), 3.37 (dd, $J = 9.0, 1.6$ Hz, 1H), 3.44 (dd, $J = 9.5, 1.5$ Hz, 1H), 4.15 (t, $J = 9.2$ Hz, 1H), 4.20 (dt, $J = 10.4, 2.4$ Hz, 1H), 4.24 (d, $J = 6.2$ Hz, 2H), 4.25 (m, 1H), 4.85 (m, 1H), 5.27 (d, $J = 9.2$ Hz, 1H), 5.70 (dt, $J = 15.8, 5.5$ Hz, 1H), 6.21 (d, $J = 15.8$ Hz, 1H), 6.24 (dd, $J = 14.1, 6.8$ Hz, 1H), 6.29 (d, $J = 7.3$ Hz, 1H); ¹³C NMR (100 MHz, CDCl₃) $\delta = -5.1, -5.0, -4.8, -4.7, -4.5, -4.3, -4.0, -3.6, 5.6, 9.2, 10.2, 13.5, 16.4, 18.0, 18.1, 18.5, 19.4, 20.8, 20.2, 25.9, 26.0, 26.1, 30.0, 31.3, 33.0, 33.5, 34.4, 34.9, 37.7, 38.4, 40.4, 46.4, 56.7, 64.1, 67.6, 68.0, 69.9, 71.2, 72.3, 75.9, 79.4, 81.9, 84.2, 99.1, 128.0, 133.0, 134.3, 134.9, 137.5, 171.7$; HRMS calculated for C₆₁H₁₁₇IO₉Si₄Na [M+Na]⁺: 1255.6717, found: 1255.6777.

(1R,2S,3R,7R,11S,18S,19R,23S,Z)-3-(tert-butyldimethylsilyloxy)-11-methoxy-2,18,21,21,23-pentamethyl-7-((2S,3S,4R,5E,7E)-2,4,9-tris(tert-butyldimethylsilyloxy)-3,6-dimethylnona-5,7-dienyl)-6,20,22-trioxabicyclo[17.3.1]tricos-13-en-15-yn-5-one 240



A solution of the iodide (26.7 mg, 21.6 μmol , 1.0 eq.) and $i\text{Pr}_2\text{NEt}$ (113 μl , 648 μmol , 30 eq.) in DMF (11 ml) was degassed by freeze-pump-thaw cycle (three times). After addition of CuI (8.26 mg, 43.2 μmol , 2.0 eq.), the mixture was vigorously stirred at room temperature in the dark for 30 min, producing a yellow solution. $\text{Pd}(\text{dba})_3$ (9.89 mg, 10.8 μmol , 0.5 eq.) was added to the resulting solution. The reaction mixture was stirred at room temperature for 70 min in the dark, diluted with Et_2O (12 mL) and quenched with sat. aq. NH_4Cl (6 mL) and water (6 mL) at 0 $^\circ\text{C}$. The mixture was vigorously stirred at room temperature for 1 h. The layers were separated, and the aqueous layers were extracted with Et_2O (4×10 mL). The combined organic extracts were washed with brine (6 mL), dried over MgSO_4 and concentrated. The residue was purified by flash column chromatography on silica gel (hexanes / Et_2O = 20:1) to give the desired product (7.20 mg, 6.50 μmol , 30%) as a colorless oil.

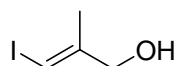
R_f = 0.48 (hexanes / Et_2O = 9:1); ^1H NMR (600 MHz, CDCl_3) δ = -0.05 (s, 3H), 0.01 (s, 3H), 0.02 (s, 3H), 0.03 (s, 3H), 0.04 (s, 3H), 0.07 (s, 6H), 0.08 (s, 3H), 0.69 (d, J = 7.0 Hz, 3H), 0.87 (s, 27H), 0.91 (s, 9H), 0.93 (d, J = 6.8 Hz, 3H), 0.94 (d, J = 6.8 Hz, 3H), 1.04 (d, J = 6.6 Hz, 3H), 1.31 (m, 2H), 1.36 (s, 3H), 1.37 (s, 3H), 1.48 (m, 2H), 1.58 (m, 1H), 1.65 (m, 1H), 1.74 (s, 3H), 1.70-1.76 (m, 3H), 1.78-1.86 (m, 3H), 2.29-2.40 (m, 3H), 2.43-2.49 (m, 3H), 3.33 (m, 1H), 3.33 (s, 3H), 3.58 (m, 2H), 4.20 (m, 3H), 4.24 (d, J = 4.4 Hz, 2H), 4.81 (m, 1H), 5.28 (d, J = 9.2 Hz, 1H), 5.52 (d, J = 10.6 Hz, 1H), 5.70 (dt, J = 15.8, 5.3 Hz, 1H), 5.92 (m, 1H), 6.20 (d, J = 15.8 Hz, 1H); ^{13}C NMR (75 MHz, CDCl_3) δ = -5.1, -4.8, -4.5, -4.4, -4.2, -4.0, -3.7, 6.0, 9.4, 13.4, 16.9, 18.1, 18.5, 19.7, 20.3, 22.3, 25.9, 26.0, 26.1, 29.7, 30.1, 31.5, 32.3, 32.8, 33.4, 34.0, 35.7, 39.7, 40.9, 46.6, 56.5, 64.1, 69.0, 71.2, 73.5, 78.9, 80.0, 91.9, 99.1, 111.2, 127.9, 132.9, 134.3, 134.9, 138.0, 171.5; HRMS calculated for $C_{61}H_{116}O_9Si_4\text{Na}$ $[\text{M}+\text{Na}]^+$: 1127.7594, found: 1127.7599.

8.5 Selective Deprotection of Silyl ethers with NaIO₄

8.5.1 General procedure for deprotection of silyl ethers

To a solution of the silyl ether (0.1 M) in THF/H₂O (4:1) was added NaIO₄ (6.0 eq.) as solid at room temperature. After the completion of the reaction (TLC control), **workup 1**; H₂O and DCM were added. The organic layer was separated and the aqueous layer was extracted with DCM. The combined organic phases were dried over MgSO₄, filtered and evaporated *in vacuo*; **workup 2**: ether and MgSO₄ were added. The mixture was stirred for 5 min. After filtration, the organic phases were evaporated *in vacuo*. Silica gel chromatography (hexanes / EtOAc, gradient elution, 9:1 to 2:1) afforded the alcohol.

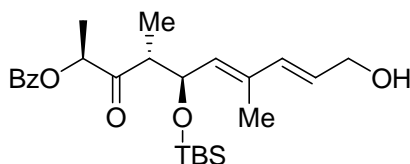
(*E*)-3-iodo-2-methylprop-2-en-1-ol **90**



C₄H₇IO
Exact Mass: 197,9542
Mol. Wt.: 198,0023

R_f = 0.20 (hexanes / EtOAc 9:1); ¹H NMR (400 MHz, CDCl₃) δ = 1.58 (m, 1H), 1.83 (s, 3H), 4.12 (d, *J* = 4.1 Hz, 2H), 6.28 (s, 1H); ¹³C NMR (100 MHz, CDCl₃) δ = 21.4, 67.2, 77.3, 147.2. Spectroscopic data were identical to those previously reported.

(2*S*,4*R*,5*R*,6*E*,8*E*)-5-(*tert*-butyldimethylsilyloxy)-10-hydroxy-4,7-dimethyl-3-oxodeca-6,8-dien-2-yl benzoate **246**

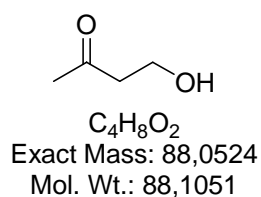


C₂₅H₃₈O₅Si
Exact Mass: 446,2489
Mol. Wt.: 446,6517

R_f = 0.18 (hexanes / EtOAc = 4:1); [α]_D²⁰ = +12.2 (*c* = 0.32, CHCl₃); ¹H NMR (400 MHz, CDCl₃) δ = -0.06 (s, 3H), -0.04 (s, 3H), 0.80 (s, 9H), 0.99 (d, *J* = 7.1 Hz, 3H), 1.41 (t, *J* = 4.8

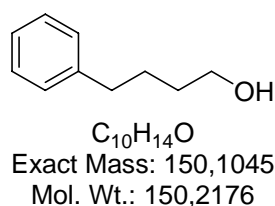
Hz, 1H) 1.52 (d, $J = 7.1$ Hz, 3H), 1.79 (s, 3H), 2.90 (m, 1H), 4.21 (t, $J = 5.1$ 2H), 4.73 (t, $J = 9.4$ Hz, 1H), 5.31 (d, $J = 9.2$ Hz, 1H), 5.40 (q, $J = 7.0$ Hz, 1H), 5.81 (dt, $J = 15.8, 5.8$ Hz, 1H), 6.24 (d, $J = 15.8$ Hz, 1H), 7.44 (tm, $J = 7.6$ Hz, 2H), 7.56 (tm, $J = 7.4$ Hz, 1H), 8.07 (dm, $J = 7.1$ Hz, 2H); ^{13}C NMR (100 MHz, CDCl_3) $\delta = -4.9, -4.4, 13.5, 13.9, 15.2, 18.0, 25.8, 49.5, 63.7, 71.5, 75.4, 127.9, 128.4$ (2C), 129.8, 133.2, 133.6, 134.4, 135.4, 165.8, 209.2; HRMS calculated for $\text{C}_{25}\text{H}_{38}\text{O}_5\text{SiNa}$ $[\text{M}+\text{Na}]^+$: 469.2386, found: 469.2386.

4-hydroxybutan-2-one 247

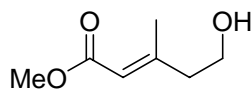


$R_f = 0.12$ (hexanes / EtOAc = 1:1); ^1H NMR (400 MHz, CDCl_3) $\delta = 2.18$ (s, 3H), 2.69 (t, $J = 5.3$ Hz, 2H), 3.83 (t, $J = 5.3$ Hz, 2H); ^{13}C NMR (100 MHz, CDCl_3) $\delta = 30.5, 45.3, 57.8, 209.5$. Spectroscopic data were identical to those previously reported.

4-phenylbutan-1-ol 248

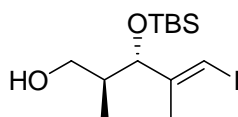


$R_f = 0.13$ (hexanes / EtOAc = 9:1); ^1H NMR (400 MHz, CDCl_3) $\delta = 1.33$ (s, 1H), 1.60 (m, 2H), 1.69 (m, 2H), 2.65 (t, $J = 7.6$ Hz, 2H), 3.65 (t, $J = 6.4$ Hz, 2H), 7.17 (m, 3H), 7.27 (m, 2H); ^{13}C NMR (100 MHz, CDCl_3) $\delta = 27.5, 32.3, 35.6, 62.8, 125.8, 128.3, 128.4, 142.3$. Spectroscopic data were identical to those previously reported.

(E)-methyl 5-hydroxy-3-methylpent-2-enoate 249

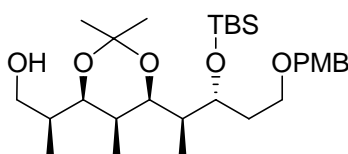
$C_7H_{12}O_3$
Exact Mass: 144,0786
Mol. Wt.: 144,1684

$R_f = 0.35$ (hexanes / EtOAc = 2:1); 1H NMR (300 MHz, $CDCl_3$) $\delta = 2.19$ (d, $J = 1.3$ Hz, 3H), 2.40 (dt, $J = 6.4, 1.0$ Hz, 2H), 3.68 (s, 3H), 3.78, (t, $J = 6.3$ Hz, 2H), 5.74 (m, 1H); ^{13}C NMR (75 MHz, $CDCl_3$) $\delta = 18.8, 43.7, 50.9, 60.2, 117.3, 156.3, 166.9$. Spectroscopic data were identical to those previously reported.

(2S,3S,E)-3-(tert-butyldimethylsilyloxy)-5-iodo-2,4-dimethylpent-4-en-1-ol 250

$C_{13}H_{27}IO_2Si$
Exact Mass: 370,0825
Mol. Wt.: 370,3423

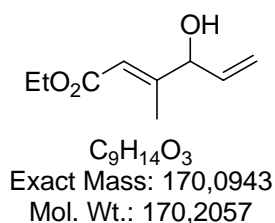
$R_f = 0.25$ (hexanes / EtOAc = 9:1); 1H NMR (300 MHz, $CDCl_3$) $\delta = -0.01$ (s, 3H), 0.07 (s, 3H), 0.79 (d, $J = 7.0$ Hz, 3H), 0.88 (s, 9H), 1.77 (s, 3H), 1.84 (m, 1H), 2.45 (t, $J = 5.6$ Hz, 1H), 3.61 (t, $J = 5.2$ Hz, 2H), 4.01 (d, $J = 7.9$ Hz, 1H), 6.19 (s, 1H); ^{13}C NMR (75 MHz, $CDCl_3$) $\delta = -5.3, -4.7, 14.0, 18.1, 19.5, 25.8, 38.8, 66.2, 79.3, 82.8, 148.9$; HRMS calculated for $C_{13}H_{27}IO_2SiNa$ $[M+Na]^+$: 393.0723, found: 393.0728.

(S)-2-((4R,5S,6R)-6-((2S,3R)-3-(tert-butyldimethylsilyloxy)-5-(4-methoxybenzyloxy)pentan-2-yl)-2,2,5-trimethyl-1,3-dioxan-4-yl)propan-1-ol 251

$C_{29}H_{52}O_6Si$
Exact Mass: 524,3533
Mol. Wt.: 524,8051

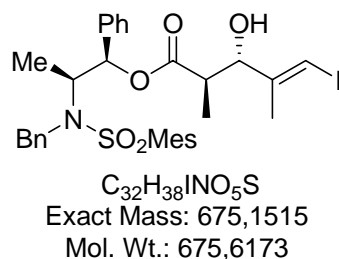
$R_f = 0.47$ (hexanes / EtOAc = 4:1); $[\alpha]_D^{20} = +9.8$ ($c = 1.40$, CHCl_3); $^1\text{H NMR}$ (300 MHz, CDCl_3) $\delta = 0.04$ (s, 3H), 0.06 (s, 3H), 0.87 (s, 9H), 0.89 (d, $J = 6.6$ Hz, 3H), 0.91 (d, $J = 6.6$ Hz, 3H), 0.96 (d, $J = 6.6$ Hz, 3H), 1.10 (m, 1H), 1.35 (s, 3H); 1.38 (s, 3H), 1.49-1.67 (m, 4H), 1.80 (m, 1H), 3.28 (m, 2H), 3.43 (dd, $J = 9.7$ 1.8 Hz, 1H), 3.52 (m, 3H), 3.80 (s, 3H), 3.93 (m, 1H), 4.37 (s, 2H), 6.88 (m, 2H), 7.24 (m, 2H); $^{13}\text{C NMR}$ (75 MHz, CDCl_3) $\delta = -4.7$, -4.0 , 5.8, 9.9, 14.1, 18.1, 19.6, 25.9, 30.1, 30.6, 32.0, 36.5, 40.1, 55.4, 63.9, 67.3, 67.4, 72.8, 75.9, 99.2, 113.8, 129.4, 130.8, 159.3. HRMS calculated for $\text{C}_{29}\text{H}_{52}\text{O}_6\text{SiNa}$ $[\text{M}+\text{Na}]^+$: 547.3431, found: 547.3433.

(E)-ethyl 4-hydroxy-3-methylhexa-2,5-dienoate 258



$R_f = 0.33$ (hexanes / EtOAc = 6:1); $^1\text{H NMR}$ (400 MHz, CDCl_3) $\delta = 1.26$ (t, $J = 7.1$ Hz, 3H), 1.99 (d, $J = 4.1$ Hz, 1H), 2.08 (s, 3H), 4.15 (q, $J = 7.1$ Hz, 2H), 4.55 (m, 1H), 5.23 (dm, $J = 10.2$ Hz, 1H), 5.34 (dm, $J = 17.3$ Hz, 1H), 5.79 (m, 1H), 6.00 (s, 1H); $^{13}\text{C NMR}$ (100 MHz, CDCl_3) $\delta = 14.3$, 15.1, 59.9, 77.6, 115.4, 117.4, 137.6, 157.8, 166.9.

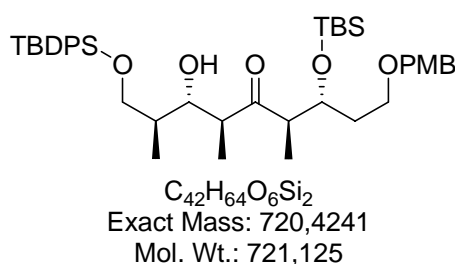
(2R,3S,E)-((1R,2S)-2-(N-benzyl-2,4,6-trimethylphenylsulfonamido)-1-phenylpropyl)-3-hydroxy-5-iodo-2,4-dimethylpent-4-enoate 114



$R_f = 0.43$ (hexanes / EtOAc = 8:1); $[\alpha]_D^{20} = +38.9$ ($c = 0.97$, CHCl_3); $^1\text{H NMR}$ (300 MHz, CDCl_3) $\delta = 0.95$ (d, $J = 7.2$ Hz, 3H), 1.17 (d, $J = 7.0$ Hz, 3H), 1.81 (d, $J = 1.1$ Hz, 3H), 2.27 (s,

3H), 2.50 (s, 6H), 2.54-2.65 (m, 1H), 2.77 (d, $J = 3.8$ Hz, 1H, OH), 4.10 (dq, $J = 4.1, 7.0$ Hz, 1H), 4.24 (dd, $J = 3.4$ Hz, 1H), 4.56 (A of ABq, $J_{AB}=16.6$, 1H), 4.74 (B of ABq, $J_{AB}=16.6$, 1H), 5.85 (d, $J = 4.1$ Hz, 1H), 6.29 (s, 1H), 6.82-6.85 (m, 2H), 6.87 (s, 2H), 7.13-7.35 (m, 8H); ^{13}C NMR (75 MHz, CDCl_3) $\delta = 13.4, 14.1, 18.9, 20.9, 23.0, 43.3, 48.3, 56.8, 78.6, 78.7, 81.2, 125.9, 127.2, 127.6, 128.0, 128.4, 128.5, 132.2, 133.4, 138.1, 138.6, 140.3, 142.6, 146.9, 174.1$; HRMS calculated for $\text{C}_{32}\text{H}_{38}\text{INO}_5\text{SNa}$ $[\text{M}+\text{Na}]^+$: 698.1413, found: 698.1409.

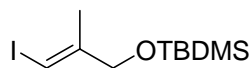
(5*R*,6*R*,8*S*,9*S*,10*S*)-9-hydroxy-5-(2-(4-methoxybenzyloxy)ethyl)-2,2,3,3,6,8,10,14,14-nona-methyl-13,13-diphenyl-4,12-dioxo-3,13-disilapentadecan-7-one 259



$R_f = 0.32$ (hexanes / EtOAc = 9:1); $[\alpha]_D^{20} = +2.9$ ($c = 0.43$, CHCl_3); ^1H NMR (400 MHz, CDCl_3) $\delta = 0.08$ (s, 3H), 0.02 (s, 3H), 0.84 (s, 9H), 0.98 (d, $J = 7.1$ Hz, 3H), 1.04 (s, 9H), 1.04 (d, $J = 7.0$ Hz, 3H), 1.05 (d, $J = 6.8$ Hz, 3H), 1.70 (m, 2H), 1.84 (m, 1H), 2.96 (m, 2H), 3.31 (d, $J = 6.1$ Hz, 1H, OH), 3.50 (m, 2H), 3.59 (m, 1H), 3.71 (m, 2H), 3.77 (s, 3H), 4.17 (m, 1H), 4.39 (s, 2H), 6.83 (d, $J = 8.6$ Hz, 2H), 7.22 (d, $J = 8.1$ Hz, 2H), 7.39 (m, 6H), 7.67 (m, 4H); ^{13}C NMR (100 MHz, CDCl_3) $\delta = -4.8, -4.5, 10.9, 14.2, 15.2, 18.0, 19.2, 25.9, 26.9, 32.7, 37.2, 48.9, 51.9, 55.3, 65.7, 66.3, 69.9, 72.6, 113.8, 127.7, 129.3, 129.7, 130.7, 133.4, 135.6, 135.7, 159.1, 217.5$; HRMS calculated for $\text{C}_{42}\text{H}_{64}\text{O}_6\text{Si}_2\text{Na}$ $[\text{M}+\text{Na}]^+$: 743.4139, found: 743.4143.

8.5.2 Preparation of Silyl Ethers

(*E*)-*tert*-butyl(3-iodo-2-methylallyloxy)dimethylsilane 241

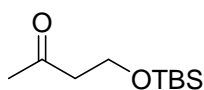


C₁₀H₂₁IOSi
Exact Mass: 312,0406
Molr. Wt.: 312,2631

To a stirred solution (-78 °C) of alcohol (130 mg, 0.656 mmol, 1.0 eq.) in CH₂Cl₂ (2 mL) was added 2,6-lutidine (132 μL, 1.12 mmol, 1.7 eq.) and TBSOTf (198 μL, 0.853 mmol, 1.3 eq.). The mixture was stirred at -78 °C for 30 min. The cooling bath was removed and the reaction quenched with sat. aqueous NaHCO₃ (3 mL). The mixture was warmed to room temperature. CH₂Cl₂ (10 mL) were added. The organic layer was separated and the aqueous layer was extracted with CH₂Cl₂ (3 × 5 mL). The combined organics were dried over MgSO₄, filtered and evaporated *in vacuo*. Silica gel chromatography (hexanes / Et₂O 9:1) afforded the desired TBS-ether (194 mg, 0.621 mmol, 91%) as a colorless oil.

R_f = 0.91 (hexanes / EtOAc = 9:1); ¹H NMR (400 MHz, CDCl₃) δ = 0.06 (s, 1H), 0.90 (s, 9H), 1.77 (s, 3H), 4.09 (s, 2H), 6.19 (s, 1H); ¹³C NMR (100 MHz, CDCl₃) δ = -5.4, 18.4, 21.2, 25.9, 67.1, 75.9, 146.9.

4-(*tert*-butyldimethylsilyloxy)butan-2-one 242



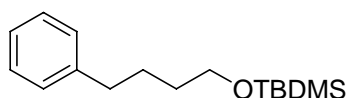
C₁₀H₂₂O₂Si
Exact Mass: 202,1389
Mol. Wt.: 202,366

To a stirred solution (-78 °C) of alcohol (86.0 mg, 0.976 mmol, 1.0 eq.) in CH₂Cl₂ (1 mL) was added 2,6-lutidine (197 μL, 1.66 mmol, 1.7 eq.) and TBSOTf (295 μL, 1.27 mmol, 1.3 eq.). The mixture was stirred at -78 °C for 30 min. The cooling bath was removed and the reaction quenched with sat. aqueous NaHCO₃ (3 mL). The mixture was warmed to room temperature. CH₂Cl₂ (10 mL) were added. The organic layer was separated and the aqueous layer was extracted with CH₂Cl₂ (3 × 5 mL). The combined organics were dried over MgSO₄, filtered

and evaporated *in vacuo*. Silica gel chromatography (hexanes / Et₂O 9:1) afforded the desired TBS-ether (184 mg, 0.909 mmol, 93%) as a colorless oil.

R_f = 0.57 (hexanes / EtOAc = 9:1); ¹H NMR (400 MHz, CDCl₃) δ = 0.04 (s, 6H), 0.86 (s, 9H), 2.16 (s, 3H), 2.60 (t, J = 6.4 Hz, 2H), 3.87 (t, J = 6.4 Hz, 2H); ¹³C NMR (100 MHz, CDCl₃) δ = -5.4, 18.2, 25.9, 30.8, 46.6, 58.9, 208.1.

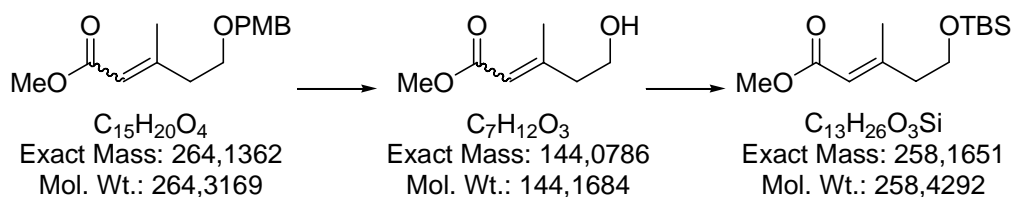
tert-Butyldimethyl(4-phenylbutoxy)silane 243



C₁₆H₂₈OSi
Exact Mass: 264,1909
Mol. Wt.: 264,4784

To a stirred solution (-78 °C) of alcohol (114 mg, 0.759 mmol, 1.0 eq.) in CH₂Cl₂ (2 mL) was added 2,6-lutidine (153 μ L, 1.29 mmol, 1.7 eq.) and TBSOTf (229 μ L, 0.987 mmol, 1.3 eq.). The mixture was stirred at -78 °C for 30 min. The cooling bath was removed and the reaction quenched with sat. aqueous NaHCO₃ (3 mL). The mixture was warmed to room temperature. CH₂Cl₂ (10 mL) were added. The organic layer was separated and the aqueous layer was extracted with CH₂Cl₂ (3 \times 5 mL). The combined organics were dried over MgSO₄, filtered and evaporated *in vacuo*. Silica gel chromatography (hexanes / Et₂O 9:1) afforded the desired TBS-ether (198 mg, 0.749 mmol, 99%) as a colorless oil.

R_f = 0.57 (hexanes / EtOAc = 9:1); ¹H NMR (400 MHz, CDCl₃) δ = 0.04 (s, 6H), 0.89 (s, 9H), 1.56 (m, 2H), 1.67 (m, 2H), 2.63 (t, J = 7.6 Hz, 2H), 3.63 (t, J = 6.4 Hz, 2H), 7.17 (m, 3H), 7.27 (m, 2H); ¹³C NMR (100 MHz, CDCl₃) δ = -5.2, 18.4, 26.0, 27.7, 32.5, 35.7, 63.0, 125.7, 128.3, 128.4, 142.7.

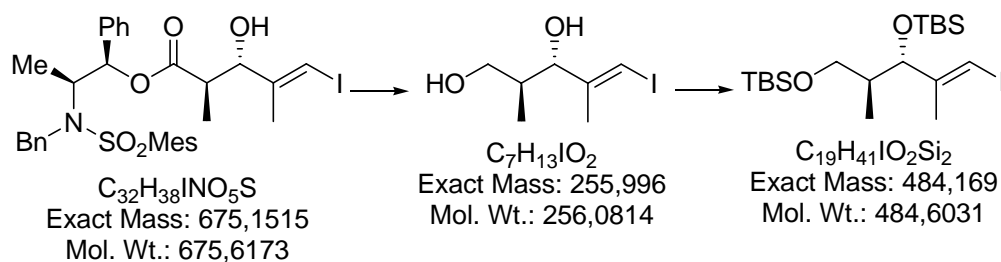
(E)-Methyl 5-(tert-butyldimethylsilyloxy)-3-methylpent-2-enoate 244

The PMB ether (136 mg, 0.514 μmol , 1.0 eq.) was dissolved in CH_2Cl_2 / aq. pH 7 buffer (10:1, 3.3 mL) under argon atmosphere. Then DDQ (350 mg, 1.54 μmol , 3.0 eq.) was added fast and the resulting suspension was stirred for 60 min at ambient temperature. The reaction mixture was quenched by addition of 7 mL saturated, aqueous NaHCO_3 solution. The organic layer was separated and the aqueous phase was extracted with CH_2Cl_2 (3×5 mL). Then the combined organic layer was dried over MgSO_4 , filtered and the solvent was removed under reduced pressure, before the crude product was purified by flash chromatography on silica gel (hexanes / EtOAc = 9:1 to 1:1) to give the desired free alcohol (59.3 mg, 0.411 mmol, 80%, *E/Z*: 3:1).

$R_f = 0.35$ (hexanes / EtOAc = 2:1); ^1H NMR (300 MHz, CDCl_3) $\delta = 2.19$ (d, $J = 1.3$ Hz, 3H), 2.40 (dt, $J = 6.4$, 1.0 Hz, 2H), 3.68 (s, 3H), 3.78, (t, $J = 6.3$ Hz, 2H), 5.74 (m, 1H); ^{13}C NMR (75 MHz, CDCl_3) $\delta = 18.8$, 43.7, 50.9, 60.2, 117.3, 156.3, 166.9.

To a stirred solution (-78 $^\circ\text{C}$) of alcohol (22.8 mg, 0.158 mmol, 1.0 eq.) in CH_2Cl_2 (200 μL) was added 2,6-lutidine (32.0 μL , 0.269 mmol, 1.7 eq.) and TBSOTf (47.6 μL , 0.987 mmol, 1.3 eq.). The mixture was stirred at -78 $^\circ\text{C}$ for 30 min. The cooling bath was removed and the reaction quenched with sat. aqueous NaHCO_3 (2 mL). The mixture was warmed to room temperature. CH_2Cl_2 (5 mL) were added. The organic layer was separated and the aqueous layer was extracted with CH_2Cl_2 (3×3 mL). The combined organics were dried over MgSO_4 , filtered and evaporated *in vacuo*. Silica gel chromatography (hexanes / Et₂O 20:1) afforded the desired TBS-ether (36.7 mg, 0.142 mmol, 90%; 16.0 mg for *E* double bond) as a colorless oil.

^1H NMR (400 MHz, CDCl_3) $\delta = 0.03$ (s, 6H), 0.87 (s, 9H), 2.17 (s, 3H), 2.33 (t, $J = 6.6$ Hz, 2H), 3.67 (s, 3H), 3.73, (t, $J = 6.6$ Hz, 2H), 5.68 (s, 1H); ^{13}C NMR (100 MHz, CDCl_3) $\delta = -5.4$, 18.3, 19.2, 25.9, 44.0, 50.8, 61.3, 116.8, 157.3, 167.1.

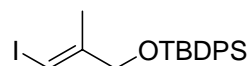
(5*S*,6*S*)-5-((*E*)-1-Iodoprop-1-en-2-yl)-2,2,3,3,6,9,9,10,10-nonamethyl-4,8-dioxa-3,9-disilaundecane 245

To a solution of the ester (124 mg, 0.184 mmol, 1.0 eq.) in THF (2 mL) was added $BH_3 \cdot SMe_2$ (19.4 μ L, 0.184 mmol, 1.0 eq.) at $-20^\circ C$. The reaction mixture was warmed to room temperature and stirred for 1 h and quenched with MeOH (0.2 mL), pH7 buffer (1 mL) and 30% H_2O_2 (0.1 mL) and stirred for 1 h at RT. The organic layer was separated and the aqueous phase was extracted with EtOAc (3×5 mL). Then the combined organic layer was dried over $MgSO_4$, filtered and the solvent was removed under reduced pressure, before the crude product was purified by flash chromatography on silica gel (hexanes / EtOAc = 2:1 to 1:1) to give the desired free alcohol (36.0 mg, 0.141 mmol, 78%).

$R_f = 0.24$ (hexanes / EtOAc = 2:1); $[\alpha]_D^{20} = +18.3$ ($c = 0.58$, $CHCl_3$); 1H NMR (300 MHz, $CDCl_3$) $\delta = 0.74$ (d, $J = 7.0$ Hz, 3H), 1.81 (s, 3H), 1.90 (m, 1H), 3.18 (m, 2H), 3.62 (m, 1H), 3.72 (m, 1H), 4.06 (d, $J = 8.5$ Hz, 1H), 6.27 (s, 1H); ^{13}C NMR (75 MHz, $CDCl_3$) $\delta = 13.6$, 19.1, 37.5, 67.6, 80.1, 83.0, 148.8.

To a stirred solution ($-78^\circ C$) of the diol (21.0 mg, 82.0 μ mol, 1.0 eq.) in CH_2Cl_2 (200 μ L) was added 2,6-lutidine (33.0 μ L, 279 μ mol, 3.4 eq.) and TBSOTf (50.0 μ L, 213 μ mol, 2.6 eq.). The mixture was stirred at $-78^\circ C$ for 30 min. The cooling bath was removed and the reaction quenched with sat. aqueous $NaHCO_3$ (3 mL). The mixture was warmed to room temperature. CH_2Cl_2 (6 mL) were added. The organic layer was separated and the aqueous layer was extracted with CH_2Cl_2 (3×3 mL). The combined organics were dried over $MgSO_4$, filtered and evaporated *in vacuo*. Silica gel chromatography (hexanes / Et_2O 9:1) afforded the desired TBS-ether (33.1 mg, 68.3 μ mol, 90%) as colorless oil.

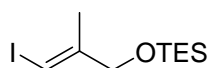
1H NMR (300 MHz, $CDCl_3$) $\delta = -0.05$ (s, 3H), -0.02 (s, 9H), 0.72 (d, $J = 7.0$ Hz, 3H), 0.86 (9H), 0.88 (s, 9H), 1.68 (m, 1H), 1.73 (s, 3H), 3.60 (m, 2H), 3.99 (d, $J = 8.7$ Hz, 1H), 6.09 (s, 1H); ^{13}C NMR (75 MHz, $CDCl_3$) $\delta = -5.4$, -5.3 , -4.9 , 13.6, 18.2, 18.4, 19.0, 25.8, 26.0, 40.0, 64.3, 78.5, 78.8, 149.6.

(E)-tert-butyl(3-iodo-2-methylallyloxy)diphenylsilane 252

C₂₀H₂₅IOSi
Exact Mass: 436,0719
Mol. Wt.: 436,4019

A flask containing the alcohol (200 mg, 1.01 mmol, 1.0 eq.), imidazol (89.0 mg, 1.31 mmol, 1.3 eq.) and TBDPSCI (270 μ L, 1.04 mmol, 1.0 eq.) was charged with argon and abs. DCM (10 ml) was added. The reaction mixture was stirred at RT for 60 min. Sat. aq. NaHCO₃ (5 mL) were added, the organic phase separated, and the aq. phase thoroughly extracted with DCM (3 \times 10 mL). The combined organic extracts were dried over MgSO₄ and concentrated *in vacuo*. After flash chromatography (hexanes / Et₂O = 9:1) gave the TBDPS-ether (416 mg, 0.953 mmol, 94%) as yellow oil.

R_f = 0.91 (hexanes / Et₂O = 30:1); ¹H NMR (300 MHz, CDCl₃) δ = 1.06 (s, 9H), 1.75 (s, 3H), 4.12 (s, 2H), 6.28 (s, 1H), 7.41 (m, 6H), 7.65 (m, 4H); ¹³C NMR (75 MHz, CDCl₃) δ = 19.3, 21.3, 26.8, 67.7, 76.1, 127.8, 129.9, 133.3, 135.5, 146.4.

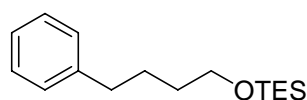
(E)-triethyl(3-iodo-2-methylallyloxy)silane 253

C₁₀H₂₁IOSi
Exact Mass: 312,0406
Molr. Wt.: 312,2631

To a stirred solution (-78 °C) of the alcohol (130 mg, 0.656 mmol, 1.0 eq.) in CH₂Cl₂ (2 mL) was added 2,6-lutidine (132 μ L, 1.12 mmol, 1.7 eq.) and TESOTf (193 μ L, 0.853 mmol, 1.3 eq.). The mixture was stirred at -78 °C for 30 min. The cooling bath was removed and the reaction quenched with sat. aqueous NaHCO₃ (3 mL). The mixture was warmed to room temperature. CH₂Cl₂ (10 mL) were added. The organic layer was separated and the aqueous layer was extracted with CH₂Cl₂ (3 \times 10 mL). The combined organics were dried over MgSO₄, filtered and evaporated *in vacuo*. Silica gel chromatography (hexanes / Et₂O 9:1) afforded the desired TES-ether (205 mg, 0.655 μ mol, 100%) as a colorless oil.

$R_f = 0.84$ (hexanes / EtOAc = 9:1); $^1\text{H NMR}$ (300 MHz, CDCl_3) $\delta = 0.60$ (q, $J = 8.1$ Hz, 6H), 0.95 (t, $J = 8.1$ Hz, 9H), 1.77 (s, 3H), 4.10 (s, 2H), 6.21 (s, 1H); $^{13}\text{C NMR}$ (75 MHz, CDCl_3) $\delta = 4.4, 6.7, 21.2, 66.8, 76.1, 146.8$.

Triethyl(4-phenylbutoxy)silane 254

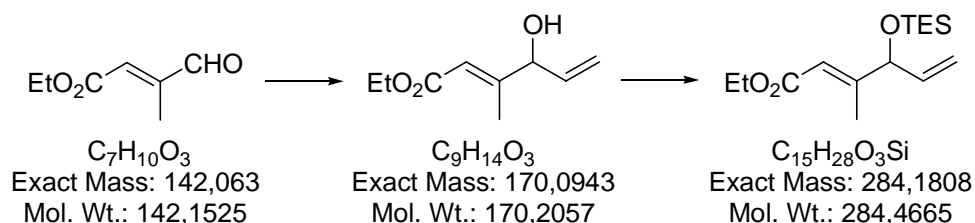


$\text{C}_{16}\text{H}_{28}\text{OSi}$
Exact Mass: 264,1909
Mol. Wt.: 264,4784

To a stirred solution (-78 °C) of alcohol (132 mg, 0.656 mmol, 1.0 eq.) in CH_2Cl_2 (2 mL) was added 2,6-lutidine (177 μL , 1.49 mmol, 1.7 eq.) and TESOTf (258 μL , 1.14 mmol, 1.3 eq.). The mixture was stirred at -78 °C for 30 min. The cooling bath was removed and the reaction quenched with sat. aqueous NaHCO_3 (3 mL). The mixture was warmed to room temperature. CH_2Cl_2 (10 mL) were added. The organic layer was separated and the aqueous layer was extracted with CH_2Cl_2 (3×10 mL). The combined organics were dried over MgSO_4 , filtered and evaporated *in vacuo*. Silica gel chromatography (hexanes / Et_2O 9:1) afforded the desired TES-ether (228 mg, 0.861 μmol , 98%) as a colorless oil.

$R_f = 0.53$ (hexanes / EtOAc = 9:1); $^1\text{H NMR}$ (400 MHz, CDCl_3) $\delta = 0.59$ (q, $J = 7.6$ Hz, 6H), 0.95 (t, $J = 8.1$ Hz, 9H), 1.57 (m, 2H), 1.67 (m, 2H), 2.62 (t, $J = 7.6$ Hz, 2H), 3.62 (t, $J = 6.4$ Hz, 2H), 7.16 (m, 3H), 7.26 (m, 2H); $^{13}\text{C NMR}$ (100 MHz, CDCl_3) $\delta = 4.5, 6.8, 27.7, 32.5, 35.7, 62.7, 125.7, 128.3, 128.4, 142.6$.

(*E*)-Ethyl 3-methyl-4-(triethylsilyloxy)hexa-2,5-dienoate 255



To a rapidly stirring solution of (*E*)-ethyl 3-methyl-4-oxobut-2-enoate (1.30 g, 9.15 mol, 1.0 eq.) in Et_2O (20 mL) under an argon atmosphere at -20 °C was added a solution of vinylmagnesium bromide in THF (1.0 M, 9.6 mL, 9.60 mmol, 1.05 eq.) over a period of 1 h.

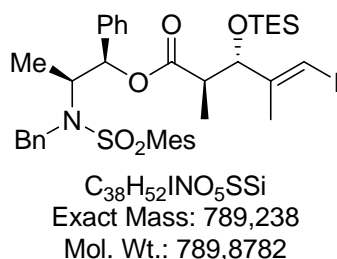
After the addition was complete, the mixture was stirred for 10 min and was then diluted with Et₂O (10 mL) and poured over 20 g of crushed ice. The pH of the solution is adjusted to 5-6, and the ether layer is separated and washed with water (15 mL) and brine (15 mL) and then dried over Na₂SO₄. Removal of solvent under reduced pressure affords alcohol as a pale yellow liquid (1.36 g, 7.99 mmol, 87%), which is sufficiently pure to use in the next step.

R_f = 0.33 (hexanes / EtOAc = 6:1); ¹H NMR (400 MHz, CDCl₃) δ = 1.26 (t, *J* = 7.1 Hz, 3H), 1.99 (d, *J* = 4.1 Hz, 1H), 2.08 (s, 3H), 4.15 (q, *J* = 7.1 Hz, 2H), 4.55 (m, 1H), 5.23 (dm, *J* = 10.2 Hz, 1H), 5.34 (dm, *J* = 17.3 Hz, 1H), 5.79 (m, 1H), 6.00 (s, 1H); ¹³C NMR (100 MHz, CDCl₃) δ = 14.3, 15.1, 59.9, 77.6, 115.4, 117.4, 137.6, 157.8, 166.9. Spectroscopic data were identical to those previously reported.¹⁶

To a stirred solution (-78 °C) of alcohol (95.0 mg, 0.558 mmol, 1.0 eq.) in CH₂Cl₂ (2 mL) was added 2,6-lutidine (112 μL, 0.949 mmol, 1.7 eq.) and TESOTf (164 μL, 0.725 mmol, 1.3 eq.). The mixture was stirred at -78 °C for 30 min. The cooling bath was removed and the reaction quenched with sat. aqueous NaHCO₃ (3 mL). The mixture was warmed to room temperature. CH₂Cl₂ (10 mL) were added. The organic layer was separated and the aqueous layer was extracted with CH₂Cl₂ (3 × 10 mL). The combined organics were dried over MgSO₄, filtered and evaporated *in vacuo*. Silica gel chromatography (hexanes / Et₂O 9:1) afforded the desired TES-ether (146 mg, 0.513 μmol, 92%) as a colorless oil.

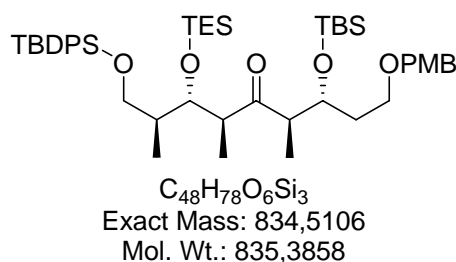
R_f = 0.45 (hexanes / Et₂O = 20:1); ¹H NMR (400 MHz, CDCl₃) δ = 0.51 (q, *J* = 8.0 Hz, 6H), 0.92 (t, *J* = 8.0 Hz, 9H), 1.27 (t, *J* = 7.1 Hz, 3H), 2.05 (s, 3H), 4.15 (q, *J* = 7.5 Hz, 2H), 4.47 (d, *J* = 5.6 Hz, 1H), 5.13 (dt, *J* = 10.2, 1.5 Hz, 1H), 5.29 (dt, *J* = 16.8, 1.5 Hz, 1H), 5.70 (m, 1H), 5.97 (s, 1H); ¹³C NMR (100 MHz, CDCl₃) δ = 4.8, 6.5, 6.8, 14.3, 14.8, 59.7, 78.1, 114.9, 115.8, 138.6, 159.0, 167.1.

¹⁶ Davalian, D.; Heathcock, C. H. *J. Org. Chem.* **1979**, *44*, 4458-4461.

(2*R*,3*S*,*E*)-((1*R*,2*S*)-2-(*N*-benzyl-2,4,6-trimethylphenylsulfonamido)-1-phenylpropyl) 5-iodo-2,4-dimethyl-3-(triethylsilyloxy)pent-4-enoate 256

To a solution of alcohol (92.0 mg, 136 μ mol, 1.0 eq.) in DCM (2.5 mL) was added pyridine (30 μ L, 350 μ mol, 2.5 eq.) and TESCOI (40 μ L, 210 μ mol, 1.5 eq.) at 0 °C. After stirring at room temperature for 18 h, the reaction mixture was quenched with sat. aqueous NaHCO₃ (3 mL). The organic layer was separated and the aqueous phase was extracted with DCM (3 \times 10 mL). Then the combined organic layer was dried over MgSO₄, filtered and the solvent was removed under reduced pressure, before the crude product was purified by flash chromatography on silica gel (hexanes / EtOAc = 9:1) to give the desired TES-ether (105 mg, 133 μ mol, 95%).

R_f = 0.57 (hexanes / EtOAc = 9:1); $[\alpha]_D^{20}$ = +27.6 (c = 0.88, CHCl₃); ¹H NMR (300 MHz, CDCl₃) δ = 0.50 (q, J = 8.0 Hz, 6H), 0.77 (d, J = 7.3 Hz, 3H), 0.86 (t, J = 8.0 Hz, 9H), 1.11 (d, J = 7.0 Hz, 3H), 1.77 (s, 3H), 2.31 (s, 3H), 2.43 (s, 6H), 2.64 (m, 1H), 4.00 (m, 1H), 4.35 (m, 2H), 4.91 (d, J = 16.0, 1H), 5.70 (d, J = 5.3 Hz, 1H), 6.21 (s, 1H), 6.68 (d, J = 7.0 Hz, 2H), 6.88 (s, 2H), 7.07 (m, 2H), 7.16, (m, 1H), 7.26 (m, 3H), 7.41 (m, 2H); ¹³C NMR (75 MHz, CDCl₃) δ = 4.6, 6.8, 14.0, 14.6, 18.6, 20.9, 22.9, 44.9, 48.3, 56.8, 77.8, 79.4, 80.7, 126.2, 127.4, 127.8, 128.2, 128.3, 128.4, 132.2, 133.1, 138.1, 138.8, 140.4, 142.4, 147.7, 173.1.

(5R,6R,8S,9S,10S)-5-(2-(4-methoxybenzyloxy)ethyl)-2,2,3,3,6,8,10,14,14-nonamethyl-13,13-diphenyl-9-(triethylsilyloxy)-4,12-dioxo-3,13-disilapentadecan-7-one 257

To a stirred solution (-78 °C) of alcohol (24.2 mg, 33.5 μ mol, 1.0 eq.) in CH_2Cl_2 (0.5 mL) was added 2,6-lutidine (6.7 μ L, 57 μ mol, 1.7 eq.) and TESOTf (9.8 μ L, 44 μ mol, 1.3 eq.). The mixture was stirred at -78 °C for 30 min. The cooling bath was removed and the reaction quenched with sat. aqueous $NaHCO_3$ (1 mL). The mixture was warmed to room temperature. CH_2Cl_2 (3 mL) were added. The organic layer was separated and the aqueous layer was extracted with CH_2Cl_2 (3 \times 3 mL). The combined organics were dried over $MgSO_4$, filtered and evaporated *in vacuo*. Silica gel chromatography (hexanes / Et_2O 9:1) afforded the desired TES-ether (26.0 mg, 31.1 μ mol, 93%) as a colorless oil.

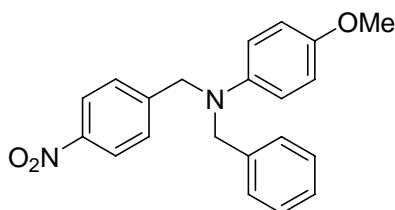
1H NMR (300 MHz, $CDCl_3$) δ = 0.006 (s, 3H), 0.01 (s, 3H), 0.51 (q, J = 7.7 Hz, 6H), 0.84 (s, 9H), 0.86 (t, J = 8.0 Hz, 9H), 0.93 (d, J = 6.4 Hz, 3H), 0.95 (d, J = 6.6 Hz, 3H), 1.05 (s, 9H), 1.09 (d, J = 7.2 Hz, 3H), 1.68 (m, 2H), 1.92 (m, 1H), 2.66 (m, 1H), 2.93 (m, 1H), 3.47 (m, 3H), 3.78 (dd, J = 10.2, 6.3 Hz, 1H), 3.78 (s, 3H), 3.94 (dd, J = 7.2, 3.8 Hz, 1H), 4.12 (m, 1H), 4.40 (s, 2H), 6.85 (d, J = 8.6 Hz, 2H), 7.23 (d, J = 8.1 Hz, 2H), 7.36 (m, 6H), 7.66 (m, 4H); ^{13}C NMR (75 MHz, $CDCl_3$) δ = -4.8, -4.5, 5.2, 6.5, 6.8, 7.0, 10.8, 13.6, 14.6, 18.1, 19.2, 25.9, 26.9, 33.0, 39.7, 48.2, 51.7, 55.3, 65.7, 67.0, 69.9, 72.4, 113.7, 127.6, 129.2, 129.6, 130.8, 133.9, 135.7, 159.1, 215.2.

8.6 Direct Reductive Amination

General procedure:

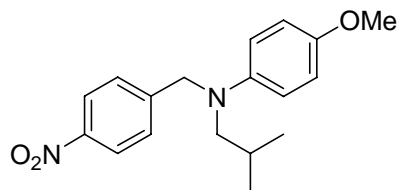
The amine (1.0 mmol), a first carbonyl (1.0 mmol), *Hantzsch* ester (1.5 mmol), and 5 Å molecular sieves were treated with catalytic amounts of thiourea (0.1 mmol) in toluene under argon atmosphere at 60 °C. After 24 h, a second carbonyl (1.0 mmol), *Hantzsch* ester (1.5 mmol) and thiourea (0.1 mmol) was added. The reaction mixture was stirred under argon atmosphere at 60 °C until complete conversion (24–72 h). After filtration over Celite, the solvent is evaporated and the residue purified by flash chromatography on silica gel using mixtures of petroleum ether and ethyl acetate as eluants to give the product amines in a pure form.

N-benzyl-4-methoxy-*N*-(4-nitrobenzyl)aniline **287-a**



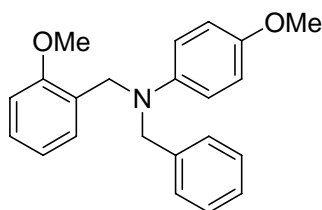
$C_{21}H_{20}N_2O_3$
Exact Mass: 348,1474
Mol. Wt.: 348,3951

$^1\text{H-NMR}$ (400 MHz, CDCl_3) δ = 8.13 (d, J = 12.0 Hz, 2 H), 7.43 (d, J = 12.0 Hz, 2 H), 7.24 (m, 5 H), 6.71 (m, 4 H), 4.55 (d, J = 12.0 Hz, 4 H), 3.72 (s, 3 H); ^{13}C (100 MHz, CDCl_3) δ = 152.29, 147.17, 143.19, 138.34, 128.68, 127.19, 123.84, 115.47, 114.91, 56.08, 55.70, 54.98.

***N*-isobutyl-4-methoxy-*N*-(4-nitrobenzyl)aniline 287-b**

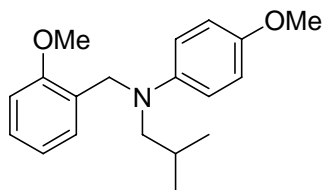
$C_{18}H_{22}N_2O_3$
Exact Mass: 314,163
Mol. Wt.: 314,3789

1H -NMR (400 MHz, $CDCl_3$) δ = 8.11 (d, J = 12, 2 H), 7.25 (d, J = 56, 2 H) 6.64 (dd, J = 12 Hz, 52 Hz, 4 H), 4.55 (s, 2 H), 3.72 (s, 3 H), 3.12 (d, J = 8 Hz, 2 H), 2.04 (m, 1 H), 0.93 (d, J = 8 Hz, 6 H); ^{13}C (100 MHz, $CDCl_3$) δ = 152.16, 147.55, 147.06, 142.97, 127.70, 123.76, 115.42, 114.85, 61.17, 56.42, 55.72, 27.45, 20.57.

***N*-benzyl-4-methoxy-*N*-(2-methoxybenzyl)aniline 287-c**

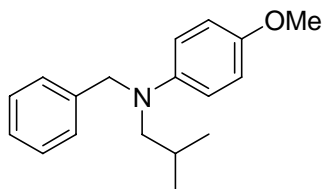
$C_{22}H_{23}NO_2$
Exact Mass: 333,1729
Mol. Wt.: 333,4235

1H -NMR (400 MHz, $CDCl_3$), δ = 6.62 (m, 13 H), 4.58 (d, J = 8 Hz, 4 H), 3.71 (d, J = 40 Hz, 6 H); ^{13}C (100 MHz, $CDCl_3$) δ 157.38, 151.38, 143.86, 139.40, 128.57, 126.74, 126.59, 120.47, 114.85, 113.62, 110.07, 55.81, 55.17, 50.35.

***N*-isobutyl-4-methoxy-*N*-(2-methoxybenzyl)aniline 287-d**

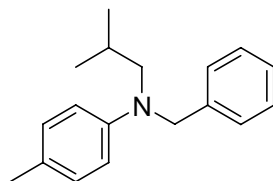
$C_{19}H_{25}NO_2$
Exact Mass: 299,1885
Mol. Wt.: 299,4073

1H -NMR (400 MHz, $CDCl_3$) δ = 6.57 (m, 8 H), 4.50 (s, 2 H), 3.86 (s, 3 H), 3.71 (d, J = 4 Hz, 3 H), 3.15 (d, J = 8 Hz, 2 H), 2.10 (m, 1 H), 0.85 (m, 6 H); ^{13}C (100 MHz, $CDCl_3$) δ = 157.28, 150.89, 143.77, 127.58, 127.39, 126.72, 120.34, 114.81, 113.52, 109.93, 60.35, 55.84, 55.20, 50.86, 27.60, 20.59.

***N*-benzyl-*N*-isobutyl-4-methoxyaniline 287-e**

$C_{18}H_{23}NO$
Exact Mass: 269,178
Mol. Wt.: 269,3813

1H -NMR (300 MHz, $CDCl_3$) δ = 7.25 (m, 5 H), 6.67 (dd, J = 6 Hz, 9 Hz, 33 Hz, 4 H), 4.49 (s, 2 H), 3.72 (s, 3 H), 3.11 (d, J = 6 Hz, 2 H), 2.07 (m, 1 H), 0.93 (d, J = 6 Hz, 6 H), ^{13}C (300 MHz, $CDCl_3$) δ 151.35, 143.72, 139.32, 128.42, 126.59, 114.71, 60.43, 56.40, 55.75, 27.38, 20.59.

***N*-benzyl-*N*-isobutyl-4-methylaniline 289-f**

$C_{18}H_{23}N$
Exact Mass: 253,183
Mol. Wt.: 253,3819

1H -NMR (400 MHz, $CDCl_3$) δ = 7.21 (m, 5 H), 6.98 (d, J = 12 Hz, 2 H), 4.57 (s, 2 H), 3.20 (d, J = 4 Hz, 2 H), 2.23 (s, 3 H), 2.14 (m, 1 H), 0.95 (d, J = 8 Hz, 6 H); ^{13}C (100 MHz, $CDCl_3$) δ 146.84, 139.22, 129.65, 128.50, 126.71, 126.60, 125.17, 112.83, 59.86, 55.61, 29.75, 27.43, 20.58, 20.18.

References and Notes

- ¹ (a) Newman, D. J. Cragg, G. M. *J. Nat. Prod.* **2007**, *70*, 461-477. (b) Newman, D. J.; Cragg, G. M.; Snader, K. M. *Nat. Prod. Rep.* **2000**, *17*, 215-234.
- ² Ōmura, S.; Sunazuka, T. *Chem. Rev.* **2005**, *105*, 4559-4580.
- ³ Gerth, K.; Pradella, S.; Perlova, O.; Beyer, S.; Müller, R. *J. Biotechnol.* **2003**, *106*, 233.
- ⁴ (a) Reichenbach, H. *J. Industr. Microbiol. Biotechn.* **2001**, *27*, 149-156. (b) Reichenbach H.; Höfle, G., *Myxobacteria as Producers of Secondary Metabolites*, Springer, Berlin, **1999**, pp. 149-179. (c) Höfle, G.; Reichenbach, H., in: *Sekundärmetabolismus bei Mikroorganismen* (Eds. W. Kuhn, H. P. Fiedler) Attempto Verlag, Tübingen, **1995**, pp. 61-78. (d) Reichenbach, H.; Höfle, G. *Biotech. Adv.* **1993**, *11*, 219-277. (e) Menche, D. *Nat. Prod. Rep.* **2008**, in press.
- ⁵ Wenzel, S. C.; Müller, R. *Nat. Prod. Rep.* **2007**, *24*, 1211-1224.
- ⁶ Höfle, G.; Bedorf, N.; Steinmetz, H.; Schomburg, D.; Gerth, K.; Reichenbach, H. *Angew. Chem. Int. Ed.* **1996**, *35*, 1567.
- ⁷ (a) Cortes, J.; Baselga, J. *Oncologist* **2007**, *12*, 271-280. (b) Lee, F. Y. *Clin. Cancer Res.* **2001**, *7*, 1429-1437.
- ⁸ Reichenbach, H.; Höfle, G., in: *Drug Discovery from Nature* (Eds. S. Grabley, R. Thierecke) Springer Verlag, Berlin, **1999**, pp. 149-179.
- ⁹ Höfle, G.; Reichenbach, H.; Sasse, F.; Steinmetz, H., German Patent DE 41 42 951 C1, **1993**.
- ¹⁰ Sasse, F.; Steinmetz, H.; Höfle, G.; Reichenbach, H. *J. Antibiot.* **2003**, *56*, 520.
- ¹¹ Huss, M.; Sasse, F.; Kunze, B.; Jansen, R.; Steinmetz, H.; Ingenhorst, G.; Zeeck, A.; Wiczorek, H. *BMC Biochem* **2005**, *6*, 13.
- ¹² Bowman, E. J.; Gustafson, K. R.; Bowman, B. J.; Boyd, M. R. *J. Biol. Chem.* **2003**, *278*, 44147-44152.
- ¹³ (a) Muroi, M.; Shiragami, N.; Nagao, K.; Yamasaki, M.; Takatsuki, A. *Cell Struct. Funct.* **1993**, *18*, 139. (b) Drose, S.; Bindseil, K. U.; Bowman, E. J.; Siebers, A.; Zeeck, A.; Altendork, K. *Biochemistry* **1993**, *32*, 3902.
- ¹⁴ Diyabalanage, T.; Amsler, C. D.; McClintock, J. B.; Baker, B. J. *J. Am. Chem. Soc.* **2006**, *128*, 5630-5631.
- ¹⁵ Kazami, S.; Muroi, M.; Kawatani, M.; Kubota, T.; Usui, T.; Kobayashi, J.; Osada, H. *Biosci. Biotechnol. Biochem.* **2006**, *70*, 1364-1370.
- ¹⁶ Beyenbach, K. W.; Wiczorek, H. *J. Exp. Biol.* **2006**, *209*, 577.

-
- ¹⁷ Hassfeld, J.; Fare's, C.; Steinmetz, H.; Carlomagno, T.; Menche, D. *Org. Lett.* **2006**, *8*, 4751-4754.
- ¹⁸ Höfle, G.; Reichenbach, H.; Irschik, H.; Schummer, D., German Patent DE 196 30 980 A1: 1-7, **1998**.
- ¹⁹ Irschik, H.; Schummer, D.; Höfle, G.; Reichenbach, H.; Steinmetz, H.; Jansen, R. *J. Nat. Prod.* **2007**, *70*, 1060-1063.
- ²⁰ Alberts, B., et al. (2002). *Molecular biology of the cell*. 4th edition. Garland Science, New York. 302-335. "From DNA to RNA"
- ²¹ Jin, D. J.; Zhou, Y. N. *Methods Enzymol.* **1996**, *273*, 300-319.
- ²² Irschik, H.; Jansen, R.; Höfle, G.; Gerth, K.; Reichenbach, H. *J. Antibiot.* **1985**, *38*, 145-152.
- ²³ Irschik, H.; Augustiniak, H.; Gerth, K.; Höfle, G.; Reichenbach, H. *J. Antibiot.* **1995**, *48*, 787-792.
- ²⁴ Irschik, H.; Jansen, R.; Gerth, K.; Höfle, G.; Reichenbach, H. *J. Antibiot.* **1987**, *40*, 7-13.
- ²⁵ Parenti, F.; Lancini, G. in *Antibiotic and Chemotherapy*; O'Grady, F.; Lambert, H. P.; Finch, R. G.; Greenwood, D., Eds.; Churchill Livingstone: New York, **1997**; pp. 453-459.
- ²⁶ Menche, D.; Arikian, F.; Perlova, O.; Horstmann, N.; Ahlbrecht, W.; Wenzel, S. C.; Jansen, R.; Irschik, H.; Müller, R. *J. Am. Chem. Soc.* **2008**, *130*, 14234-14243.
- ²⁷ O'Hagan, D. *The Polyketide Metabolites*, Ellis Horwood, Chichester, U.K. **1991**.
- ²⁸ Moore, B. S.; Hertweck, C. *Nat. Prod. Rep.* **2002**, *19*, 70-99.
- ²⁹ Hopwood, D. A. *Chem. Rev.* **1997**, *97*, 2465-2497.
- ³⁰ Katz, L. *Chem. Rev.* **1997**, *97*, 2557-2575.
- ³¹ Zimmerman, H.E.; Traxler, M. D. *J. Am. Chem. Soc.* **1957**, *79*, 1920-1923.
- ³² (a) Evans, D. A.; Bartroli, J.; Shih, T. L. *J. Am. Chem. Soc.* **1981**, *103*, 2127-2129. (b) Evans, D. A. *Aldrichimica Acta* **1982**, *15*, 23.
- ³³ Evans, D. A.; Takacs, J. M.; McGee, L. R.; Ennis, M. D.; Bartroli, D. J. *J. Pure & Appl. Chem.* **1981**, *53*, 1109-1127.
- ³⁴ Walker, M. A.; Heathcock, C. H. *J. Org. Chem.* **1991**, *56*, 5747-5750.
- ³⁵ Crimmins, M. T.; King, B. W.; Tabet, E. A.; Chaudhary, K. *J. Org. Chem.* **2001**, *66*, 894.
- ³⁶ Evans, D. A.; Tedrow, J. S.; Shaw, J. T.; Downey, C. W. *J. Am. Chem. Soc.* **2002**, *124*, 392.
- ³⁷ Evans, D. A.; Downey, C. W.; Shaw, J. T.; Tedrow, J. S. *Org. Lett.* **2002**, *4*, 1127-1130.
- ³⁸ Abiko, A.; Liu, J.-F.; Masamune, S. *J. Am. Chem. Soc.* **1997**, *119*, 2586-2587.
- ³⁹ Liu, J.-F.; Abiko, A.; Pei, Z.; Buske, D. C.; Masamune, S. *Tetrahedron Lett.* **1998**, *39*, 1873.
- ⁴⁰ Fanjul, A.; Hulme, A. N.; White, J. W. *Org. Lett.* **2006**, *8*, 4219-4222.

-
- ⁴¹ (a) Paterson, I.; Wallace, D. J.; Velázquez, S. M. *Tetrahedron Lett.* **1994**, *35*, 9083-9086. (b) Paterson, I.; Wallace, D. J. *Tetrahedron Lett.* **1994**, *35*, 9477-9487.
- ⁴² Paterson, I.; Wallace, D. J.; Cowden, C. J. *Synthesis* **1998**, 639-652.
- ⁴³ (a) Paterson, I.; Wallace, D. J. *Tetrahedron Lett.* **1994**, *35*, 9087-9090. (b) Paterson, I.; Wallace, D. J.; Velázquez, S. M. *Tetrahedron Lett.* **1994**, *35*, 9083-9086.
- ⁴⁴ (a) Paterson, I.; Norcross, R. D.; Ward, R. A.; Romea, P.; Lister, M. A. *J. Am. Chem. Soc.* **1994**, *116*, 11287-11314. (b) Paterson, I.; Tillyer, R. D. *Tetrahedron Lett.* **1992**, *33*, 4233-4236. (c) Paterson, I.; Perkins, *Tetrahedron Lett.* **1992**, *33*, 801-804. (d) Paterson, I.; Goodman, J. M.; Isaka, M. *Tetrahedron Lett.* **1989**, *30*, 7121-7124.
- ⁴⁵ (a) Paterson, I.; Arnott, E. A. *Tetrahedron Lett.* **1998**, *39*, 7185-7188. (b) Paterson, I.; Florence, G. J.; Gerlach, K.; Scott, J. P.; Sereinig, N. *J. Am. Chem. Soc.* **2001**, *123*, 9535-9544.
- ⁴⁶ (a) Oppolzer, W.; Blagg, J.; Rodriguez, I.; Walther, E. *J. Am. Chem. Soc.* **1990**, *112*, 2767-2772. (b) Oppolzer, W.; Starkemann, C.; Rodriguez, I.; Bernardinelli, G. *Tetrahedron Lett.* **1991**, *32*, 61-64. (c) Oppolzer, W.; Lienard, P. *Tetrahedron Lett.* **1993**, *34*, 4321-4324.
- ⁴⁷ Oppolzer, W.; Brabander, J. D.; Walther, E.; Bernardinelli, G. *Tetrahedron Lett.* **1995**, *36*, 4413-4416.
- ⁴⁸ Wang, Y-Ch.; Hung, A-W.; Chang, Ch-Sh.; Yan, T-H. *J. Org. Chem.* **1996**, *61*, 2038-2043.
- ⁴⁹ (a) Myers, A. G.; Widdowson, K. L. *J. Am. Chem. Soc.* **1990**, *112*, 9672-9674. (b) Myers, A. G.; Widdowson, K. L.; Kukkola, P. J. *J. Am. Chem. Soc.* **1992**, *114*, 2765-2767.
- ⁵⁰ (a) Ghosh, A. K.; Onishi, M. *J. Am. Chem. Soc.* **1996**, *118*, 2527-2528. (b) Ghosh, A. K.; Fidanze, S.; Onishi, M.; Hussain, K. H. *Tetrahedron Lett.* **1997**, *38*, 7171-7174. (c) Ghosh, A. K.; Liu, C. *J. Am. Chem. Soc.* **2003**, *125*, 2374-2375.
- ⁵¹ (a) Helmchen, G., Hoffmann, R., Mulzer, J., Schaumann, E., Eds. In *Stereoselective Synthesis, Methods of Organic Chemistry (Houben-Weyl)*, 21st ed.; Thieme Stuttgart: New York, **1996**; Vol.3, pp 1357-1602. (b) Chemler, S. R.; Roush, W. R. In *Modern Carbonyl Chemistry*; Otera, J., Ed.; Wiley-VCH: Weinheim, **2000**; Chapter 11. (c) Denmark, S. E.; Almstead, N. G. In *Modern Carbonyl Chemistry*; Otera, J., Ed.; Wiley-VCH: Weinheim, **2000**; Chapter 10.
- ⁵² Denmark, S. E.; Weber, E. J. *Helv. Chim. Acta.* **1983**, *66*, 1655-1660.
- ⁵³ Denmark, S. E.; Fu, J. *Chem. Rev.* **2003**, *103*, 2763-2793
- ⁵⁴ (a) Nishida, M.; Tozawa, T.; Yamada, K.; Mukaiyama, T. *Chem. Lett.* **1996**, 1125. (b) Yamada, K.; Tozawa, T.; Nishida, M.; Mukaiyama, T. *Bull. Chem. Soc. Jpn.* **1997**, *70*, 2301.
- ⁵⁵ Masse, C. E.; Panek, J. C. *Chem. Rev.* **1995**, *95*, 1293-1316.

- ⁵⁶ (a) Jacobsen, E. N. et al. Ed.; *Comprehensive Asymmetric Catalysis*; Springer: Berlin, **1999**; p. 965-82. (b) Lin, Guo-Qiang et al. Ed.; *Principles and Applications of Asymmetric Synthesis*; John Wiley & Sons, Inc., **2001**; p. 167-178.
- ⁵⁷ (a) Hoffmann, R. W. In *Stereocontrolled Organic Synthesis*; Trost, B. M., Ed.; Blackwell Scientific Publications: Cambridge; **1994**; pp 259-274. (b) Roush, W. R. In *Stereoselective Synthesis, Methods of Organic Chemistry (Houben-Weyl)*, 21st ed.; Helmchen, G., Hoffmann, R. W., Mulzer, J., Schaumann, E., Eds.; Thieme Stuttgart: New York, **1996**; Vol. 3, pp 1410-1486.
- ⁵⁸ (a) Brown, H. C.; Bhat, K. S. *J. Am. Chem. Soc.* **1986**, *108*, 293-294. (b) Brown, H. C.; Bhat, K. S. *J. Am. Chem. Soc.* **1986**, *108*, 5919-5923. (c) Roush, W. R. In *Comprehensive Organic Synthesis*, Trost, B. M.; Fleming, I., Eds., Pergamon Press: New York, **1991**, Vol. 2, pp. 1-53.
- ⁵⁹ Li, Y.; Houk, K. N. *J. Am. Chem. Soc.* **1989**, *111*, 1236-1240.
- ⁶⁰ Brown, H. C.; Racherla, U. S.; Pellechia, P. J. *J. Org. Chem.*; **1990**; *55*(6); 1868-1874.
- ⁶¹ (a) Herold, T.; Hoffmann, R. W. *Angew. Chem., Int. Ed. Engl.* **1978**, *17*, 768-769. (b) Hoffmann, R. W.; Helbig, W. *Chem. Ber.* **1981**, *114*, 2802-2807. (c) Lachance, H.; Lu, X.; Gravel, M.; Hall, D. G. *J. Am. Chem. Soc.* **2003**, *125*, 10160-10161.
- ⁶² (a) Roush, W. R. In *Comprehensive Organic Synthesis*, Trost, B. M.; Fleming, I., Eds., Pergamon Press: New York, **1991**, Vol. 2, pp. 1-53. (b) Roush, W. R.; Ando, K.; Powers, D. B.; Palkowitz, A. D.; Halterman, R. L. *J. Am. Chem. Soc.* **1990**, *112*, 6339-6348. (c) Roush, W. R.; Palkowitz, A. D.; Ando, K. *J. Am. Chem. Soc.* **1990**, *112*, 6348-6359. (d) Roush, W. R.; Palkowitz, A. D.; Palmer, M. A. *J. Org. Chem.* **1987**, *52*, 316-318. (e) Roush, W. R.; Halterman, R. L. *J. Am. Chem. Soc.* **1986**, *108*, 294-296. (f) Roush, W. R.; Walts, A. E.; Hoong, L. K. *J. Am. Chem. Soc.* **1985**, *107*, 8186-8190.
- ⁶³ Garcia, J.; Kim, B.; Masamune, S. *J. Org. Chem.* **1987**, *52*, 4831.
- ⁶⁴ Corey, E. J.; Yu, C.-M.; Kim, S. S. *J. Am. Chem. Soc.* **1989**, *111*, 5495.
- ⁶⁵ Burgos, C. H.; Canales, E.; Matos, K.; Soderquist, J. A. *J. Am. Chem. Soc.* **2005**, *127*, 8044.
- ⁶⁶ Peng, F.; Hall, D. G. *J. Am. Chem. Soc.* **2007**, *129*, 3070-3071.
- ⁶⁷ Duthaler, R. O.; Hafner, A.; Riediker, M. *Pure & Appl. Chem.* **1990**, *62*, 631-642.
- ⁶⁸ (a) Hafner, A.; Duthaler, R. O.; Marti, R.; Rihs, G.; Rothe-Streit, P.; Schwarzenbach, F. *J. Am. Chem. Soc.* **1992**, *114*, 2321-2336. (b) Duthaler, R. O.; Hafner, A.; *Chem. Rev.* **1992**, *92*, 807832.
- ⁶⁹ Hackman, B. M.; Lombardi, P. J.; Leighton, J. L. *Org. Lett.* **2004**, *6*, 4375-4377.

-
- ⁷⁰ Marshall, J. A.; Adams, N. D. *J. Org. Chem.* **1999**, *64*, 5201.
- ⁷¹ Marshall, J. A.; Grant, C. M. *J. Org. Chem.* **1999**, *64*, 8214.
- ⁷² (a) Marshall, J. A. *Chem. Rev.* **1996**, *96*, 31. (b) Marshall, J. A. *Chem. Rev.* **2000**, *100*, 3163.
- ⁷³ Marshall, J. A.; Chobanian, H. R.; Yanik, M. M. *Org. Lett.* **2001**, *3*, 3369.
- ⁷⁴ (a) Jung, M. E.; D'Amico, D. C. *J. Am. Chem. Soc.* **1993**, *115*, 12208 and references therein. (b) Jung, M. E.; D'Amico, D. C. *J. Am. Chem. Soc.* **1995**, *117*, 7379. (c) Jung, M. E.; D'Amico, D. C. *J. Am. Chem. Soc.* **1997**, *119*, 12150. (d) Jung, M. E.; Lee, W. S.; Sun, D. *Org. Lett.* **1999**, *1*, 307. (e) Jung, M. E.; Sun, D. *Tetrahedron Lett.* **1999**, *40*, 8343.
- ⁷⁵ Jung, M. E.; Marquez, R. *Org. Lett.* **2000**, *2*, 1669-1672.
- ⁷⁶ (a) Nakai, T.; Mikami, K. *Chem. Rev.* **1986**, *86*, 885-902. (b) Marshall, J. A. In *Comprehensive Organic Synthesis*, Trost, B. M.; Fleming, I., Eds., Pergamon Press: London, **1991**, Vol. 3. (c) Mikami, K.; Nakai, T. *Synthesis* **1991**, 594-604.
- ⁷⁷ Tsai, D. J.-S.; Midland, M. M. *J. Org. Chem.* **1984**, *49*, 1842-1843.
- ⁷⁸ Tsai, D. J.-S.; Midland, M. M. *J. Am. Chem. Soc.* **1985**, *107*, 3915-3918.
- ⁷⁹ Parker, K. A.; Cao, H. *Org. Lett.* **2006**, *8*, 3541-3544.
- ⁸⁰ Whitehead, A.; McParland, J. P.; Hanson, P. R. *Org. Lett.* **2006**, *8*, 5025-5028.
- ⁸¹ Corey, E. J.; Boaz, N. W. *Tetrahedron Lett.* **1984**, *25*, 3063-3066.
- ⁸² N. A. Rai, A. Basu, *Tetrahedron Lett.* **2003**, *44*, 2267.
- ⁸³ Compound **64** was prepared by Jun Li.
- ⁸⁴ C. J. Cowden, I. Paterson, *Org. React.* **1997**, *51*, 1.
- ⁸⁵ W. C. Still, C. Gennari, *Tetrahedron Lett.* **1983**, *24*, 4405.
- ⁸⁶ P. Nigel, G. David, *Tetrahedron Lett.* **1999**, *40*, 3811.
- ⁸⁷ (a) I. Thomson, K. Clausen, S. Schelbye, S. O. Lawesson, *Org. Synth.* **1984**, *62*, 158. (b) B. Yde, N. M. Yousif, U. Pedersen, I. Thomsen, S. O. Lawesson, *Tetrahedron* **1984**, *40*, 11, 2047.
- ⁸⁸ For previous examples on related cyclisations, see: (a) M. W. Bredenkamp, C. W. Holzapfel, W. J. van Zyl, *Synthetic Commun.* **1990**, *20*, 2235. (b) M. A. Ciufolini, Y. C. Shen, *J. Org. Chem.* **1997**, *62*, 3804. (c) J.-C. Jung, R. Kache, K. K. Vines, Y.-S. Zheng, P. Bijoy, M. Valluri, M. A. Avery, *J. Org. Chem.* **2004**, *26*, 9269.
- ⁸⁹ von Geldern, T. W.; Hoffman, D. J.; Kester, J. A.; Nellans, H. N.; Dayton, B. D.; Calzadilla, S. V.; Marsh, K. C.; Hernandez, L.; Chiou, W.; Dixon, D. B.; Wu-Wong, J. R.; Opgenorth, T. *J. J. Med. Chem.* **1996**, *39*, 4, 982.

-
- ⁹⁰ (a) H. C. Brown, K. S. Bath, *J. Am. Chem. Soc.* **1986**, *108*, 5919. (b) H. C. Brown, K. S. Bhat, R. S. Randad, *J. Org. Chem.* **1989**, *54*, 1570.
- ⁹¹ Gaul, C.; Njardarson, J. T.; Danishefsky, S. J. *J. Am. Chem. Soc.* **2003**, *125*, 6042-6043.
- ⁹² (a) Negishi, E.; van Horn, D. E.; King, A. O.; Okukado, N. *Synthesis* **1979**, 501-502; (b) Rand, C. L.; van Horn, D. E.; Moore, M. W.; Negishi, E. *J. Org. Chem.* **1981**, *46*, 4093-4096. (c) Baker, R.; Cummings, W. J.; Hayes, J. F.; Kumar, A. *J. Chem. Soc., Chem. Commun.* **1986**, 1237-1239.
- ⁹³ Layton, M. E.; Morales, C. A.; Shair, M. D. *J. Am. Chem. Soc.* **2002**, *124*, 773-775.
- ⁹⁴ (a) Matsumura, K.; Hashiguchi, S.; Ikariya, T.; Noyori, R. *J. Am. Chem. Soc.* **1997**, *119*, 8738; (b) Marshall, J. A.; Bourbeau, M. P. *Org. Lett.* **2003**, *5*, 3197-3199.
- ⁹⁵ Mori, K.; Koseki, K. *Tetrahedron* **1988**, *44*, 6013-6020.
- ⁹⁶ Smith III, A. B.; Condon, S. M.; McCauley, J. A.; Leahy, J. W.; Leazer, Jr., J. L.; Maleczka, Jr., R. E. *Tetrahedron Lett.* **1994**, *35*, 4907-4910.
- ⁹⁷ (a) Nahm, S.; Weinreb, S. M. *Tetrahedron Lett.* **1981**, *22*, 3815-3818. (b) Trost, B. M.; Gunzner, J. L. *J. Am. Chem. Soc.* **2001**, *123*, 9449-9450.
- ⁹⁸ Alemany, C.; Bach, J.; Garcia, J.; López, M.; Rodríguez, A. B. *Tetrahedron* **2000**, *56*, 9305-9312.
- ⁹⁹ Baker, R.; Castro, J. L. *J. Chem. Soc. Perkin Trans. 1* **1990**, 47-65.
- ¹⁰⁰ Fatiadi, A. J. *Synthesis* **1976**, 65-104.
- ¹⁰¹ Inoue, T.; Liu, J.-F.; Buske, D. C.; Abiko, A. *J. Org. Chem.* **2002**, *67*, 5250-5256.
- ¹⁰² Evans, D. A.; Ratz, A. M.; Huff, B. E.; Sheppard, G. S. *J. Am. Chem. Soc.* **1995**, *117*, 3448-3467.
- ¹⁰³ Walba, D. M.; Thurmes, W. N.; Haltiwanger, R. C. *J. Org. Chem.* **1988**, *53*, 1046-1056.
- ¹⁰⁴ Trost, B. M.; Gunzner, J. L.; Dirat, O.; Rhee, Y. H. *J. Am. Chem. Soc.* **2002**, *124*, 10396-10415.
- ¹⁰⁵ (a) Frigerio, M.; Santagostino, M.; Sputore, S. *J. Org. Chem.* **1999**, *64*, 4537-4538. (b) Ireland, R. E.; Liu, L. *J. Org. Chem.* **1993**, *58*, 2899-2899.
- ¹⁰⁶ Maryanoff, B. E.; Reitz, A. B. *Chem. Rev.* **1989**, *89*, 863-927.
- ¹⁰⁷ (a) Ren, H.; Krasovskiy, A.; Knochel, P. *Org. Lett.* **2004**, *5*, 4215-4217. (b) Knochel, P.; Dohle, W.; Gommermann, N.; Kneisel, F. F.; Kopp, F.; Korn, T.; Sapountzis, I.; Vu, V. A. *Angew. Chem.* **2003**, *115*, 4438-4456.
- ¹⁰⁸ (a) Stürmer, R.; Ritter, K.; Hoffmann, R. W. *Angew. Chem.* **1993**, *105*, 112-114. (b) Marshall, J. A.; Andrews, R. C. *J. Org. Chem.* **1985**, *50*, 1602-1606.

-
- ¹⁰⁹ (a) Williams, J. M.; Jobson, R. B.; Yasuda, N.; Marchesini, G.; Dolling, U.-H.; Grabowski, E. J.J. *Tetrahedron Lett.* **1995**, *36*, 5461-5464. (b) Evano, G.; Schaus, J. V.; Panek, J. S. *Org. Lett.*; 2004, *6*, 525-528.
- ¹¹⁰ K. Nützel, H. Gilman, G. F. Wright, *Methoden Org. Chem. (Houben-Weyl)* **1973**, Vol. 13/2a, p. 49-527.
- ¹¹¹ Basha, A.; Lipton, M.; Weinreb, S. M. *Tetrahedron Lett.* **1977**, *18*, 4171-4174.
- ¹¹² Shimizu, T.; Osako, K.; Nakata, T. *Tetrahedron Lett.* **1997**, *38*, 2685-2688.
- ¹¹³ Huang, P.-Q.; Zheng, X.; Deng, X.-M. *Tetrahedron Lett.* **2001**, *42*, 9039-9041.
- ¹¹⁴ Calter, M. A.; Bi, F. C. *Org. Lett.* **2000**, *2*, 1529-1531.
- ¹¹⁵ Blanchette, M. A.; Choy, W.; Davis, J. T.; Essenfeld, A. P.; Masamune, S.; Roush, W. R.; Sakai, T. *Tetrahedron Lett.* **1984**, *25*, 2183-2186.
- ¹¹⁶ Prepared by Sven Rudolph: Sven Rudolph, Dissertation, Universität Hannover, **2008**.
- ¹¹⁷ (a) R. F. Heck, J. P. Nolley, *J. Org. Chem.* **1972**, *37*, 14, 2320. (b) R. F. Heck, H. A. Dieck, *J. Am. Chem. Soc.* **1974**, *96*, 1133. (c) R. F. Heck, *Org React.* **1982**, *27*, 345-390. (d) T. Jeffrey, *Chem Comm.* **1984**, 1287-1289. (e) T. Jeffrey, *Tetrahedron Lett.* **1985**, *26*, 2667-2670. (g) T. Jeffrey, *Synthesis* **1987**, 70.
- ¹¹⁸ Prepared by Sven Rudolph: Sven Rudolph, Dissertation, Universität Hannover, **2008**.
- ¹¹⁹ Ziegler, F. E.; Chakraborty, U. R.; Weisenfeld, R. B. *Tetrahedron* **1981**, *37*, 4035-4040.
- ¹²⁰ LC-MS analysis and calculated for C₄₇H₇₃N₂O₇SSi [M+H]⁺, 837.5, found: 837.3.
- ¹²¹ Menche, D.; Hassfeld, J.; Li, J.; Rudolph, S. *J. Am. Chem. Soc.* **2007**, *129*, 6100-6101.
- ¹²² (a) Arikan, F.; Li, J.; Menche, D. *Org. Lett.* **2008**, *10*, 3521-3524. (b) Oishi, Nakata, T. *Acc. Chem. Res.* **1984**, *17*, 338.
- ¹²³ (a) Paterson, I.; Wallace, D. J.; *Tetrahedron* **1996**, *52*, 1811. (b) Paterson, I.; Wallace, D. J.; *Tetrahedron Lett.* **1992**, *33*, 801.
- ¹²⁴ (a) Hartung, J.; Honig, S.; Kneuer, R.; Schwarz, M.; Wenner, H. *Synthesis* **1997**, 1433-1438. (b) Yoshida, Y.; Sakakura, Y.; Aso, N.; Okada, S.; Tanabe, Y. *Tetrahedron* **1999**, *55*, 2183-2192.
- ¹²⁵ (a) Bal, B. S.; Childers, W. E.; Pinnick, H. W. *Tetrahedron* **1981**, *37*, 2091. (b) Kraus, G. A.; Roth, B. *J. Org. Chem.* **1980**, *45*, 4825-4830. (c) Corey, E. J.; Myers, A. G. *J. Am. Chem. Soc.* **1985**, *107*, 5574-5576.
- ¹²⁶ Kubota, K.; Leighton, J. L. *Angew. Chem., Int. Ed.* **2003**, *42*, 946-948.
- ¹²⁷ (a) Kuczkowski, R. L. *Chem. Soc. Rev.* **1992**, *21*, 79-83. (b) Sander, W. *Angew. Chem. Int. Ed.* **1990**, *29*, 344. (c) Horie, O.; Moorgat, G. K. *Acc. Chem. Res.* **1998**, *31*, 387-396.

- ¹²⁸ Stork, G.; Zhao, K. *Tetrahedron Lett.* **1989**, *30*, 2173-2174.
- ¹²⁹ (a) Parikh, J. R.; Doering, W. von E. *J. Am. Chem. Soc.* **1967**, *89*, 5505-5507. (b) Evans, D. A.; Ripin, D. H.; Halstead, D. P.; Campos, K. R. *J. Am. Chem. Soc.* **1999**, *121*, 6816-6826.
- ¹³⁰ (a) Paterson, I.; Gibson, K. R.; Oballa, R. M. *Tetrahedron Lett.* **1996**, *37*, 8585-8588. (b) Paterson, I.; Collett, L. A. *Tetrahedron Lett.* **2001**, *42*, 1187-1191. (c) Evans, D. A.; Côté, B.; Coleman, P. J.; Connell, B. T. *J. Am. Chem. Soc.* **2003**, *125*, 10893-10898.
- ¹³¹ Famer, L. J.; Marron, K. S.; Koch, S. S. C.; Hwang, C.K.; Kallel, E. A.; Zhi, L.; Nadzan, A. M.; Robertson, D. W.; Bennani, Y. L. *Bioorg. Med. Chem. Lett.* **2006**, *16*, 2352-2356.
- ¹³² de Lera, A. R.; Iglesias, B.; Rodriguez, J.; Alvarez, R.; Lopez, S.; Villanueva, X.; Padros, E. *J. Am. Chem. Soc.* **1995**, *117*, 8220-8231.
- ¹³³ (a) Mohr, P. J.; Halcomb, R. L. *Org. Lett.* **2002**, *4*, 2413-2416. (b) Kim, H.; Choi, W. J.; Jung, J.; Kim, S.; Kim, D. *J. Am. Chem. Soc.* **2003**, *125*, 10238-10240.
- ¹³⁴ N. Nakajima, M. Saito, M. Ubukata, *Tetrahedron Lett.* **1988**, *29*, 5565-5568.
- ¹³⁵ Paterson, I.; Ashton, K.; Britton, R.; Cecere, G.; Chouraqui, G.; Florence, G. J.; Stafford, J. *Angew. Chem.* **2007**, *119*, 6279-6283.
- ¹³⁶ (a) PPTS: Roush, W. R.; Marron, T. G.; Pfeifer, L. A. *J. Org. Chem.* **1997**, *62*, 474-478. (b) CSA: Dahan, A.; Portnoy, M. *J. Org. Chem.* **2001**, *66*, 6480-6482. (c) BF₃·Et₂O: Wang, C.; Forsyth, C. J. *Org. Lett.* **2006**, *8*, 2997-3000. (d) Sc(OTf)₃: Paterson, I.; Anderson, E. A.; Dalby, A., S. M. *Synthesis* **2005**, 3225-3228.
- ¹³⁷ Park, P. K.; O'Malley, S. J.; Schmidt, D. R.; Leighton, J. L. *J. Am. Chem. Soc.* **2006**, *128*, 2796-2797.
- ¹³⁸ Ahmed, M.; Atkinson, C. E.; Barrett, A. G. M.; Malagu, K.; Procopiou, P. A. *Org. Lett.* **2003**, *5*, 669-672.
- ¹³⁹ Seco, J. M.; Quinoa, E.; Riguera, R. *Chem. Rev.* **2004**, *104*, 17-118.
- ¹⁴⁰ Paton, R. S.; Goodman, J. M. *Org. Lett.* **2006**, *8*, 4299-4302.
- ¹⁴¹ Paterson, I.; Wallace, D. J.; Cowden, C. J. *Synthesis* **1998**, 639-652.
- ¹⁴² Evans, D. A.; Hoveyda, A. H. *J. Am. Chem. Soc.* **1990**, *112*, 6447-6449.
- ¹⁴³ Evans, D. A.; Chapman, K. T.; Carreira, E. M. *J. Am. Chem. Soc.* **1988**, *110*, 3560-3578.
- ¹⁴⁴ Inanaga, J.; Hirata, K.; Saeki, H.; Katsuki, T.; Yamaguchi, M. *Bull. Chem. Soc. Jpn.* **1979**, *52*, 1989.
- ¹⁴⁵ Mundy, B. P.; Ellerd, M. G.; Favalaro, F. G. *Name Reactions and Reagents in Organic Synthesis*; 2nd ed. John Wiley & Sons, **2005**.

- ¹⁴⁶ (a) Dounay, A. B.; Overman, L. E. *Chem. Rev.* **2003**, *103*, 2945. (b) Shibasaki, M.; Boden, C. D. J.; Kojima, A. *Tetrahedron* **1997**, *53*, 7371.
- ¹⁴⁷ (a) Nicolaou, K. C.; Nold, A. L.; Milburn, R. R.; Schindler, C. S. Cole, K. P.; Yamaguchi J. *J. Am. Chem. Soc.* **2007**, *129*, 1760-1768. (b) Yokoyama, H.; Satoh, T.; Furuhashi, T.; Miyazawa, M.; Hirai, Y. *Synlett* **2006**, 2649-2651. (c) Gibson, S. E.; Lecci, C.; Whiteb, A. J. P, *Synlett* **2006**, 2929–2934. (d) Leonard, M. S.; Carroll, P. J.; Joullie, M. M. *J. Org. Chem.* **2004**, *69*, 2526-2531. (e) Geng, X.; Miller, M. L.; Lin, S.; Ojima, I. *Org. Lett.* **2003**, *5*, 3733-3736. (f) Harrowven, D. C.; Woodcocka, T.; Howesb, P. D. *Tetrahedron Lett.* **2002**, *43*, 9327-9329. (g) C aline, C.; Pattenden, G. *Synlett* **2000**, 1661-1663. (h) Jeong, S.; Chen, X.; Harran, P. G. *J. Org. Chem.* **1998**, *63*, 8640-8641. (i) Ma, S.; Negishi, E-C. *J. Am. Chem. Soc.* **1995**, *117*, 6345-6357. (j) Stocks, M. J.; Harrison R. P.; Teague, S. J. *Tetrahedron Lett.* **1995**, *36*, 6555-6558.
- ¹⁴⁸ Jeffery, T. *Termhedron* **1996**, *52*, 10113-10130.
- ¹⁴⁹ (a) Schinzer, D.; Bohm, O. M.; Altmann, K.-H.; Wartmann, M. *Synlett* **2004**, 1375. (b) Crimmins, M. T.; Caussanel, F. *J. Am. Chem. Soc.* **2006**, *128*, 3128-3129.
- ¹⁵⁰ Beletskaya, I. P.; Cheprakov, A. V. *Chem. Rev.* **2000**, *100*, 3009-3066.
- ¹⁵¹ Chinchilla, R.; Na'jera, C. *Chem. Rev.* **2007**, *107*, 874-922.
- ¹⁵² Green, T. W.; Wuts, P. G. M. *Protective Groups in Organic Synthesis*; 4rd ed. Wiley: New York, **2007**.
- ¹⁵³ Kocienski, P. *Protecting Groups*; 1st ed. Georg Thieme: Stuttgart, **1994**.
- ¹⁵⁴ Jarowicki, K.; Kocienski, P. *J. Chem. Soc., Perkin Trans. 1* **2000**, 2495–2527.
- ¹⁵⁵ Nelson, T. D.; Crouch, R. D. *Synthesis* **1996**, 1031–1069.
- ¹⁵⁶ Crouch, R. D. *Tetrahedron* **2004**, *60*, 5833-5871.
- ¹⁵⁷ Muzart, J. *Synthesis* **1993**, 11–27.
- ¹⁵⁸ (a) Ali, S. M.; Georg, G. I. *Tetrahedron Lett.* **1997**, *38*, 1703–1706. (b) Eggen, M.; Mossman, C. J.; Buck, S. B.; Nair, S. K.; Bhat, L.; Ali, S. M.; Reiff, E. A.; Boge, T. C.; Georg, G. I. *J. Org. Chem.* **2000**, *65*, 7792–7799. (c) Hart, B. P.; Verma, S. K.; Rapoport, H. *J. Org. Chem.* **2003**, *68*, 187–190.
- ¹⁵⁹ (a) Mori, Y.; Yaegashi, K.; Furukawa, H. *J. Am. Chem. Soc.* **1997**, *119*, 4557–4558. (b) Mori, Y.; Yaegashi, K.; Furukawa, H. *J. Org. Chem.* **1998**, *63*, 6200–6209. (c) Paterson, I.; Tudge, M. *Tetrahedron* **2003**, *59*, 6833–6849. (d) Nicolaou, K. C.; Sarabia, F.; Ninkovic, S.; Finlay, M. R. V.; Boddy, C. N. C. *Angew. Chem., Int. Ed.* **1998**, *37*, 81–84. (e) Storer, R. I.;

Takemoto, T.; Jackson, P. S.; Ley, S. V. *Angew. Chem., Int. Ed.* **2003**, *42*, 2521–2525. (f) Yakura, T.; Kitano, T.; Ikeda, M.; Uenishi, J. *Heterocycles* **2003**, *59*, 347–358.

¹⁶⁰ (a) Marshall, J. A.; Adams, N. D. *J. Org. Chem.* **2002**, *67*, 733–740. (b) Trost, B. M.; Corte, J. R.; Gudiksen, M. S. *Angew. Chem., Int. Ed.* **1999**, *38*, 3662–3664. (c) Williams, D. R.; Meyer, K. G. *J. Am. Chem. Soc.* **2001**, *123*, 765–766. (d) Marshall, J. A.; Ellis, K. C. *Org. Lett.* **2003**, *5*, 1729–1732. (e) Shimano, K.; Ge, Y.; Sakaguchi, K.; Isoe, S. *Tetrahedron Lett.* **1996**, *37*, 2253–2256. (f) Crimmins, M. T.; Stanton, M. G.; Allwein, S. P. *J. Am. Chem. Soc.* **2002**, *124*, 5958–5959. (g) Ito, M.; Yamanaka, M.; Kutsumura, N.; Nishiyama, S. *Tetrahedron Lett.* **2003**, *44*, 7949–7952.

¹⁶¹ (a) Kiyooka, S.; Shahid, K. A.; Goto, F.; Okazaki, M.; Shuto, Y. *J. Org. Chem.* **2003**, *68*, 7967–7978. (b) Shahid, K. A.; Mursheda, J.; Okazaki, M.; Shuto, Y.; Goto, F.; Kiyooka, S. *Tetrahedron Lett.* **2002**, *43*, 6377–6381.

¹⁶² (a) Ichikawa, S.; Shuto, S.; Minakawa, N.; Matsuda, A. *J. Org. Chem.* **1997**, *62*, 1368–1375. (b) Ogawa, A.; Tanaka, M.; Sasaki, T.; Matsuda, A. *J. Med. Chem.* **1998**, *41*, 5094–5107. (c) McCormick, J.; Li, Y.; McCormick, K.; Duynstee, H. J.; van Engen, A. K.; van der Marel, G. A.; Ganem, B.; van Boom, J. H.; Meinwald, J. *J. Am. Chem. Soc.* **1999**, *121*, 5661–5665. (d) Zhu, X.-F.; Williams, H. J.; Scott, A. I. *J. Chem. Soc., Perkin Trans. 1* **2000**, 2305–2306. (e) Chen, X.; Wiemer, A. J.; Hohl, R. J.; Wiemer, D. F. *J. Org. Chem.* **2002**, *67*, 9331–9339. (f) Dixon, D. J.; Ley, S. V.; Gracza, T.; Szolcsanyi, P. *J. Chem. Soc., Perkin Trans. 1* **1999**, 839–841.

¹⁶³ (a) Smith, A. B., III; Freeze, B. S.; Brouard, I.; Hirose, T. *Org. Lett.* **2003**, *5*, 4405–4408. (b) Pilli, R. A.; Victor, M. M. *Tetrahedron Lett.* **1998**, *39*, 4421–4424.

¹⁶⁴ (a) Trauner, D.; Schwarz, J. B.; Danishefsky, S. J. *Angew. Chem., Intl. Ed. Engl.* **1999**, *38*, 3542–3545. (b) Schinzer, D.; Bohm, O. M.; Altmann, K.-H.; Wartmann, M. *Synlett* **2004**, 1375. (c) Crimmins, M. T.; Caussanel, F. *J. Am. Chem. Soc.* **2006**, *128*, 3128–3129.

¹⁶⁵ (a) Tanemura, K.; Suzuki, T.; Horaguchi, T. *J. Chem. Soc., Perkin Trans. 1* **1992**, 2997–2998. (b) Paterson, I.; Cowden, C. J.; Rahn, V. S.; Woodrow, M. D. *Synlett* **1998**, 915–917.

¹⁶⁶ Chandrasekhar, S.; Mohanty, P. K.; Takhi, M. *J. Org. Chem.* **1997**, *62*, 2628–2629.

¹⁶⁷ (a) Koeller, S.; Lellouche, J.-P. *Tetrahedron Lett.* **1999**, *40*, 7043–7046. (b) Lellouche, J.-P.; Koeller, S. *J. Org. Chem.* **2001**, *66*, 693–696. (c) Lellouche, J.-P.; Kotlyar, V. *Synlett* **2004**, 564–571.

- ¹⁶⁸ (a) Wender, P. A.; Hegde, S. G.; Hubbard, R. D.; Zhang, L. *J. Am. Chem. Soc.* **2002**, *124*, 4956–4957. (b) Hwu, J. R.; Jain, M. L.; Tsai, F.-Y.; Tsay, S.-C.; Balakumar, A.; Hakimelahi, G. H. *J. Org. Chem.* **2000**, *65*, 5077–5088.
- ¹⁶⁹ Chen, M.-Y.; Lu, K.-C.; Lee, A. S.-Y.; Lin, C.-C. *Tetrahedron Lett.* **2002**, *43*, 2777–2780.
- ¹⁷⁰ Tandon, N.; Begley, T. P. *Synth. Commun.* **1997**, *27*, 2953–2959.
- ¹⁷¹ (a) Stork, G.; Manabe, K.; Liu, L. *J. Am. Chem. Soc.* **1998**, *120*, 1337–1338. (b) Matsushima, Y.; Itoh, H.; Nakayama, T.; Horiuchi, S.; Eguichi, T.; Kakinuma, K. *J. Chem. Soc., Perkin Trans. 1* **2002**, 949–958.
- ¹⁷² Fukuda, Y.; Shindo, M.; Shishido, K. *Org. Lett.* **2003**, *5*, 749–751.
- ¹⁷³ Nakamura, T.; Shiozaki, M. *Tetrahedron Lett.* **2001**, *42*, 2701–2704.
- ¹⁷⁴ Corey, E. J.; Roberts, B. E. *J. Am. Chem. Soc.* **1997**, *119*, 12425–12431.
- ¹⁷⁵ (a) Kurosawa, W.; Kan, T.; Fukuyama, T. *J. Am. Chem. Soc.* **2003**, *125*, 8112–8113. (b) Ohyabu, N.; Nishikawa, T.; Isobe, M. *J. Am. Chem. Soc.* **2003**, *125*, 8798–8805. (c) 30. Fuwa, H.; Sasaki, M.; Satake, M.; Tachibana, K. *Org. Lett.* **2002**, *4*, 2981–2984. (d) Carter, R. G.; Graves, D. E.; Gronemeyer, M. A.; Tschumper, G. S. *Org. Lett.* **2002**, *4*, 2181–2184.
- ¹⁷⁶ Shahid, K. A.; Mursheda, J.; Okazaki, M.; Shuto, Y.; Goto, F.; Kiyooka, S. *Tetrahedron Lett.* **2002**, *43*, 6377–6381.
- ¹⁷⁷ Fürstner, A.; Albert, M.; Mlynarski, J.; Metheu, M.; DeClerq, E. *J. Am. Chem. Soc.* **2003**, *125*, 13132–13142.
- ¹⁷⁸ Khan, A. T.; Mondal, E. *Synlett* **2003**, 694–698.
- ¹⁷⁹ Iimura, S.; Manabe, K.; Kobayashi, S. *J. Org. Chem.* **2003**, *68*, 8723–8725.
- ¹⁸⁰ Aiguade, J.; Hao, J.; Forsyth, C. J. *Org. Lett.* **2001**, *3*, 979–982.
- ¹⁸¹ (a) Bartoli, G.; Bosco, M.; Marcantoni, E.; Sambri, L.; Torregiani, E. *Synlett* **1998**, 209–211. (b) Bartoli, G.; Marcantoni, E.; Sambri, L. *Synlett* **2003**, 2101–2116.
- ¹⁸² Bartoli, G.; Cupone, G.; Dalpozzo, R.; De Nino, A.; Maiuolo, L.; Procopio, A.; Sambri, L.; Tagarelli, A. *Tetrahedron Lett.* **2002**, *43*, 5945–5947.
- ¹⁸³ Yadav, J. S.; Reddy, R. V. S.; Madan, C. *New J. Chem.* **2000**, *24*, 853–854.
- ¹⁸⁴ Crouch, R. D.; Polizzi, J. M.; Cleiman, R. C.; Yi, J.; Romany, C. A. *Tetrahedron Lett.* **2002**, *43*, 7151–7153.
- ¹⁸⁵ Ranu, B. C.; Jana, U.; Majee, A. *Tetrahedron Lett.* **1999**, *40*, 1985–1988.
- ¹⁸⁶ Sabitha, G.; Babu, R. S.; Rajkumar, M.; Srividya, R.; Yadav, J. S. *Org. Lett.* **2001**, *3*, 1149–1151.
- ¹⁸⁷ Yu, Z.; Verkade, J. G. *J. Org. Chem.* **2000**, *65*, 2065–2068.

- ¹⁸⁸ (a) Barros, M. T.; Maycock, C. D.; Sineriz, F.; Thomassigny, C. *Tetrahedron* **2000**, *56*, 6511–6516. (b) Barros, M. T.; Maycock, C. D.; Thomassigny, C. *Synlett* **2001**, 1146–1148.
- ¹⁸⁹ Vaino, A. R.; Szarek, W. A. *Chem. Commun.* **1996**, 2351–2352.
- ¹⁹⁰ Kartha, K. P. R.; Field, R. A. *Synlett* **1999**, 311–312.
- ¹⁹¹ Gopinath, R.; Patel, B. K. *Org. Lett.* **2000**, *2*, 4177–4180.
- ¹⁹² (a) Micalizio, G. G.; Roush, W. R. *Tetrahedron Lett.* **1999**, *40*, 3351–3354. (b) Paterson, I.; Oballa, R. M.; Norcross, R. D. *Tetrahedron Lett.* **1996**, *37*, 8581–8584. (c) Williams, D. R.; Ihle, D. C.; Plummer, S. V. *Org. Lett.* **2001**, *3*, 1383–1386. (d) Crimmins, M. T.; Katz, J. D.; McAlee, L. C.; Tabet, E. A.; Kirincich, S. *J. Org. Lett.* **2001**, *3*, 949–952. (e) Nicolaou, K. C.; Li, Y.; Sugita, K.; Monenschein, H.; Guntupalli, P.; Mitchell, H. J.; Fylaktakidou, K. C.; Vourloumis, D.; Giannakakou, P.; O'Brate, A. *J. Am. Chem. Soc.* **2003**, *125*, 15443–15454. (f) Crimmins, M. T.; King, B. W. *J. Am. Chem. Soc.* **1998**, *120*, 9084–9085. (g) Paterson, I.; Davies, R. D. M.; Marquez, R. *Angew. Chem., Int. Ed.* **2001**, *40*, 603–607.
- ¹⁹³ (a) Marshall, J. A.; Johns, B. A. *J. Org. Chem.* **1998**, *63*, 7885–7892. (b) Dounay, A. B.; Forsyth, C. J. *Org. Lett.* **1999**, *1*, 451–453.
- ¹⁹⁴ (a) Scheidt, K. A.; Tasaka, A.; Bannister, T. D.; Wendt, M. D.; Roush, W. R. *Angew. Chem., Intl Ed. Engl.* **1999**, *38*, 1652–1655. (b) Scheidt, K. A.; Bannister, T. D.; Tasaka, A.; Wendt, M. D.; Savall, B. M.; Fegley, G. J.; Roush, W. R. *J. Am. Chem. Soc.* **2002**, *124*, 6981–6990. (c) Carretero, J. C.; Arrayas, R. G. *Synlett* **1999**, 49–52.
- ¹⁹⁵ Anderson, J. C.; McDermott, B. P. *Tetrahedron Lett.* **1999**, *40*, 7135–7138.
- ¹⁹⁶ (a) Smith, A. B., III; Minbiole, K. P.; Verhoest, P. R.; Schelhaas, M. *J. Am. Chem. Soc.* **2001**, *123*, 10942–10953. (b) Smith, A. B., III; Verhoest, P. R.; Minbiole, K. P.; Lim, J. *Org. Lett.* **1999**, *1*, 909–912. (c) Gaul, C.; Njardarson, J. T.; Danishefsky, S. J. *J. Am. Chem. Soc.* **2003**, *125*, 6042–6043. (d) Paquette, L. A.; Braun, A. *Tetrahedron Lett.* **1997**, *38*, 5119–5122. (e) Paquette, L. A.; Gao, Z.; Ni, Z.; Smith, G. F. *Tetrahedron Lett.* **1997**, *38*, 1271–1274.
- ¹⁹⁷ (a) Lambert, W. T.; Burke, S. D. *Org. Lett.* **2003**, *5*, 515–518. (b) Miyashita, K.; Ikejiri, M.; Kawasaki, H.; Maemura, S.; Imanishi, T. *Chem. Commun.* **2002**, 742–743. (c) Miyashita, K.; Ikejiri, M.; Kawasaki, H.; Maemura, S.; Imanishi, T. *J. Am. Chem. Soc.* **2003**, *125*, 8238–8243.
- ¹⁹⁸ Wallace, G. A.; Scott, R. W.; Heathcock, C. H. *J. Org. Chem.* **2000**, *65*, 4145–4152.
- ¹⁹⁹ (a) Boge, T. C.; Wu, Z.-J.; Himes, R. H.; Vander Velde, D. G.; Georg, G. I.; Himes, R. H. *Bioorg. Med. Chem. Lett.* **1999**, *9*, 3047–3052. (b) Bode, J. W.; Carreira, E. M. *J. Org. Chem.* **2001**, *66*, 6410–6424. (c) Roush, W. R.; Dilley, G. J. *Tetrahedron Lett.* **1999**, *40*, 4955–4959.

- (d) Kusama, H.; Hara, R.; Kawahara, S.; Nishimori, T.; Kashima, H.; Nakamura, N.; Morihira, K.; Kuwajima, I. *J. Am. Chem. Soc.* **2000**, *122*, 3811–3820. (e) Martin, H. J.; Drescher, M.; Mulzer, J. *Angew. Chem., Intl Ed. Engl.* **2000**, *39*, 581–583. (f) Walker, M. A.; Johnson, T. D.; Huang, S.; Vyas, D. M.; Kadow, J. F. *Bioorg. Med. Chem. Lett.* **2001**, *11*, 1683–1685.
- ²⁰⁰ Wang, Y.-G.; Kobayashi, Y. *Org. Lett.* **2002**, *4*, 4615–4618.
- ²⁰¹ Ohmori, K.; Ogawa, Y.; Obitsu, T.; Ishikawa, Y.; Nishiyama, S.; Yamamura, S. *Angew. Chem., Intl Ed. Engl.* **2000**, *39*, 2290–2294.
- ²⁰² (a) Saitoh, T.; Suzuki, T.; Sugimoto, M.; Hagiwara, H.; Hoshi, T. *Tetrahedron Lett.* **2003**, *44*, 3175–3178. (b) White, J. D.; Sundermann, K. F.; Wartmann, M. *Org. Lett.* **2002**, *4*, 995–997. (c) Andrus, M. B.; Meredith, E. L.; Simmons, B. L.; Soma Sekhar, B. B. V.; Hicken, E. J. *Org. Lett.* **2002**, *4*, 3549–3552. (d) Andrus, M. B.; Meredith, E. L.; Hicken, E. J.; Simmons, B. L.; Glancey, R. R.; Ma, W. *J. Org. Chem.* **2003**, *68*, 8162–8169.
- ²⁰³ Smith, A. B., III; Lin, Q.; Doughty, V. A.; Zhuang, L.; McBriar, M. D.; Kerns, J. K.; Brook, C. S.; Murase, N.; Nakayama, K. *Angew. Chem., Int. Ed.* **2001**, *40*, 196–199.
- ²⁰⁴ Chapter 4.
- ²⁰⁵ Davalian, D.; Heathcock, C. H. *J. Org. Chem.* **1979**, *44*, 4458–4461.
- ²⁰⁶ For reviews, see: (a) Martens, J. *Methods of Organic Chemistry (Houben-Weyl)*; G. Thieme: New York, **1995**; Vol. E21d, p 4199. (b) Baxter, E. W.; Reitz, A. B. *Organic Reactions*; Wiley: New York, **2002**; Vol. 59, p 1. (c) Gomez, S.; Peters, J. A.; Maschmeyer, T. *Adv. Synth. Catal.* **2002**, *344*, 1037. (d) Tararov, V. I. Kadyrov, R.; Riermeier, T. H.; Fischer, C.; Boerner, A. *Adv. Synth. Catal.* **2004**, *346*, 561.
- ²⁰⁷ More recent examples are described in the following: (a) Apodaca, R.; Xiao, W. *Org. Lett.* **2001**, *3*, 1745. (b) Allegretti, M.; Berdini, V.; Candida Cesra, M.; Curti, R.; Nicolini, L.; Topai, A. *Tetrahedron Lett.* **2001**, *42*, 4257. (c) Gross, T.; Seayad, A. M.; Ahmad, M.; Beller, M. *Org. Lett.* **2002**, *4*, 2055. (d) Miriyala, B.; Bhattacharyya, S.; Williamson, J. S. *Tetrahedron* **2004**, *60*, 1463. (e) Itoh, T.; Nagata, K.; Miyazaki, M.; Ishikawa, H.; Kurihara, A.; Ohsawa, A. *Tetrahedron* **2004**, *60*, 6649.
- ²⁰⁸ (a) John, R. O. In *Comprehensive Biological Catalysis*; Sinnot, M., Ed.; Academic Press: London, UK, **1998**; Vol. 2, p 173. (b) Silverman, R. B. *The Organic Chemistry of Enzyme-Catalyzed Reactions*; Academic Press: London, UK, **2002**; p 428.
- ²⁰⁹ (a) Menche, D.; Hassfeld, J.; Li, J.; Menche, G.; Ritter, A.; Rudolph, S. *Org. Lett.* **2006**, *8*, 741; (b) Menche, D.; Arikan, F. *Synlett* **2006**, *6*, 841.

-
- ²¹⁰ (a) Kubota, H.; Koga, K. *Tetrahedron Lett.* **1994**, *35*, 6689; For reviews, see (b) Fache, F.; Schulz, E.; Tommasino, M. L.; Lemaire, M. *Chem. Rev.* **2000**, *100*, 2159.
- ²¹¹ Singh, S. *Chem. Rev.* **2000**, *100*, 925-1024.
- ²¹² (a) Wolfson, J. S.; Hooper, D. C. *Clin. Microbiol. Rev.* **1989**, *2*, 378; For some further examples, see: (b) Kappe, C. O. *Eur. J. Med. Chem.* **2000**, *35*, 1043; (c) de Vries, J. G. *Can. J. Chem.* **2001**, *79*, 1086; (d) Newman, D. J.; Cragg, G. M.; Snader, K. M. *J. Nat. Prod.* **2003**, *66*, 1022.
- ²¹³ Menche, D.; Böhm, S.; Li, J.; Rudolph, S.; Zander, W. *Tetrahedron Lett.* **2007**, *48*, 365.
- ²¹⁴ The cytotoxicity of simple aromatic amines is suggested to be initiated by nitrogen oxidation to the N-oxides: (a) Rjosk, H.-K.; Neumann, H.-G. *Zschr. Krebsforsch* **1971**, *75*, 209; (b) Hillesheim, W.; Jaeschke, H.; Neumann, H.-G. *Chem. Biol. Interact.* **1995**, *98*, 85.
- ²¹⁵ Menche, D.; Arikian, F.; Li, J.; Rudolph, S.; Sasse, F. *Bioorg. Med. Chem.* **2007**, *15*, 7311.
- ²¹⁶ Grube, A.; Assmann, M.; Lichte, E.; Sasse, F.; Pawlik, J. R.; Kock, M. *J. Nat. Prod.* **2007**, *70*, 504.

Curriculum Vitae

Jun Li

Birth: 14.11.1972, in Inner Mongolia, China

Nationality: Chinese

Education:

10/2005 – 10/2008 **Ph.D. thesis** with Dr. Dirk Menche (Medial Chemistry, Helmholtz Centre for Infection Research, Germany) and Professor Dr. Markus Kalesse (Department of Chemistry, University of Hannover, Germany.): “**Total Synthesis of Archazolid A and Studies Towards the Total Synthesis of Etnangien**”

01/2005 – 10/2005 **Diploma thesis** with Prof. Dr. Jürgen Liebscher (Humboldt University, Germany): “Synthesis of lipophilic nucleosidphosphates”.

10/2001 – 01/2005 **Studies of chemistry** and **biochemistry** at Humboldt University, Germany.

10/1999 – 10/2001 Studies of German at University of Paderborn, Germany.

07/1991 – 07/1995 Bachelor of Science (B. Sc.) in Chemistry at Teachers University of Inner Mongolia, China.

Experience:

07/1995 – 10/1999 Research assistant at Agricultural University of Inner Mongolia, China.

Publications:

1. D. Menche, J. Hassfeld, J. Li, G. Menche, A. Ritter, S. Rudolph
Hydrogen Bond Catalyzed Direct Reductive Amination of Ketones.
Org. Lett. **2006**; 8, 741-744.
2. D. Menche, J. Hassfeld, J. Li, S. Rudolph
Total Synthesis of Archazolid A.
J. Am. Chem. Soc. **2007**, 129, 6100-6101.
3. D. Menche, S. Böhm, J. Li, S. Rudolph, W. Zander
Synthesis of hindered tertiary amines by a mild reductive amination procedure.
Tetrahedron Lett. **2007**, 48, 365-369.
4. D. Menche, F. Arikan, J. Li, S. Rudolph
Directed Reductive Amination of β -Hydroxy-Ketones: Convergent Assembly of the Ritonavir/Lopinavir Core.
Org. Lett. **2007**, 9, 267-270.
5. D. Menche, F. Arikan, J. Li, S. Rudolph, F. Sasse
Efficient one-pot synthesis of biologically active polysubstituted aromatic amines.
Bio. Med. Chem. **2007**, 15, 7311–7317.
6. F. Arikan, J. Li, D. Menche
Diastereodivergent Aldol Reactions of Chiral Ethyl Ketones: Modular Access to (1,4)-syn and -anti Polypropionates.
Org. Lett. **2008**, 10, 3521-3524.
7. N. Brodersen, J. Li, O. Kaczmarek, A. Bunge, L. Löser, D. Huster, A. Herrmann, J. Liebscher
Nucleosides with 5'-Fixed Lipid Groups - Synthesis and Anchoring in Lipid Membranes.
Eur. J. Org. Chem. **2007**, 6060-6069.



Braunschweig, 14.10.2008

Name: Jun Li

NMR-Spectra

