

# **Use of Knowledge Based Systems for the Detection and Monitoring of Unplanned Developments**

Vom Fachbereich Bauingenieur- und Vermessungswesen  
der Universität Hannover  
zur Erlangung des Grades

**DOKTOR-INGENIEUR**

genehmigte Dissertation  
von

MSc. Faith Njoki Karanja

geboren am 31.12.1968, in Nakuru, Kenia

---

**Hannover, 2002**

**Referenten:**

**Prof. Dr.-Ing. C. Heipke**  
**Prof. Dr.-Ing. mult. G. Konecny**

**Tag der mündlichen Prüfung:**

**28. Juni 2002**

### ABSTRACT

Within the context of an urban land use, two general status can be distinguished namely developed land (residential, industrial area, construction area, etc), and reserved land (forest, water bodies, garden, parks, open area etc). However, not all developed land is legal or formal a phenomena prevalent in developing countries. For the planners it is important to have the capacity to detect, localize and predict the trend of this phenomena in order to facilitate reaction planning. In this regard, the main objective of this study is to develop a methodology that exploits existing planning data and urban land use drivers in combination with remotely sensed imagery for the detection and quantification of unplanned developments and subsequently facilitate in monitoring their trends. Since planning is a continuous process, remotely sensed data lends itself to a good source of information pertaining to the extent of developed and reserved areas at any given epoch. The methodology has been sub-divided into four modules, namely the interpretation, detection, trend prediction and the evaluation. Knowledge based image interpretation, namely rule based system was employed in the extraction of developed and reserved areas from multispectral image data. As input into the interpretation process four image cues i.e. NDVI, Texture, Edge Density, and unsupervised classification have been tested. Experience has shown that data reduction and refinement prior to its incorporation in the knowledge base enables few rules to be established and thereby minimizing rule correlation. However, knowledge representation is a challenge and especially when it involves rules association. Acceptable results have been obtained which imply that such a technique is promising. Additional information e.g. GIS data would nevertheless be useful as a guide in the extraction of objects like parking areas and some complex built up areas (e.g. buildings), roads, etc thus improving the results. For the detection of unplanned developments, the constraints of planning data has been exploited. Specifically, planning data has been used in combination with remotely sensed data depicting **As It Were** situation to generate **As It Should Be** scenario with specific emphasis on the new legal/allowable developments. This formed a backdrop for the detection of unplanned developments, which essentially translates to the difference between the **As It Should Be** situation and **As It IS** within the planning and implementation time frame. Prototype experiments carried out show that this is a feasible technique and can easily be implemented for fast detection in comparison to the current ad hoc field techniques. In the trend prediction of unplanned developments, land use drivers based on compatibility of land uses, transport network, and hydrography sources are used to establish their influence on the new developed areas. Results show that existing land uses influence highly new developed areas. A combination effect of these influences (land use drivers) when employed results in stratification of pressure zones into fuzzy blocks ranging from those which are likely to undergo extensions of unplanned developments to those which are unlikely. Such information could enable planners develop a program in preparation for such eventualities and prioritise areas that require urgent reaction planning. For the evaluation of the results, both qualitative and quantitative evaluation techniques have been tested namely visual comparison, polygon-pixel count and kappa index. Comparable results have been obtained based on these three techniques for the interpretation and detection modules. The choice of which technique to apply depends on the application and the level of detail required. In conclusion, this study has demonstrated that a 'complete package' that will enable planners to detect and predict the trend of unplanned developments is feasible. In order to ensure success, planning should be viewed as a collective responsibility, where all stakeholders are participants. Further, sound land law system that

ensures land accessibility and security of tenure as well as promote transparency in land allocation issues should be implemented and enforced.

**Keywords: Knowledge based-Image Interpretation, Detection of Unplanned Developments, Urban Growth Simulation.**

### ZUSAMMENFASSUNG

Urbane Landnutzung kann allgemein in zwei Bereiche unterteilt werden, nämlich entwickelte Gebiete (Siedlungsgebiete, Industrieflächen, Baustellen etc.) und Schutzzonen (Waldgebiete, Wasserflächen, Gärten, Parks, Freiflächen etc.). Jedoch ist insbesondere in Entwicklungsländern nicht alles entwickelte Land legal zugelassen oder geplant. Für die Planer ist es wichtig, eine Möglichkeit zu haben, die Entwicklung dieser Phänomene zu erkennen, zu lokalisieren und vorherzusagen, um darauf rechtzeitig zu reagieren. Daher ist das Hauptziel der vorliegenden Arbeit die Entwicklung einer Methodik, welche vorhandene Planungsdaten und Landnutzungseinflüsse in Kombination mit Fernerkundungsdaten nutzbar macht für die Erkennung und Quantifizierung ungeplanter Entwicklungen, und die Beobachtung dieser Trends zu erleichtern. Da Planung ein kontinuierlicher Prozess ist, sind Fernerkundungsdaten eine nützliche Informationsquelle für die Erhebung bebauter und unbebauter Flächen zu jedem beliebigen Zeitpunkt. Die Methodik ist unterteilt in vier Module, nämlich Interpretation, Erkennung, Trendprognose und Evaluierung. Für die Interpretation entwickelter und geschützter Bereiche wurde das Verfahren der wissensbasierten Bildinterpretation von multispektralen Daten angewendet. Vier verschiedene Merkmale, nämlich NDVI, Textur, Kantendichte und das Ergebnis einer unüberwachten Klassifizierung wurden als Ausgangsbasis für die Interpretation herangezogen. Die Erfahrung zeigt, dass Datenreduktion und -veredelung vor der Integration in die Wissensdatenbank die Verwendung nur weniger Regeln erlaubt und dadurch die Korrelation reduziert. Die Wissensrepräsentation stellt eine besondere Herausforderung im Zusammenhang mit der Verknüpfung von Regeln dar. Aufgrund der erzielten akzeptablen Resultate erweist sich eine solche Technik als vielversprechend. Jedoch könnten Zusatzinformationen wie z.B. GIS-Daten die Resultate der Objektextraktion z. B. von Parkplätzen und komplexer Bebauungsgebiete, Straßen etc. verbessern. Für die Erkennung ungeplanter Entwicklungen wurde die Einschränkungen von Planungsdaten ausgenutzt. Insbesondere wurden Planungsdaten in Kombination mit Fernerkundungsdaten untersucht, um von der IST-Situation zur SOLL-Prognose zu gelangen, mit besonderem Gewicht auf den neuen legalen und erlaubten Entwicklungen. Dies bildet den Hintergrund für die Erkennung ungeplanter Entwicklungen, welche zum Unterschied zwischen der SOLL-Situation und der IST-Situation im Planungszeitraum führt. Prototypexperimente zeigten, dass es sich hierbei um eine durchführbare Technik handelt, welche, im Unterschied zu derzeitigen ad hoc Feld-Techniken leicht für schnelle Detektion implementiert werden kann. Für die Trendprognose ungeplanter Entwicklungen wurden der Einfluss von Landnutzung, Straßen- und Gewässernetz auf neu entwickelte Gebiete untersucht. Die Ergebnisse zeigen einen großen Einfluss existierender Landnutzungen auf neue Entwicklungsgebiete. Eine Kombination und Verschneidung dieser Einflüsse innerhalb von Pufferzonen resultiert in Fuzzy - ähnlichen Straten, die auf einer Skala von wahrscheinlichen zu unwahrscheinlichen ungeplanten Entwicklungsgebieten rangieren. Derartige Information könnte den Planer dazu dienen ein entsprechendes Vorsorgeprogramm für solche Eventualitäten zu entwickeln und Prioritätsgebiete zur unmittelbaren Reaktionsplanung festzulegen. Zur Genauigkeitsuntersuchung wurden sowohl qualitative als auch quantitative Techniken untersucht u.a. der visuelle Vergleich, „Polygon Pixel Count“ und der Kappa-Index. Für die Interpretations- und Detektionsmodule sind dabei

mit diesen 3 Techniken vergleichbare Ergebnisse erzielt worden. Die Wahl der einzusetzenden Technik hängt von der Anwendung und dem benötigten Detaillierungsgrad ab. Zusammenfassend hat diese Arbeit gezeigt, dass es für die Detektion und Vorhersage ungeplanter Entwicklungen möglich ist dem Planer ein vollständiges Instrumentarium an die Hand zu geben. Um den Erfolg zu garantieren sollte die Planung unter Beteiligung aller Interessengruppen auf kollektiver Verantwortlichkeit beruhen. Des weiteren sollte möglichst ein umfassendes Grundrechtssystem eingeführt werden, das den Zugriff auf Grund und Boden, als auch Sicherheit und Transparenz im Grundstücksverkehr gewährleistet.

**Stichworte:** Wissensbasierte Bildinterpretation, Erkennung ungeplanter Entwicklungen, Urbane Entwicklungssimulation.

## ACKNOWLEDGEMENTS

---

### ACKNOWLEDGEMENTS

I would like to express my gratitude to the following people for their contributions, guidance, challenge and inspiration during the course of this research work.

To Prof. Dr.-Ing. mult. G. Konecny, for having given me the opportunity to pursue my research work at the Institute of Photogrammetry and GeoInformation, University of Hannover and for his contribution, suggestions and extensive knowledge and materials relevant to this study.

To Prof. Dr.-Ing. C. Heipke for the smooth transition in the supervision of this work. His encouragement, insight and invaluable contribution has raised the level of my efforts immensely.

For regular contacts and assistance, I would like to acknowledge Dr. Peter Lohmann who always found time for me throughout the course of this work.

To all the staff members of the Institute who in one way or the other supported me and made my stay in Germany worthwhile.

To DAAD, for faithfully providing the financial support, without which I would not have successfully completed this research work.

I would also want to thank the Survey Department (Landesvermessung Geobasisinformation, Niedersachsen (LGN)) and UCLAS, University of Dar-esalaam through the intervention of Dr.Mtalo, for availing the data sets used in this study.

To UNECA (Nino Fluck) and GTZ (Willi Zimmermann) for providing me with an opportunity to do some practical work, through the courtesy of Prof. Dr.-Ing. G. Konecny, within the course of my research work.

To all my friends who by word of telephone or e-mail offered me some encouragement, I am truly grateful.

To my parents, brothers, sisters, nieces and nephews for their prayers and word of encouragement throughout my stay in Germany, God bless you.

I am greatly indebted to my niece Lucy and my two sisters-in-law Veronica and Salome for having assisted my husband in taking care of my son and giving him all the love and the attention during my absence, thank you very much and may God bless you abundantly.

Last but not least to the two most important people in my life, my husband Anthony and son Wesley for their patience, encouragement, loving me unconditionally and helping me get through a difficult phase in my life. Thank you for having faith in me

DEDICATION

---

DEDICATION

**To my  
husband Anthony Karanja Wanyoro,  
and Son Wesley Wanyoro Karanja**

TABLE OF CONTENTS

<b>ABSTRACT</b>	i
<b>ZUSAMMENFASSUNG</b>	ii
<b>ACKNOWLEDGEMENTS</b>	iv
<b>DEDICATION</b>	v
<b>TABLE OF CONTENTS</b>	vi
<b>LIST OF ABBREVIATIONS</b>	ix
<b>LIST OF FIGURES</b>	x
<b>LIST OF TABLES</b>	xiii

PART I GENERAL INTRODUCTION AND THE STATE OF THE ART

<b>CHAPTER 1 INTRODUCTION</b>	2
1.1 Background knowledge	2
1.2 Objectives of the study	7
1.3 Overview of the methodology	7
1.4 Organization of the report	9
<b>CHAPTER 2 A REVIEW OF URBAN FORM AND THE ROLE OF REMOTE SENSING IN THE DETECTION AND TREND MODELLING OF URBAN DYNAMICS</b>	10
2.1 Urban Morphology and Growth as Perceived from the Fractal Geometry Paradigm	10
2.2 Role of Remote Sensing for Urban Studies	11
2.3 Change Detection Algorithms	13
2.3.1 Change Enhancement Techniques	14
2.3.2 Nature of Change Detection Techniques	15
2.3.3 Technical Aspects of Remote Sensing Data	16
2.4 Review of Urban Prediction Models	18
2.5 Sought System Functionalities	20

PART II THEORETICAL CONCEPT

<b>CHAPTER 3 IMAGE INTERPRETATION MODULE</b>	23
3.1 Overview	23
3.2 Features Extraction and Labeling	24
3.2.1 Features Extraction	26
3.2.2 Features Labeling	31
3.3 Knowledge Base Rule	32
3.3.1 Knowledge Domain	32
3.3.2 Representation of Knowledge	34
3.4 Knowledge-Based Interpretation	36
3.4.1 Conflict Set Generation	36
3.4.2 Resolution of the conflict set	36
3.5 Final class representation	37



<b>CHAPTER 4 DETECTION AND TREND MONITORING MODULES</b>	<b>39</b>
4.1 Overview	39
4.2 Unplanned Developments and Their Trend Prediction as Indicators For an Urban Environment	39
4.2.1 Technical Prerequisites	40
4.3 Detection of Unplanned Developments Module	41
4.3.1 Input Data for the Detection of Unplanned Developments	42
4.3.2 Definition of the <i>As it Should Be</i> Situation	44
4.3.3 The Detection of Unplanned Developments Process	45
4.4 Prediction of the Extension of Unplanned Developments	46
4.4.1 Input Data for the Prediction of the Extension of Unplanned Developments	47
4.4.2 Pressure Zones Modeling	49
4.4.3 Definition of Modeled Extensions of Unplanned Developments	50
<b>CHAPTER 5 EVALUATION MODULE</b>	<b>51</b>
5.1 Overview	51
5.2 Reference Data	52
5.2.1 Sources of Reference Data	52
5.2.2 Technical Aspects of Reference Data	53
5.3 Evaluation Indices	54
5.3.1 Visual Comparison	55
5.3.2 Polygon-Pixel Statistics	56
5.3.3 Kappa-Index	58
5.4 Comparison of the Evaluation Indices	59
<b>PART III TESTS AND FINAL REMARKS</b>	
<b>CHAPTER 6 PROTOTYPE EXPERIMENTS AND RESULTS</b>	<b>62</b>
6.1 Overview	62
6.2 Test sites and Data	62
6.3 Pre-processing	64
6.4 Image interpretation	65
6.4.1 Features Extraction and Labeling	65
6.4.2 Knowledge-Based Rules	72
6.4.3 Knowledge-Based Interpretation	85
6.4.4 Interpretation Results	90
6.4.5 Evaluation of the Interpretation	93
6.5 Detection of unplanned developments	94
6.5.1 Prognosis Indicators	94
6.5.2 Results of the Detection of Unplanned Developments	94
6.5.3 Evaluation of the Detection of Unplanned Developments	97
6.6 Monitoring Trend of Unplanned Developments	98
6.6.1 Trend Modeling	98
6.6.2 Results of Trend Monitoring	100
6.6.3 Evaluation of the Trend Monitoring	106
6.7 Discussion of the Results	108

## TABLE OF CONTENTS

---

<b>CHAPTER 7 SUMMARY, CONCLUSIONS AND RECOMMENDATIONS</b>	<b>110</b>
7.1 Summary	110
7.2 Conclusions and Recommendations	111
<b>REFERENCES</b>	<b>114</b>
<b>APPENDIX</b>	
<b>Curriculum Vitae</b>	<b>123</b>

**LIST OF ABBREVIATIONS**

AEZ	Agro-Ecological Zones
CDI	City Development Index
CEOS	Committee on Earth Observation Satellites
CORINE	Coordinating Information on the Environment
CSD	Commission for Sustainable Development
DTC	Decision Tree Classifiers
EEA	European Environment Agency
EIS-SSA	Environmental Information System-Sub-Saharan Africa
EMR	Extended Metropolitan Regions
FAO	Food and Agricultural Organisation
GCP	Ground Control Points
GDP	Growth Domestic Product
GDTA	Groupement pour le De´veloppement de la Teledetection Aerospatiale
GRID	Global Resource Information Database
IFOV	Instantaneous Field Of View
ISD	Indicators of Sustainable Development
ITA	Italian Trust Fund
LCCS	Land Cover Classification System
LQI	Land Quality Indicators
LVQ	Learning Vector Quantization
MLC	Maximum-Likelihood Classifier
MLP	Multi-Layer Perceptrons
MOLAND	Monitoring Land Use Changes
MURBANDY	Monitoring URBAN DYnamics
OSS	Observatoire du Sahara et du Sahel/ OSS
SDP	Sustainable Dar-esalaam Project
UCLAS	University College of Lands Architecture and Settlements
UMP	Urban Management Programme
UNCED	United Nations Committee
UNEP	United Nations Environmental Programme
UNHCS	United Nations Centre for Human Settlement
UNITAR	United Nations Institute for Training and Research
U.S. EPA	United States Environmental Protection Agency

**LIST OF FIGURES**

Fig. 1-1	Action Levels of Urban Planning	4
Fig. 1-2	Methodology Overview	8
Fig. 2-1	Spontaneous developments	10
Fig. 2-2	Planned Developments	11
Fig. 2-3	Change Detection Techniques	13
Fig. 2-4	Typical Problems of Change Enhancement Techniques	14
Fig. 2-5	Planning Models	19
Fig. 3-1	Image Interpretation Module	23
Fig. 3-2	Components of the Image Interpretation Module	24
Fig. 3-3	Interpretation Key Showing Class Examples	25
Fig. 3-4	Original 10m Spot Panchromatic image of Dar-esalaam	26
Fig. 3-4a	3 x 3, texture	26
Fig. 3-4b	31 x 31, texture	27
Fig. 3-4c	61 x 61, texture	27
Fig. 3-5	Original 1m aerial image of Hannover Expo Region	27
Fig. 3-5a	3 x 3, texture	27
Fig. 3-5b	31 x 31, texture	28
Fig. 3-5c	61 x 61, texture	28
Fig. 3-6	Edge density Image	29
Fig. 3-7	NDVI image	30
Fig. 3-8	Clustered Image	31
Fig. 3-9	Knowledge Sources	33
Fig. 3-10	Decision Tree Concept	35
Fig. 3-11	Class Aggregation	38
Fig. 4-1	Detection and Trend Modelling Modules	39
Fig. 4-2	Indicator Category and Type(Modified after Jesinghaus, 1999)	40
Fig. 4-3	The detection of unplanned developments	42
Fig. 4-4	Future Land Use Map	43
Fig. 4-5	Building Plan Number1557	44
Fig. 4-6	The definition of the concept of <b>As It Should Be</b> Situation	45
Fig. 4-7	The Concept underlying the detection of unplanned developments	46
Fig. 4-8	The Prediction of the Unplanned Development Process	47
Fig. 4-9	Land use coverage with an overlay of river and main roads coverages	48
Fig. 4-10	The concept of modeling pressure zones based on the existing urban Configuration	49
Fig. 4-11	Pressures Zones Definition	49
Fig. 5-1	Evaluation Module	51
Fig. 5-2a	Reference raster data	55
Fig. 5-2b	Reference vector data	55
Fig. 5-2c	Interpreted data	55
Fig. 5-2d	Overlay of interpreted data with vector reference data	56
Fig. 6-1	Hannover Study Site	62
Fig. 6-2	Dar-esalaam Study Site	63
Fig. 6-3a	Landsat 1995 Texture Variables	67
Fig. 6-3b	1995 High Edge Variables	67
Fig. 6-3c	1995, NDVI	68
Fig. 6-3d	1995, Clustered layer	68
Fig. 6-4a	Landsat 2000, Texture variables	69
Fig. 6-4b	2000, High Edge Variables	69

## LIST OF FIGURES

---

Fig. 6-4c	2000, NDVI	70
Fig. 6-4d	2000, Clustered layer	70
Fig. 6-5a	SPOT 1998, Texture variables	71
Fig. 6-5b	1998, High Edge Variables	71
Fig. 6-5c	1998, NDVI	72
Fig. 6-5d	1998, Clustered Layer	72
Fig. 6-6a	1995, Landsat image before histogram matching	73
Fig. 6-6b	1995, Landsat image after histogram matching	73
Fig. 6-7a	2000, Landsat image before histogram matching	73
Fig. 6-7b	2000, Landsat image after histogram matching	73
Fig. 6-8	Multispectral Image Interpretation Process	74
Fig. 6-9a	The Decision Tree for the general rule base of the Developed areas	76
Fig. 6-9b	The Decision Tree for the general rule base of the Reserved areas	77
Fig. 6-10a	The Decision Tree for the 1995, Hannover Developed Areas	78
Fig. 6-10b	The Decision Tree for the 1995, Hannover Reserved Areas	80
Fig. 6-11a	The Decision Tree for the 2000, Hannover Developed Areas	81
Fig. 6-11b	The Decision Tree for the 2000, Hannover Reserved Areas	82
Fig. 6-12a	The Decision Tree for the 1998, Dar-esalaam Developed Areas	83
Fig. 6-12b	The Decision Tree for the 1998, Dar-esalaam Reserved Areas	84
Fig. 6-13a	Original Landsat TM 1995	85
Fig. 6-13b	Test Case 1	85
Fig. 6-14	Test Case 2	86
Fig. 6-15	Test Case 3	87
Fig. 6-16	Landsat 1995 image	87
Fig. 6-17	Landsat 2000 image after histogram matching	87
Fig. 6-16a	1995 Landsat image case 1	88
Fig. 6-17a	2000 Landsat image case 1	88
Fig. 6-16b	1995 Landsat image case 2	88
Fig. 6-17b	2000 Landsat image case 2	88
Fig. 6-16c	1995 Landsat image case 3	89
Fig. 6-17c	2000 Landsat image case 3	89
Fig. 6-16d	1995 Landsat image case 4	89
Fig. 6-17d	2000 Landsat image case 4	89
Fig. 6-18	1995, Landsat TM image	90
Fig. 6-19	1995, Landsat TM interpreted image	90
Fig. 6-18a	1995, Landsat TM zoomed image	90
Fig. 6-19a	1995, Landsat TM interpreted zoomed image	90
Fig. 6-20	2000, Landsat TM image	91
Fig. 6-21	2000, Landsat TM interpreted image	91
Fig. 6-20a	2000, Landsat TM zoomed image	91
Fig. 6-21a	2000, Landsat TM interpreted zoomed image	91
Fig. 6-22	1998, Enhanced SPOT image	92
Fig. 6-23	1998, Enhanced SPOT interpreted image	92
Fig. 6-22a	1998, Enhanced SPOT zoomed image	92
Fig. 6-23a	1998, Enhanced SPOT interpreted zoomed image	92
Fig. 6-24a	1995 Manually Interpreted Image	95
Fig. 6-25a	Planning Data	95
Fig. 6-26a	Prognosis Information	95
Fig. 6-27a	Landsat 2000 interpreted image	95
Fig. 6-24b	1995 Manually Interpreted Image	96
Fig. 6-25b	Planning Data	96

## LIST OF FIGURES

---

Fig. 6-26b	Prognosis Information	97
Fig. 6-27b	Landsat 2000 interpreted image	97
Fig. 6-28	Trend Prediction Rule Base	99
Fig. 6-29	1992, Land Use Map	100
Fig. 6-30	1998, Interpreted Image	100
Fig. 6-31	Newly Developed Areas, 1998	101
Fig. 6-32	River Coverage	102
Fig. 6-33	River buffer	102
Fig. 6-34	Road Coverage	103
Fig. 6-35	Road buffer	103
Fig. 6-36	Informal developments coverage	104
Fig. 6-37	Unplanned developments buffer	104
Fig. 6-38	Comparison of new developed areas based on river, road and unplanned developments	105
Fig. 6-39	Modeled scenarios of possible extensions of unplanned developments	106
Fig. 6-40	Major Informal Settlements, 1999 (Source 1992 Aerial photographs, Field survey, 1999)	107

**LIST OF TABLES**

Table 1-1	Some World Urbanization rates from 1980-2010 (Source: UNCHS, 1999)	5
Table 5-1	Assessment of extracted developed and reserved areas based on polygon-pixel count algorithm.	56
Table 5-2	Assessment of detected unplanned developments based on polygon-pixel count	57
Table 5-3	Assessment of the prediction model results on the extension of unplanned developments based on polygon-pixel count	57
Table 5-4	Evaluation Indices Comparison	59
Table 6-1a	Global Knowledge Rules	75
Table 6-1b	General Rule base for the Developed Areas	75
Table 6-1c	General Rule base for the Reserved Areas	76
Table 6-2a	Hannover Landsat 1995, Rule base for the Developed Areas	78
Table 6-2b	Hannover Landsat 1995, Rule base for the Reserved Areas	79
Table 6-3a	Hannover Landsat 2000, Rule base for the Developed Areas	81
Table 6-3b	Hannover Landsat 2000, Rule base for the Reserved Areas	82
Table 6-4a	Dar-esalaam SPOT 1998, Rule base for the Developed Areas	83
Table 6-4b	Dar-esalaam SPOT 1998, Rule base for the Reserved Areas	84
Table 6-5	Accuracy evaluation for the interpretation of the 1995, Hannover Landsat image	93
Table 6-6	Accuracy evaluation for the interpretation of the 2000, Hannover Landsat image	93
Table 6-7	Accuracy evaluation for the interpretation of the 1998, Dar-esalaam SPOT image	93
Table 6-8a	Accuracy evaluation for the Detection of Unplanned Developments (Ideal Situation)	97
Table 6-8b	Accuracy evaluation for the Detection of Unplanned Developments (Real Situation)	98

**PART I : GENERAL INTRODUCTION AND THE  
STATE OF THE ART**



# CHAPTER 1

## INTRODUCTION

### 1.1 Background Knowledge

#### General knowledge

Land cover plays an important role for the description and study of the environment. The productivity of the terrestrial ecosystems can be defined in terms of land and its cover. Moreover it is the easiest detectable indicator of human interventions on land. Early geographic studies in the 1920's enabled research work related to urban land use development and problems to be conducted. Since then a number of problems have been addressed worldwide which cover a broad range of Urban Planning, Economics, Sociology, and Transportation, etc. This can be attributed to the increase in data sources namely remotely sensed and collateral information and frameworks (GIS) that enable their integration. Nevertheless, the diversity and complexity of real world problems necessitate application dependent approaches, e.g. the mushrooming of unplanned developments is a unique phenomena prevalent in developing countries, in order to effectively address the problem presented. Hence, to enable reaction and strategic planning to be executed, there is need for a sustainable system that will constantly ensure that land use patterns, specifically the extent and trend of unplanned developments is available in usable format and reliable in terms of temporal and spatial resolutions.

In Africa, more than 10 years ago, spatial analysis capabilities were limited, whereby each discipline generated their own data set, worse even for the same area and the result is obviously data redundancy and duplication of efforts. In an attempt to address this situation, several agencies e.g. FAO AFRICOVER, Environmental Information System-Sub-Saharan Africa (EIS-SSA), the Sahara and Sahel Observatory (Observatoire du Sahara et du Sahel/OSS) in conjunction with United Nations Institute for Training and Research (OSS/UNITAR), Committee on Earth Observation Satellites (CEOS), COPINE, UNEP/GRID have initiated programs that are aimed at facilitating environmental management, monitoring and information exchange in Africa. Specifically Africover [1999] identified the problems both at local and regional level as inconsistencies in coverage, scales, classification systems and databases of spatial information. The consequences thereof are difficulties in data exchange and update; inefficient national databases; and inefficient use of finances and human resources. Nevertheless, little has changed today as there is still independent data generation. Consequently, the way forward has been identified as one that is geared towards enhancing spatial analysis capabilities and promoting partnership between disciplines and institutions, organisations and countries as an essential step in improving the synergies between the different systems. At a global level, FAO embarked on establishing a Land Cover Classification System (LCCS) to address the in homogeneity arising from heterogeneous nomenclature of land cover information in different countries. The first full operational version of the classification and software program was developed for implementation by the Italian trust fund GCP/RAF/287/ITA Africover East Africa Project in collaboration with the FAO Soil Resources, Management and Conservation Service (AGLS). [FAO AFRICOVER Programme, 1998].

The FAO AFRICOVER, is comparable to the European CORINE Land Cover database program [Perdigao and Annoni, 1997] whose main objective is to prepare and implement a reliable and geo-referenced information on natural resources at sub-national, national and regional levels. Specifically it has taken the task of establishing for the whole of Africa a

digital geo-referenced database on land cover and a geographic reference (geodesy, toponymy, roads, hydrography) at a scale of 1:250,000 or 1:200,000 (but for small countries and specific areas at a scale of 1:100,000) using satellite remote sensing data. Further, generalization of this base would be made at a scale of 1:1,000,000. In order to effectively utilize remote sensing and GIS technologies for land cover inventory and monitoring and to ensure system sustainability, Africover has also undertaken the responsibility of capacity building in various countries.

On the other hand, urban applications require much larger scales and therefore details, for instance, maps used for planning purposes by local governments are usually in the range of 1:10,000 to 1:50,000 which implies that satellite imagery are good candidates particularly where security restrictions, costs and time prohibit the use of aerial photography. On a continental scale and within the framework of an urban environment, MOLAND (MONitoring LAND) use changes is such a project initiated by the European Environment Agency (EEA) with an aim of providing the status of urban environments in Europe. The first results of this endeavour were presented by MURBANDY (Monitoring Urban Dynamics) projects based on Ruhr Area (MURBANDY, 2000). However, use of the very high resolution satellite imagery e.g. Ikonos, are still out of reach for most municipal applications due to cost constraints and therefore sources from Spot, IRS and Landsat TM images will continue to be explored. The coarse spatial resolution is of course a limitation in the urban application particularly in the assessment of e.g. housing units and estimation of population, etc. Techniques and tools have been developed to deal with low spatial resolution data e.g. through data fusion [Pohl and Genderen, 1998] and use of sub-pixel classifier algorithms [Petrou, 1999, Ji and Jensen, 1999].

### **Role of Urban Planning Departments**

Town planning is a very complex activity and more so due to the various stakeholders involved e.g., city planners, engineers, architects, surveyors, politicians, civilians, etc, who differ in perception in terms of methodological, instrumentation and implementation. The driving factors include political and administration, socio-economic, etc. Figure 1-1 shows the action levels of urban planning both in an ideal situation where the plans are adhered to and in a real situation characterized by spontaneous/unplanned<sup>1</sup> developments. In the former, this involves establishing the town layout by mapping its composition based on remotely sensed data, field surveys or existing maps. This information is then used in combination with planning drivers e.g. environmental, economical, and social for strategic planning, to derive town models. The selection of which town model to implement can be based on criteria such as profitability, compatibility with existing land uses, environmental friendliness, etc which gives rise to planned developments. The town layout should then be updated to reflect this new developments. On the other hand not all new developments are planned, and hence incidences of unplanned developments do arise. This necessitate reaction planning which could involve upgrading and ensuring security of tenure. Likewise, they have to be incorporated into the town layout.

---

<sup>1</sup> Spontaneous and unplanned developments as used in this study are synonymous

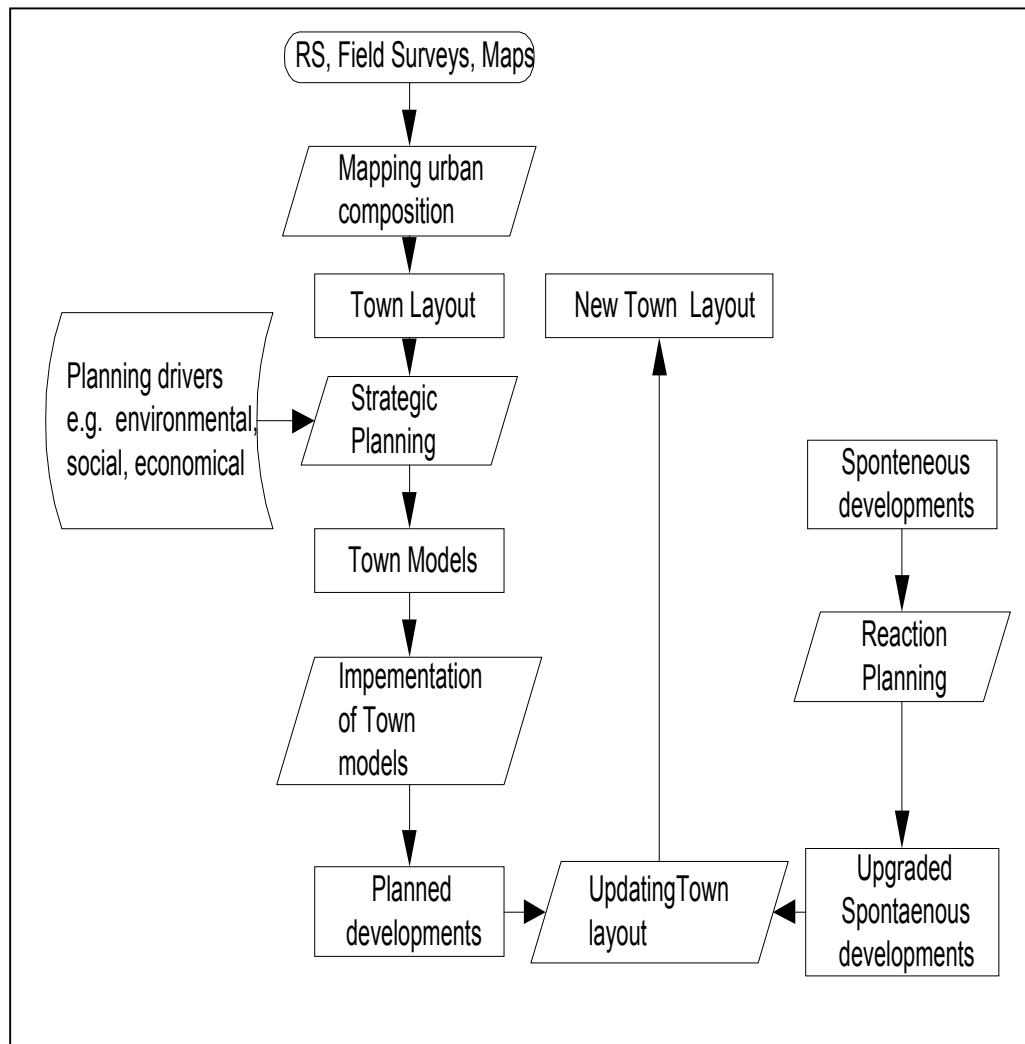

Fig. 1-1: Action Levels of Urban Planning

The challenge of spontaneous or uncontrolled developments are two folds:

- It makes it difficult for the local governments to provide public services e.g. schools, hospitals, fire stations, security, quality streets, parks and playgrounds.
- It leads to a reduction in available open space and on the other hand increase in more automobile use and hence pollution.

A robust formulation of a town model takes into consideration :[Gupta et al, 2001]

- Present scenario
- Available resources (natural/physical)
- Nature of the local needs & problems
- Priorities of development programs allocated to the different socio-economic activities and trends.

The complexity and disparities in the development levels in any given region has necessitated a modular approach which sub-divides a region into blocks having similar infrastructure set-ups and therefore needs. This makes the execution of development projects more feasible.

### Challenges in the context of Urban Environments

There is an increasing need for effective urban planning in developing countries which is posing a major challenge to both planners and managers. There are two main problems that are prevalent namely:

- Population explosion which goes up to 10% p.a
- Urban area expansion that is in the range of 50-100% in a span of ten years.

It is interesting to note that urban population increases in developed countries are more due to urban migration as opposed to natural increases e.g. in Istanbul [Maktav and Erbek, 2001].

A summary of some world urban population trend between 1980 and 2010 is shown in table 1-1. It is evident that in 1980 some African cities like Lagos, Dhaka and Cairo were not considered as mega cities, but this situation changed in the 1990s with drastic increases of urban population.

Cities	Population in millions			
	1980	1990	2000	2010
Tokyo	21.9	25.1	26.4	26.4
New York	15.6	16.1	16.6	17.2
Mexico City	13.9	15.1	18.1	18.7
Paris	8.9	9.3	9.6	9.7
London	7.7	7.7	7.6	-
Bombay	8.1	12.2	18.1	23.6
Karachi	5.0	7.9	11.8	16.8
Lagos	-	7.7	13.4	20.2
Dhaka	-	6.6	12.3	18.4
Cairo	-	-	10.6	12.7

Table 1-1: Some World Urbanization rates from 1980-2010 (Source: UNCHS, 1999)

Related information on these challenges with references to United Nation sources are contained in Devas and Rakodi [1993], Nigel [1992]. Coupled with the problem of growth, developing countries have to reckon with [UNHCS, 2001] :

- High rates of unemployment
- Environmental degradation
- Lack of urban services
- Deterioration of existing infrastructure
- Insecurity of land tenure
- Economic crisis
- Inadequate shelter

In general having acknowledged the challenges of urbanization, the Habitat Agenda was endorsed in Istanbul Turkey, in 1996 to focus on the issues pertaining to provisions of adequate, safer, healthier, habitable, equitable, sustainable and productive shelter for all. In

this regard, the City Development Index (CDI), which is a measure of the average well being and access to urban facilities by the individuals, has been used to monitor the progress of the implementation of this Agenda at the regional, national and city-level.

Nevertheless, the demand for land has escalated continuously, thus causing threat to vacant land within urban areas. However, this goes against the norm of use of the vacant land which states that, *'if the supply of social facilities is to follow demand there is an implied necessity to keep some land undeveloped to accommodate the facilities as they are required'* [Amos, 1993]. But this is hardly the case particularly in developing countries because vacant land is subject to:

- squatting
- irregular allocation
- neglect and derelict that is environmentally offensive especially when used for garbage disposal.

These problems are compounded by:

a) Inaccessibility of current and systematic information to the urban managers and policy makers pertaining to:

- Extent of settlements
- Land use patterns
- Environmental problems
- Infrastructure facilities

This makes it difficult to establish the scale of needs, amount of resources available and to predict growth. Information deficiency gives rise to mismanagement of resources [Furtado, 1991]. A practical approach to address such a problem was for instance, undertaken by the city of Hannover in collaboration with the Ecological Research program, and developed an Environmental Information System which contains data to support effective decisions. Among the many projects supported by this system is the planning of the Expo-Gelände, whereby every building plan was generated with the help of this system [Meyer, 1995].

b) Complex and ambiguous land law system. This aspect can not be overlooked as it has profound implications on urban management and development. In principle it has four main functions [Davey, 1993] :

- defining the system of urban government
- establishing the system of urban planning
- regulating development of urban planning
- delimiting the powers of urban planners and managers.

Consequently, reliable information and legislative powers to implement projects among other things, for effective planning and management of urban resources is of paramount importance. These includes:

- Information about natural resources. However, most of the information exists in unusable format which necessitates organizational restructuring to enable new solutions for data gathering, processing, management and updating to be implemented.
- Clear policies on how land should be utilised and therefore managed.

- Promotion of partnership of the people who have an interest in Land e.g. City planners, Engineers, Architects, Surveyors, Politicians, Civilians.

This will ensure that the framework within which planners and managers operate facilitates them to act strategically, equitably and efficiently [Davey, 1993]. Moreover, verification of zoning laws versus actual land use can be effected as well as optimising the localization of emergency services e.g. fire, security, health, etc. relative to population.

## 1.2 Objectives of the Study

An urban environment can be characterised by two main classes, namely built up areas (developed) which include industrial, residential, commercial, parking areas, etc. and non-built up areas (reserved) e.g. gardens, sports field, green areas, urban agriculture, etc. This categorization is meant to act as a guideline for the extraction and name assignment of the classes. Within the framework of an urban environment, the transition of reserved areas to developed can be attributed to various factors namely, initial status i.e. current use; existing demand for land; infrastructure availability; physical constraints and the implications in overcoming them; zoning controls and limitations; and existing use of neighboring sites.

Generally, planning data, where in this context it refers to future land use maps, building plans, demographic data, etc. has been primarily used for designating areas for development and non-development, whereas remotely sensed data is largely used as a source for land use information. Little has been reported on the integration of these two sets of information for verification of the implementation of the plans, more specifically in detecting unplanned developments as is the case in developing countries. *In this regard, the main objective of the study is to develop a methodology that exploits existing planning data in combination with remotely sensed imagery for the detection and quantification of unplanned developments and subsequently to facilitate monitoring their trends.* The ability to identify and detect unplanned developments is based on multispectral data and planning data, whereas for monitoring their trend, land use drivers namely existing unplanned developments as well as infrastructure and hydrography are employed. The imagery used were namely spatially enhanced to 10m resolution 1995 Landsat TM and 2000 Landsat TM 10m resolution colour aerial photographs taken 1995 and 1998 for Hannover, Expo area, and 1998, spatially enhanced to 10m SPOT XS for Dar-es-salaam, Tanzania.

The specific objectives are:

- Analysis of image features suitable for discriminating between developed and reserved areas within an automatic image interpretation system.
- Detection of unplanned developments using planning data as prior knowledge
- Modelling the trend of unplanned developments based on the existing unplanned development and accessibility to the main infrastructure and hydrology and current remotely sensed data.
- Evaluation of the methodology and its applicability.

## 1.3 Overview of the Methodology

### General Concept

In principle, the methodology consists of four main modules as shown in figure 1-2, namely image interpretation, detection, trend modelling and evaluation. In this study multispectral *image interpretation* is done which results in two aggregated classes namely developed and

reserved. These are then used as inputs in combination with ancillary information for the *detection* of unplanned developments in the detection module, as well as *trend modelling* whereby the detected unplanned developments are also included in the process. Generally, the amount of detail extracted from the remotely sensed data depends on among other factors the spatial resolution of the data which is a function of the sensor resolution and the algorithms employed. In the interpretation of the images different features have been tested within a rule based interpretation scheme, whereby, well known characterization of objects in various features have been exploited. The land use information is then combined with the planning information (infrastructure, socio-economic, demographic, etc) in highlighting areas designated for development and reserved. This is then compared with another interpreted image taken at a later epoch, to establish whether the plan has been adhered to, in which case any developments outside this jurisdiction is assumed to be unplanned. On the other hand, trend modelling involves growth monitoring of the detected unplanned developments based on additional land use drivers e.g. infrastructure, hydrology, elevation, population growth, etc. This information can then be used by planners to establish the tendencies and preferences of such growths thus enabling them to develop mitigation systems that facilitate prioritising areas requiring urgent reaction planning. *Evaluation* is necessary so as to verify the correctness of the outputs obtained from the interpretation, detection and trend modelling modules. This gives an indication of the feasibility of the methodology. Here, the kappa index, polygon-pixel count and visual comparisons have been used for the accuracy assessment.

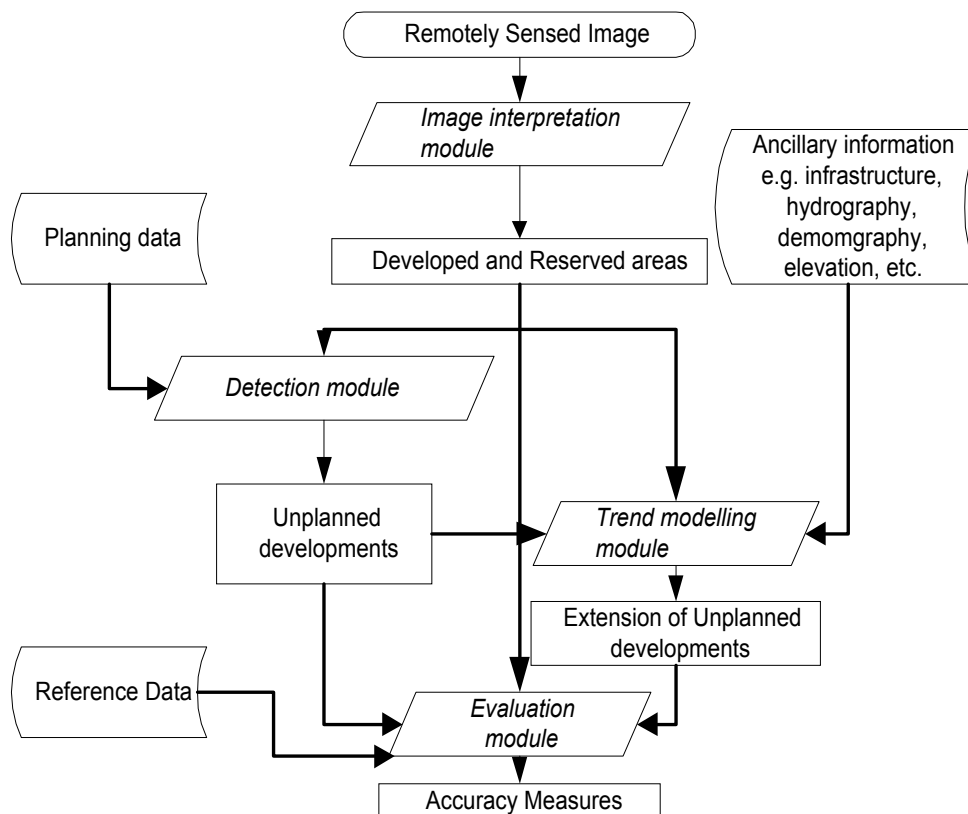

Fig.1-2: Methodology Overview

#### 1.4 Organization of the report

In principle, this report is organized in three fundamental parts, whereby the first part contains chapter 1 as the introduction, and chapter 2 discussing in detail the state of the art in as far as urban form and the role of remote sensing in urban applications are concerned. Part II consists of the theoretical background and is made up of three chapters. Chapter 3 focuses on the interpretation part of the system. A detailed account of the considerations is given with special emphasis on rule based image interpretation paradigm used in this study. Both the detection and trend modelling modules are elucidated in chapter 4. Specifically, how planning data can be exploited in combination with remotely sensed data for the detection of unplanned developments, and further how the extension of the detected unplanned developments is influenced by existing land use. An Assessment of the operationalization of a system is a very important component. The mechanisms for doing this range from simple visualization, to statistical evaluations e.g. pixel-polygon count and kappa index assessment, and these methods are discussed in chapter 5. Part III contains the testing phase and remarks arising from the study. Simulated data for the Hannover EXPO 2000 region is used to test the methodology, specifically the detection of the unplanned developments, whereas Dar-esalaam data is used for trend monitoring. The use of two different data sets for the two main tasks mainly detection and trend modelling was dictated by the availability of data. For instance, in the detection process, two images taken at two different epochs and corresponding planning data were easily obtained for the EXPO 2000 region, on the other hand, data on existing unplanned developments, transport network, hydrography and recent satellite imagery were available, for Dar-esalaam. A detailed account of the processing of these data sets is given in Chapter 6. Summary, conclusions and recommendations arising from this study are enumerated in Chapter 7. Finally, there are the references and the appendix.

*The motivation for this study has been elucidated with emphasis on the prevailing urban planning challenges in the developing countries. In addition, the objectives and an overview of the proposed methodology have been highlighted.*



## CHAPTER 2

### A REVIEW OF URBAN FORM AND ROLE OF REMOTE SENSING FOR DETECTION AND TREND MODELLING OF URBAN DYNAMICS

#### 2.1 Urban Morphology and Growth as Perceived from the Fractal Geometry Paradigm

The ability to visualize city layouts enables planners to have a better understanding of the fundamental order or disorder that has consistently taken place over time. Urban planning is done so as to maintain this order or in the event of disorder attempts are made to alleviate or impose organization. Nevertheless, urban environments present a kaleidoscope of complexity due to the various forces involved namely political, economic, social, and environmental. Hence, the extent to which this order can be imposed depends on how well these forces are balanced or compromised. In general, Batty and Longley [1999] classified cities into those which grow naturally or organically and those which are artificial or planned. Basically the difference revolves around the speed and magnitude (scale) of development which are of course functions of the forces triggering growth. Visually, organic cities tend to exhibit cell growth, whereby growth is predominantly influenced by the existing physical configuration e.g. transport routes, land uses, etc and hence geometrically they appear irregular. On the other hand planned cities consist of smooth curves and straight lines as a result of controls imposed on the use of land, and hence geometrically they are regular. Figures 2-1 and 2-2 show schematic diagrams of typical spontaneous and planned development configurations respectively.

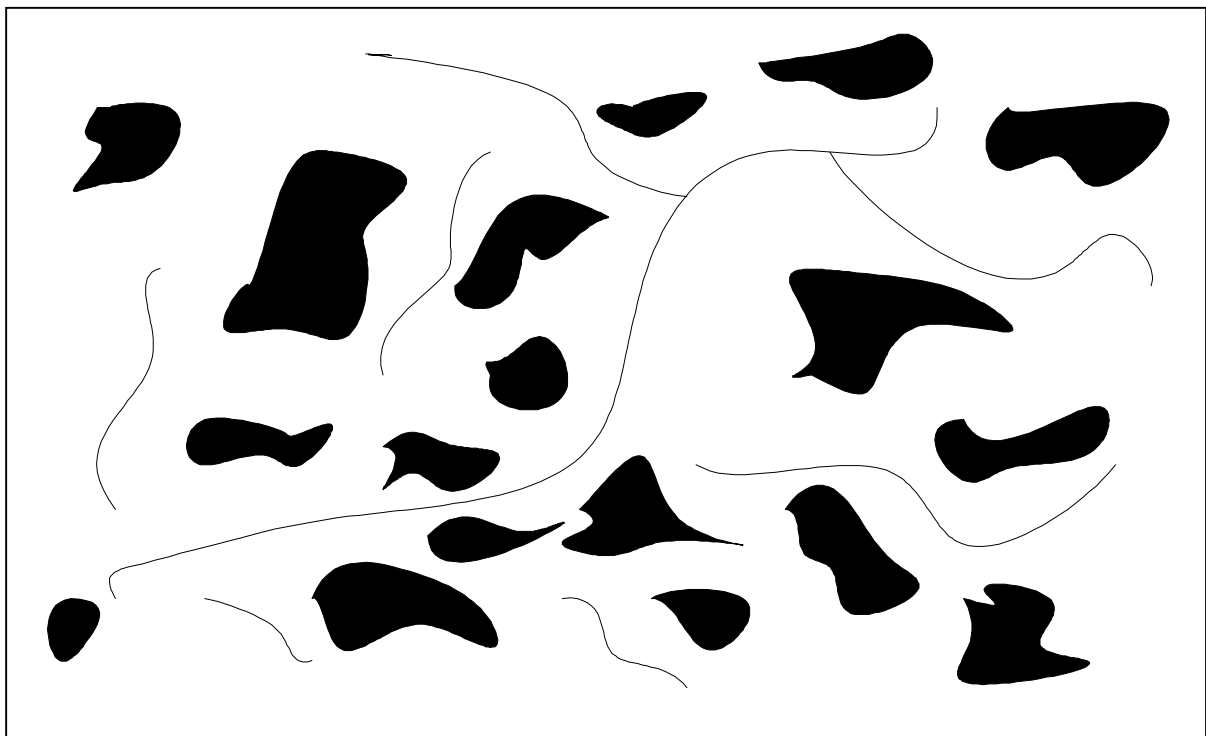

Fig. 2-1: Spontaneous developments

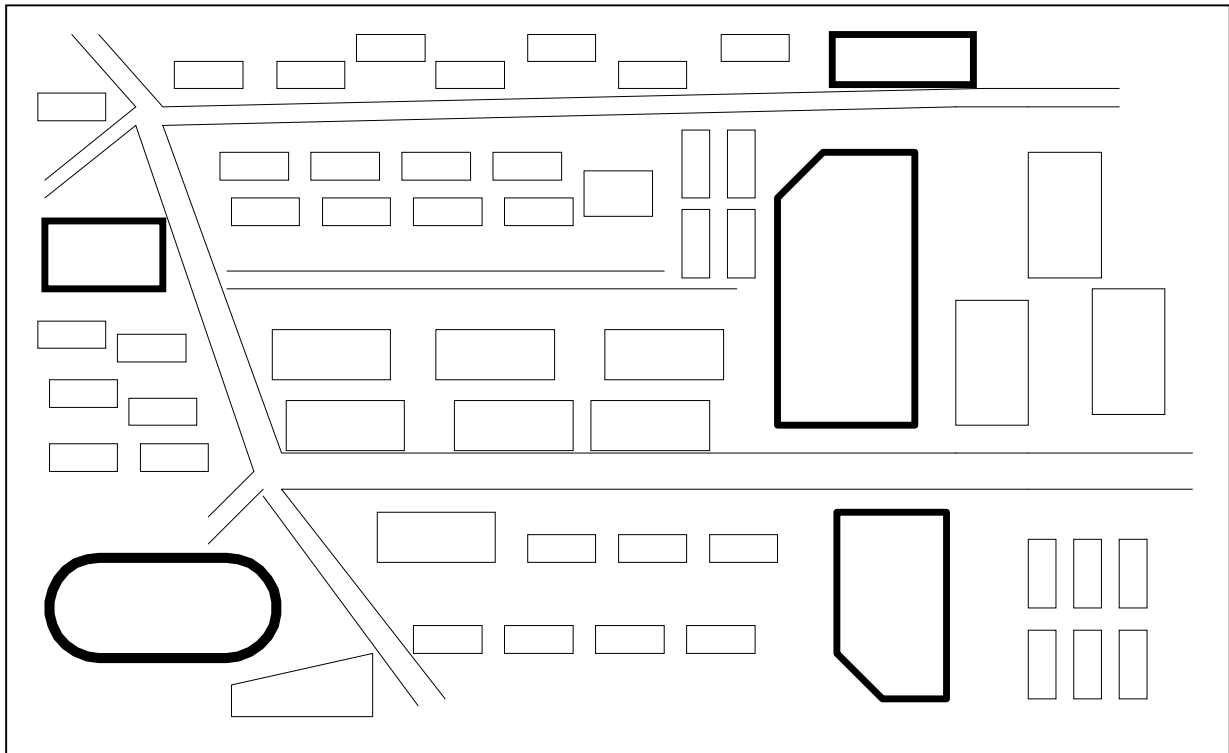

Fig. 2-2: Planned Developments

An urban environment is characterized by different land uses e.g. residential, commercial, recreational areas, parking areas, open spaces, etc. Ideally, the extent of each land use is defined by boundaries. In general, they highlight and distinguish between developed and reserved (non-developed) areas. The details of the uses and cover types depend on the level of abstraction and hence generalization. As cities continue to grow, planners are more concerned with the transitions occurring at the boundaries. Specifically, they seek to find answers pertaining to the causes, types and quantification of these transitions. Clearly, there is an implication of a spatial component in this kind of questions which can be addressed from a remotely sensed and GIS perspective. The next set of challenges include, identifying data sets that are suitable, i.e. the rationale in selecting data e.g. spatial, temporal, spectral as well as availability and affordability, the level of detail required and therefore which methods would adequately address the problem. The next section reviews the role of remote sensing in urban studies, with specific emphasis on the detection and monitoring techniques of developed areas.

## 2.2 Role of Remote Sensing for Urban Studies

The role of remote sensing within the framework of urban studies is three fold [ GTDA, 1995]:

a) Extraction of thematic information for specialized applications: From a mapping point of view, an urban environment can be perceived as a series of diverse themes e.g. transport network, residential, commercial, industrial, hydrology, population density, recreational areas, topography, disaster management, etc. At any one time planners require information pertaining to any or a number of the themes for a particular purpose. Remotely sensed data lends itself to a useful source for such applications. Various studies dealing with the

## A REVIEW OF URBAN FORM AND ROLE OF REMOTE SENSING FOR DETECTION AND TREND MODELLING OF URBAN DYNAMICS

---

extraction of some of these thematic data have been reported e.g. base mapping, Kilston [1996], Konecny [1999], Cauchetier and Thibault, [1995], etc; elevation mapping, Jacobsen [1997], [Westin et al., 1988]; application mapping [Salge and Roos-Josserand, 1988], Chu and Devarajan [1999], Hinz et al., [1999], [Stefan, 2001], Huang and Chiu [1997], Sahar and Krupnik [1997], Zhang [1998], Treitz et al. [1992], etc; disaster management [Kreimer and Zador, 1989], etc

b) Information gap filling through collection of global and previously unavailable data on land use for purposes of strategic planning: This has previously been done in an adhoc manner and based on ground survey methods and aerial photography. Hence, the approach has been project-oriented resulting in some areas being exhaustively mapped whereas others are hardly covered. The proliferation of natural resource sensors implies that even areas which were originally inaccessible can now be mapped. Moreover, the availability of a variety of sensors implies that current data on surface features is now possible for applications requiring up-to-date information. The usefulness of remotely sensed data in this regard has been reported e.g. Manning and Evans [1988], Evans and Fletcher [1991], UMP[1992], Kim et al., [1997], Van Zee and Hayes [1997], [Armenakis and Savopol, 1998], etc. The remote sensing multi-concept has made this possible whereby, four categories can be differentiated namely; multi-stage(different platforms and different altitudes), multi-temporal(different dates/times), multi-sensor(different sensors) and multispectral (different spectral bands) [Clevers, 2000].

c) Dynamic studies of urban phenomena that are time-dependent by combining multi-date and/or multi-source data sets: An urban environment is constantly under transition with new constructions being put up now and then. The rate at which these changes take place can be overwhelming when they have to be monitored by field survey techniques. Remotely sensed data due to its frequency of acquisition can be exploited to alleviate this shortcoming. Planners are increasingly becoming aware, that it is inevitable not to rely on this information source. The potential of remotely sensed data for monitoring changes have been tested and reported in e.g. [Jensen and Ji, 1999, Jensen, et al., 1994, Chen, et al., 2000, Jürgen, 2000, Karanja and Lohmann, 2000, Chan et al., 2001, Yeh and Li, 2001, Dhakal, et al. 2002, etc].

In general, the benefit of using remotely sensed data can be viewed from three perspectives namely:

- Size of study area, which implies that remotely sensed data is able to provide a synoptic perception of the existing town layout which is one of the considerations in strategic planning, thus promoting a better understanding than the available maps which are more often than not outdated.
- Rapid change i.e. less than 1 year, necessitates quick detection so as to facilitate necessary measures to be embarked on and use of remotely sensed imagery saves on the cost and time as well as providing site specific information on natural and man-made features.
- The establishment of urban land databases for GIS can benefit from digital orthophotography which combines both affordability and high accuracy. Moreover, the same GIS database can be used by a cross-section of agencies e.g. for security services, fire, emergency medical services thus spreading cost among more than one user and thereby reducing data redundancy and effort duplication.

The core of this study as already mentioned in section 1.2 is to devise a sustainable technique that employs multispectral and planning data for the detection and monitoring the trend of

unplanned developments. The following section reviews the existing approaches so far in the detection and modeling of change techniques.

### 2.3 Change detection algorithms

Change detection is a technique that is used to highlight conversion of land from one use to another within a given time frame. Within the context of this study, the focus is on changes resulting from reserved to developed, with special emphasis on unplanned developments.

The two most important considerations for change detection are:

- Times of the year, which has an implication on the best time to detect and delineate urban and non-urban features, thus it is environment dependent.
- Number of dates required for the change detection which is dictated by the purpose of the study. Two levels can be identified namely:
  - Two dates which then implies detection of non-urban to urban use and vice versa, although the latter is a rare occurrence.
  - More than two dates whereby the purpose could be the identification of specific stages of development or setting up a historical data base so as to understand and visualize changes or developments over the years, for instance, this is one of the objectives of the MURBANDY Project for the European cities.

Figure 2-3 shows an overview of the existing change detection techniques:

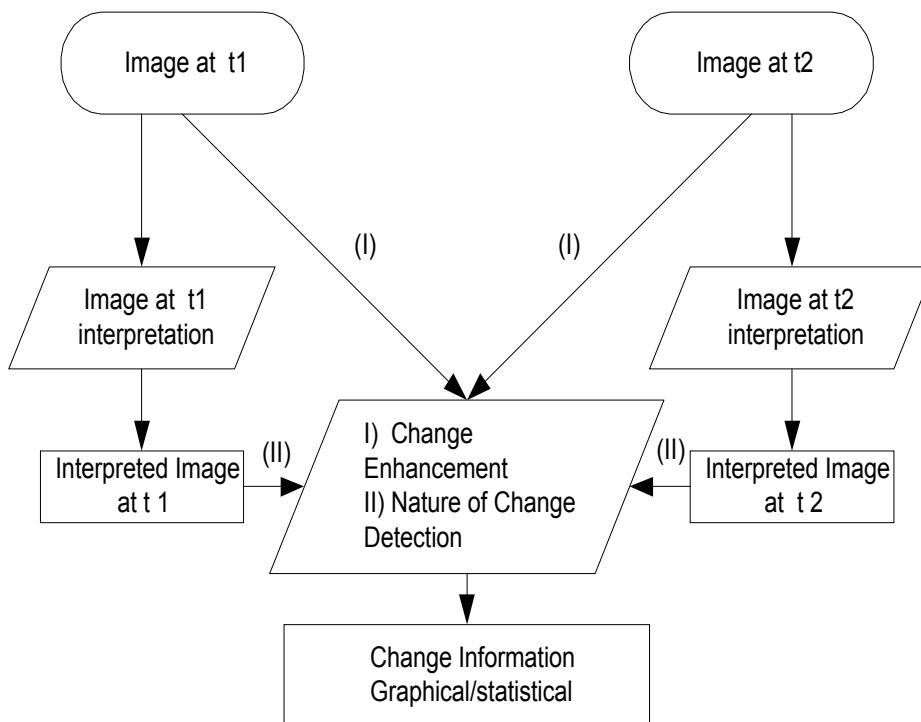

Fig. 2-3: Change Detection Techniques

Different change detection approaches are in existence and they fall into two main categories namely change enhancement and nature of change detection techniques, Chan et al. [2001].

### 2.3.1 Change Enhancement Techniques

These techniques involve direct combination of the raw data sets at pixel level of two images taken at two different epochs i.e. Image at t1 and Image at t2 as shown in figure 2-3. The algorithms include image differencing, ratioing, vector analysis, and principal component analysis. However, they are hampered by the inability to comprehensively address variations in atmospheric and ground conditions, differences in illumination effects and sensor calibration at the two epochs in question as shown in figure 2-4, [Karanja and Lohmann, 2000]. Variations in atmospheric conditions causes changes in the mean and variance of digital data. Shorter wavelengths tend to be attenuated thus resulting in less contrast and hence less information content in comparison to longer wavelengths. Precipitation prior to overpass results in changes in soil moisture content thus variations in radiance between the two epochs. Ideally, near anniversary images should be used for change detection in order to avoid changes due to sun angle effects and vegetation phenology.



Fig. 2-4: Typical Problems of Change Enhancement Techniques

A more complex change detection at pixel level is the direct multi-date change classification. The data source could originate from the same sensor or different sensors. The temporal data set is classified as a single set, i.e. when 6 Landsat TM channels are in use for each epoch, the complete set will consist of 12 channels. The assumption here is that like phenomena i.e.

where no change has taken place will have statistically similar properties as opposed to those where change has taken place which will be characterized by variable statistics, [Serpico and Bruzzone, 1999; Sersland et al., 1995]. The advantage with this method is that the classification is done in one step, however it has proved to be a very complex procedure, particularly in the situation where the data is from different sensor sources. First, it introduces information redundancy when all the bands are used, moreover, when clustering is performed on the data set, labeling of the cluster is a difficult endeavor.

### 2.3.2 Nature of Change Detection Techniques

Some applications require more information pertaining to the type of changes. This involve comparing extracted land use classes at the two epochs i.e. Post Classification Comparisons. The advantage of such change detection techniques is that they avoid the problems encountered at pixel level (see figure 2-4,) through independent classification of the images taken at the two different epochs (Image at t1 and Image at t2 as shown in figure 2-3). Thus the comparison is at higher level of abstraction whereby the pixel contains not only the digital number, but an additional attribute of the land use class assigned through interpretation. Of course, the results depend on the accuracy of the individual classification which in turn depend on the algorithm and the data sets employed [Meinel, et. al., 1997, Macleod and Congalton, 1998, Zenk, 2000, etc]. Specifically, comparison of algorithms in determining the nature of change in an urban environment have been done by [Chan, et. al, 2001]. The following section gives a review of the image analysis algorithms.

#### Image Interpretation Algorithms

The different interpretation algorithms can be grouped into two. First, the statistical pattern recognition e.g. Maximum-likelihood, Mahalonobis distance, Minimum distance, etc. second, image analysis techniques which incorporate high level cognitive approaches. Statistical approaches have proved to be inadequate in dealing with high resolution satellite images and particularly for urban applications due to the heterogeneous nature and variable object sizes which cause spectral signatures to overlap e.g. [Karanja and Lohmann, 2000]. On the other hand, image analysis incorporate different interpretation cues which leads to more robust image interpretation systems. A detailed overview pertaining to the methodologies of pattern recognition, image analysis and knowledge based image interpretation is reported in [Argialas and Harlow, 1990]. The architecture of these knowledge representation schemes namely rules, semantic networks, frames and hybrids are described in [Bondo, 1990, Davis et al, 1993, Tönjes et al, 1999, etc]. The following section briefly highlights the important features of these knowledge representation schemes:

#### Rule Based Systems

- These are also sometimes called production systems. They consist of a knowledge base which comprises data (objects, facts, goals) and rules (condition, action) and an inference engine whose role is to assemble rule instantiations in a conflict set from where one or more rules are selected based on some criteria e.g. recency or specificity. The relationships are represented using the condition-action pairs, thus

IF (condition)

THEN (action)

Where the condition is also referred to as premise, antecedent or Left Hand Side (LHS) and the action, conclusion, consequent or Right Hand Side (RHS).



### Semantic networks

- These are graphical knowledge representations of nodes which represent objects, concepts or events and are linked to each other through arcs which represent relationships between objects. IS-A and IS-PART-OF are the mostly applied links. Like frames, semantic networks allow inheritance of properties from other objects.

### Frames

- These are structural models used to represent groups of attributes that describe a given object, whereby each attribute is stored in a slot which may contain default values, rules or procedures for changing the values attached to the attributes. Information contained in a frame can be either procedural or declarative, or both. A frame is defined by fixing the number of and type of slots.

### Hybrids

- They incorporate the attractive elements e.g. the representation paradigms into a single integrated programming environment.

Various studies employing any or a hybrid of these systems and addressing different areas of application have been reported, e.g. [Mehldau and Schowengerdt, 1990], [Moller-Jensen, 1990], [Schenk and Zilberstein, 1990], [Bolstad and Lillesand, 1992], [Harris and Ventura, 1995], [Koch, et. al., 1997], [Kunz, et. al., 1997], [Tönjes, et al, 1999], etc. Applications of temporal knowledge in the interpretation of satellite imagery has been done e.g.[Middelkoop and Janssen, 1991], [Wang, 1993], [Growe, 2000], Pakzad [2001], etc.

Such systems in principle incorporate knowledge about the objects of concern within the image data and are represented within the knowledge base. In addition, map or GIS data (e.g. with limited accuracy and currentness) is in most cases available giving an indication of the location of specific objects and serving as an initial symbolic scene description, thus forming a hypothesis about the objects suspected within the image to be interpreted. This hypothesis is tested against current image data and returns features, based on interpretation rules and a reliability measure. Within the interpretation, these features and their relationships are grouped and the hypothesis having the highest confidence value is selected, where confidence values are preset. Whereas conventional satellite image analysis techniques are restricted to pixel based classification the new approaches, employ a model-driven top-down approach together with a data-driven bottom-up process of image analysis.

The comparison of the interpreted images can be done either manually e.g. by visually identifying similar areas and any changes thereof, or automatically e.g. using post classification change algorithms [Thiam, 2000]. The results of the comparison depend on the accuracy of the individual classifications. This is particularly critical when dealing with urban environments where heterogeneity is more or less the norm as the exception.

### 2.3.3 Technical Aspects of Remote Sensing for Urban Studies

Change detection and monitoring involves integration of data from different sources, with varying resolutions in terms of radiometry, spectral, geometry and temporal. Consequently,

## A REVIEW OF URBAN FORM AND ROLE OF REMOTE SENSING FOR DETECTION AND TREND MODELLING OF URBAN DYNAMICS

---

the final output is influenced by these characteristics and therefore prior understanding eventually facilitates in the evaluation of the output.

### Radiometric aspects of remote sensing data for urban dynamics

Generally urban objects are complex in nature, which makes it impossible to establish a direct relationship between one real object and the radiometric values. Pixel values may belong to either homogeneous objects or heterogeneous ones in an urban environment the later is frequently encountered. The main radiometric sensor errors are due to stripping which introduce noise in the pixels of the scanned lines and hence corrections which adjust the brightness values of the noisy pixels or missing pixels are an important consideration prior to processing. The atmospheric conditions during the imaging process which contain vapor and the aerosol introduces noise in the digital numbers. Atmospheric corrections can be applied in an attempt to alleviate these occurrences. Sun illumination is especially critical in mountainous regions. Slope characteristics i.e. aspect and steepness can be computed from a DEM and used to correct this effect. This is especially critical when change detection is done at pixel level e.g. band-ratios, etc. Typical problems are as highlighted in figure 2-4.

### Spectral aspects of remote sensing data for urban dynamics

This point refers to the particular wavelengths in the electromagnetic spectrum detected by a sensor. The number of bands or channels is also used to describe how many distinct wavelength intervals a particular system, e.g. SPOT XS is a three band image whereas Landsat TM has seven bands. A distinction is made between coarse resolution which refers to a broad interval of electromagnetic spectrum recordable by a sensor e.g. a range of 0.51-0.73 $\mu\text{m}$  for SPOT panchromatic as opposed to e.g. band 3 of the Landsat TM sensor with a fine spectral resolution whose range is 0.63-0.69 $\mu\text{m}$ . It should be noted however, that the spectral characteristics of an urban object is dependent on the incident radiant flux on the object, the geometric relationships between the incident energy and sensor angle-of-view, atmospheric conditions, and on the physical properties of the feature.

### Geometric aspects of remote sensing data for urban dynamics

The geometric characteristics of objects is a function of image resolution and object type. Integration of different data types having different scales, spatial resolutions, etc for change detection and monitoring necessitates that the features on the raster and vector data represent the same objects on the ground i.e. in terms of location and orientation to avoid artifacts and spurious areas of change between the two data sets. The spatial resolution and scale are not synonymous i.e. the spatial resolution of an image is the same throughout, whereas the same image can be represented at different scales. On the other hand, the Instantaneous Field Of View (IFOV) is also sometimes used to describe spatial resolution. However, this is not always the same as the area represented by each pixel due to overlap during scanning. Nevertheless, the detectability of an object does not only depend on the spatial resolution of the sensor but also on the characteristics of the object e.g. material type and its surrounding. Hence, geo-referencing or geo-coding should be conducted at a sub-pixel accuracy. Methods here include rubber sheeting, transformation and resampling based on control or tie points, and automatic co-registration based on the intensities of both images.



### Temporal aspects of remote sensing data for urban dynamics

Within an urban context, the temporal resolution can be perceived from 3 main aspects namely:

- The phenomena under investigation and its general trend (Rate of Change of the phenomena) whereby in this study the focus is on urban land use. This in turn determines the rate of demand of information by urban planners and managers.(e.g. monthly, yearly, etc).
- Availability of remotely sensed data for urban studies i.e. frequency of coverage, and its usefulness (Rate of data acquisition i.e. a sensor system must have a systematic period between coverages e.g. 18 days, 26days, etc. and records the same geographic area at the same time of the day to minimize diurnal sun angle effects.

This knowledge forms the basis for project design, i.e. well understood phenomena and the necessity for the planners to monitor it. With this background, the appropriate source of information is established and the data acquired and processed.

The two most important considerations in the context of monitoring change are the temporal and the spatial aspects of objects. Indeed identified four possible combinations which eventually determine the spatial and temporal level of objects are reported in Nigam [2001] namely:

- Rapid dynamic of large objects would necessitate low spatial resolution and high temporal information.
- Rapid dynamic of small objects on the other hand would require a combination of both high spatial and temporal resolutions.
- Slow variations of large objects will need both low temporal and spatial resolutions.
- Slow changes of small objects would require high spatial resolution but low temporal resolution.

In general, the choice of change detection technique depend primarily on the application. For instance, if the task is to detect whether changes have occurred with disregard to specifics e.g. which land use is converted to which land use, then change enhancement techniques would be adequate for the purpose. On the other hand as the demand of details or information and accuracy rises then nature of change techniques can be considered where each image is treated independently and the algorithms for the interpretation vary in complexity ranging from statistical multispectral image classification e.g. maximum likelihood to knowledge based systems. In this study, the objective is more than enhancing change, i.e. the conversion of reserved areas to developed areas but also to affirm that the detected change is due to unplanned developments. In this regard, additional information pertaining to the type of permitted land uses is required. This is due to the fact that the decision as to whether residential is formal or informal or in general a developed area is planned or unplanned is fundamentally a legal issue. This is realized by strategic planning which involves modeling where appropriate planning drivers are incorporated. The following section gives a review of the planning models in use.

### 2.4 Review of Urban Prediction Models

In general, models are estimation techniques which are used to point out some trend of a

phenomena. The quality of this trend should be understood within the framework of the assumptions or criteria adopted, quality of the data and simulation mode or equations. Figure 2-5 shows the four types of planning models namely Land-Use, Transportation, Economical, and Environmental Impact [U.S. EPA, 2000] whereby:

- The Land-Use models predict changes in land use by incorporating a variety of land use categories e.g. commercial, industrial, parks, forest, etc. These models will differ in complexity in terms of computing power, detail, technical use, and visualization capabilities.
- Transportation models are used to support decisions on future travel patterns by employing variables like mode of transport, number of trips, traffic routes including starting and destination points.
- Economic models predict incomes, employment opportunities, inflation rates, etc.
- Environmental impact models are used to assess the effects of natural and artificial phenomena on the different aspects of the environment, e.g. water and air pollution, wildlife, floral and fauna, etc.

Although, these models have been thus categorized, it is not uncommon to find some elements from one model being incorporated into another model. For, instance in this study the main concern is in urban land use, whereby transportation network is a core component, the economic trend has an impact on the urban growth, whereas urban land use has an impact on the environment.

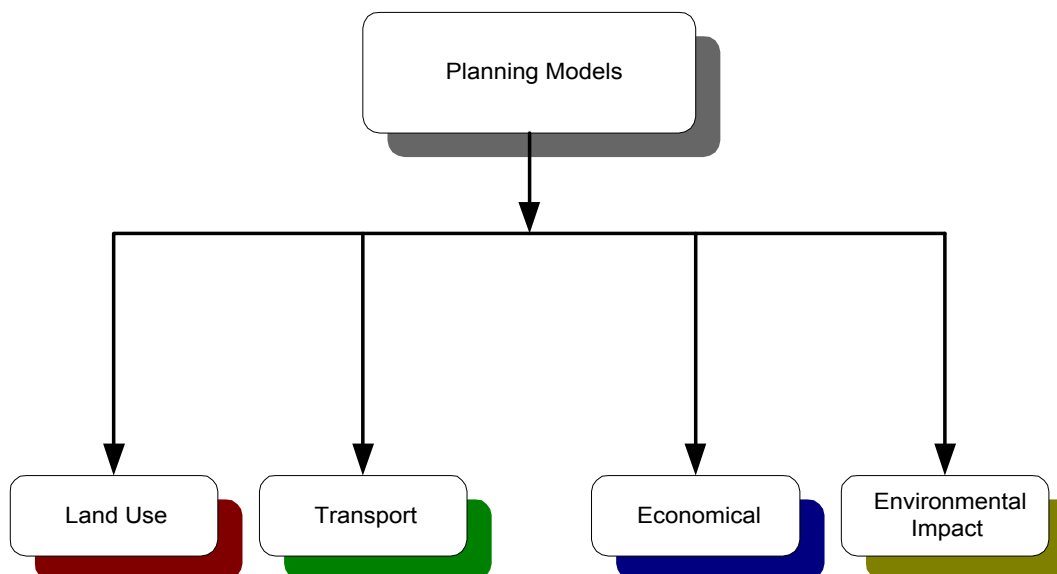

Fig. 2-5: Planning Models

These models predict land use on a long term basis. For instance, changes between categories have been modeled using logistic or logit model. Two types of this model exist namely the binomial (two change possibilities) and multinomial (more than two change possibilities), [Landis and Zhang, 1997]. The land transformation model makes use of relative land transition probabilities generated by calculating drivers of land use change and cells under consideration [Pijanowski, et al., 1997]. A variation of this model is where land is zoned based on environmental indicators for purposes of locating specific sites e.g. industries. Such a study has been carried out in India using what they called the zoning atlas [Chaturvedi,

2001]. The Cellular Automata paradigm whose unit of analysis is a cell, models change on the basis of two assumptions the initial status and the spatial context [Clarke,1997]. The MURBANDY project for European cities employ this technique. Markov models employ empirical data to characterize existing change both spatially and temporally. Results obtained from all such models could be checked using the Join-Count statistics which takes into account the joins between adjacent polygons or by means of other spatial attributes e.g. mean patch size, edge density, etc in Landscape Metrics [Wood, et al. 1997]. Two issues arise from the afore discussion:

- All these models attempt to predict long term land use changes. The underlying disadvantage with these models is that they require many observations to be statistically stable and moreover they are hampered by the inability to comprehensively model all the contributing factors to change. These factors have been summarized by Sui [1997].
- On the other hand, in order to execute reaction planning effectively, short term as opposed to long term modeling would be preferable. The implication here is that, there is need to understand the tendencies of such growths with respect to their origin, existing infrastructure, hydrology, demography, etc, once new developments have been detected. Specifically, an assessment of which of the new developments are likely to be an extension of unplanned developments. Consequently, this forms the backdrop of trend modeling of unplanned developments in this study.

## 2.5 Sought System Functionalities

The system to be developed should be able to:

- Automatically discriminate between developed and reserved areas from multispectral imagery, by incorporating different interpretation cues e.g. context, spatial, spectral, etc. These are used as inputs both in the detection and trend modeling of the unplanned developments (see figure 1-2).
- The ability to employ domain specific knowledge i.e. rule of thumb, as a consequence of experience gained through experimentation thus making it easier to express this knowledge as heuristic rules.
- Ease of modeling by incorporating different criteria, e.g. in trend modeling.
- Once the knowledge base has been established, the possibility of transferability maybe with slight tailoring.
- Facilitate checking of the results (i.e. Justification of the outputs) obtained so as to enable adjustments to be made if need be.

Any one of the knowledge based system already elucidated namely rules, semantic networks, frames and hybrids can be used for this purpose. In this study, however, the rule based scheme was selected due to the fact that only a limited set of rules based on four image interpretation cues are desired to be tested. Thus the rapid prototyping is meant specifically to address the following queries namely:

- The suitability for the discrimination between developed and reserved areas for purposes of detecting unplanned developments and subsequent monitoring of their trends.
- The degree and ease of automation possible.
- The degree of transferability of such knowledge base once established.

## A REVIEW OF URBAN FORM AND ROLE OF REMOTE SENSING FOR DETECTION AND TREND MODELLING OF URBAN DYNAMICS

---

The Erdas Expert Classifier was employed in this study [Erdas Imagine 8.4, 1999]. Some of the remarkable features of this system are:

- Interactive environment for development and testing thus facilitating repetitive evaluations.
- Access to external packages e.g. for graphical modeling, programming, graphic display capabilities in an interactive mode.

*The focus here has been the review of the status of the art in as far as use of remote sensing techniques in combination with ancillary information for urban applications is concerned. Specifically information extraction techniques, detection and prediction of urban growth have been reviewed.*

## **PART II: THEORETICAL CONCEPT**

## CHAPTER 3

### IMAGE INTERPRETATION MODULE

#### 3.1 Overview

This chapter gives a detailed account of the image interpretation module adopted in this study. It basically involves knowledge acquisition, representation and interpretation. Figure 3-1 highlights this module within the proposed system.

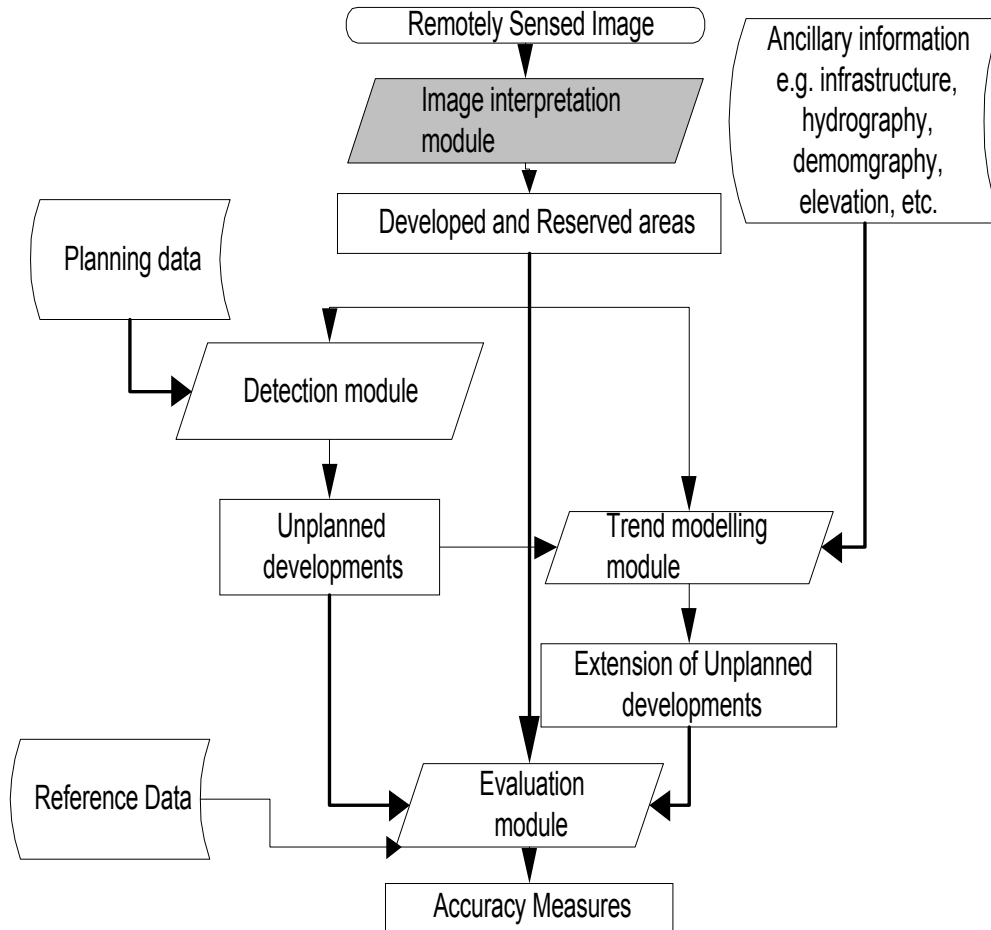

Fig. 3-1: Image Interpretation Module

Figure 3-2 elucidates the processes involved from the raw image at pixel level to the final informational output classes. Knowledge acquisition entails feature extraction and labeling, which are in turn used as inputs in the knowledge base interpretation with the help of the rule system, namely the IF(condition) THEN (action) pair. Collateral data facilitates in the labeling of the objects. The determination of the output class or Hypotheses is basically dependent on two main criteria namely confidence value or level of priority e.g. recency. Developed and reserved areas are the desired final results in this study and hence this necessitates another level of class aggregation.

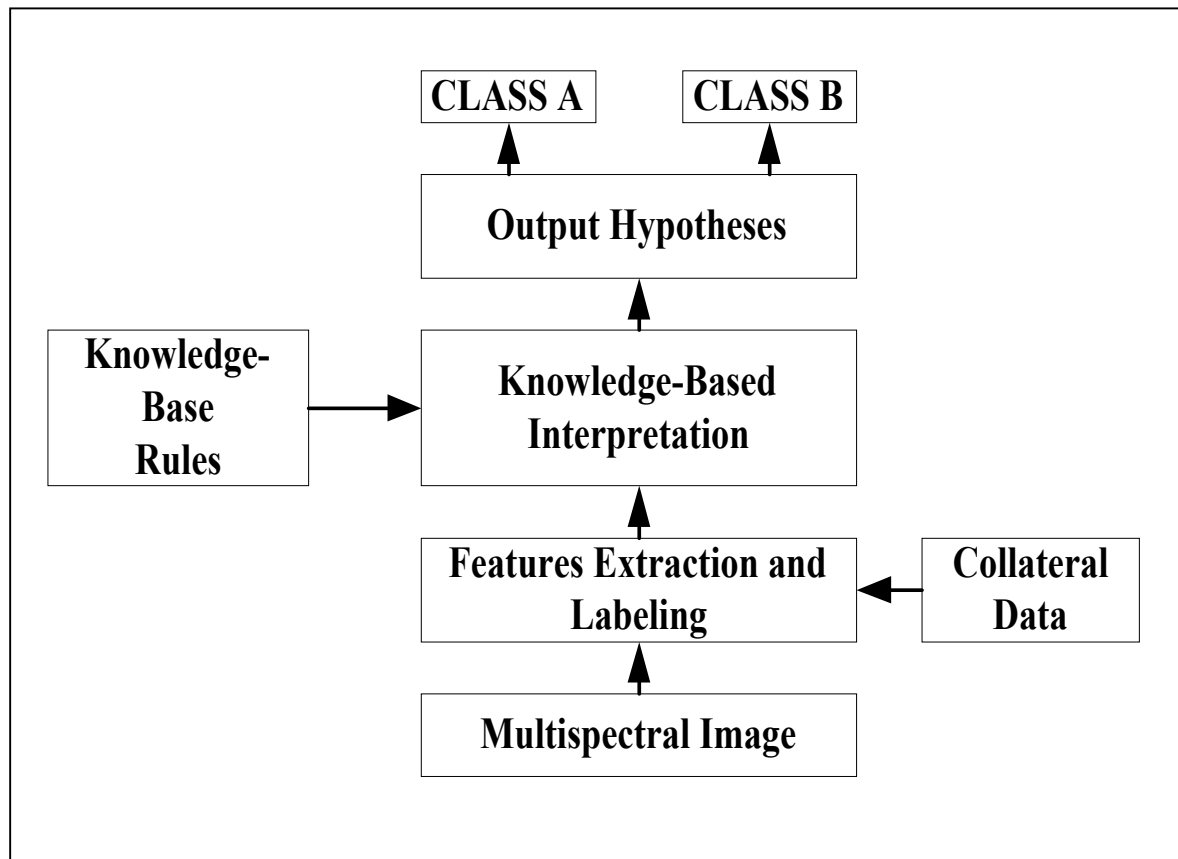

Fig. 3-2: Components of the Image Interpretation Module

### 3.2 Features Extraction and Labeling

The fundamental requirement in automatic image interpretation within a knowledge based environment is the characterization of the real world objects found within the scene whereby in this study the classes of interest are developed and reserved areas. In general, this entails transforming a raw digital image into one which has a better signal-to-noise ratio or other desirable properties by enhancing an image to emphasize the details of interest.

Figure 3-3 shows some examples adopted for the two classes i.e. developed and reserved as defined in section 1-2 ( whereby developed areas include among others industrial, residential, commercial, parking areas, etc whereas reserved areas consist of gardens, sports field, green areas, urban agriculture, etc. Details of the choice of image interpretation keys have been reviewed e.g. by Kelly et al. [1999]. The illustrations were obtained from a Hannover 1995 colour aerial photograph, where transport network, residential areas, industrial areas, parking areas, construction sites and commercial areas are examples of developed areas, whereas agricultural area1, agricultural area 2, agricultural area 3, agricultural area 4, forest, open area, urban agriculture correspond to reserved areas.

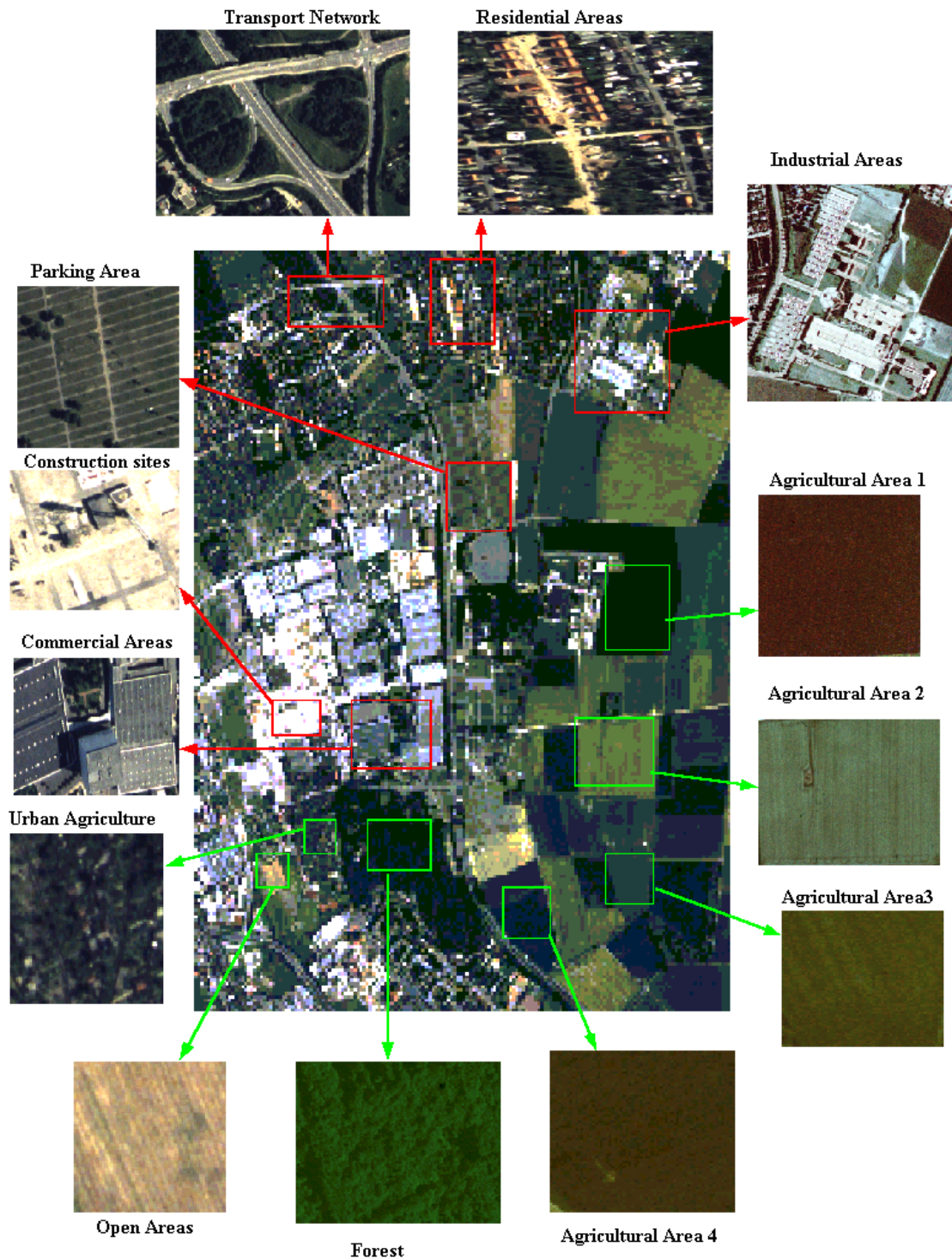

Fig. 3-3: Interpretation Key Showing Class Examples

Features extraction and labeling is application and data dependent, and hence in the context of this study, the criteria of feature selection is dictated by the ability to discriminate between the developed and reserved areas.



### 3.2.1 Features Extraction

In this study the selection of the features was based on their ability to distinguish between developed and reserved areas. In general, this involves segmentation based on local properties (i.e. neighborhood operators and uniformity of gray level). The algorithms include texture, shape analysis, region growing, boundary detection, histogram thresholding, probabilistic relaxation and multispectral classification. The choice of the segmentation method depends on the problem under investigation. The following section expounds on the features that exhibit these characteristics and investigated in this study.

#### Texture

This is a qualitative measure which segments an image into homogeneous structural areas having different characteristics as depicted in the image e.g. roughness, contrast, density, orientation, frequency, repetitiveness. Generally, built and non-built up areas exhibit different textural characteristics, whereby the former are predominantly heterogeneous.<sup>2</sup>In this study the second order (variance) operator was employed. The aim was to ensure that meaningful classes are captured within a homogeneous segment. This is determined essentially by algorithm (operator) and the kernel size, which also has an effect on the computational demands, i.e. as the kernel size increases the more computational intensive it is. Moreover, the spatial resolution should also be a consideration. These two important points are elucidated by the following figures i.e. (i) figures 3-4a through to 3-4c show the effect of increasing the neighborhood sizes from 3 x 3; to 31 x 31; and to 61 x 61 respectively on a section of SPOT panchromatic image of Dar-esalaam figure 3-4, whereas (ii) figures 3-5a through to 3-5c show the effect of improved spatial resolution on an 1m aerial image of Hannover Expo Area.

(i) Effect of varying neighborhood size on 10m spatial resolution data.

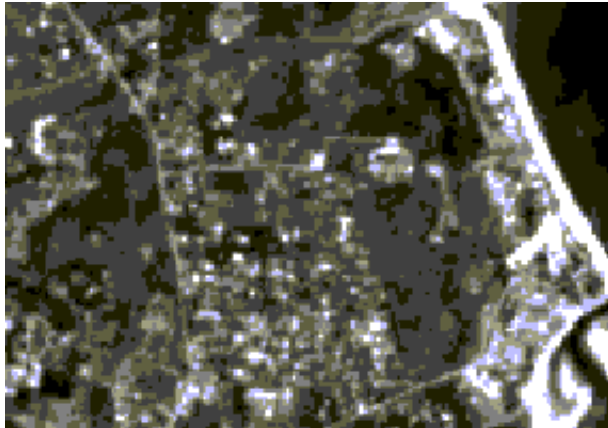

Fig. 3-4: Original 10m Spot panchromatic image of Dar-esalaam

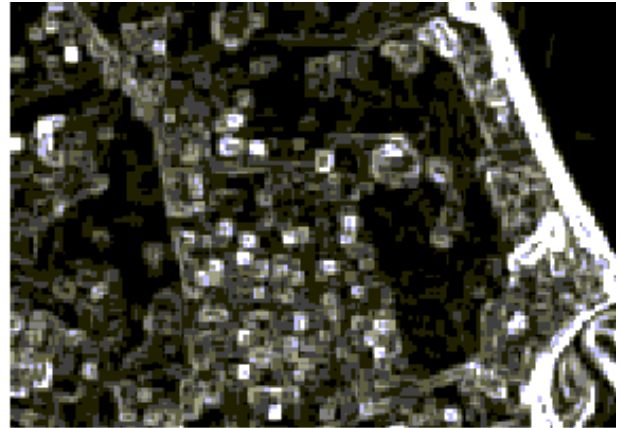

Fig. 3-4a: 3 x 3, texture

<sup>2</sup> Due to lack of a common texture definition various categorization of texture operators exist in literature. For instance Van Gool et al [1985] categorized texture based on the pattern i.e. deterministic or stochastic, whereas texture analysis approaches are summarized as being either statistical or structural, where the former are commonly used. Various parameters are used to describe textures which include mean gray value, local variance, local orientation of the gray value structure, characteristic scale of the gray value structure, variance of local orientation, variance of the characteristic scale. The texture parameters can be grouped into two classes, namely rotation and scale invariant and variant texture features, whereby the former is applicable in situations where the main interest is in the object and not its scale and orientation in space, whereas the latter is suitable where the orientation is important in the reconstruction of a 3-D scene from a 2-D image.

Figure 3-4 is the original SPOT panchromatic image of Dar-esalaam, where in general the very bright areas represent developed areas whereas the dark ones reserved areas. Subjecting this image to a texture operation with kernel size 3 x 3 results in the image shown in figure 3-4a. Here, it is evident the structural information which is not evident in the original image is enhanced.

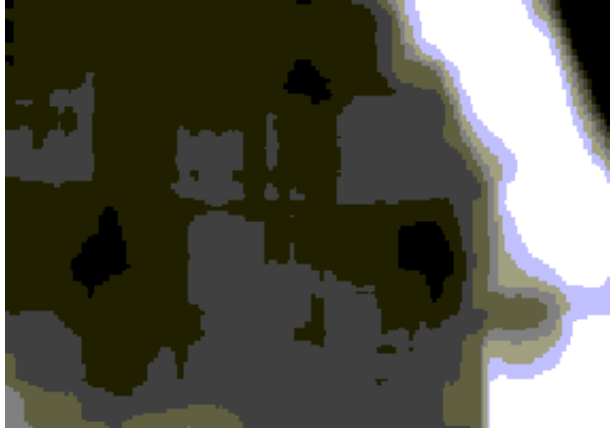

Fig. 3-4b: 31 x 31, texture

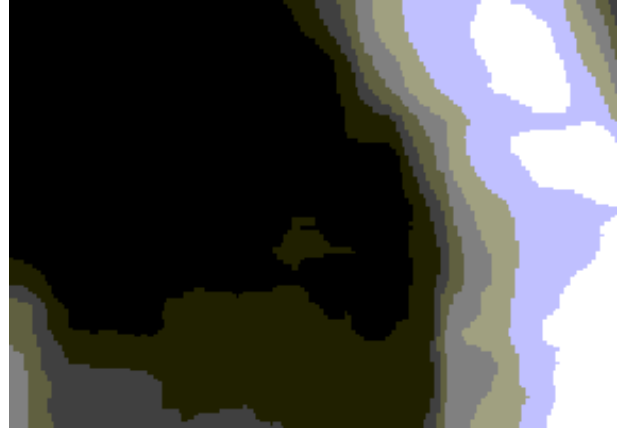

Fig. 3-4c: 61 x 61, texture

Further the effect of increasing the neighborhood on the section of the SPOT panchromatic image with kernel sizes 31 x 31 and 61 x 61 are shown in figures 3-4b and 3-4c respectively. There is more generalization where small areas are suppressed at the expense of large areas with high contrast. Thus in urban areas, which are by nature heterogeneous, there is a trade off between the kernel size and the urban objects, especially when dealing with more than 10m resolution data as in this study.

(ii) Effect of varying neighborhood size on 1m spatial resolution data.

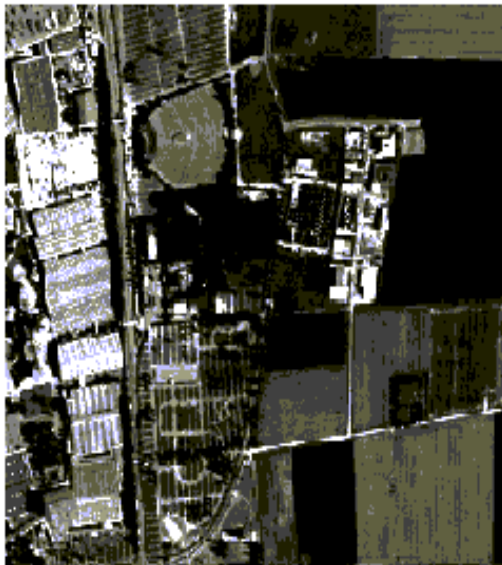

Fig. 3-5: Original 1m aerial image of Hannover Expo Region

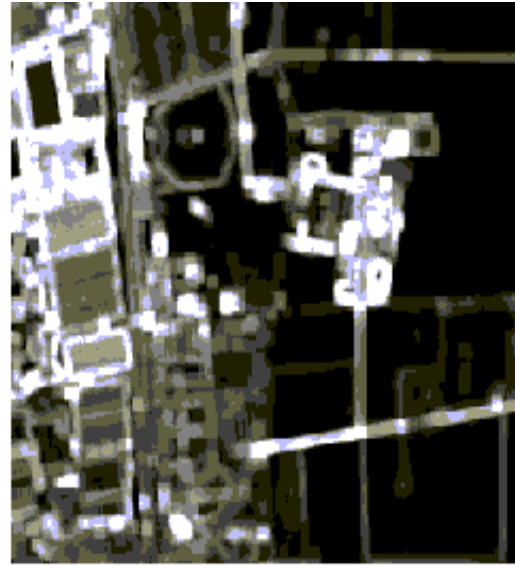

Fig. 3-5a: 3 x 3, texture

Figure 3-5 shows a section of Hannover Expo Region aerial with a spatial resolution of 1m. The bright areas are developed areas whereas the dull ones are mainly reserved areas. The high level of detail presents problems in the enhancement of some urban objects, for instance the roofs of buildings are not homogeneous, they contain patterns whose contrasts varies significantly. Figure 3-5a, shows the 3 x 3 texture image, where to some extent some urban details are well enhanced, i.e. the bright ones, whereas some are suppressed.

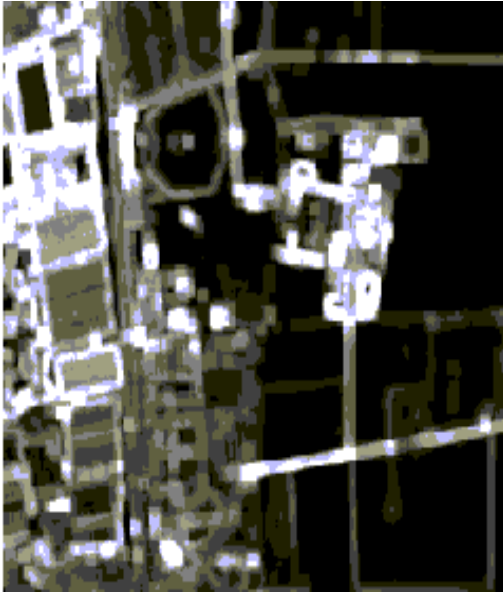

Fig. 3-5b: 31 x 31, texture

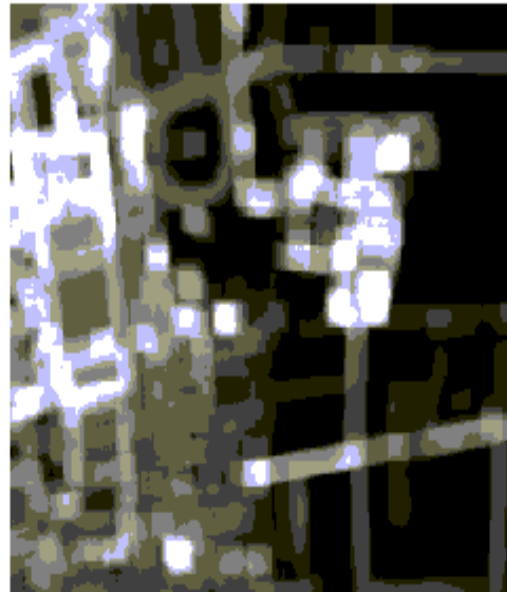

Fig. 3-5c: 61 x 61, texture

Increasing the neighborhood as shown in figures 3-5b and 3-5c clearly indicate that some fine details which were evident on the original image tend to diminish. Similarly, use of texture features is a trade off between the object size and the neighborhood. Although, in principle they do give an indication of developed and reserved areas, precaution must be exercised in interpreting them.

In general, since texture is a variation of brightness in a specified region, it has been shown that it varies as the region size varies, regardless of the resolution as shown in the examples above. Consequently, within the scope of this study, the choice of which neighborhood to use is dictated by the ability to distinguish between developed and reserved areas. However, although texture may uniquely define any of these two objects, it is unlikely to find it working globally for the whole image. Nevertheless, it can be used in combination with other interpretation cues discussed here to generate the best explanation for a particular class, i.e. whether developed or reserved.

#### Edge density

Urban features are essentially high frequency components, and enhancing them facilitates in their discrimination from other low frequency components. Digital filters which operate both in spatial and frequency domain have been used extensively for enhancement purposes. In this study, the focus has been, the employment of a linear filter that operates in the spatial domain, namely the high pass filter, for purposes of discriminating between developed and reserved areas. The coefficients of the filter used are:-

$$\begin{bmatrix} -1 & -1 & -1 \\ -1 & 9 & -1 \\ -1 & -1 & -1 \end{bmatrix}$$

The sum of the coefficients is one which has the effect of sharpening edges while at the same time preserving the average intensity of the original image.

High pass filter was investigated due to the fact that it is capable of enhancing high frequency components e.g. urban features, boundaries thus facilitating in their discrimination. The extent to which these components are highlighted is a function of the filter size and type as well as the data in use. The following example (fig. 3-6) shows a section of the Dar-esalaam SPOT Panchromatic image after subjecting it to a high pass filter. The bright areas have a strong response to the filter and represent predominantly built up areas, whereas the dull ones non-built areas, which correspond to high gray values and low ones respectively

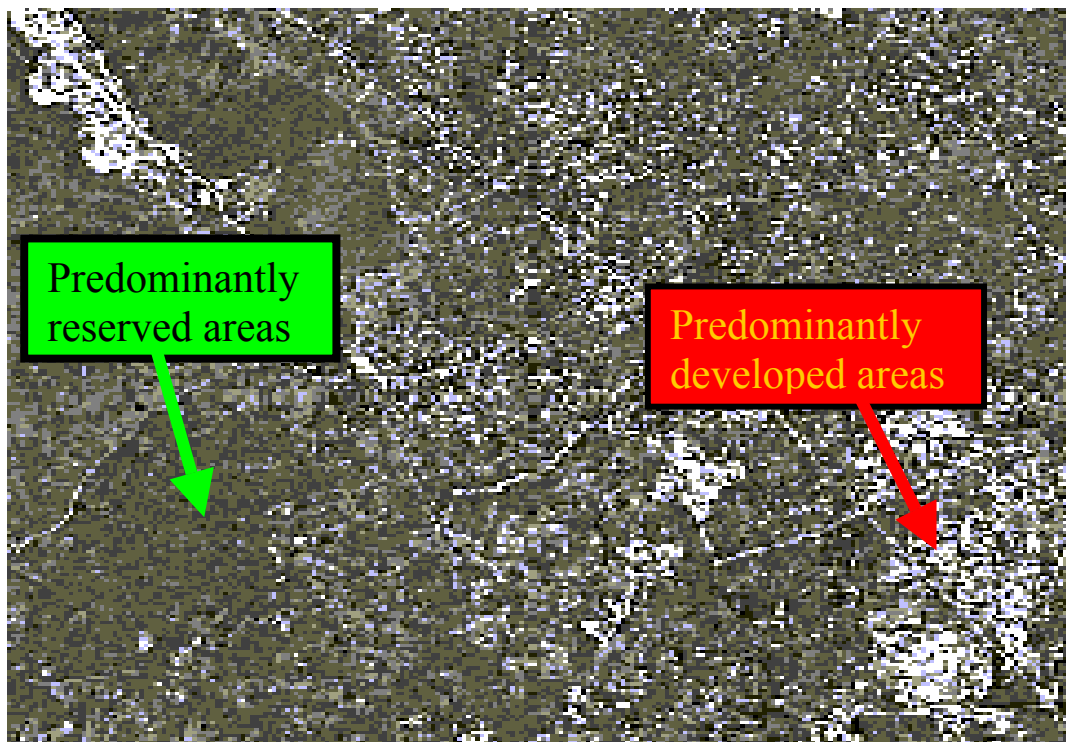

Fig. 3-6: Edge density Image

## Indices

The mathematical combination of DN values of different bands generates indices which in principle highlight or enhance subtle features which would otherwise not be appreciated when displayed in the original colour bands. The operators mainly employed include addition, subtraction and ratioing. One of the commonly used indices for the discrimination between vegetated and non-vegetated areas is the vegetation index. Within the framework of this study, it was deemed necessary to investigate it due to the fact that, it's a good indicator of sealed and unsealed areas. In addition to the normalized difference vegetation index that was employed in this

study, other indices are namely simple vegetation ratio, normalized index or a transformed normalized vegetation index. An example of an NDVI image is shown in figure 3-7 for a section of SPOT multispectral image for Dar-esalaam, Tanzania, with areas which are predominantly developed and reserved highlighted which correspond to dark areas (low NDVI) and bright areas (high NDVI) respectively.

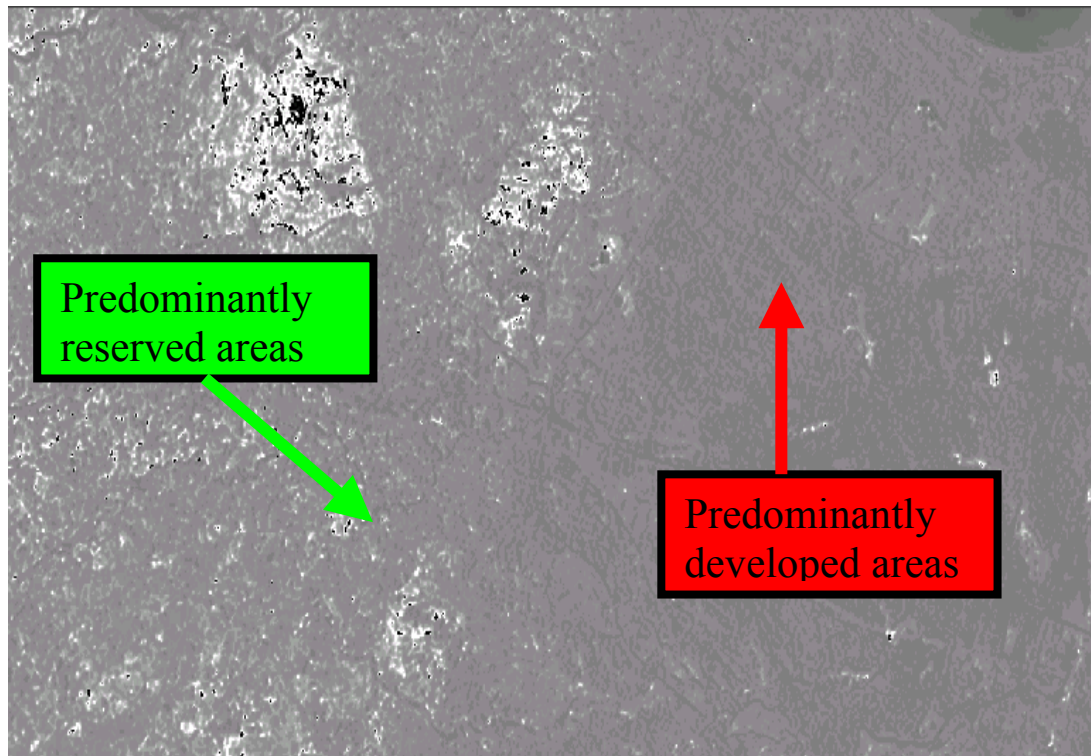

Fig. 3-7: NDVI image

### Spectral information

Clustering of a scene for pattern recognition purposes using unsupervised techniques is done essentially due to two reasons, 1) absence of prior knowledge about the classes within a scene, i.e. lack of ground truth data; 2) features within the scene are not well defined. Pixels are grouped into spectral classes numerically with little influence from the analyst. The resulting clusters can be used as a guide in the selection of training areas as reported in some studies e.g. Chuvieco and Congalton [1988]. Nevertheless, these spectral classes must be converted into information classes a posteriori.<sup>3</sup> ISODATA [Erdas Imagine 8.4, 1999] classification which was employed in this study, is similar in principal to the K means method but incorporates procedures for splitting, combining, and discarding trial classes. These classes must be interpreted against some ground truth information in order to assign meaningful classes. However,

<sup>3</sup> There are different algorithms which employ different criteria and therefore differ in the efficiency. Some of the frequently used algorithms include; simple one pass clustering where pixels are assigned to the nearest class center in one processing pass. It is a very fast classification method. On the other hand Fuzzy C Means classification, determines a membership grade for each class for every pixel which is in turn used to refine the membership for every iteration, until the limit is reached. K means classification is normally faster than fuzzy and pixels are classified based on nearest class center and refinement is done in every iteration. This process stops when the Maximum Movement for Steadiness parameter value and the Minimum Steady Cluster percentage are fulfilled



as shown in figure 3-8 which is a section of SPOT XS for Dar-esalaam clustered image, with 9 classes, some classes are meaningful whereas others are not.

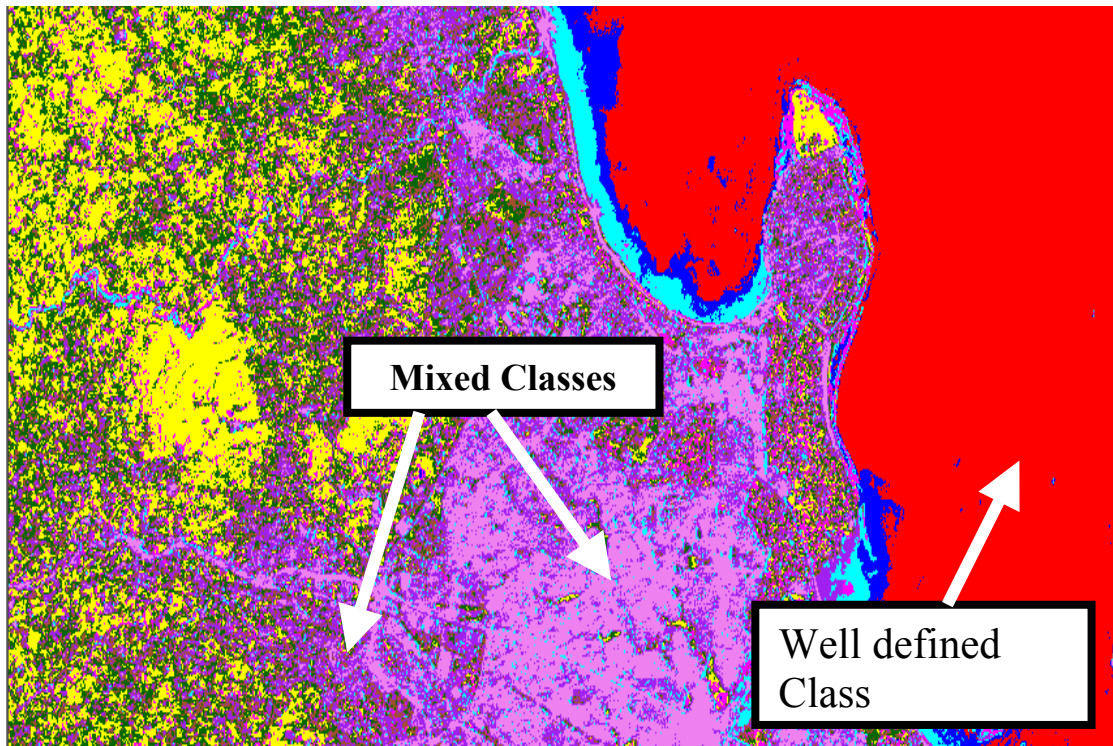

Fig. 3-8: Clustered Image

### 3.2.2 Features Labeling

The labeling of regions resulting from the segmentation processes is also application dependent. The idea is to assign regions to meaningful classes that correspond to the scene and are also useful for the application. For instance, in this study thresholding based on some attributes e.g. aims at discriminating between developed and reserved areas. Although, this method is very easily implemented, its success depends on the separability of the gray level bands as well as the spatial distribution of the gray levels [Schenk, 1999].

Two scenarios can be identified here namely, a straight forward case in which the clusters can be distinctly separated and a complex case whereby either the gray levels occur with the same frequency or they are distinct but do not correspond to meaningful classes. This necessitates stepwise thresholding incorporating domain knowledge about the scene.

The labeling of the regions can also be done either automatically or interactively. For instance in the case of assigning classes resulting from unsupervised classification, this requires an interactive labeling. On the other hand automatic labeling of objects can be realized by means of simple condition rule e.g. regions

IF (A, B, E); THEN Pixel Class<sub>RC</sub> = 1; ELSE Pixel Class<sub>RC</sub> = 2.

The effect of this simple statement results in the three regions labeled A, B, and E being assigned to a Pixel Class<sub>RC</sub> referred to as 1 whereas any other will belong to Pixel Class<sub>RC</sub> 2. This is also referred to as recoding abbreviated as RC in this study and is useful especially in the generalization or aggregation of information.

Automatic thresholding (abbreviated as THR for the purpose this study) based on histograms is the easiest method, whereby different thresholds are tested until a suitable one is obtained with respect to the problem under investigation. For instance, it is well known that low NDVI values represent sealed areas whereas high NDVI values non-sealed areas, a threshold can be selected based on this knowledge to automatically discriminate between these two classes, i.e.

IF (NDVI\_THR < 0); THEN CLASS='Mainly Developed'.

Another notation employed in this study is based on neighborhood(NB) operations, which groups contiguous pixels belonging to one thematic class. For instance, if applied on an unsupervised classified image, this could enable meaningful group of pixels labeled say 1 to be extracted and separated from another group of pixels having either the same label and not useful or belonging to another class but spectrally having the same values (Erdas Imagine, 8.4, 1999). This can be expressed thus:

IF (Pixel\_Class\_RC\_NB = 11); THEN CLASS = ' Developed'. The label '11' is user defined and depend on the application.

### **3.3 Knowledge Base Rule**

Knowledge can either be declarative which consists of facts and relationships or procedural mostly program codes that eventually facilitate in the identification and classification of the image features. The proliferation of systems that support declarative knowledge representation is attributed to the fusion of artificial intelligence techniques in computer vision. Knowledge is what can be expressed as a rule of thumb, and when applied effectively can lead to a better understanding of the problem under investigation, thus it is application driven. This section emphasizes the type of knowledge that is relevant for this study, specifically the knowledge domain and its subsequent representation within a rule based system.

#### **3.3.1 Knowledge Domain**

The incorporation of additional information makes image interpretation systems more robust. The knowledge exploited in this study can be viewed from the following perspectives, namely the imaging source, application area (in this case urban environments), geographic location or region (which defines the prevailing occurrences e.g. unplanned developments being addressed in this study is a phenomena prevalent in developing countries as opposed to developed ones) and finally the object characteristics. Figure 3.9 summarizes these knowledge sources.

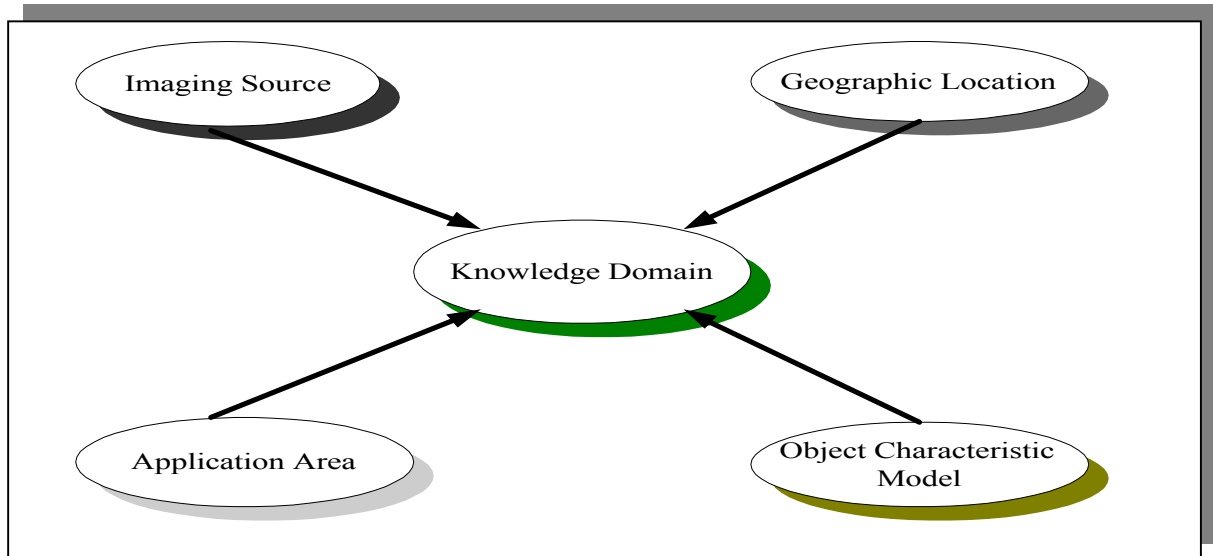

Fig. 3-9: Knowledge Sources

The following section expounds on these knowledge domains:-

### Imaging Source

This refers to basically all the information pertaining to the imaging source, which include spectral, spatial, and temporal resolutions. The choice of sensor data to use is application dependent. An understanding of the imaging source characteristics and the objects in the scene enhances the interpretability of the objects. Ephemeric-sensor data e.g. sensor type (imaging geometry and limitations), latitude and longitude (geographic area covered), date(gives an indication of what to expect particularly for vegetation mapping and change detection purposes), calibration parameters (for subsequent geometric correction), and atmospheric conditions (an indication of the clarity of the image by giving an impression of the cloud cover at the time of imaging) are important information in the selection of the data to use. In this regard, different classifications of available sensors based on different criteria exists in literature e.g. [Kilston, 1996 ],etc, whereas a detailed review of the usefulness of remotely sensed data for extracting attributes for various urban applications is contained in [Jensen and Cowen, 1999].

### Application area

Background knowledge in a certain discipline enhances the ability to accurately interpret features. This is due to the fact that different earth features have different spectral, spatial and structural characteristics. Moreover, the perception of an image scene is problem dependent, e.g. a forester would be interested in tree cover and species as opposed to a geologist whose interest is basically in the rocks. This applies also to other disciplines e.g. the one being addressed here of urban environments. In general, urban application studies include urban land use mapping, transport network mapping, utilities and services mapping, population estimation, property parcels, urban sprawl and slum typology, etc. Planners are normally interested in the optimization use of urban resources by ensuring that planning policies are adhered to. This entails establishing a comprehensive urban configuration ensuring that the resources are appropriately distributed as well zoning laws, for instance, an industrial area is not supposed to border a residential area due to pollution, etc are observed.



## Geographic Location

Most of the problems under investigation are unique to the region e.g. mushrooming of unplanned developments is a situation prevalent in the developing countries as opposed to the developed ones. Consequently knowledge about the geographic area and its corresponding cultural and physical conditions are essential for a better understanding and interpretation of the image features. This has to do with real life problems and how to handle them. This necessitates inputs from different sources and therefore there is a tendency to shift problem solving from top-down approach to an integrated top-down and bottom-up paradigm.

## Object knowledge

Objects have different attributes e.g. shape, color, size, texture, height, site, orientation, function, etc. Image interpreters employ these characteristics to identify and label different objects within a scene. However, depending on the application some attributes contribute more evidence in the discrimination process than others. Hence, an evaluation of the object attributes prior to their integration is important so as to ensure that only those attributes that aid in discrimination are employed. For instance unplanned developments are characterized by densely built up structures with a separation of within 2-3m, diverse construction materials e.g. plastic, tin and asbestos sheeting, wood and cartons, single storied with flat and near horizontal roofs, minimum size of 4 x 4m with roof heights of 2-2.5m having simple geometry of 4-sided shapes, isolated and randomly located on the ground. [Mason and Baltsavias, 1997; Saxena, 2001; Heiko, 2001; Hofmann, 2001].

### 3.3.2 Representation of Knowledge

In this study, the objective is to identify two main object classes namely developed and reserved areas from the image which are used as inputs in combination with other data sets for the detection and identification of unplanned developments as well as monitoring their trend. In general, the approach adopted involves:

- a) identifying the components of the rule base in relation to the problem being addressed. These are in principle, a set of rules which contain:
  - The desired results i.e. the two aggregated classes namely the developed and reserved areas as depicted in figure 3-3.
  - The characterization of developed and reserved areas from Texture, Edge density, NDVI, and unsupervised classification features by means of conditions based on their attributes e.g. gray values, histogram, color, area size. The condition part of the rule may contain a direct simple assignment statement e.g. Pixel Class = 1 or a query which involves external evaluation e.g. recoding (RC), neighborhood operations (NB), or Thresholding (THR).
- b) Configuration of the decision tree and figure 3-10 illustrates this concept.

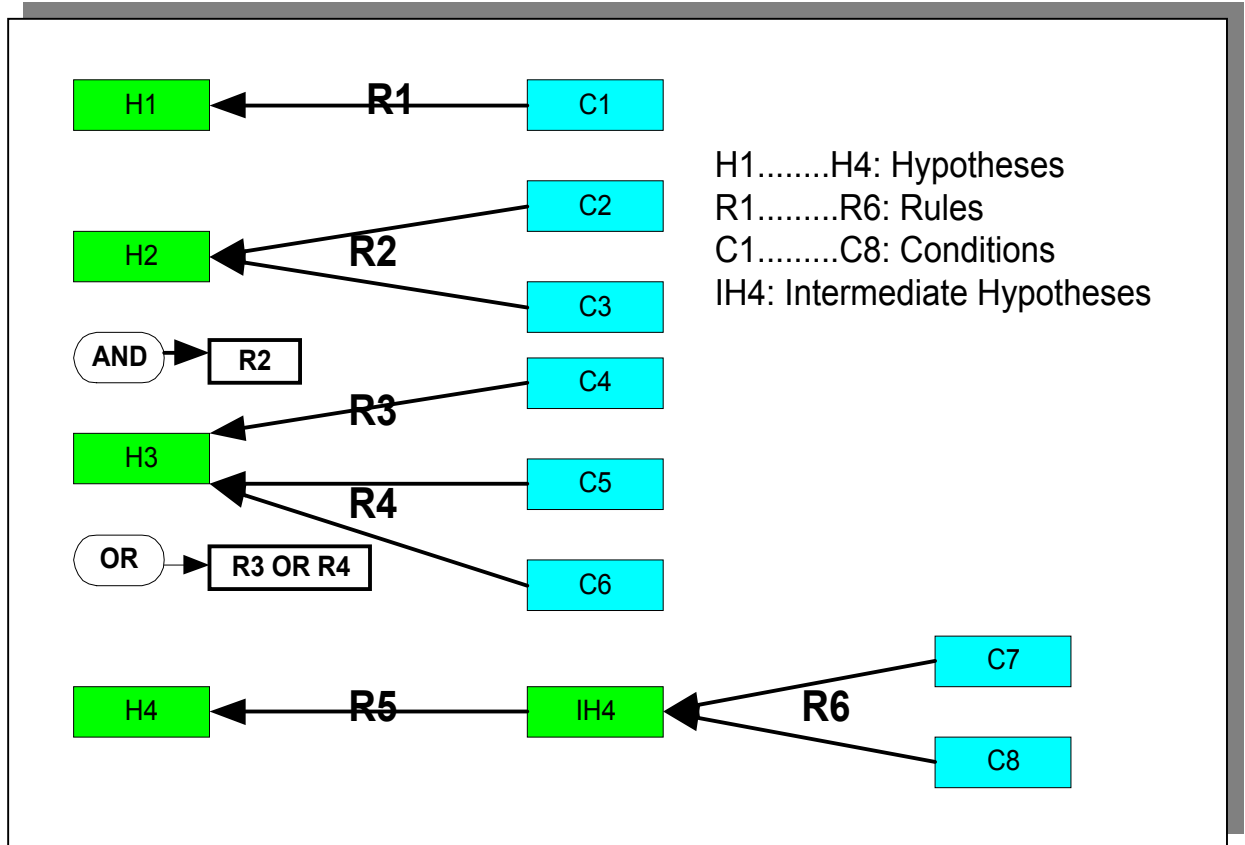

Fig. 3-10: Decision Tree Concept

In principle there are two scenarios in the configuration of the decision tree namely determined by the conjunctions AND and OR.

On the basis of a hypothetical situation using Pixel Class\_RC, Edge Density\_THR and Texture\_THR these can be illustrated thus:

Scenario 1

IF (Pixel Class\_RC = 1) AND (Edge Density\_THR = 1) AND (Texture\_THR > 6);  
 THEN (Predominantly built up area).

In this scenario, the hypotheses 'predominantly built up area' is defined when the three conditions are all true.

Scenario 2

IF (Pixel Class\_RC = 1) OR (Edge Density\_THR = 1) OR (Texture\_THR > 6);  
 THEN (Predominantly built up area)

On the other hand, this scenario depicts a situation whereby any of the three rules need to be true for the hypotheses 'predominantly built up area' to be defined.

c) Control Strategy

This is effected in two ways, namely through ordering of the decision tree and use of

pre-set confidence values, which is the responsibility of the knowledge engineer expert with a good knowledge of the data and the problem being addressed. Ordering of the decision tree refers to the hierarchical arrangement of the multiple rules. The order is important in the event that there are conflicting rules having similar confidence values that fire the same or different hypotheses. When this occurs, the rule that comes first in the decision tree has by default higher priority. This situation could however be altered by using confidence values which are associated with each condition. Two modes are supported whereby they can be explicitly assigned to the rules or computed indirectly from the conditions. This is a very important consideration when setting up the knowledge base as it determines the final output of the interpreted image.

### **3.4 Knowledge-Based Interpretation**

Once the knowledge base has been established the next step involves executing it. In principle, this is the role of the inference engine which involves assembling rule instantiations in a conflict set (Conflict Set Generation) from where one of the rules is fired (Conflict Resolution) based on some criteria e.g. confidence or priority level.

#### **3.4.1 Conflict Set Generation**

The knowledge base contains multiple rules and hypotheses which when executed is expected to yield a suitable solution. Once evoked, the first step involves simply a matching criteria of the left hand side of the rules with the right hand side, whereby successful matches yield rule instantiations. Considering again the example of scenario 2 in section 3.2.2., all the rules that are associated with the object developed are extracted to produce a subset of rules. This is effected through a condition-action pair which defines a discrete unit of problem solving knowledge. Thus the condition part (IF) of the rule determines when a particular rule should be applied whereas the action part (THEN) refers to the associated event. The following example illustrates this concept with respect to this study.

R1: IF (Pixel Class\_RC = 1); THEN (Predominantly built up area)

R2: IF (Edge Density\_THR = 1); THEN (Predominantly built up area)

R3: IF (Texture\_THR > 6); THEN (Predominantly built up area)

#### **3.4.2 Resolution of the conflict**

Here only one rule in the conflict set is fired. Conflict resolution strategies range from straight forward cases, for instance selecting the first rule encountered whose condition matches the hypotheses or they may entail complex rule selection heuristics, e.g. use of pre-set uncertainty or confidence factors. The Erdas Imagine Expert System Shell supports these two control strategies.<sup>4</sup> In the former case, the way the knowledge base is structured and organized is of paramount importance.

---

<sup>4</sup> Other shells e.g. OPS5 uses three criteria namely refraction, recency and specificity [Schenk and Zilberstein, 1990].

If there are two conflicting rules namely R1, R2 referring to the same region in the image and rule R1 is associated with predominantly un-built up area and appears before rule R2 which refers to a built up area, in the hierarchy, then by default, rule R1 will be fired.

However, this default settings could be altered by attaching confidence values to the rules as shown below,

R1: IF (Edge Density\_THR = 1 (0.75); THEN (Predominantly un-built up area)

R2: IF (Pixel Class\_RC = 1 (0.80); THEN (Predominantly built up area)

i.e. Rules R1, and R2 have 0.75 and 0.80 as confidence values respectively. This implies that, the rule with the highest confidence value is fired and in this case R2 is selected. Hence, clustering result is used to classify the pixel as 'predominantly built up area'.

This is a very simple example, which nevertheless illustrates the concept behind conflict resolution. The knowledge base contains ideally multiple rules which must be evaluated in order to yield suitable classes. It is common to find that the same pixel is being assigned to different classes by different rules, and it is the duty of the control strategy to ensure that only the appropriate rule is fired. Moreover, during the establishment of the knowledge base, the knowledge engineer should have sound knowledge of the supported control strategy, in addition to the data and the problem being solved, as this will affect how it will be structured.

### **3.5 Final class representation**

The requirement in this study is to have two informational classes namely developed and reserved. Consequently, this entails aggregation of the output classes from the interpretation process into one of the two categories. Aggregation may be defined as a controlled reduction and simplification of geographical data. In general, aggregation or generalization is based on some criteria and may involve use of topology, geometry, hierarchical space partitioning and local triangulation [Ruas, 1995]. Figure 3-11 elucidates this concept, which essentially translates into:

IF (H1, H2, H5, etc); THEN CLASS = 'Developed'.

Where H1, H2, H5, etc are the classes that constitute developed areas e.g. transport system, residential areas, commercial, industrial, etc.

The same case applies to the reserved areas whereby for instance H4, H3 and H6 could hypothetically refer to green areas, playing fields, forest areas respectively, then this can be illustrated similarly:-

IF (H3, H4, H6, etc); THEN CLASS = 'Reserved'

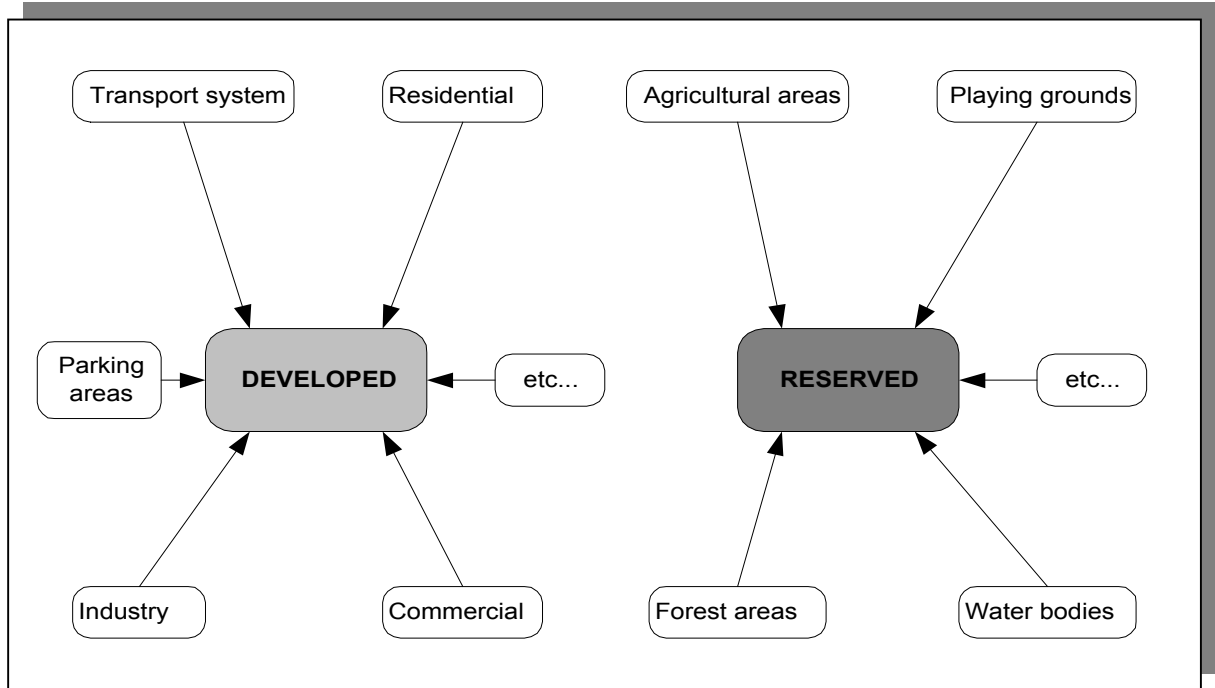

Fig. 3-11: Class Aggregation

*The image interpretation module adopted in this study is elucidated with special emphasis on knowledge acquisition and representation for purposes of discriminating between developed and reserved areas from multispectral images.*

## CHAPTER 4

### DETECTION AND TREND MODELLING MODULES

#### 4.1 General overview

This chapter focuses on the detection and trend modeling modules of the unplanned developments proposed in this study. Specifically, the emphasis is on the combination of remotely sensed data with planning data for purposes of the detection, whereas monitoring the trend of this phenomena so as to establish the tendencies that leads to its expansion is based on ancillary information e.g. existing infrastructure, hydrography, demography, elevation, etc. Planning data provides information pertaining to the type of permitted land uses and their spatial extent in a given locality, whereas remotely sensed data lends itself to a useful source for deriving land use information. Moreover, the frequent ground coverage by remotely sensed sensors, enables changes to be easily detected. Figure 4-1 highlights the detection and trend modeling modules within the proposed methodology.

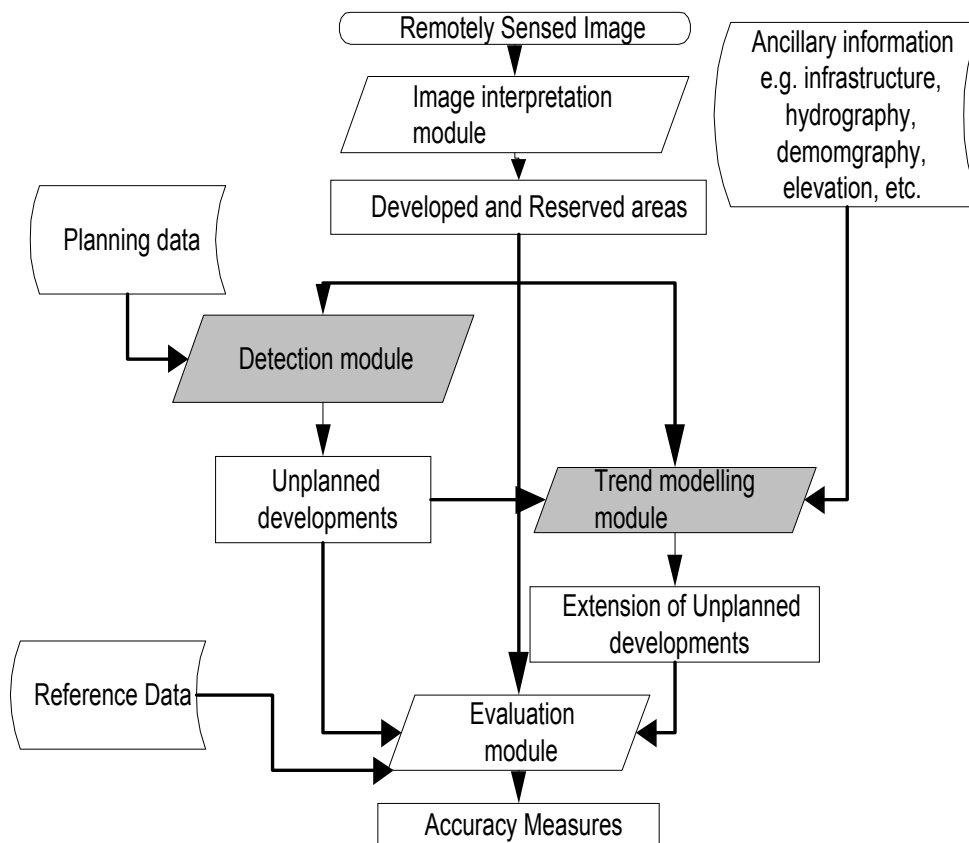

Fig. 4-1: The Detection and Trend Modelling Modules

#### 4.2 Unplanned Developments and Their Trend Prediction as Indicators for an Urban Environment

Urban environments experiencing rapid growth specifically due to unplanned developments could be monitored by use of indicators which essentially provide information on the localization and extent of these phenomena (detection of unplanned developments) and subsequently highlight areas that are prone to their expansion (trend prediction). These two indicators can be incorporated within the Driving Force-Pressure-State-Impact Response

Model, on Indicators for Sustainable Development [ISD, 1997] as shown in figure 4-2 as State and Response Indicators respectively. In general, *Driving Force indicators* refer to human activities, processes and patterns that have an impact on sustainable development (in this case rural-urban migration and poverty are the main contributing factors to unplanned developments); *Pressure indicators* describe the factors that cause environmental problems (the adverse effects of unplanned developments include pollution, water shortages, congestion and inadequate health and education facilities, increase in crime rates, etc) ; *State Indicators* show the current condition of the environment (the mushrooming of the **unplanned developments**); *Impact Indicators* emphasize the effects arising from the changes in the environment (in this context this could refer to land tenure problems, inadequate housing, etc), whereas the *Response indicators* are the policy options and efforts undertaken to address the changes in the state of the environment (this include measures e.g. upgrading of the housing conditions, ensuring security of tenure, **predicting their trend**, etc).

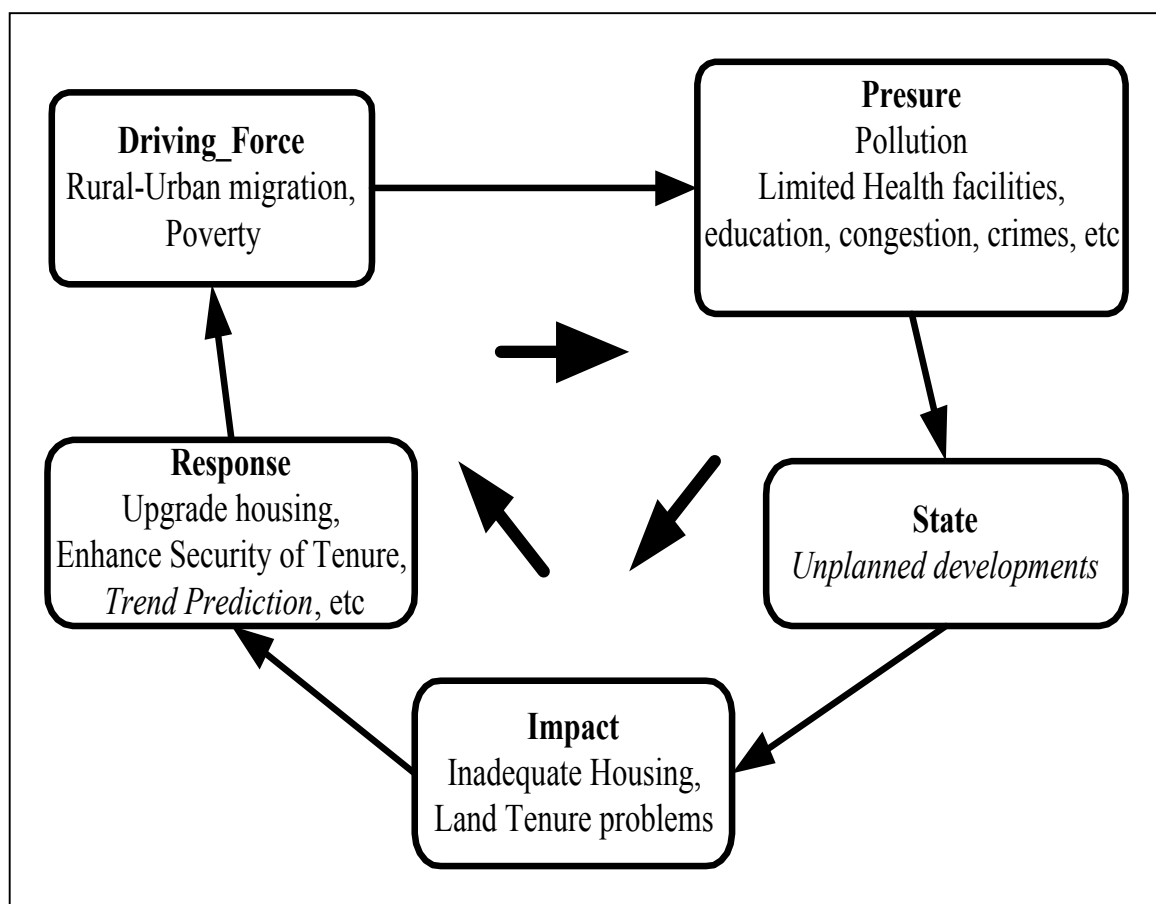

Fig. 4-2: Indicator Category and Type (Modified after Jesinghaus, 1999)

The detection and trend prediction involve integrating data from different sources and hence it is important to review the technical aspects of the data sources. In this regard, the following sections elucidate on the technical considerations.

#### 4.2.1 Technical Prerequisites

In addition to accessibility problems of data, due to the fact that it is held across different organizations, the integration of these data sets is curtailed by the existence in different

formats, scales and level of detail. Within the context of urban environments studies, relevant data could be in the custody of e.g. Central Bureau of Statistics, government ministries (land, transport, finance, health, etc), research organizations and institutions, private firms, etc.

The format of these data sets refer to availability in either hardcopy or digital, where in developing countries the former is more common. Further, even in the event where data is in digital format, each organization manages its own data accordingly, with disregard to the other organizations. This is primarily due to the fact that there is minimal or lack of co-operation between the various organizations or stake holders.

An important aspect in integration is in the geo-referencing of the different data sets. Generally, data is acquired differently, i.e. from different sources and methods, and therefore accuracy. Consequently this entails geo-referencing, e.g. in this study building plans and the remotely sensed data for the detection of unplanned developments or remotely sensed data with land use data, transport network and hydrography for monitoring their trend.

The ground resolution which determines the level of detail is also an important consideration. This is dictated by the area of application and the problem being investigated. The focus in this study is the detection of unplanned developments as well as monitoring their trend. Hence, the aggregate level adopted is that of two main classes namely developed and reserved.

With this background the following sections expound on the concept developed in this study for the detection and trend prediction of the unplanned developments.

### **4.3 Detection of Unplanned Developments Module**

The concept behind the detection of unplanned developments as adopted and developed in this study is the subject of this section. Specifically the input data sets, the definition of the As It Should Be situation as an important input in the detection process and the detection process (comparison) as shown in figure 4-3. Each of this step is expounded in the following section.



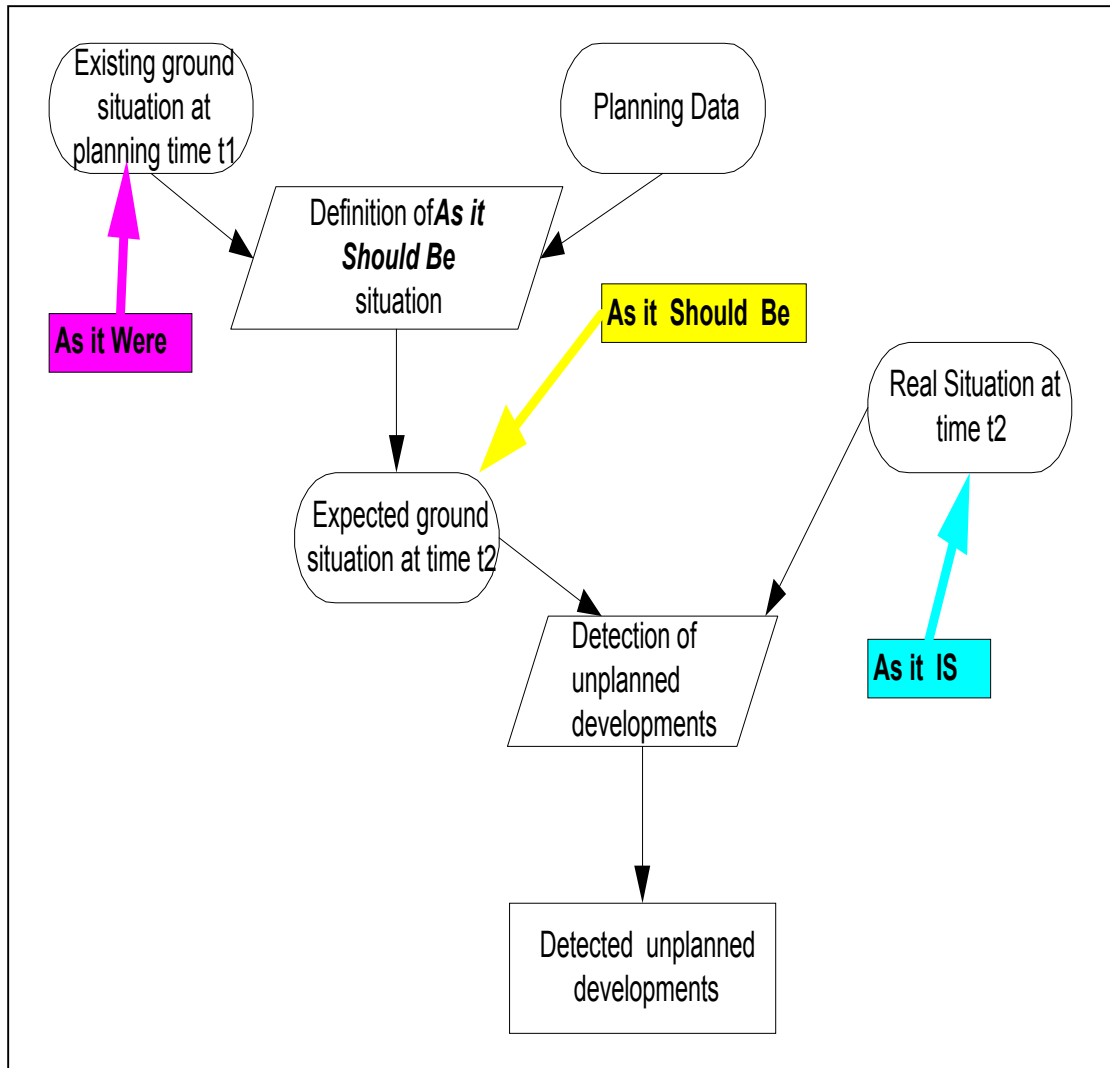

Fig. 4-3: The detection of unplanned developments

#### 4.3.1 Input Data for the Detection of the Unplanned developments

The transition of reserved areas to developed can be attributed to various variables namely, initial status i.e. current use; existing demand for land; infrastructure availability; physical constraints and the implications in overcoming them; zoning controls and limitations; and existing use of neighboring sites. Ideally, different alternatives are evaluated based on the various variables to establish the most appropriate land use to allocate to developable land units.

In general, for an urban area these are reflected in the future land use maps or building plans. Both these two data sets depict the permitted land uses with the detailed specifications citing the type, extent, time frame within which it is to be implemented and the limitations thereof. However, the future land use maps cover regions and are more general as opposed to the building plans which are more project oriented and hence localized and very detailed. Figure 4-4 shows an example of a future land use map of the Hannover Expo area. It is evident that the level of generalization is high in future land use plans, where the emphasis is on zoned areas for particular uses and therefore not useful for this study. On the other hand, for the same area depicted on the future land use, a total of 9 building plans cover this area and an example of a building plan (number 1557) is shown in figure 4-5. On such plans, the

emphasis is on the exact type and extent of use, which are clearly indicated. It is this detailed information on building plans which has been exploited in this study in combination with the existing ground situation (**As It Were**) at the time of planning provided by remotely sensed data to generate the **As It Should Be** situation.

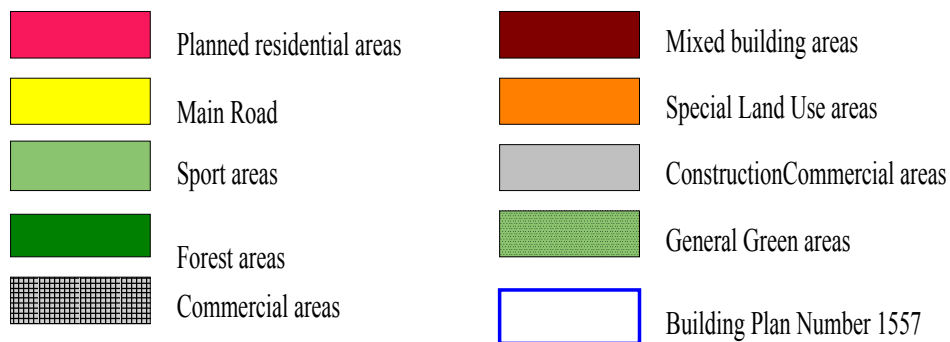
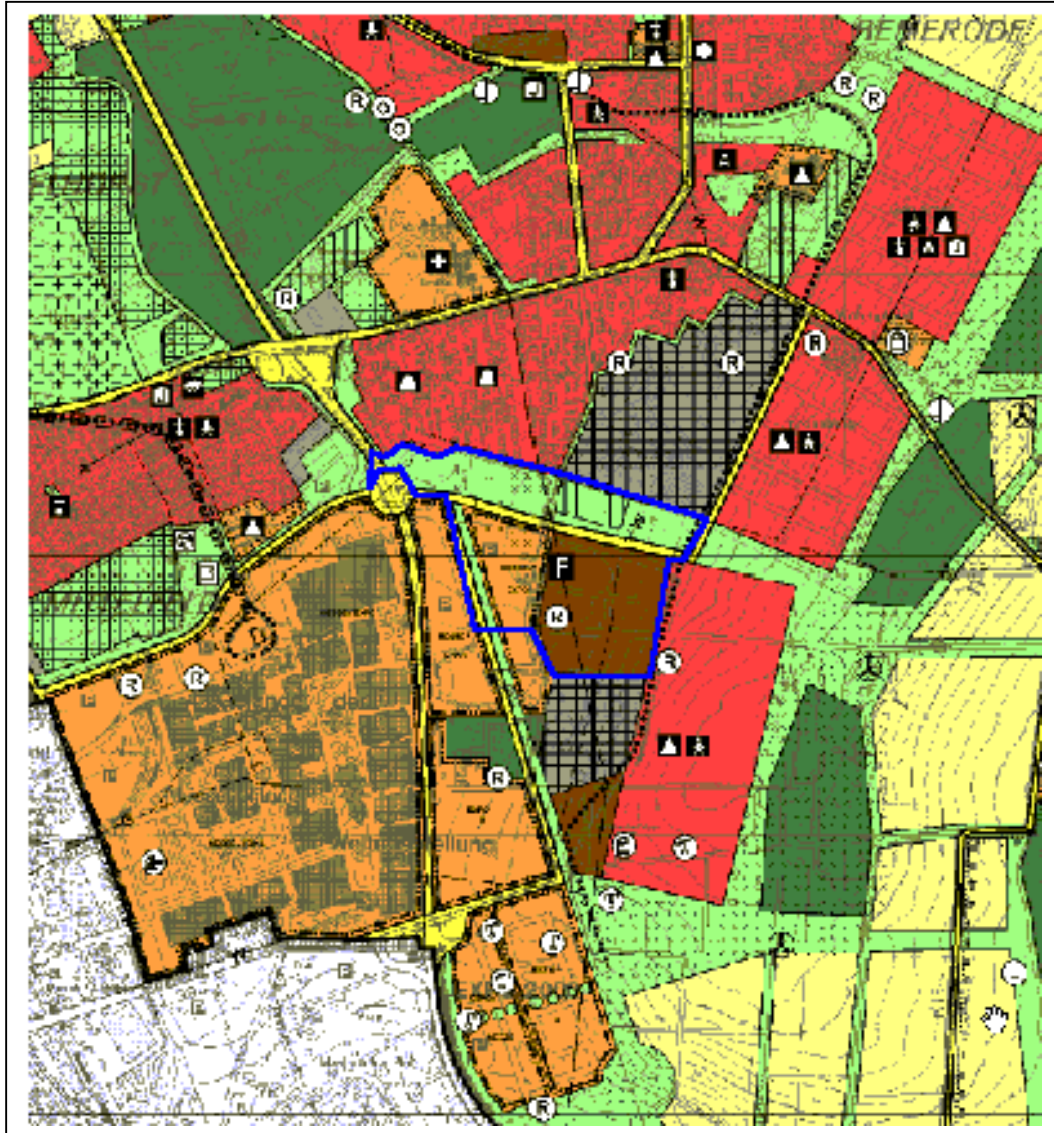
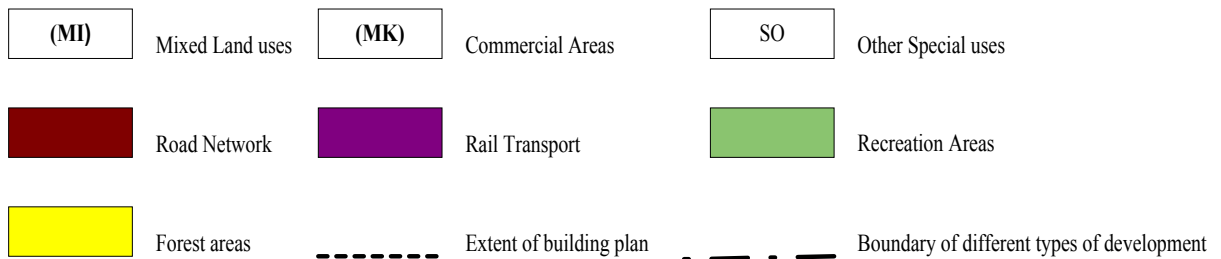
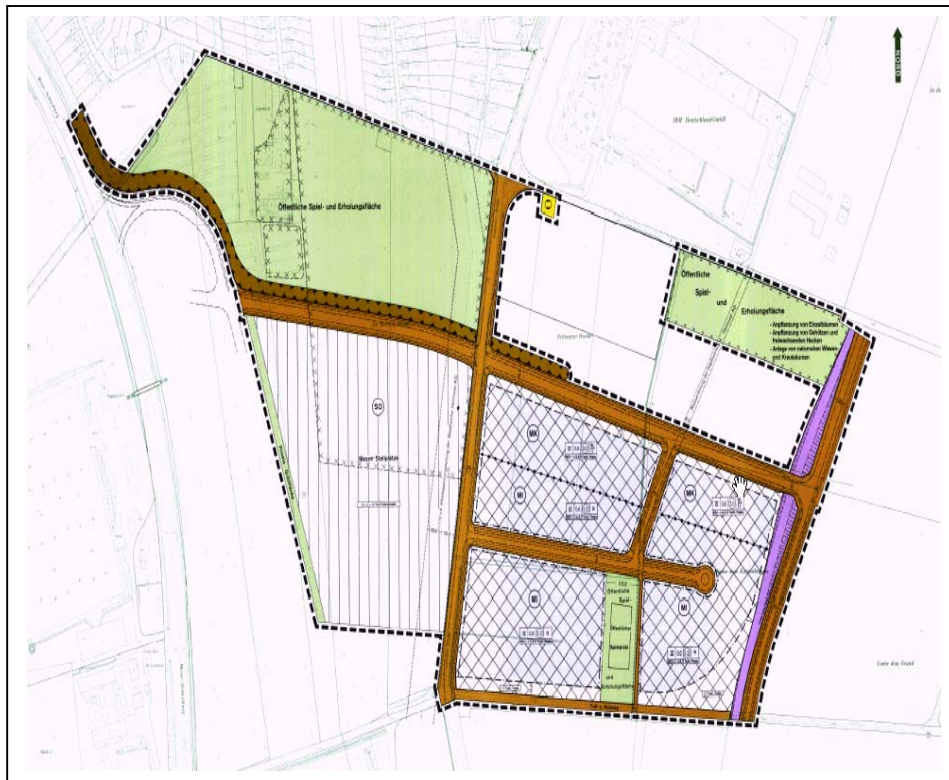

Fig. 4-4: Future Land Use Map



**Scale: 1:2000**

Fig. 4-5: Building Plan Number 1557

#### 4.3.2 Definition of the *As it Should Be* Situation

As inputs, the planning information derived from building plans shows the extent of developed (D) and reserved (R) areas, whereas the remotely sensed data depicts the existing situation at the planning time (As It Were) specifically existing developed (Dex) and reserved (Rex) areas. The combination of these two data sets is realized by using GIS matrix operation, which basically creates an output showing the relationship between the classes of the two input data sets which in the context of this study translates into the As it Should Be situation with emphasis on the legal transition(LT) areas. The output is always in raster format, whereas the inputs could either both be vector or raster. For the purpose of the prototype system being developed in this study vector inputs were used. Figure 4-6 is a schematic diagram showing this concept.

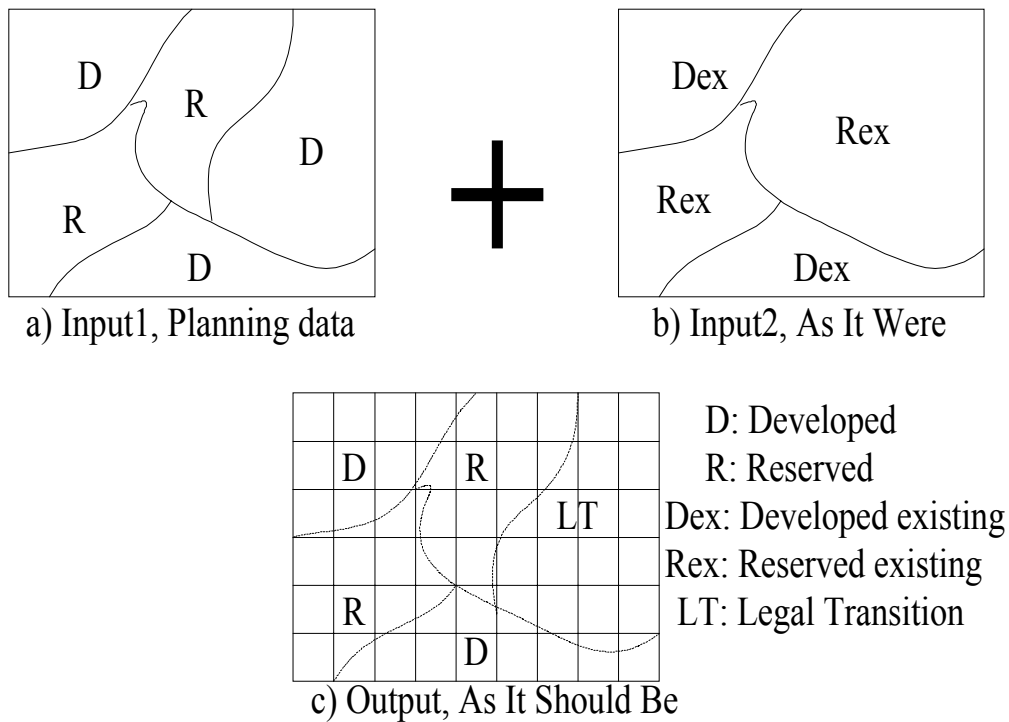

Fig. 4-6: The definition of the concept of **As It Should Be** Situation

### 4.3.3 The Detection of Unplanned Development Process

Once the expected ground situation (**As it Should Be**) has been defined, the next task is to incorporate this information in the detection of unplanned developments. A second input is required into the system to facilitate this process, and this is information showing the status **As it IS** at the elapse of the planning and implementation time frame (see figure 4-3). The study proposes use of remotely sensed data as the source of this information due to the frequent coverage, thus ensuring availability. The concept underlying the extraction of developed and reserved areas from remotely has been treated in Chapter 3. Figure 4-7 shows a schematic diagram illustrating the detection of this phenomena.

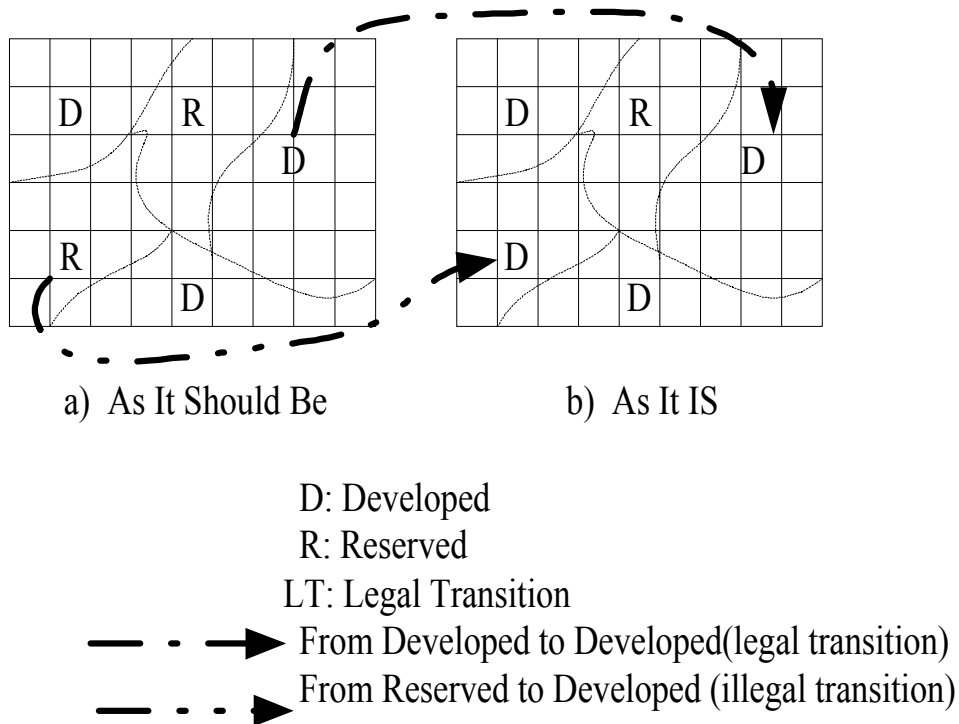

Fig. 4-7: The concept underlying the detection of unplanned developments

Equipped with these two sets of status, then the following conclusions can be drawn:

IF ('As it IS' = 'As it Should Be');  
 Then Change = <sup>5</sup>'Planned Developments';  
 Else Change = <sup>6</sup>'Unplanned Developments'

Thus new developments will be unplanned developments if the two status namely '**As it Should Be**' and '**As it IS**' are not in agreement otherwise the transitions will be legal or planned.

#### 4.4 Prediction of the Extension of Unplanned Developments

One way of addressing the proliferation of unplanned developments in a timely manner is to have a mechanism of predicting their occurrences. In general prediction involves modeling based on some criteria. In this study, one of the inputs that is being proposed is the existing and already detected unplanned developments in combination with other variables, whereby in the case of the prototype developed in this study, transport network and hydrography have been employed. These are used to generate areas that likely to be extensions of unplanned developments, which are then combined with newly developed areas extracted from remotely sensed data to establish whether developments have really taken place. This process is shown in figure 4-8.

<sup>5</sup> Planned developments and legal transitions in this context are synonymous.

<sup>6</sup> Unplanned developments and illegal transitions are also in this context synonymous.

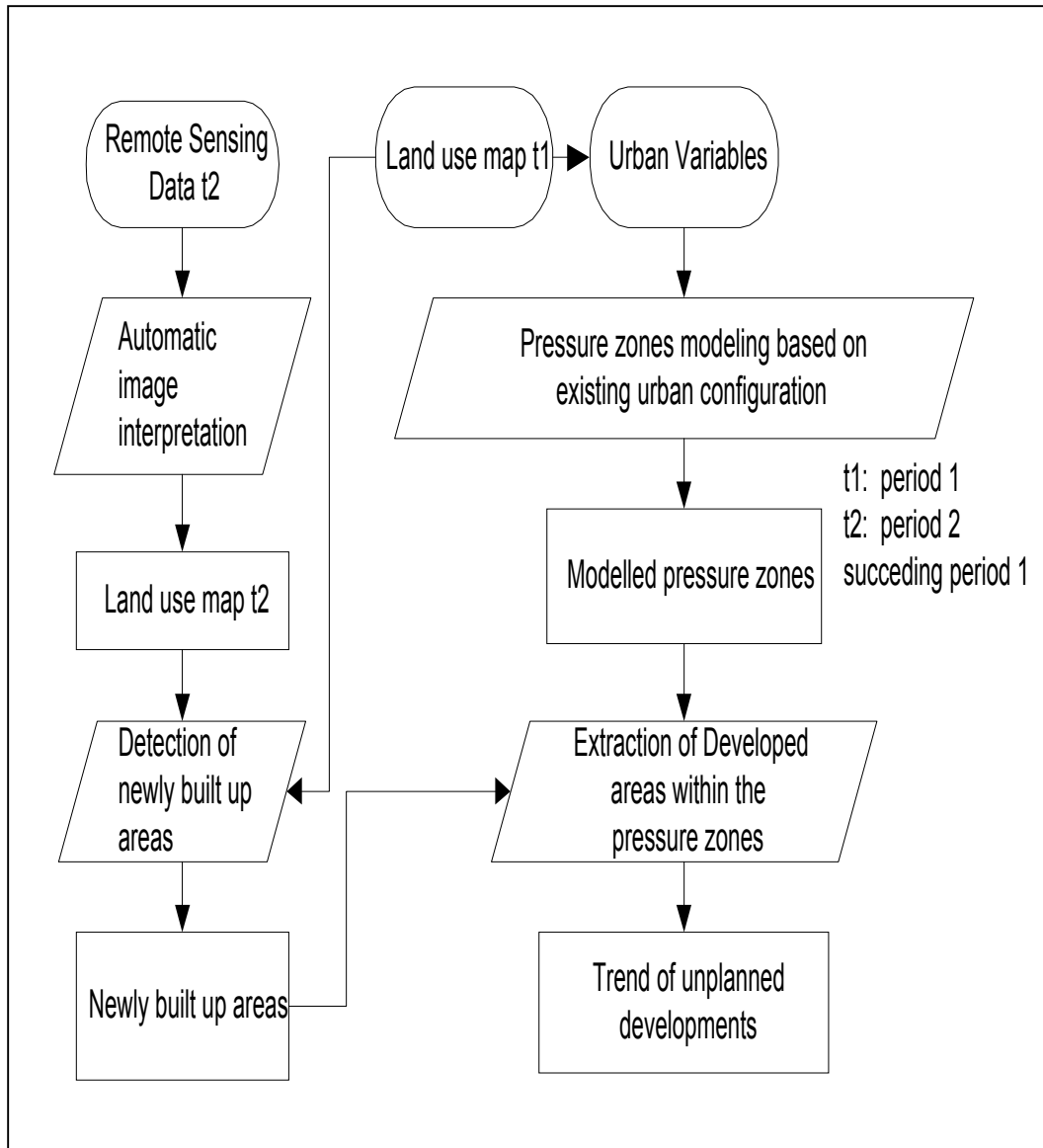

Fig. 4-8: The Prediction of the unplanned developments process

#### 4.4.1 Input Data for the Prediction of the Extension of Unplanned Developments

The rate of development of the reserved areas depends on a number of factors e.g. neighborhood use, infrastructure availability i.e. transport, sewage system, etc. Figure 4-9 shows an overlay of data sets consisting of a land use map showing among other things the developed, reserved and unplanned developed areas, with main transport network and hydrography for Dar-esalaam. This gives a general impression of the existing situation with regard to the distribution of physical resources. Thus, it is safe to assume that some areas will develop faster than others depending on the demand for land. Within the framework of this study, when new developments occur, it would be in the interest of planners to have the capacity to quickly establish whether the new developments are extensions of the already existing unplanned developments. This will involve defining the pressure zones based on some urban variables as shown in figure 4-8. The choice of which variables to use will depend on whether they are available and some basic knowledge of the area (e.g. cultural practices) as well as the degree of the influences of this variables on this phenomena. The

variables tested in generating the pressure zones in this study include neighborhood, ease of communication and proximity to hydrographical features.

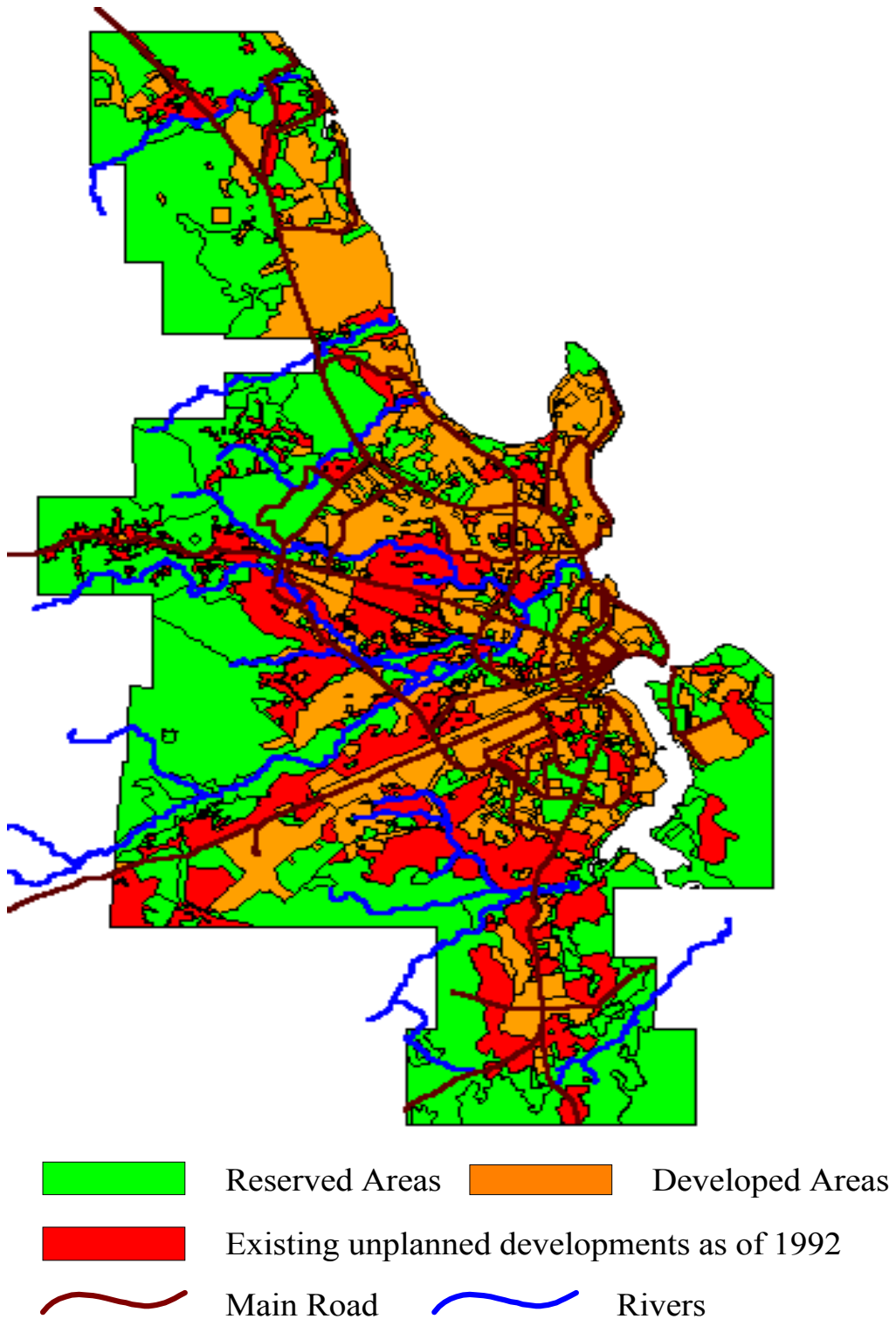

Fig. 4-9: Land use coverage with an overlay of river and main roads coverages



#### 4.4.2 Pressure Zones Modeling

Figure 4-10 is a schematic diagram illustrating the rationale underlying modeling of the pressure zones. If for instance, areas A and B are new developments obtained from remotely sensed data, then by virtue of this configuration it would be logical to assume that area A is very likely an extension of unplanned developments whereas area B is least unlikely. The neighborhood plays an important role in this case, the existing unplanned developments. On the other hand, B is within the vicinity of planned developments and transport network thus making it more lucrative for planned development as opposed to unplanned.

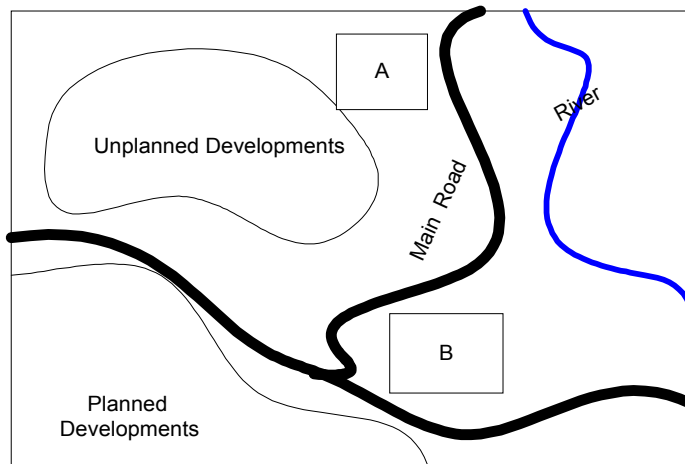

Fig. 4-10: The concept of modeling pressure zones based on the existing urban configuration.

The implementation of this concept is based on buffering whereby reasonable buffer distances are assumed on the basis of the knowledge of the area and the phenomena under consideration in this case unplanned developments. Figure 4-11 shows four pressure zones namely PA, PB, PC, and PD.

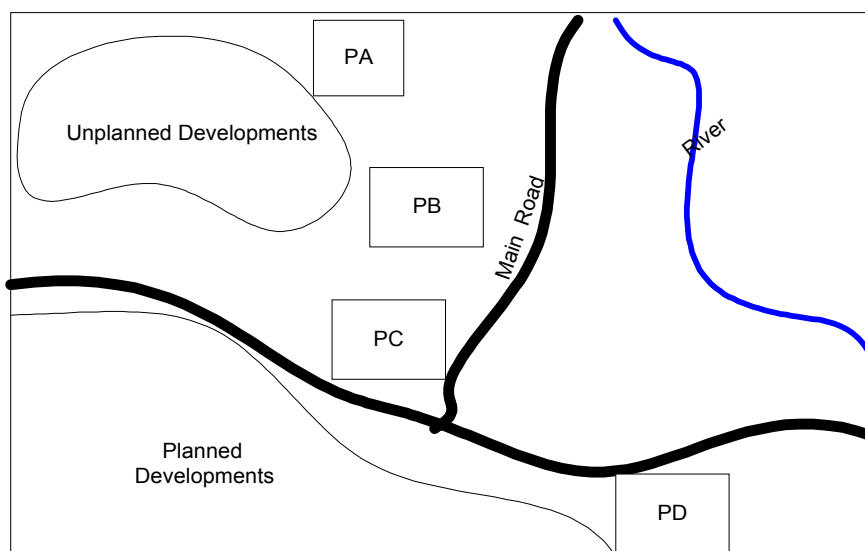

Fig. 4-11: Pressure Zones Definition



By varying the buffer distances based on the three variables namely unplanned developments, transport network, and hydrography, the individual influence on the newly developed areas can be established. However, in this study, the idea is to employ the three influences whereby the proximity to the unplanned developments is varied (i.e.  $x_1, x_2, x_3, x_4$  where  $x_4 > x_3 > x_2 > x_1$ ) whereas that of proximity to the main transport network ( $y$ ) and hydrography ( $z$ ) are maintained constant. Thus, we can therefore conclude that:

```

IF( Buffer is within  $x_1$  and  $y$  and  $z$  );
    Then Pressure Zone = PA;
Else IF( Buffer is within  $x_2$  and  $y$  and  $z$  )
    Then Pressure Zone = PB;
Else IF( Buffer is within  $x_3$  and  $y$  and  $z$  );
    Then Pressure Zone = PC;
Else IF( Buffer is within  $x_4$  and  $y$  and  $z$  );
    Then Pressure Zone = PD.

```

#### 4.4.3 Definition of Modeled Extensions of Unplanned Developments

Modeling aims at generating alternative scenarios of possible developments based on some reasonable rationale. Social, environmental, economical, etc indicators influence the rate of urban dynamic. The incorporation of these indicators in assessing growth facilitate the planners in weighting their influences accordingly. There are two types of influences that should be distinguished namely independent and combined, whereby independent refers to each indicator in isolation whereas combined is the effect of all the indicators. Nevertheless, a more ideal approach is one that incorporates all the influences, but realistically its not possible to exhaustively include all of them due to the complexity of the real world. In this study three environmental indicators have been tested namely existing unplanned developments, transportation network and hydrographic information. The pressure zones (figure 4-11) identified may not have the same likelihood of being extensions of unplanned developments, and therefore a rating of between very likely and unlikely is used for this purpose.

On this basis, the following conclusions can be drawn,

```

IF ('Land use map t2' = 'Land use map t1');
    Then Status = 'No new developments';
Else IF ('New Developments Fall within Pressure Zone PA');
    Then Status = 'Very Likely Extension of Unplanned developments';
Else IF( 'New Developments Fall within Pressure Zone PB');
    Then Status = 'Likely Extension of Unplanned developments';
Else IF( 'New Developments Fall within Pressure Zone PC');
    Then Status = 'Maybe unlikely Extension of Unplanned developments';
Else IF( 'New Developments Fall within Pressure Zone PD');
    Then Status = 'unlikely Extension of Unplanned developments'.

```

The categorization of newly developed areas on a fuzzy scale namely very likely to unlikely extensions of unplanned developments, would facilitate planners in prioritizing the reaction planning process.

*The concept of detecting and monitoring unplanned developments has been described, specifically the basic considerations in implementing such a methodology including inputs and the algorithms.*

## CHAPTER 5

### EVALUATION MODULE

#### 5.1 Overview

The purpose of evaluation is to determine the quality of the derived information. From a practical point of view, this is expressed by accuracy measures which essentially refer to the degree of correspondence between observation and reality. Accuracy requirements vary from one application to another, and ideally they should be known apriori since they dictate the quality of the data sets and the algorithms to be used. Figure 5-1 highlights the evaluation module within the proposed system for the detection and prediction of trend of unplanned developments.

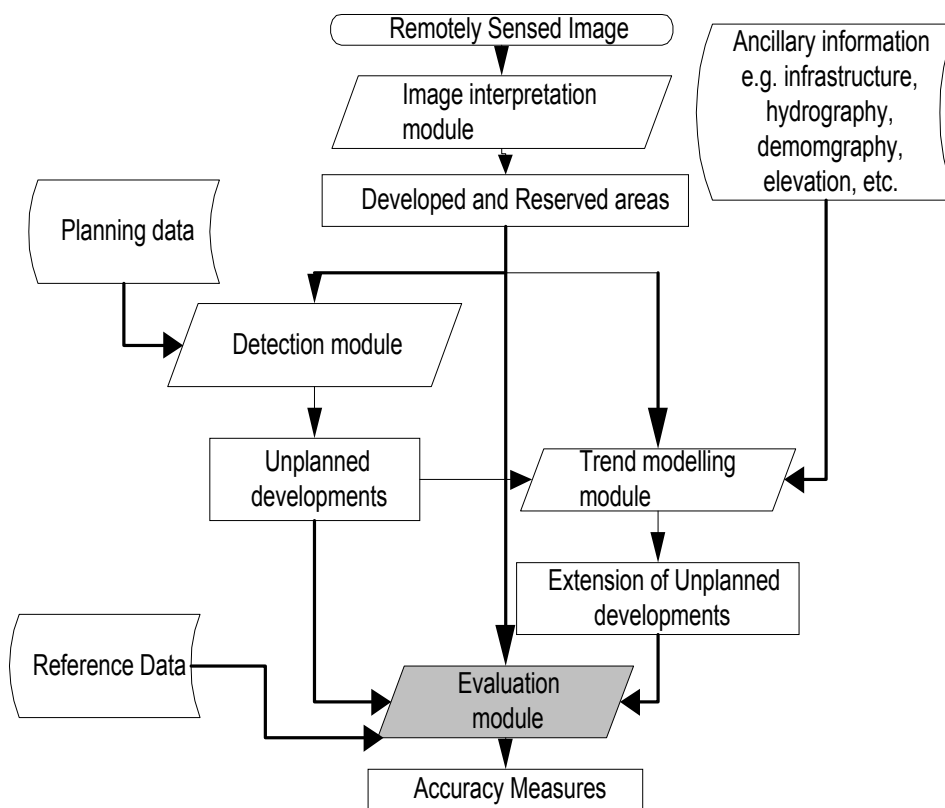

Fig. 5-1: Evaluation Module

In this study three sets of information require to be evaluated namely extracted developed and reserved areas, detected unplanned developments and the predicted extensions of unplanned developments as shown in figure 5-1. The concept and the methodology in the extraction of this information is treated in chapters 3 and 4. The focus here therefore, is to generate accuracy indices on the basis of some reference data as a measure of the suitability of the information extracted and the algorithms used.

Ideally, the epochs should be temporally about the same for the reference and the interpreted image to avoid errors introduced by interpolation. As a general rule, the level of accuracy obtainable in a remote sensing classification depends on diverse factors, such as the suitability of training sites, the size, shape, distribution, and frequency of occurrence of individual areas

assigned to each class, the sensor performance and resolution, and the methods involved in classifying (visual photo-interpretation versus computer-aided statistical classifying), among others.

In general, errors could emanate at any one of these three levels namely:

- **Data Acquisition Errors:**  
These could be attributed to sensor performance, platform stability, and viewing conditions. They can be reduced or compensated by carrying out systematic corrections e.g. by calibrating detector response with on-board light sources generating known radiances. Further, corrections, can be modified by ancillary data such as known atmospheric conditions, during the initial processing of the raw data.
- **Data Modeling Errors:**  
The information extraction algorithms are normally not 100% efficient. They range from simple statistical algorithms to expert systems employing cognitive knowledge in the interpretation process. The ability to model objects within the scene determines how well they are discriminated from each other. The limitations involved in modeling of real world objects leads to some errors.
- **Scene-dependent Errors:**  
These are application dependent and refer mainly to the location and classification accuracy. The former refers to how well the mapped objects correspond to the real objects on the earth whereas classification accuracy deals with how well an object has been identified on the image.

In this regard, the emphasis is on errors that propagate at the two levels namely during data modeling and as a result of the scene characteristics. In general, the backdrop for any evaluation is normally based on existing maps, large scale aerial photographs or field checks. Hence, the two main aspects namely the choice of the reference data and a suitable comparison algorithm are of paramount importance and are treated in the following sections.

## **5.2 Reference Data**

Different functions of reference data has been reported in literature e.g. [Lilesand and Kiefer,1999]. In this study, the function is to verify the extracted information. In this regard, there are two dimensions to the reference data, namely procurement (i.e. source) and usability (technical aspects). The following section expounds on the sources of reference data and the technical aspects.

### **5.2.1 Sources of Reference Data**

The source of reference data is normally generated from in situ investigation involving field measurements or quite often from the interpretation of remotely sensed data at higher scale or resolution e.g. aerial images.

Field checks are normally qualitative accuracy assessment where the idea is to establish how well the labeling of the interpreted image correspond to the ground situation. This is done for both areas which were difficult to discriminate or label and the straightforward ones. During sampling, i.e. which areas to visit, accessibility should be considered i.e. the terrain should be such that such areas are reachable, security in terms of safety, some areas e.g. slums or squatter areas are known to have high crime rates. GPS could also be used to physically locate some problematic areas. In addition use of questionnaires could be employed in collecting

some information thus facilitating in the understanding of the background of some phenomena especially those undergoing rapid changes.

On the other hand use of higher resolution data e.g. aerial images overcomes the problem of accessibility with the field checks. It is also less time consuming in comparison to the field checks and moreover, quantitative assessment can be conducted. However, when dealing with dynamic phenomena e.g. unplanned developments, the chance of having aerial images acquired at the same time and therefore reflecting similar ground situation as the satellite image is quite remote, especially in developing countries due to cost constraints. Hence, from a practical point of view, this source is more likely to be outdated and therefore not useful for accuracy assessment. Nevertheless, a combination of the two sources could be employed as in the case for the Dar-esalaam ground truth data sets.

### **5.2.2 Technical Aspects of Reference Data**

In general, assessments can be either qualitative or quantitative, whereby qualitative assessments are more concerned with the general accuracy. On the other hand, quantitative assessments attempt to identify and measure remote sensing-based map error. In all these assessments, the ground truth data is assumed to be 100% correct which necessitates consistent and vigilant quality control during procurement. Within the framework of this study, there are technical issues that should be considered regarding this data, namely:

- Temporal resolution necessitates that the reference data be acquired as close to the time of acquisition as possible due to inevitable landscape changes. This is especially critical for dynamic applications for instance in this study where the focus is on urban growth. This is to ensure that any changes extracted from the source information can be appropriately related to the reference data. Moreover, it should contain also specific information as to whether the changes are planned or unplanned.
- The spatial resolution implies that the level of detail should allow for a reasonable comparison. In general, the data employed as the reference are largely abstractions, often thematic, recording one or more surface types or themes while overlooking others, depending on the purpose and the details being emphasized (level of generalization). On the other hand, the sensor takes a synoptic view of all surface features with limitations of detector resolution and object characteristics. Consequently, when quantifying accuracy, the lack of equivalence and totality should be taken into consideration
- Co-registration is one of the minimal requirements in accuracy assessment. This is to enable comparisons to be made either by overlaying the extracted information on the reference data or by carrying out automatic statistical comparisons. Errors that would arise from localization would be prevented or minimized if the two data sets are well co-registered.
- Sampling scheme and the number of reference points is an important consideration as this determines whether or not the evaluation is rigorous. Sampling schemes include simple random to directed approaches e.g. stratified and equalized random sampling. It has been reported that simple random sampling has the disadvantage of under-sampling whereas the latter schemes tend to over-sample. Several researchers have different recommendations pertaining to the sample size. As a rule of thumb, a minimum of 50 samples per each land use category have been suggested, but this should be increased if an area is large in which case the minimum number of samples should be between 75 or 100 [Lillesand and Kiefer, 2000].

- The sample unit varies across different applications and this could be individual pixels, group of pixels (clusters) or polygons. It does also depend on the reference data available, for instance where the reference data is vector then the sample unit should also be polygons, whereas where high resolution remotely sensed data is used e.g. aerial photographs then the choice of whether single pixels or clusters of pixels are used will depend on the level of processing or segmentation.

Inherent characteristics of the available reference data should be taken into account. This is in the event maps are used as reference, since they possess their intrinsic or absolute accuracy. However, currently more often than not they have a statement of confidence level attached. For instance, the U.S. Geological Survey has reported results of accuracy assessments of the 1:250,000 and 1:1,000,000 land use maps of Level 1 classifications based on aerial photos, that meets the 85% accuracy criterion at the 95% confidence level.

### 5.3 Evaluation Indices

Different accuracy indices for purposes of evaluating extracted information have been reported in literature, and they include producers accuracy, users accuracy, overall accuracy, average accuracy, combined accuracy, and kappa coefficient of agreement [Fung and LeDrew, 1988]. Within the framework of object extraction and identification, they are used to establish in a quantitative way the correctness of object localization and labeling. [Rosenfield and Fitzpatrick-Lins, 1986].

- Producers accuracy refers to the number of correctly identified and labeled samples for a given class with respect to the total number of reference samples for that category. Thus it gives an indication of the error of omission.
- On the other hand, the users accuracy is a measure of the error of commission and it is basically the number of correctly identified and labeled samples for a given class with respect to the number of samples interpreted as belonging to that class.
- The overall accuracy is a measure of the total correctly interpreted samples with respect to the entire number of samples. Thus it gives an impression of how well the entire image has been interpreted.
- Average accuracy is the average of the individual categories in which case this could be either the producers or users accuracy.
- The combined accuracy is the average between the overall and average accuracy. The biases in both the two indices are minimized whereby the overall tends to be biased for the classes with large number of samples whereas the vice versa is true for the average accuracy.
- The kappa index is a measure of the agreement between the interpreted image and the reference data. This has been discussed further in section 5.3.3 and its application in this study.

In addition to the kappa Index, visual comparison and polygon-pixel count have also been employed in this study. The following sections discusses the implementation of these techniques within the context of this study.

### 5.3.1 Visual Comparison

This is one of the simplest techniques in accuracy evaluation. From a practical point of view, it is easily implemented. It basically involves comparing the extracted information with the reference data thereby giving an impression of the degree of correspondence. This comparison could entail simply overlaying the interpreted information on the reference data or arranging them side by side for ease of comparison. Figures 5-2a and 5-2b illustrates this concept where the reference data is also raster based, whereas figures 5-2c and 5-2d have as the reference data as vector based. From this examples it is possible to make a comparison and establish which pixels have been correctly labeled as developed and reserved as defined in chapter 3.

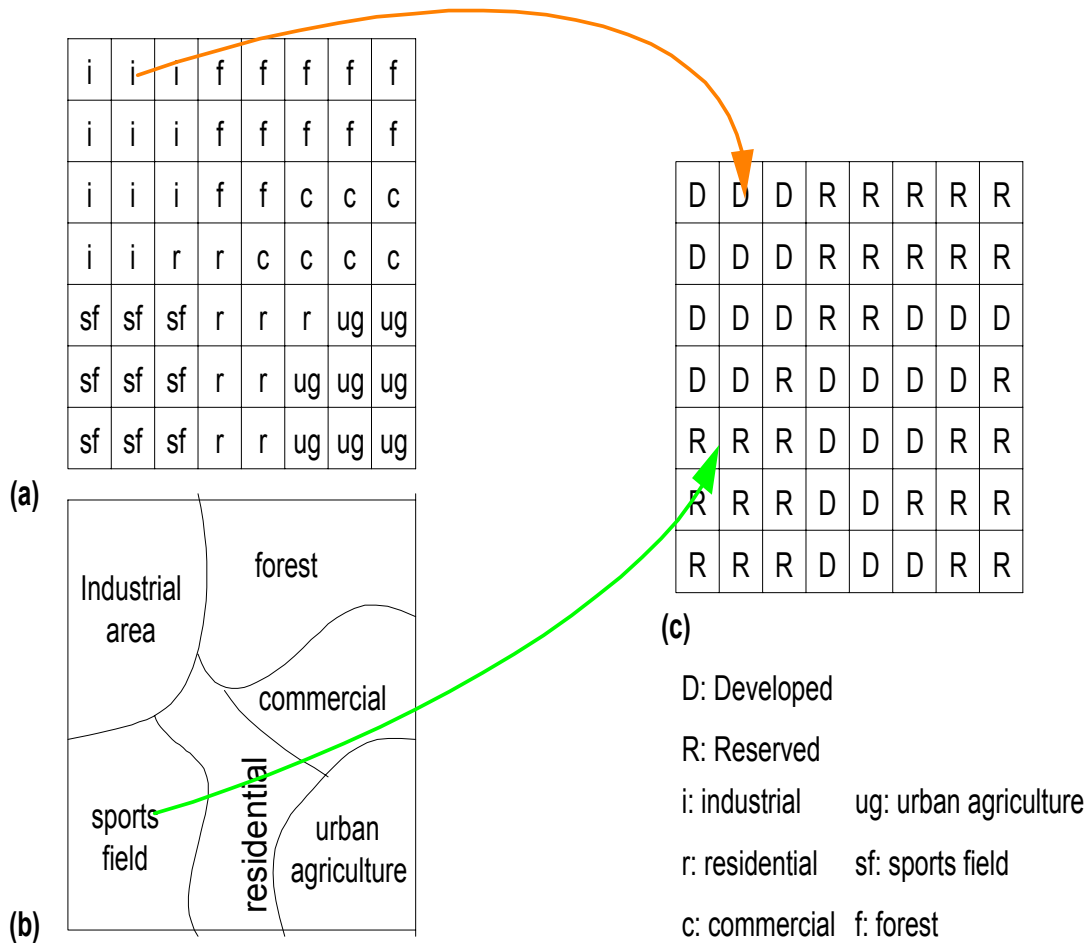
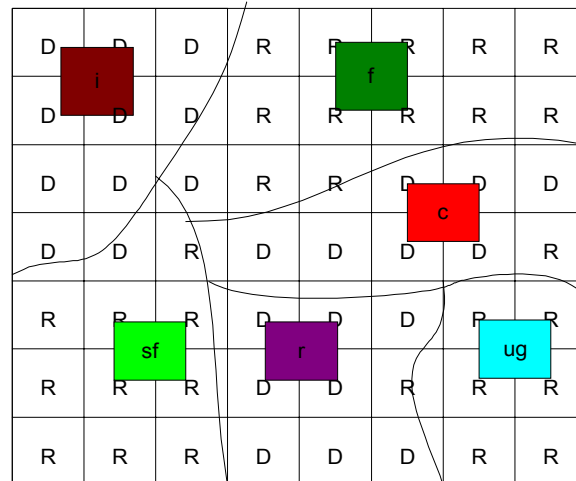

Fig. 5-2a: Reference raster data  
 Fig. 5-2b: Reference vector data

Fig. 5-2c: Interpreted data



(d)

Fig. 5-2d: Overlay of interpreted data with vector reference data

### 5.3.2 Polygon-Pixel Statistics

The basic requirement in this case is that one of the data sets must be vector and the other raster. The zonal functions can be exploited which essentially enable statistical information to be computed from raster data and stored as an attribute in the vector data. Here the assumption is that the vector data is the reference or ground truth information whereas the raster data is the derived or interpreted information. Majority count function can be used to establish which of the pixels are the majority within a given polygon. This is then compared with the attribute class of the vector polygon to establish whether they represent the same class.

Within the context of this study, the following inferences can be made for the interpretation, detection and prediction modules as shown in tables 5-1, 5-2 and 5-3 respectively.

a) For the interpretation module:

Reference data (land use category)	Majority –Count	Conclusion
Developed	Developed	Land use identification ok.
Developed	Reserved	Interpretation error
Reserved	Reserved	Land use identification ok.
Reserved	Developed	Change/interpretation error

Table 5-1: Assessment of extracted developed and reserved areas based on polygon-pixel count algorithm.

In this scenario, the assumption is that a developed area will remain developed, whereas the transition of a reserved to a developed area is a possibility and therefore disagreement could either imply that change has taken place or an interpretation error occurred (see row 4). On the other hand the chances of a developed area reverting to developed is considered highly unlikely as flagged in row 3.

b) For the detection of unplanned developments module:

Reference data (land use category)	Majority –Count	Conclusion
Planned developments	Planned developments	Land use detection ok.
Planned developments	Reserved	Detection error.
Planned developments	Unplanned developments	Detection error.
Reserved	Reserved	Land use detection ok
Reserved	Planned developments	Change/Detection error
Reserved	Unplanned developments	Change/Detection error
Unplanned developments	Unplanned developments	Land use detection ok.
Unplanned developments	Planned developments	Detection error
Unplanned developments	Reserved	Detection error

Table 5-2: Assessment of detected unplanned developments based on polygon-pixel count

In the evaluation of the detection of unplanned developments, the idea is to prove that what has been detected is a reflection of the reality. There are three main scenarios which can be deduced from this table, first the straightforward ones, where the reference data and the majority count are in agreement i.e. correct detection of planned development, reserved and unplanned development areas (see rows 1, 4 and 7), secondly, where there are two possibilities i.e. either change has occurred or the disagreement between the reference data and the majority-count results could be viewed as an error. In this case reserved areas could have been converted into either planned or unplanned developments or no change may have taken place (see rows 5 and 6). Thirdly a detection error will be flagged, because the assumption is that the transition from planned developments to unplanned or vice versa is highly unlikely and this is also valid for the transition from planned or unplanned developments to reserved areas (see rows 2, 3, 8 and 9).

Evidently, in addition to being an accuracy indicator, information pertaining to change can also be deduced. Similar studies integrating polygon and raster based information for change detection have been reported e.g. in Westmoreland and Stow [1992], Dowman [1998], etc.

c) For the prediction of the extension of unplanned developments

Reference data (land use category)	Majority –Count	Conclusion
Planned developments	Very likely	Prediction error
Planned developments	Likely	Prediction error.
Planned developments	Maybe Unlikely	Prediction ok.
Planned developments	Unlikely	Prediction ok.
Unplanned developments	Very likely	Prediction ok.
Unplanned developments	Likely	Prediction ok.
Unplanned developments	Maybe Unlikely	Prediction error
Unplanned developments	Unlikely	Prediction error

Table 5-3: Assessment of the prediction model results on the extension of unplanned developments based on polygon-pixel count

This table shows the deductions accruing from comparing reference data with the predicted information on the extension of unplanned developments. Here the categorization of the



possible extension of unplanned developments is based on a fuzzy scale as explained in section 4.4 namely from very likely to unlikely, so this should be understood in context of unplanned developments. Hence, here the evaluation is meant to establish how well the prediction model worked and therefore precaution must be exercised in making deductions. For the purpose of this study, there are two straightforward scenarios where the model can be assumed to work, namely very likely and likely unplanned developments (see rows 5 and 6) and maybe unlikely and unlikely unplanned developments which correspond to planned developments on the reference data (see rows 3 and 4). On the other hand, a prediction error is assumed to occur if the modeled results show very likely and likely unplanned developments, whereas the reference data depicts planned developments (see rows 1 and 2). The same case applies to the prediction results showing maybe unlikely and unlikely unplanned developments, when in actual sense they are unplanned developments according to the reference data.

### 5.3.3 Kappa-Index

Within the framework of image interpretation, the kappa index can be viewed as a measure of performance of a classification relative to the reference data. It is more rigorous than the other indices as it takes into account all cells in an error matrix as well as both errors of commission and omission. If the two images are in perfect agreement (perfect correlation) then the kappa index yields a value of 1, on the other hand, if they are completely different (no correlation) this results in a value of 0. Thus it is evident that, the kappa index can be used both as an accuracy measure as well as a change indicator, whereby if the phenomena under investigation is time independent then the correlation could be purely interpreted as an accuracy measure. On the other hand, if the phenomena is time dependent and the reference and interpreted data have some time difference, then less correlation could be attributed to the changes of the phenomena within that time frame. Various studies that have used this index for evaluation purposes have been reported e.g. [Congalton and Mead, 1983, Lorup, 2000, etc].

It is computed as:

$$k = \frac{\text{Observed accuracy} - \text{chance agreement}}{1 - \text{Chance agreement}} \quad (5-1)$$

where:-

*Observed accuracy*: is the a measure of the agreement between the reference data and the automatic classifier,

*Chance agreement*: is a measure of the agreement between the reference data and the random classifier.

There are two considerations in using this index, namely the mode of distribution of the reference points and the samples to employ. As far as the distribution of the reference points is concerned, this could be randomly (no rules for point distribution), stratified random (number of points distributed according to the number of classes in the thematic layer), and equalized (where each class will have an equal number of random points) distributed.

On the other hand, the choice of samples to use include:

● Training samples only:

The pixels in the training samples are compared with the reference ground truth data to determine the accuracy. The assumption is that the training samples are randomly distributed in the scene which then implies that they are representative. However, this is not always the case since the analyst is biased and selects training areas which he is conversant with and hence a higher accuracy is achieved as expected but not quite a representative measure. Furthermore, this is only relevant if classification scheme adopted is that of supervised and hence this criteria does not fit in within the framework of this study.

● Other areas except training samples:

This is more rigorous as the one based on the training samples only. However, the problem is in determining how many pixels in each test site to use and it requires extra or additional ground truth data. In most cases the selection of the test sites is selected using a random number generator to eliminate biases, in which case the points could be randomly, random stratified or equally distributed for the thematic classes to be verified. Again this criteria assumes that some training areas have been used and therefore supervised classification employed and hence not applicable in this study.

● Every Pixel:

Here every pixel is compared with its corresponding pixel or location on the reference data and an accuracy assessment based on this comparison. The implication here is that there is need for procedures to identify and compare every pixel in the reference data with the interpreted image. The disadvantage is that, it is more computation demanding and it defeats the purpose of automatic image interpretation.

Within the framework of this study, the evaluation is based on two classes in the case of image interpretation i.e. developed and reserved areas, additional class of unplanned developments for the detection module and four classes for the prediction module. This in addition to the available reference data determine the choice of the number of points and the mode of distribution. The testing phase (in the next chapter 6) gives a detailed description on the implementation based on real data.

#### 5.4 Comparison of the Evaluation Indices

Table 5-4 summarizes some characteristics that could be used in the selection of the index to use based on the discussion in section 5.3.

Index/Criteria	Computation demands	Reference data supported	Communication mode
Visual Comparison	Very minimal	Vector/Raster	Visual
Polygon-pixel count	Low	Vector	Quantitative
Kappa-Index	More intensive	Vector/Raster	Quantitative

Table 5-4: Evaluation Indices Comparison

In developing countries, there are drawbacks associated with obtaining ground truth data and these include factors such as finances, security reasons, i.e. some areas are classified and hence obtaining high resolution data e.g. aerial photographs requires clearing by the highest authority. Moreover, field checks are hampered by unfriendly and insecurity conditions since most of these areas are also crime zones, lack of capacity building, etc. This is quite critical since planners should base their decisions on accurate and informed data, and hence mechanism for consistently checking data derived from remotely sensed sources can not be underemphasized.

*The evaluation mechanisms employed in this study which include namely visual comparison, polygon-pixel count and kappa index, have been discussed, detailing the reference data requirements and the determination of the accuracy measures. For planning purposes both qualitative and quantitative measures are useful indications of the quality of the products as well as transition rates of reserved areas to either planned or unplanned developments.*

## **PART III :TESTS AND FINAL REMARKS**

## CHAPTER 6

### PROTOTYPE EXPERIMENTS AND RESULTS

#### 6.1 Overview

The testing of the concept developed in this study is treated in this chapter. Most local governments operate within constrained budgets, and hence with this background, the selection of techniques and tools should be based on factors such as cost-effectiveness and adaptivity to the conditions of the developing countries in terms of timeliness and information content. Specifically, the potential of using remotely sensed data i.e. enhanced Landsat and SPOT images as an information source for discriminating between developed and reserved areas has been exploited. Further, the integration of this information with planning data for purposes of detecting unplanned developments has been tested. Once this phenomena has been identified and detected, there is need for a mechanism to monitor their tendencies and this possibility has also been explored.

#### 6.2 Test Sites and Data

##### Test Sites

Two test sites have been used in this study, namely the Hannover EXPO region was employed for the detection of unplanned developments due to problems associated with obtaining such data from developing countries. Between the periods 1995 and 2000 this region has experienced rapid changes. For the purpose of this study, data sets both planning and remotely sensed were readily available and used to replicate a scenario in developing countries. Figure 6-1 shows the location of this study area from a multispectral 1995 Landsat image.

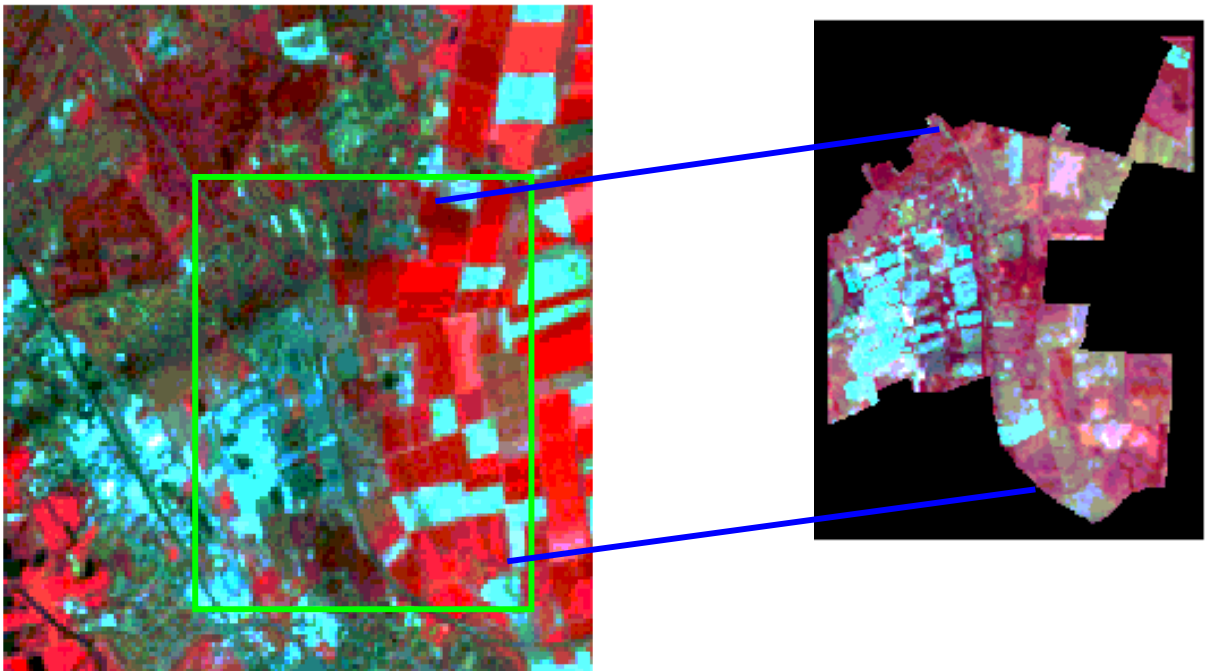

Fig. 6-1: Hannover Study Site

On the other hand, existing information on unplanned developments and ancillary data, from Dar-esalaam, Tanzania formed a good basis for monitoring purposes. Figure 6-2 shows this study site, taken from a multispectral SPOT image of 1998.

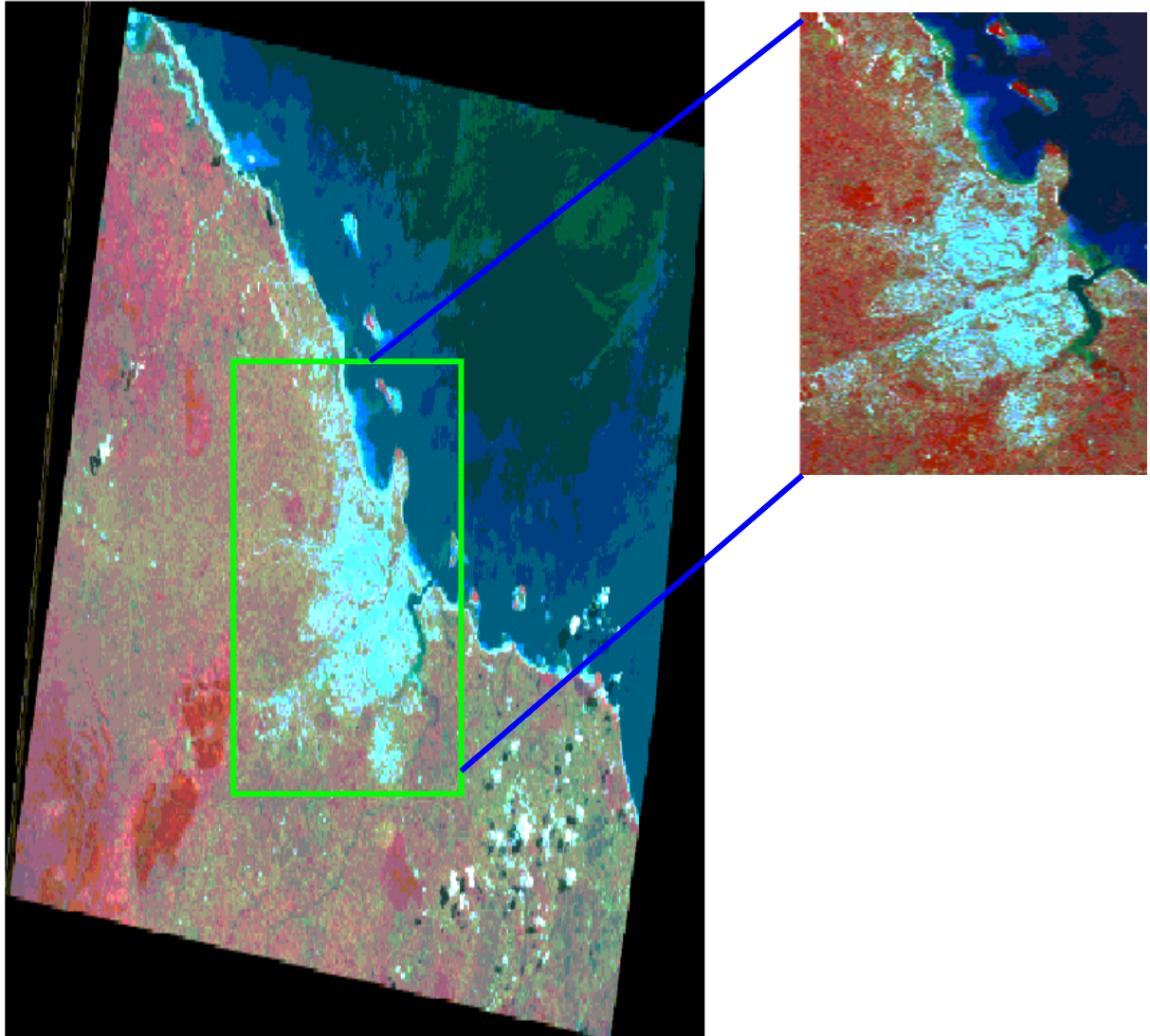

Fig. 6-2: Dar-esalaam Study Site

#### Data Sets

For the detection of unplanned developments, the following data sets for the Expo Region in Hannover were employed:-

Raster based:

- 1:40,000, 1995 and 1998 Color aerial images scanned at 1m resolution
- Landsat TM 1995 (multispectral, 30m resolution)
- Landsat 7 TM 2000 (multispectral, 30m resolution and panchromatic, 15m resolution)

Vector based:

- Building plans which show among other information the extent and permitted type of use.

For the monitoring of trends of unplanned developments, data from Dar-esalaam, Tanzania was used. These comprised of:

Raster based:

- SPOT multispectral 1998 (20m resolution)
- SPOT panchromatic 1998 (10m resolution)

Vector based:

- Land use 1992 showing among other information unplanned developments.
- Infrastructure 1992
- Hydrology 1992
- Digital terrain model
- Population information

### 6.3 Pre-processing

The integration of the various data sets necessitates prior pre-preparation. Within the framework of this study, this entailed co-registration, defining areas of interests through zoning, spatial enhancement through fusion, and digitizing the vector data through visual interpretation.

The following section expounds on these pre-processes:

Co-registration

- Co-registration of the data sets is a pre-requisite to subsequent integration. For the detection of unplanned developments, all the Hannover data sets were co-registered i.e. the aerial images and Landsat images. Further, the Dar-esalaam data sets were also co-registered to enable trend modeling to be conducted, namely the SPOT XS and SPOT Panchromatic images with the vector based information. The second order polynomial warping method was employed for both the two study sites since they are relatively small with minimal variations in elevation.

Data Fusion

- The absence of high resolution multispectral image for urban studies, necessitated the fusion of a panchromatic channel having a higher spatial resolution with the multi-band image to increase the readability of urban structures. In this regard, a 10m panchromatic channel was obtained from the 1995 color aerial photograph. Specifically, it was initially resampled to 10m and the resulting image subjected to an Intensity Hue Saturation Transformation, from where the Intensity channel was fused with the Landsat TM 1995 using the principal component algorithm. The study area was then zoned using the vector layer of the building plans.

- Also the Landsat 7, 2000 (pan and multispectral) datasets were fused to generate a 10m multispectral image showing the status of development in a span of 5 years. This necessitated, resampling of the Landsat 7 panchromatic channel to 10m and using it as a reference to generate a 10m multispectral image so as to enable comparison with the 1995 data sets. The study area was also limited to that covered by the building plans.
- The Dar-esalaam data sets were also combined namely the multispectral and panchromatic to generate an enhanced 10m multispectral image.

#### Manual Interpretation

- A GIS vector layer showing the various land uses was generated from the 1995 color aerial photograph through visual interpretation and digitizing.
- The different building plans covering the area of study were used in combination with the 1998 color aerial photograph to extract a vector layer showing the extent and type of the permitted urban land uses i.e. zoned planned land uses. For the purpose of this study, the land uses were aggregated into two namely developed and reserved areas.
- The Dar-esalaam land use map was manipulated to show unplanned developments planned developments and reserved areas. This involved aggregating classes to conform with the classification scheme adopted for the study.

### 6.4 Image Interpretation

Within the framework of a rule based image interpretation, this entails essentially first establishing the hypotheses (output classes) which form a basis for the selection and definition of variables, that are in principle problem dependent. These variables are then used as inputs in setting up rules, which consist of hypotheses and conditions. Basically, three images have been interpreted, namely two Landsat scenes (Hannover, Expo region, 1995 and 2000) and a SPOT scene (Dar-esalaam, 1998)

#### 6.4.1 Features Extraction and Labeling

The components of a knowledge base are essentially hypotheses (output classes) and variables (features).

##### Variables

For this study, the guiding principle in the selection and generation of variables is based on the ability to discriminate between built and non-built up areas from the multispectral images. In this regard, the suitability of the variables tested included:

##### Texture Variables

- Texture based on the variance operator were computed with window sizes of 3 x 3, 31 x 31 and 61 x 61. This highlights the structural information within the image. It is evident that the choice of the window or neighborhood is important in the description of the texture information. In general, as the window size increases, the textural information tends to be generalized in addition to increase in the



computation time. Thus, for each of the study site this information is shown in the figures 6-3a(i, ii, iii), 6-4a(i, ii, iii), and 6-5a(i, ii, iii) for the Landsat 1995, 2000 and SPOT 1998 respectively.

#### Edge Density Variables

- The delineation between built and non-built up areas forms the core of this study. Hence 3 x 3, 5 x 5 and 7 x 7 windows high pass filter were tested. As already mentioned in section 3.2.1, this is a linear filter whose sum of the coefficients is one, and has the effect of sharpening high frequency details e.g. edge and urban features while at the same time preserving the average intensity of the original image. It is evident that the high frequency information are pronounced in relation to the low frequency details thus making it easier to distinguish between built and non-built up areas. These can be seen in figures 6-3b(i, ii, iii), 6-4b(i, ii, iii) and 6-5b(i, ii, iii) for the Landsat 1995, 2000, and SPOT 1998 respectively.

#### Normalized Difference Vegetation Index (NDVI) Variables

- For each of the three images an NDVI layer was generated. This facilitates in the discrimination of vegetated and non-vegetated. The outputs for both the Landsats 1995 and 2000 and SPOT 1998 data sets are depicted respectively in figures 6-3c, 6-4c and 6-5c.

#### Unsupervised Classification Variables

- Unsupervised classification layers were generated with 10 clusters and aggregated to 5 classes for both the Landsat images (1995 and 2000) and 20 clusters aggregated to 9 classes for the SPOT Dar-esalaam data (1998), i.e. figures 6-3d, 6-4d and 6-5d respectively. The idea here is to have as few clusters as possible since the desired output consists of two classes namely developed and reserved areas. Furthermore, the heterogeneous nature of an urban environment makes it difficult to spectrally separate between the two classes, hence this was meant to serve as additional evidence in setting up the knowledge base. The clustered images are shown with the various colors representing clusters, some of which are clear distinction of built and non-built up whereas others are a mixture of developed and reserved areas.

It should be noted that, additional features can be used to supplement the already mentioned ones e.g. the spectral channels, the principal component bands, and GIS data, but for the purpose of this study only these four were focused on.

1995 Landsat Image Variables

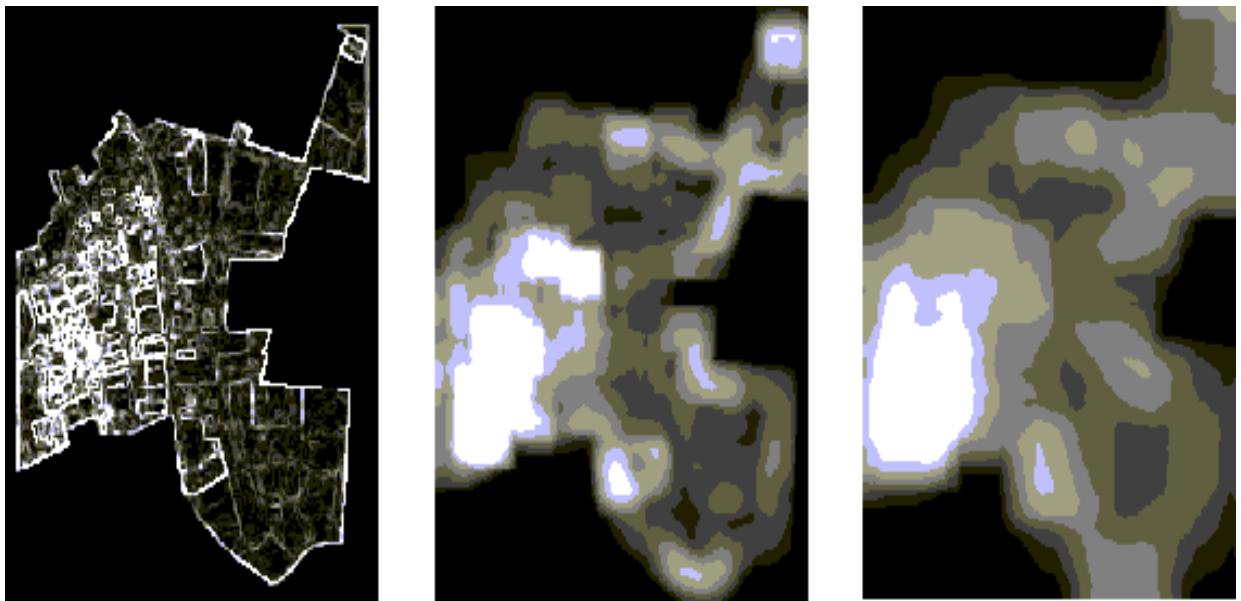

(i) 3 x 3

(ii) 31 x 31

(iii) 61 x 61

Fig. 6-3a: Landsat 1995 Texture Variables

As the window size increases as shown in figures 6-3a (i, ii, iii), it is evident that the discrimination between developed and reserved areas becomes rather subtle due to generalization. The 3 x 3 window size tends to distinguish between the predominantly developed areas and reserved areas. Therefore this image was adopted for the study.

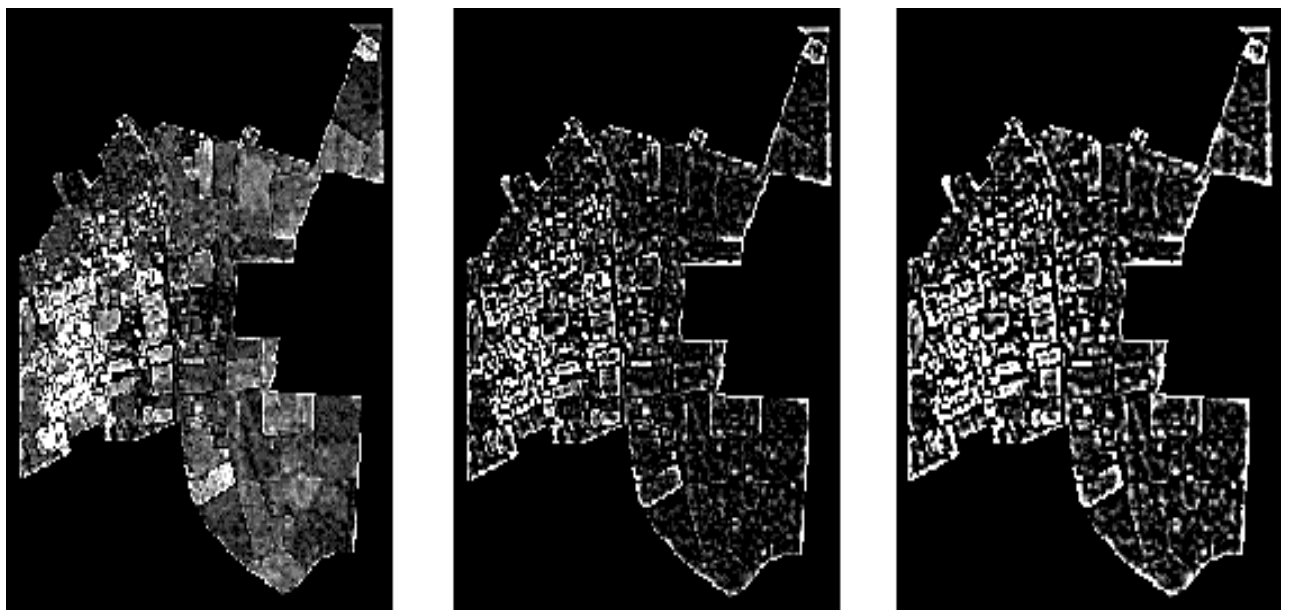

(i) 3 x 3

(ii) 5 x 5

(iii) 7 x 7

Fig.6-3b: 1995 High Edge Variables

Similarly in this case the signal to noise ratio reduces as the window size increases as shown in figures 6-3b (i), (ii) and (iii). The 3 x 3 window size however, is less noisy and the high

frequency components namely developed areas are more pronounced. Hence this image was adopted for the image interpretation.



Fig.6-3c: 1995, NDVI

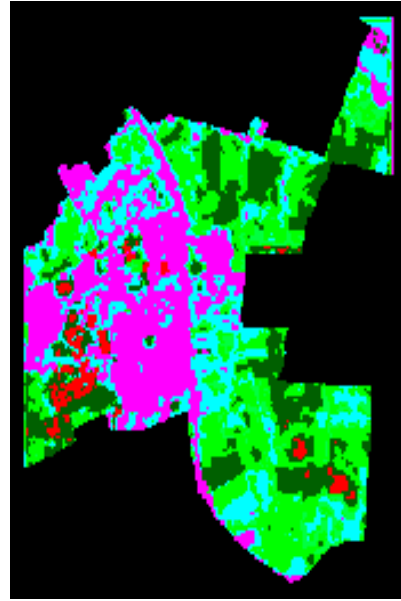

Fig.6-3d: 1995, Clustered layer

Figure 6-3c shows the NDVI image for the Landsat 1995 data. The bright areas are principally the reserved areas, whereas the dull ones are developed areas. Obtaining, an optimum threshold that will completely delineate developed from reserved areas is a challenging task based on only NDVI. Nevertheless, it does provide useful information which has been exploited in the interpretation process.

The unsupervised clustered layer figure 6-3d shows the 5 different clusters for the 1995 image, where Pixel Class\_RC = 1 represents mixed pixels with a larger proportion of developed as opposed to reserved areas, whereas Pixel Class\_RC = 2, Pixel Class\_RC = 3 and Pixel Class\_RC = 4 consist of more reserved areas in comparison to developed areas. Pixel Class\_RC = 5 is purely developed areas. Thus, extracting purely developed and reserved classes based on the spectral information only is not an easy task due to the spectral overlap. Nevertheless, it provides some segmentation information which is useful for the image interpretation.

**Landsat 2000 Image Variables**



(i) 3 x 3



(ii) 31 x 31

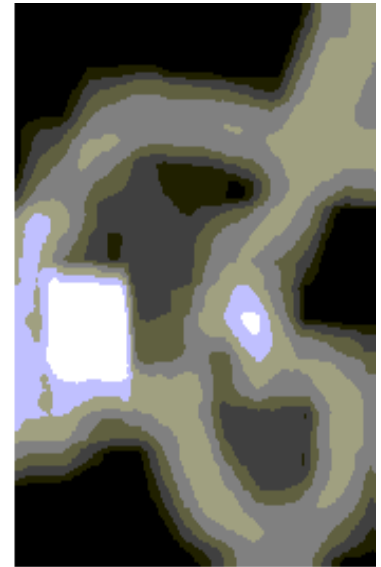

(iii) 61 x 61

Fig.6-4a: Landsat 2000, Texture variables

There is more generalization of the texture information as the window size increases as shown in figures 6-4a (i, ii, iii). For the purpose of this study, the enhancement and localization of the two classes namely developed and reserved areas are of paramount importance, Hence, a small window size is more useful in this case and therefore 3 x 3 image was employed in the image interpretation.



(i) 3 x 3



(ii) 5 x 5



(iii) 7 x 7

Fig. 6-4b: 2000, High Edge Variables

The effect of neighborhood in the enhancement of high frequency component is shown in figures 6-4b (i), (ii) and (iii). The details become less sharp as the neighborhood increases making it difficult to discriminate between the developed and the reserved areas.

Consequently, the minimum window size of 3 x 3 is a better compromise and was adopted for this study.



Fig. 6-4c:2000, NDVI

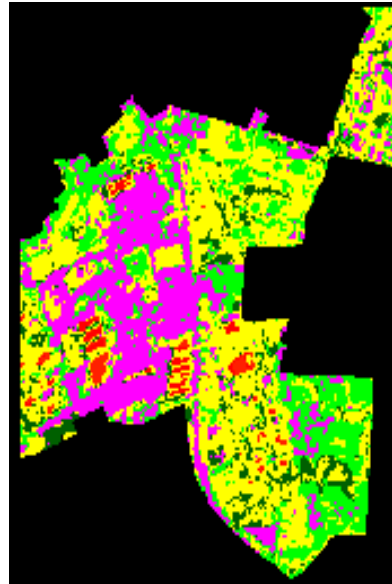
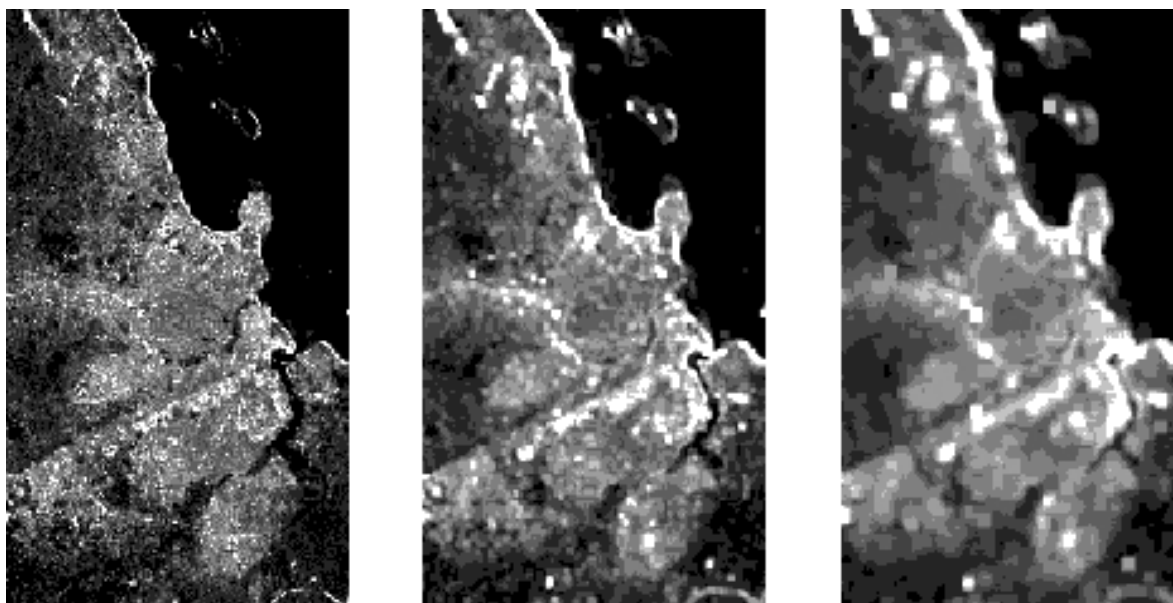

Fig.6-4d:2000,Clustered layer

Figure 6-4c shows the NDVI for the Landsat 2000 image, where the dark areas correspond principally to developed areas whereas the bright ones to the reserved areas. In comparison to the NDVI Landsat 1995, it is evident that a lot of changes have taken place which involve conversion of reserved to developed areas. Similarly, the challenge is to choose a suitable threshold that will enable the two classes to be discriminated. This is not an easy task and therefore this information is employed in combination with the other variables in the interpretation process.

On the other hand figure 6-4d is an unsupervised layer containing 5 aggregated classes of the Landsat 2000 image. In general Pixel Class\_RC = 1, Pixel Class\_RC = 3 and Pixel Class\_RC = 4 represent in pixel proportion more developed areas in comparison to reserved ones, whereas Pixel Class\_RC = 2 has more reserved as opposed to developed areas, and Pixel Class\_RC = 5 corresponds to purely developed areas. Based on only the spectral information, the delineation between the two classes is not feasible. However, this serves as one of the information sources which was exploited in the knowledge based image interpretation process.

**SPOT 1998 Image Variables**



(i) 3 x 3

(ii) 31 x 31

(iii) 61 x 61

Fig. 6-5a: SPOT 1998, Texture Variables

Figures 6-5a (i, ii, iii) show the texture images of the Dar-esalaam, 1998 SPOT image with neighborhood sizes defined by the 3 x 3, 31 x 31 and 61 x 61 windows respectively. The effect of increasing the neighborhood is in principle as explained for the Landsat images whereby there is more generalization and the differences between the two classes becomes difficult to distinguish. Thus for this study the 3 x 3 neighborhood was adopted to avoid loss of information.

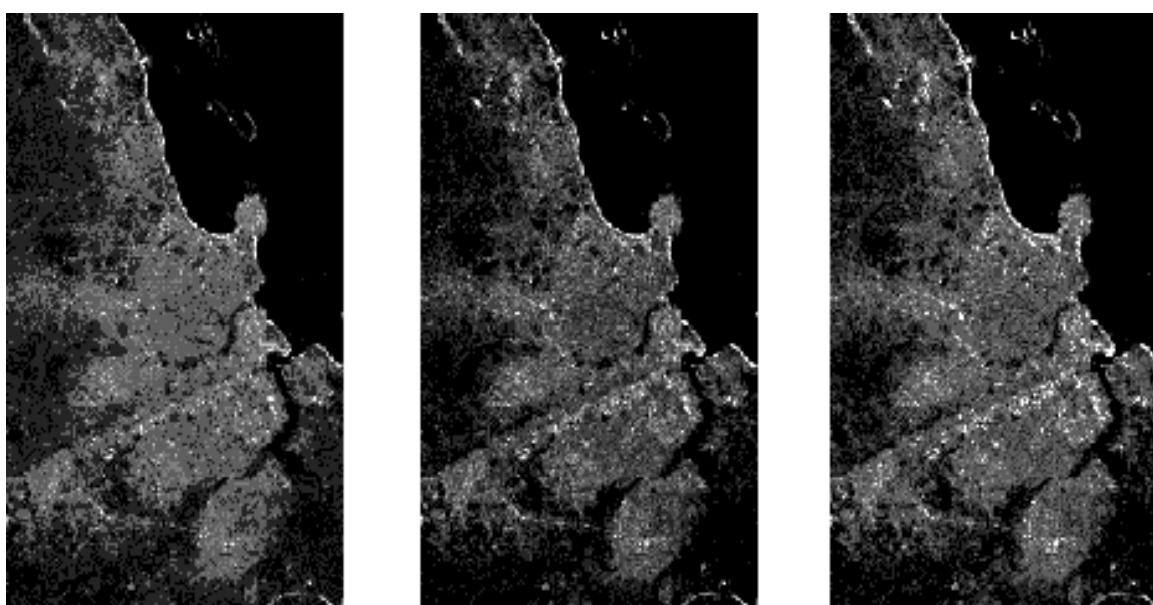

(i) 3 x 3

(ii) 5 x 5

(iii) 7 x 7

Fig. 6-5b: SPOT 1998, High Edge Variables

The high edge variables of the SPOT image with varying window size of 3 x 3, 5 x 5 and 7 x 7 are as shown in figures 6-5b (i, ii, iii) respectively. The signal to noise ratio decreases with



increase of window size thus making it difficult to discriminate between the two classes. Thus, for the purposes of this study minimum window size is preferable.

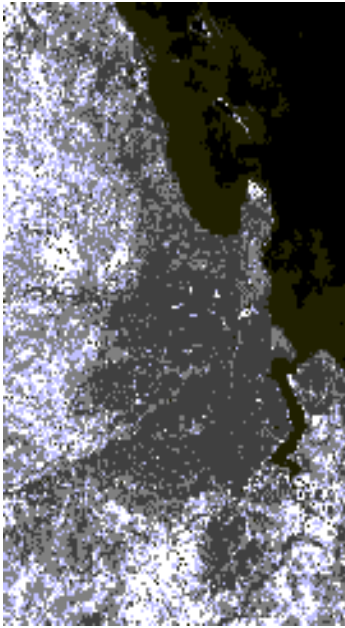

Fig. 6-5c:1998, NDVI

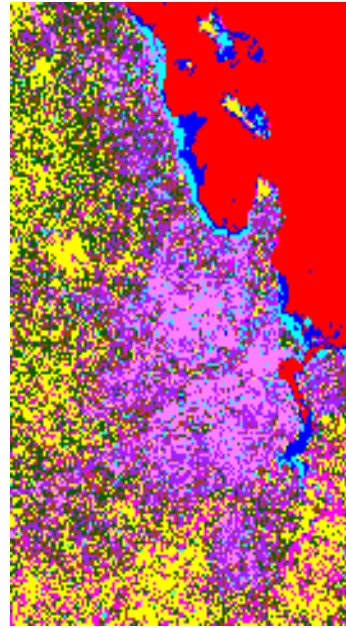

Fig. 6-5d:1998, Clustered Layer

The SPOT 1998, NDVI depicts bright areas which correspond to reserved areas and the dark ones to developed areas. The black areas represent the ocean. This is useful information which when employed in the image interpretation give an indication of sealed and non sealed areas. However, due to the difficulties involved in obtaining a suitable threshold, it can not be use in isolation for this purpose.

The clustered image (figure 6-5d) shows 9 aggregated classes of the SPOT image. Similarly, the difficulties involved in obtaining pure classes based on spectral information alone is evident as already elucidated in chapter 3 ( section 3.2.1). In principle Pixel Class\_RC = 1 and Pixel Class\_RC = 2 correspond to purely reserved areas whereas Pixel Class\_RC = 9 represent developed areas. The other classes are a mixture of the two classes in different proportions specifically, Pixel Class\_RC = 3, Pixel Class\_RC = 4, Pixel Class\_RC = 5, and Pixel Class\_RC = 6, contain more reserved in comparison to developed areas, and Pixel Class\_RC = 7 and Pixel Class\_RC = 8 represent more developed areas as opposed to reserved ones. Thus within the context of this study where the desired classes are developed and reserved, the spectral overlap is inevitable. This information has been used in combination with the other variables namely texture, high edge density, and NDVI in the image interpretation process.

#### 6.4.2 Knowledge-Based Rules

For the interpretation of the three images namely two Hannover Landsat scenes for 1995 and 2000, and the Dar-esalaam, 1998 SPOT scene, the features generated were used to form the rule base. In general, there exists, both global as well as specific rules, whereby within the context of this study, the former refer to the general characterization of developed and reserved areas as perceived from the texture, edge density, NDVI, spectral channels and principal components, whereas specific rules are scene oriented and deal with the unique and peculiar occurrences per scene. This also applies to the two Hannover scenes acquired at two

different epochs. The results of histogram matching of the two images are illustrated in the figures below highlight this issue.



Fig. 6-6a, 1995, Landsat image before histogram matching



Fig. 6-6b: Landsat 1995 image after histogram matching

Figure 6-6a shows the original 1995, Landsat image, whereas figure 6-6b is the corresponding histogram matched image. A visual comparison of the two images show that some areas have been enhanced at the expense of others. This can be attributed to the differences in contrasts between the 2000 and the 1995 image as a result of the seasonal variations in which the images were acquired. The 1995 image was acquired at the beginning of April whereas the 2000 image at the beginning of May. This is in addition to the major changes that have taken place in this region.



Fig. 6-7a, 2000, Landsat image before histogram matching



Fig. 6-7b: Landsat 2000 image after histogram matching

A more or less similar conclusion can be arrived at here, where figure 6-7a is the original 2000 image before histogram matching whereas figure 6-7b is the 2000 image after changing



its histogram to match that of the 1995 image. In this case, however, the new developed areas are in principal enhanced and they appear very bright on the image whereas the previously developed areas are suppressed and they are difficult even to visualize or to distinguish from the reserved areas. Nevertheless, this image has been used together with the original 1995 Landsat image, figure 6-6a, to test the possibility of using same values based on the image primitives in the discrimination of the developed and reserved areas. Figure 6-8 shows the general interpretation process with the two levels namely global and domain specific. At the global level, the rules are general in nature, whereas at the domain or image scene level, rules are more specific, e.g. the attempt is to assign real values on the basis of the image under interpretation. For instance for a developed area low NDVI could mean less than 0.0 in one image whereas for another, NDVI less than 0.3 .

The following sections elucidate on these two levels of knowledge, starting with the global cases and then the domain specific ones.

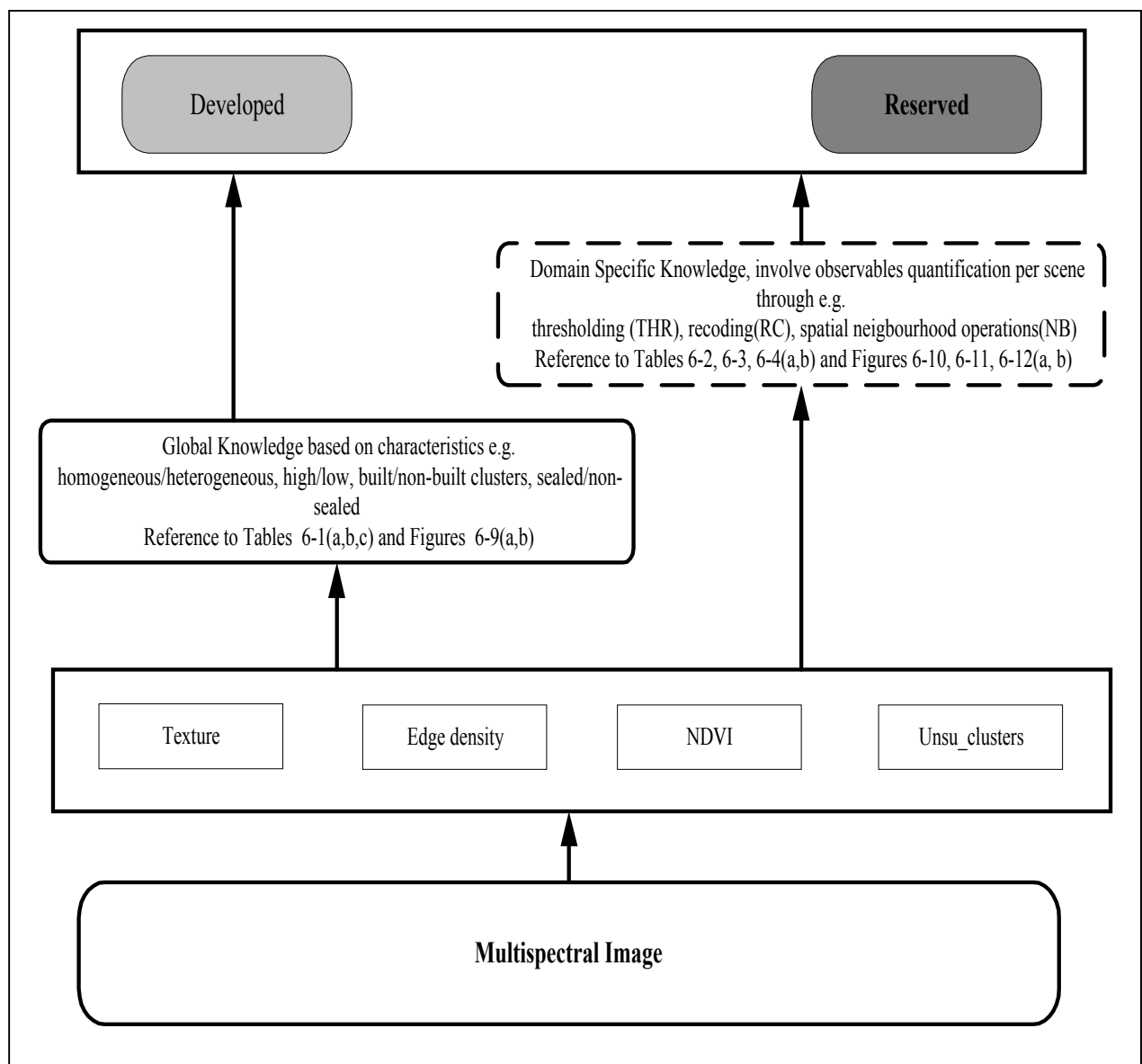

Fig. 6-8: Multispectral Image Interpretation Process.

a) Global Knowledge Base Rules

Here four test cases were conducted and the values used for the extraction of the two classes based on the three image primitives namely texture, edge density and NDVI are as shown in table 6-1. The two Landsat images namely the 1995 and the histogram matched 2000 are used as the inputs.

HYPOTHESES	CONDITIONS
Developed	Texture_THR > 0.5 Edge Density_THR > 10 NDVI_THR <= 0.7
Reserved	Texture_THR <= 0.5 Edge Density_THR <= 10 NDVI_THR > 0.7

Table 6-1a: Global Knowledge Rules

The following are the combinations used for both the images based on the values contained in the table 6-1a. :

- Case 1: NDVI and Edge Density
- Case 2: Edge Density and Texture
- Case 3: NDVI, Edge Density and Texture
- Case 4: NDVI, Edge Density, Texture and Unsupervised Classification

For case 4, the tables below contains the rules used, whereby table 6-1b shows the general rules pertaining to the developed areas, and table 6-1c is for the reserved areas.

In general, the labeling of the hypotheses is an indication of the hierarchy level within the decision tree, i.e. hypotheses H1 precedes hypotheses H2, etc

Developed Areas, Rule Base	
Hypotheses THEN( )	Condition IF ( )
H2	NDVI_THR <= 0.7 AND Edge Density_THR > 10 AND Texture_THR > 0.5 OR Pixel Class_RC = 1 AND NDVI_THR <= 0.7
H4	Pixel Class_RC = 5 OR Pixel Class_RC = 1 AND NDVI_THR >= 0.7 AND Texture_THR > 0.5

Table 6-1b: General Rule base for the developed areas

In principal the two hypotheses namely H2 and H4 which when aggregated translated to developed areas were evaluated based on the conditions as shown in the table. As a general rule of thumb, built up areas are associated with low NDVI values, high edge density values and texture values. Of the 5 clusters derived from the unsupervised classification, pixels whose classes were assigned 1 and 5 represented predominantly developed areas. The structural configuration for the extraction of developed areas is depicted by the decision tree shown in figure 6-9a.

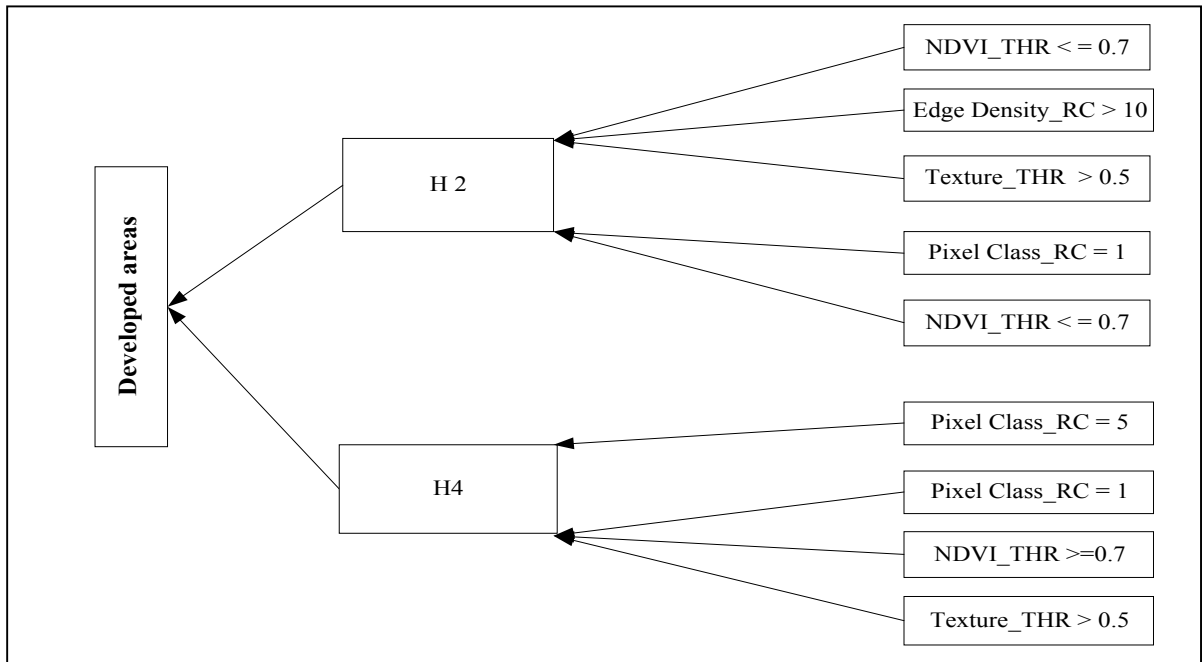

Fig. 6-9a: The Decision Tree for the general rule base of the developed areas

The four hypotheses namely H1, H3, H5 and H6 represent reserved areas. On the contrary, high NDVI values, low edge density and texture values are primarily associated with reserved or non-built up areas with some exceptional cases where e.g. low NDVI values also characterize reserved areas, for instance bare ground (see H1). The unsupervised classes assigned 1,2,3 and 4 were employed in the extraction of reserved areas together with the other primitives. The structural configuration of these rules are shown in figure 6-9b.

Reserved Areas, Rule Base	
Hypotheses THEN( )	Condition IF ( )
H1	Pixel Class_RC = 2 AND NDVI_THR <= 0.7
H3	Pixel Class_RC = 4 AND NDVI_THR >= 0.7
H5	Pixel Class_RC = 1 AND NDVI_THR >= 0.7 AND Texture_THR < 0.5
H6	NDVI_THR > 0.7 AND Edge Density_THR <= 10 AND Texture_THR < 0.5 AND Pixel Class_RC = 2 OR Pixel Class_RC = 2 OR Pixel Class_RC = 3

Table 6-1c: General Rule base for the reserved areas

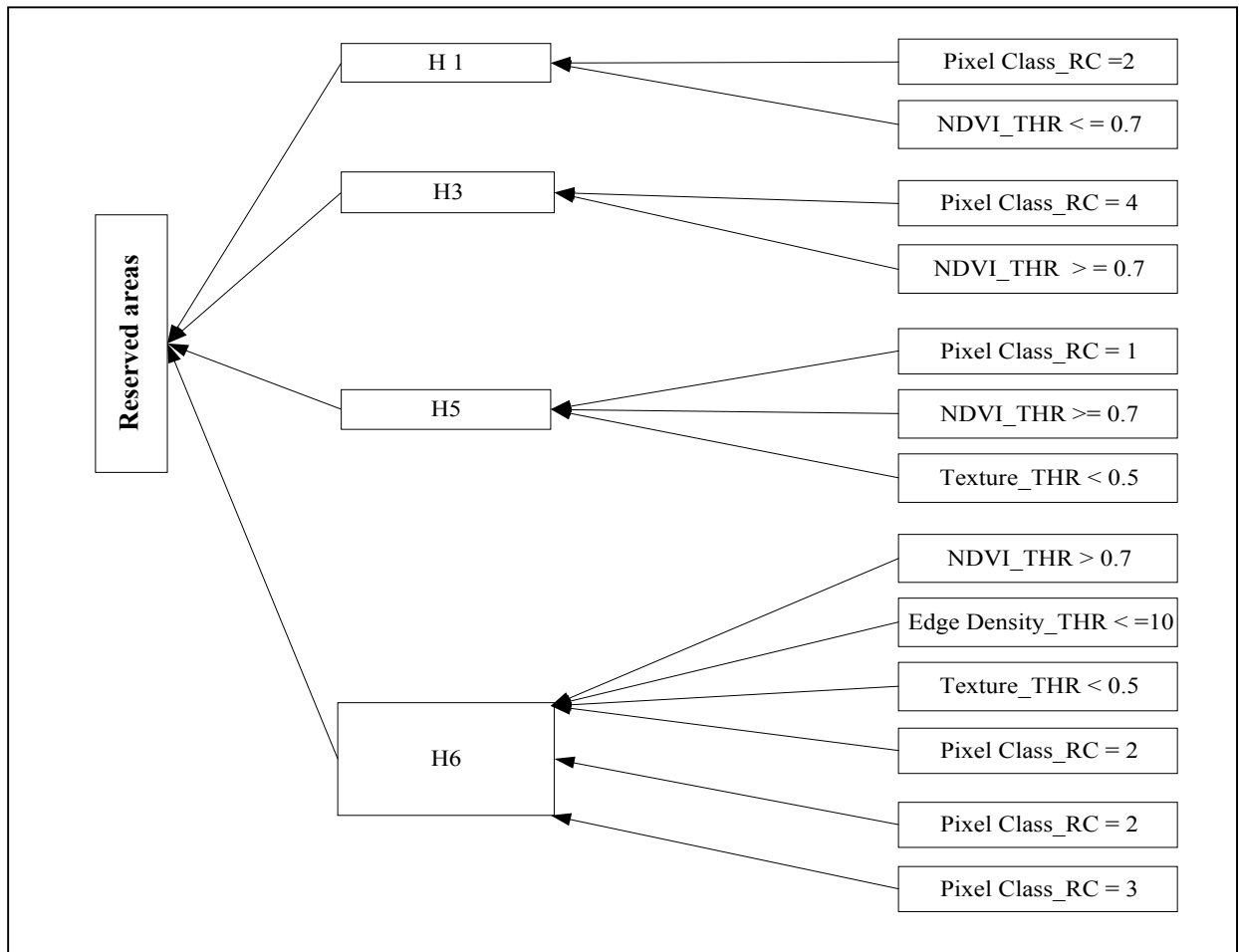

Fig. 6-9b: The Decision Tree for the general rule base of the reserved areas

The following section deals with the establishing of the rules for the interpretation of the three images namely the two Hannover data sets and the Dar-esalaam data set.

b) Domain Specific Knowledge Rule Base

Thus for the interpretation of the individual scenes, specific knowledge which involves extracting the observables namely the developed and reserved areas entails further processes e.g. thresholding (THR), recoding(RC), spatial neighborhood operations (NB). Due to the fact that the expert classifier is pixel based, contextual information was introduced by means of neighborhood operation, specifically on the unsupervised classified layer with an aim of identifying contiguous group of pixels assigned to the same thematic class [Erdas Imagine 8.4, 1999]. The rule bases highlighting the hypotheses and their corresponding conditions based on the extracted and labeled information employed for each scene namely the two Hannover scenes i.e.1995 Landsat, 2000Landsat and the Dar-esalaam scene 1998 SPOT, are contained in tables 6-2(a,b), 6-3(a,b) and 6-4(a,b) respectively, where the (a) part tables pertains to the developed area whereas the (b) part tables are for the reserved areas. The explicit hierarchical configuration of the rules are shown by the decision trees which are represented in figures 6-10(a,b), 6-11(a,b), 6-12(a,b). The (a) part of the decision tree contains the rules used for extracting developed areas, whereas the (b) part is used for the reserved areas.

1995, Developed Areas, Rule Base	
Hypotheses THEN( )	Condition IF ( )
H9	Pixel Class_RC = 3 AND NDVI_THR > 0.5 AND Texture_THR > 1
H12	NDVI_THR < 0.8 AND Edge Density_THR > 0 AND Pixel Class_RC != 2 OR Edge Density_THR > 18 AND Edge Density_THR < 40 AND Pixel Class_RC != 2 OR NDVI_THR < 1 AND Pixel Class_RC = 1 OR Pixel Class_RC = 2 AND NDVI_THR < 0.8 OR Pixel Class_RC = 4 AND NDVI_THR < 0.8

Table 6-2a: Hannover Landsat 1995, Rule base for the Developed Areas

Table 6-2a contains the set of rules used for the interpretation of the developed areas from the 1995 Hannover Landsat TM image. Both high and low NDVI values were characteristic of developed areas as shown by the hypotheses H9 and Hypotheses H12. Typical of high NDVI values regions are open parking areas having both pavement and some vegetation e.g. grass or some bushes. Another case, is some building roofs. This therefore does explain the inconsistencies and the difficulties associated with dealing with only one threshold. Figure 6-10a, is the corresponding decision tree structure.

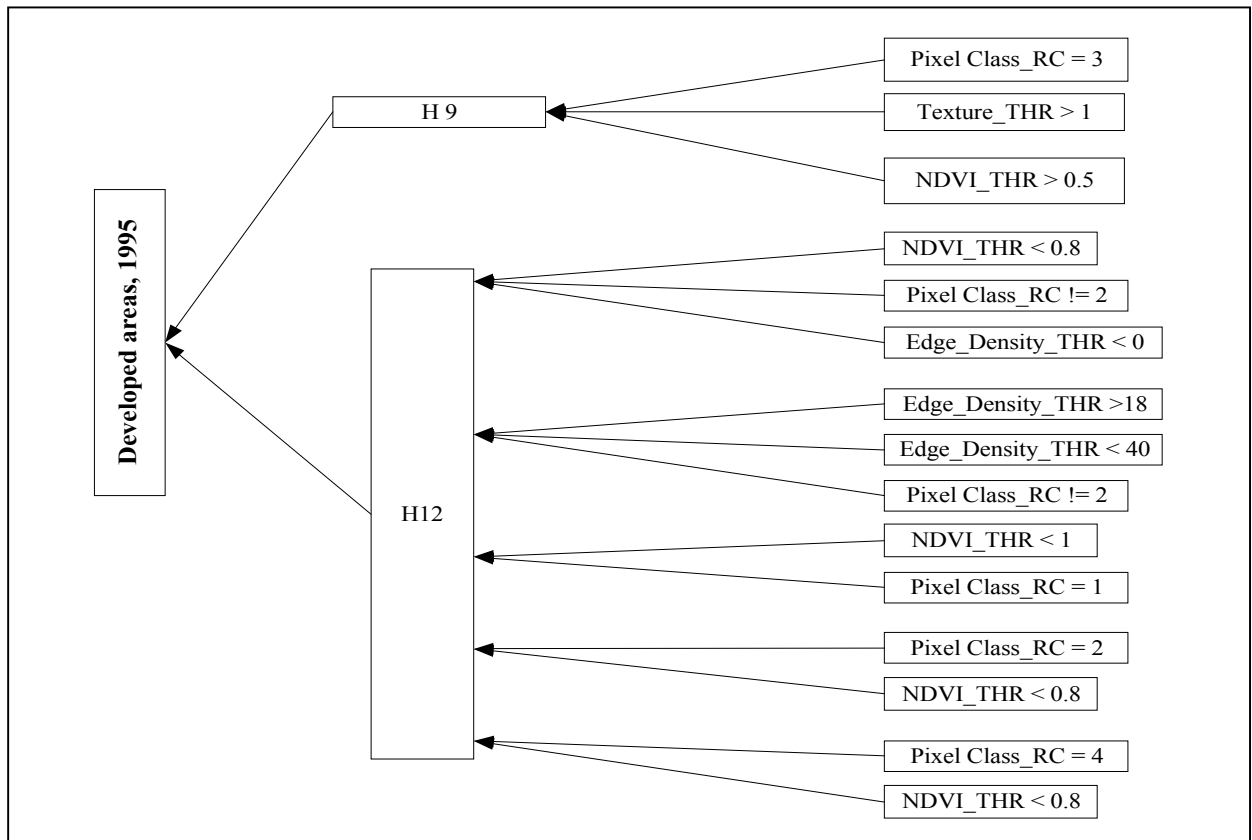

Fig. 6-10a: The Decision Tree for the 1995, Hannover Developed Areas

1995, Reserved Areas, Rule Base	
Hypotheses THEN( )	Condition IF ( )
H1	NDVI_THR <= 0.8 AND Edge Density_THR > 0 AND Pixel Class_RC_NB = 21
H2	NDVI_THR <= 0.8 AND Edge Density_THR > 0 AND Pixel Class_RC_NB = 11
H3	NDVI_THR <= 0.8 AND Pixel Class_RC = 3
H4	NDVI_THR > 0.8 AND Pixel Class_RC = 4
H5	NDVI_THR <= 0.8 AND Edge Density_THR > 0 AND Pixel Class_RC_NB = 42
H6	NDVI_THR <= 0.8 AND Edge Density_THR > 0 AND Pixel Class_RC_NB = 43
H7	NDVI_THR <= 0.8 AND Edge Density_THR > 0 AND Pixel Class_RC_NB = 41
H8	NDVI_THR > 0.8 AND Pixel Class_RC = 1 OR Texture_THR = 0
H10	NDVI_THR > 0.4 AND Edge Density_THR < 30 AND Pixel Class_RC = 4
H11	NDVI_THR > 0.6 AND Texture_THR < 15 AND Pixel Class_RC = 3
H13	Pixel Class_RC = 1 AND NDVI_THR > 0.7

Table 6-2b: Hannover Landsat 1995, Rule base for the Reserved Areas

The area extent of reserved areas in 1995 is more in comparison to developed areas. This could explain in part the more hypotheses used in their extraction, and in part due to the spectral variability between the developed and the reserved areas as shown in table 6-2b. In this case, neighborhood operations were employed on the unsupervised classified layer to facilitate in the discrimination between developed and reserved areas. For instance, Pixel Class\_RC\_NB = 11 implies that a contiguous group of pixels whose initial thematic class assignment was 1. Here both high and low NDVI as well as Edge Density values were encountered and used in the establishment of the knowledge base. The texture was not varied and was in principal maintained to low values.

Figure 6-10b, shows the decision tree structure of these rule base.

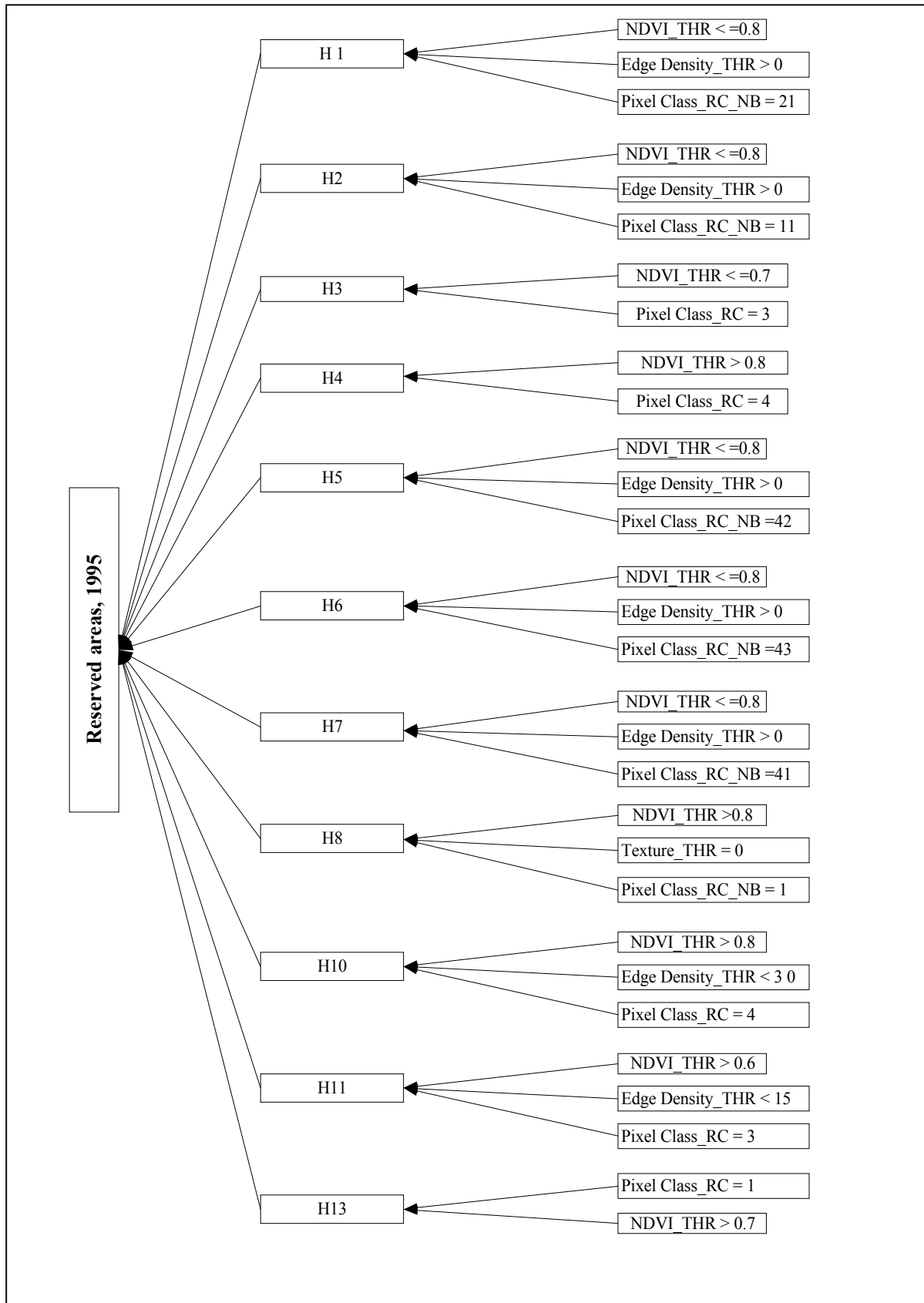

Fig. 6-10b: The Decision Tree for the 1995, Hannover Reserved Areas

2000, Developed Areas, Rule Base	
Hypotheses THEN( )	Condition IF ( )
H1	NDVI_THR < 0 AND Pixel Class_RC = 1
H2	NDVI_THR < 0.25
H4	NDVI_THR < 0 AND Pixel Class = 2
H6	NDVI_THR < 0.05 AND Pixel Class_RC = 4
H7	NDVI_THR < 0 AND Pixel Class = 5
H8	Pixel Class_NB_RC=1

Table 6-3a: Hannover Landsat 2000, Rule base for the Developed Areas

Table 6-3a contains the data set used for the interpretation of the developed areas for the 2000, Hannover Landsat data. A total of 8 hypotheses represented developed areas in comparison to the 1995 image which had 2 hypotheses. In this case, the unsupervised classified layer was used in combination with the NDVI image as shown. Thus edge density image and texture were not employed. Figure 6-11a shows the corresponding decision tree for these rule base.

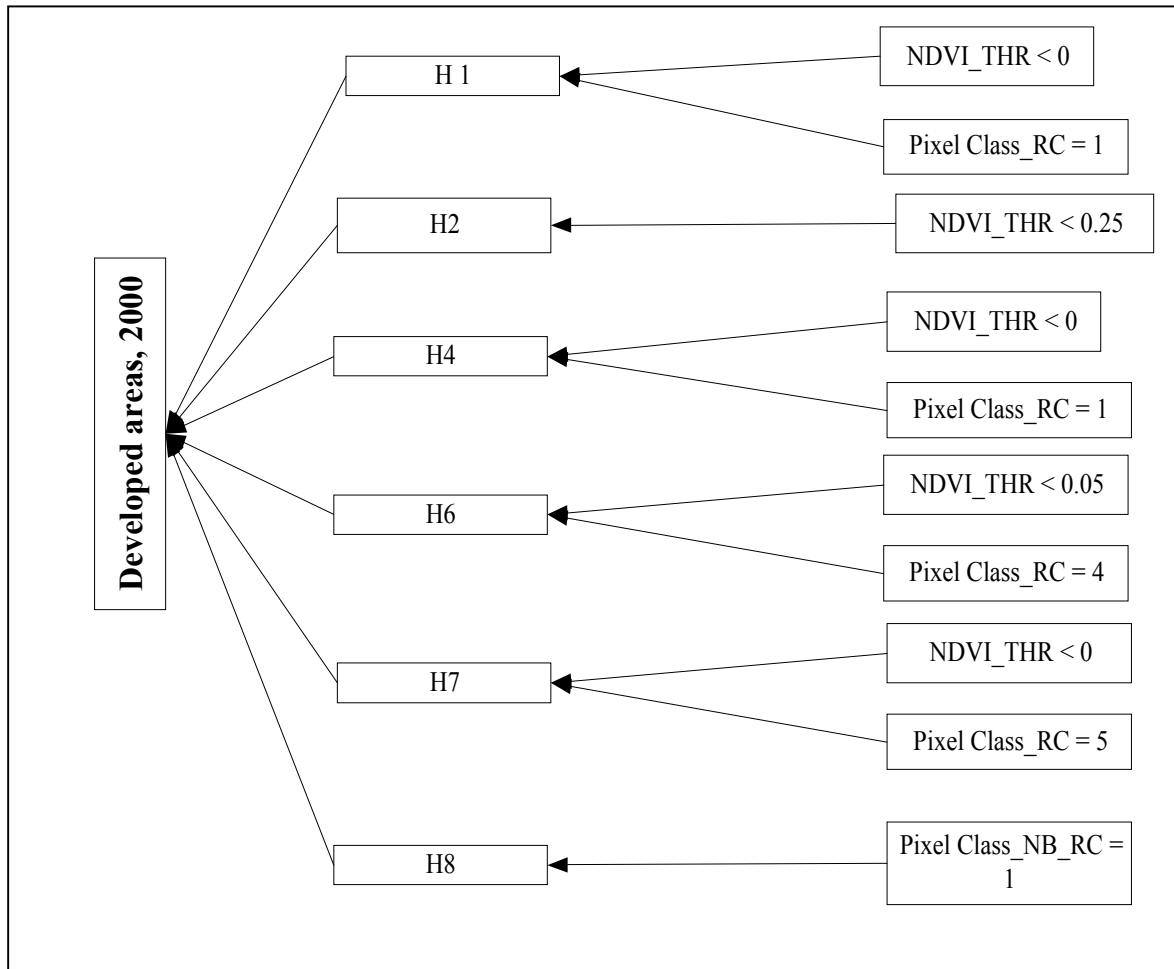

Fig. 6-11a: The Decision Tree for the 2000, Hannover Developed Area



2000, Reserved Areas, Rule Base	
Hypotheses THEN( )	Condition IF ( )
H3	Pixel Class_RC = 3 OR Pixel Class_RC = 4
H5	Pixel Class_RC= 1
H9	NDVI_THR > 0 AND Pixel Class_RC = 3 OR NDVI_THR > 0 AND Pixel Class = 2
H10	Texture_THR < 5 AND Texture_THR != 0 OR Edge Density_THR < 80 AND Edge Density_THR != 0

Table 6-3b: Hannover Landsat 2000, Rule base for the Reserved Areas

In comparison to the developed areas, only four hypotheses were associated with the reserved areas of the Hannover 2000 Landsat image as depicted in table 6-3b. In addition to the unsupervised classified layer and the NDVI, edge density and texture were also used as shown in relation to Hypotheses 10. The corresponding decision tree is shown in figure 6-11b.

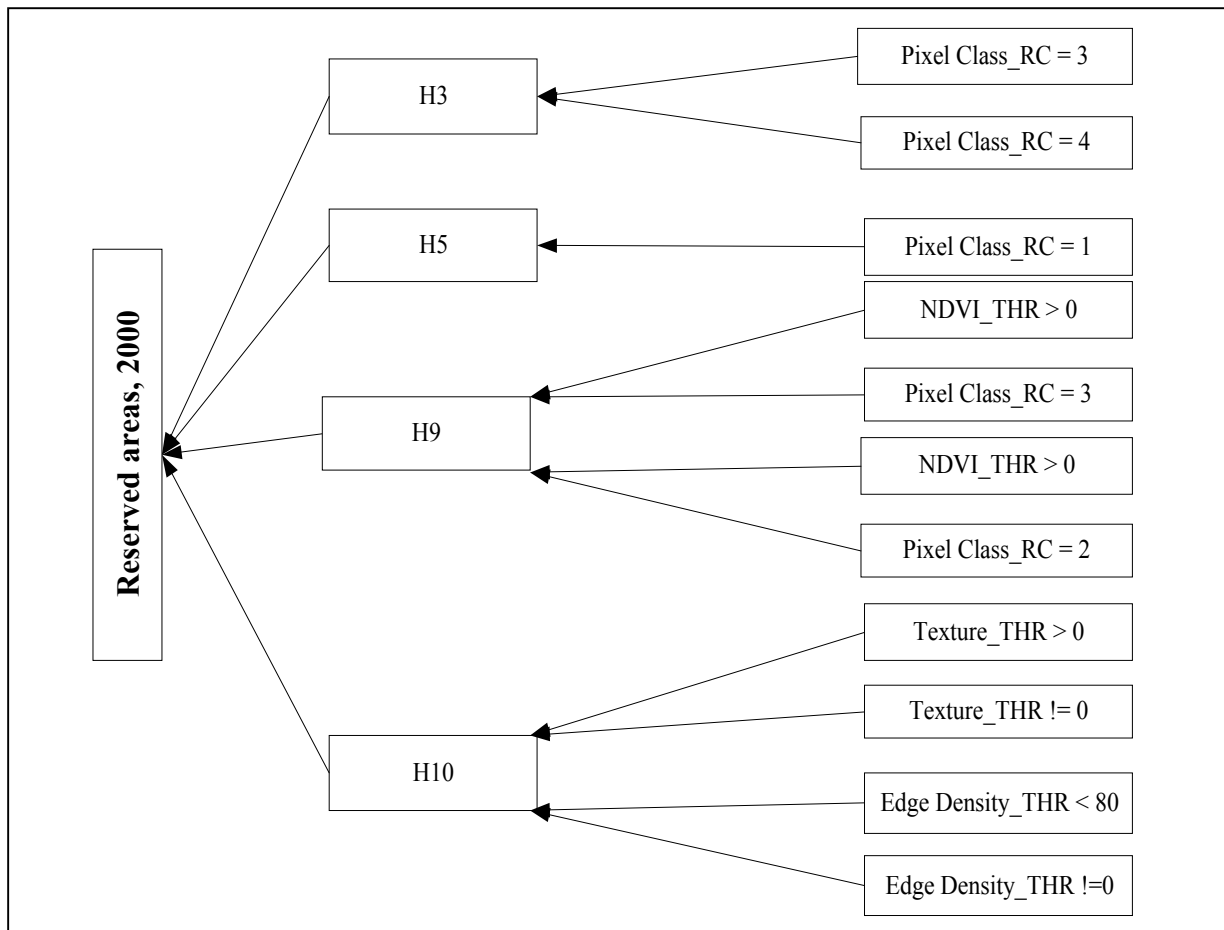

Fig. 6-11b: The Decision Tree for the 2000, Hannover Reserved Areas

1998, Developed Areas, Rule Base	
Hypotheses THEN( )	Condition IF ( )
H2	NDVI_THR < 0 AND Pixel Class_RC = 9 AND Edge Density_THR >= 56 OR Texture_THR > 3 AND Texture_THR < 8 AND Pixel Class_RC = 9
H3	Pixel Class_RC = 8 AND NDVI_THR < 0 AND Edge Density_THR >= 55
H4	Pixel Class_RC = 7 AND NDVI_THR < 0 AND Edge Density_THR >= 55
H8	Pixel Class_RC = 3 AND NDVI_THR < 0

Table 6-4a: Dar-esalaam SPOT 1998, Rule base for the Developed Areas

The developed areas from the Dar-esalaam 1998 SPOT image were extracted based on the above rule base. Specifically, all the features were used with a total of four hypotheses as shown in the table 6-4a. Figure 6-12a shows the explicit hierarchical structure of the rules.

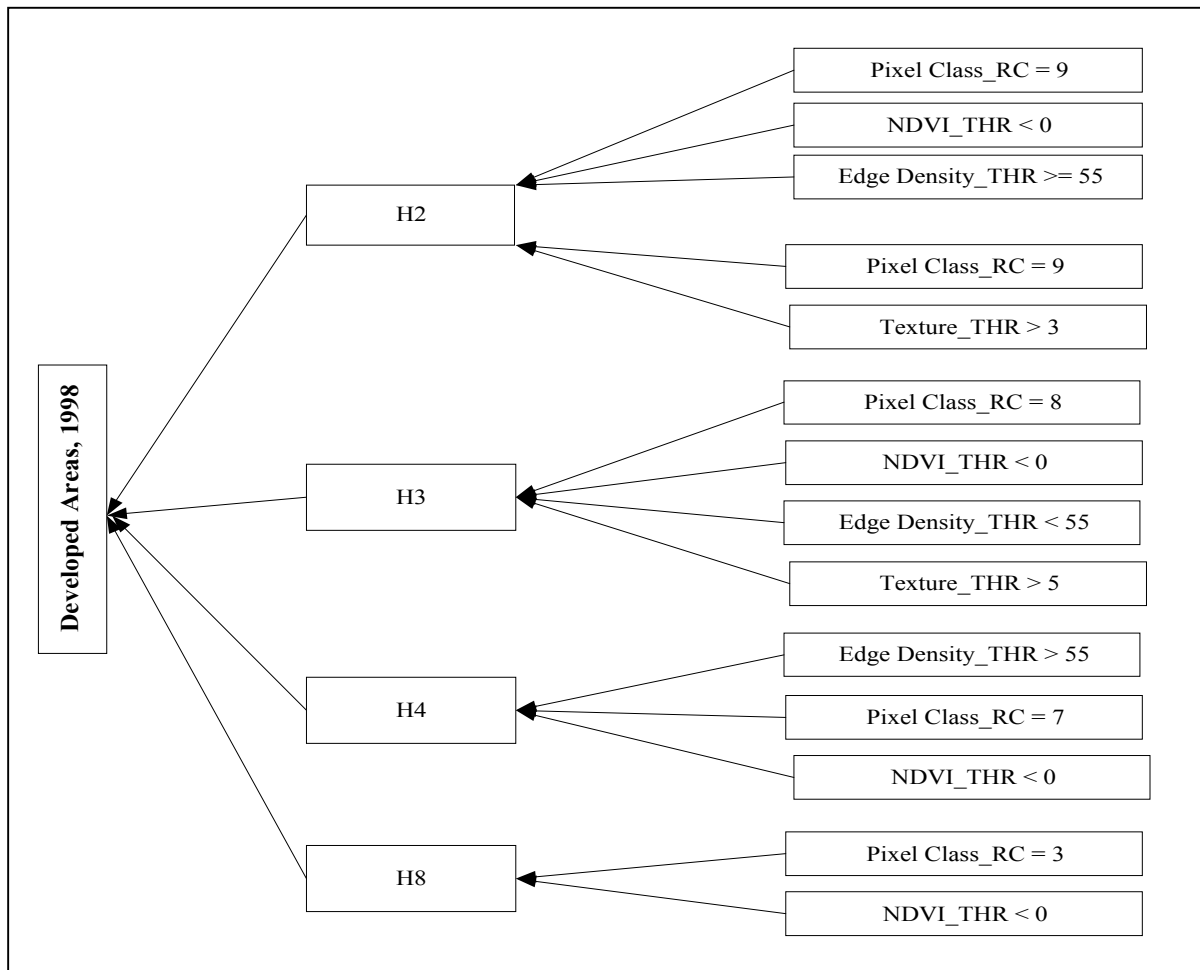

Fig. 6-12a: The Decision Tree for the 1998, Dar-esalaam Developed Area

1998, Reserved Areas, Rule Base	
Hypotheses THEN( )	Condition IF ( )
H1	Pixel Class_RC = 1 OR Pixel Class_RC = 2
H5	Pixel Class_RC= 5 AND NDVI_THR > 0 OR Texture_THR < 5
H6	Pixel Class_RC= 6 AND NDVI_THR > 0 OR Texture_THR < 8
H7	Pixel Class_RC= 0 AND NDVI_THR < 0 OR Pixel Class_RC= 4 AND NDVI_THR > 0

Table 6-4b: Dar-esalaam SPOT 1998, Rule base for the Reserved Areas

Table 6-4b, shows the rule base employed for the extraction of reserved areas from the 1998 SPOT image, whereas figure 6-12b is the corresponding decision tree. Both low and high NDVI values were associated with reserved areas whereas in general low texture values were used. The edge density image was not used in this case.

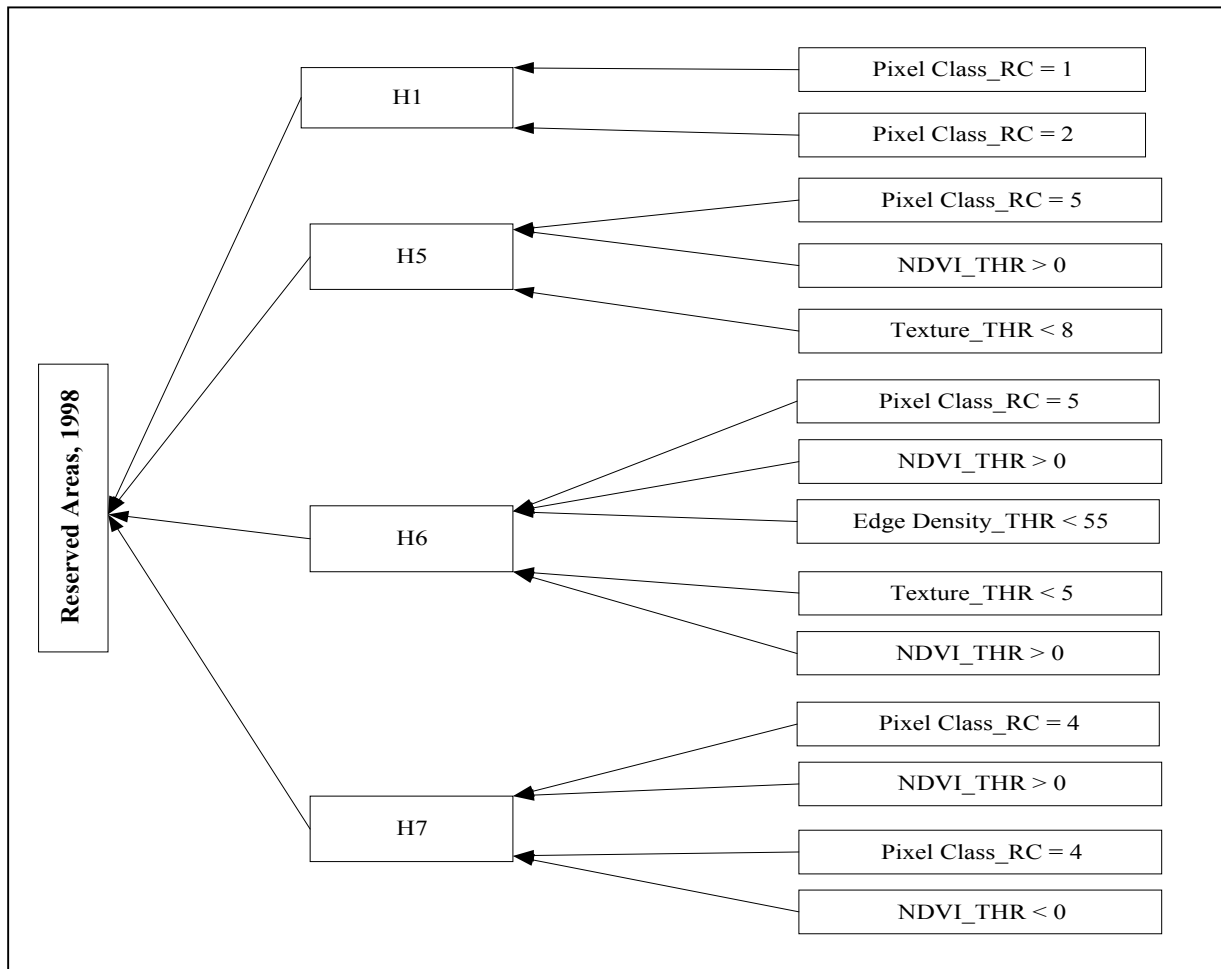

Fig. 6-12b: The Decision Tree for the 1998, Dar-esalaam Reserved Areas

The association of the rules follows the concept explained in Chapter 3, considering that two control strategies are supported namely, first rule first and the rule with the highest pre-set confidence value or certainty value are used to determine the hypotheses that is fired.

### 6.4.3 Knowledge-Based Interpretation

Once, the knowledge base has been established test modes can be executed and modifications appropriately effected. Ideally, this can be realized either by adding more knowledge in the knowledge base, varying confidence values or changing the structural order of the rules. Tests are then conducted until an acceptable solution is achieved. Two main concepts have been tested and presented here, namely (i) structural combinations and variations of confidence values and (ii) use of same values based on the two Hannover data sets.

(i) structural combinations and variations of confidence values

The following structural combinations and variations of confidence values illustrate this concept, based on the 1995 Landsat scene. Here are some rule translations with their corresponding outputs:

Case 1: All Confidence Values are the same.

```

IF      Texture = heterogeneous, and
        Cluster Class = built, and
        NDVI= Low, and
        Edge Density=High,
THEN the Hypothesis is Developed
ELSE, IF      Texture = homogeneous, and
        Cluster Class=non-built, and
        NDVI=High, and
        Edge Density=Low,
THEN the Hypothesis is Reserved.
    
```



Fig. 6-13a: Original Landsat TM1995

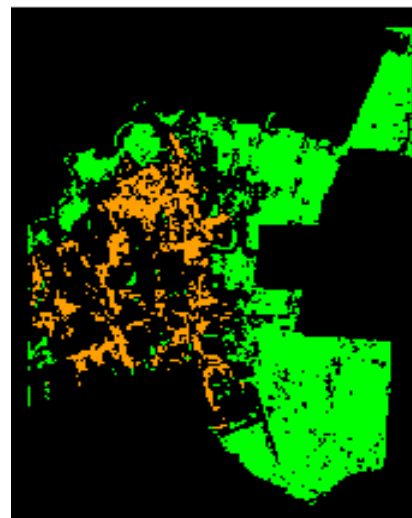

Reserved Areas, 1995  
 Developed Areas, 1995

Fig. 6-13b: Test Case 1

A visual comparison between the original Landsat, 1995 (figure 6-13a) image and the interpreted image figure 6-13b, shows that many pixels are unclassified (black) based on this structural set.

Case 2: Maintaining the same structural set up but varying weights or confidence values. This were assigned intuitively.

```

IF      Texture = heterogeneous(0.98), and
        Cluster Class = built(0.97), and
        NDVI= Low(0.95), and
        Edge Density=High(0.95),
THEN the Hypothesis is Developed
      ELSE, IF      Texture = homogeneous(0.97), and
                    Cluster Class=non-built(0.95), and
                    NDVI=High(0.97), and
                    Edge Density=Low(0.95),
      THEN the Hypothesis is Reserved.
    
```

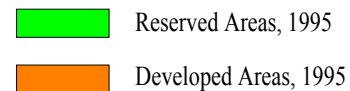

Fig. 6-14: Test Case 2

In this situation, the number of unclassified pixels have been minimized drastically, but the interpretation of developed and reserved areas is not quite acceptable as evident by visual comparison of the original Landsat 1995 image and the test case 2 (figure 6-14).

Case 3: Different Structural arrangement of the decision tree but maintaining the same weights as in case 1:

```

IF      Edge Density=High, and
        (IF      Texture = heterogeneous, and
          Cluster Class = built, and
          NDVI= Low),
THEN the Hypotheses is Developed
      ELSE, IF      Cluster Class=non-built, and
                    (IF      Texture = homogeneous, and
                      NDVI=High, and
                      Edge Density=Low),
      THEN the Hypothesis is Reserved.
    
```



Fig. 6-13a: Original Landsat TM1995

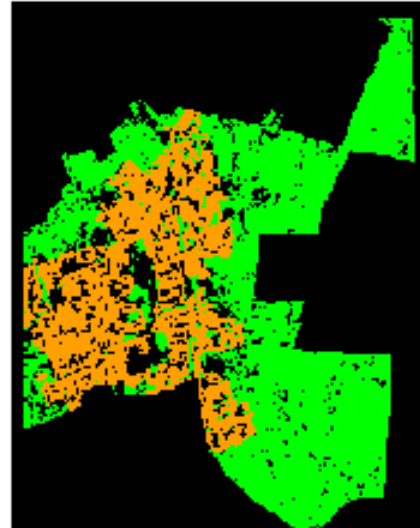

Reserved Areas, 1995  
 Developed Areas, 1995

Fig. 6-15: Test Case 3

Similarly, by comparing the test case 3 results and the original Landsat 1995 image reveals some unclassified pixels in addition to developed and reserved areas.

(ii) use of same values based on the two Hannover data sets.

The following examples show the effect of using the same parameters based on the two Hannover Landsat images, where the 2000 image was histogram matched to the 1995 image. The data sets used for cases 1, 2, and 3 is contained in table 6-1a, whereas for case 4 it is shown in tables 6-1b, 6-1c and figures 6-9(a , b).

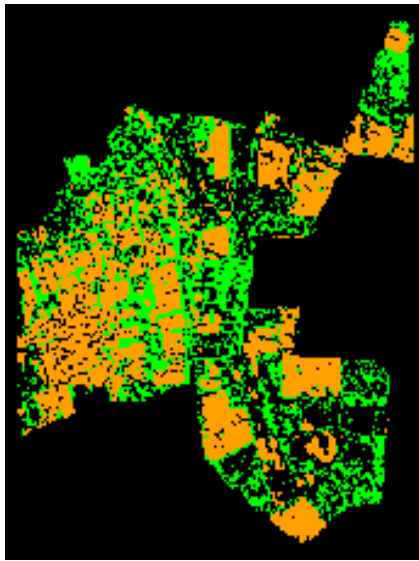

Fig. 6-16: Landsat 1995 image



Fig. 6-17: Landsat 2000 after histogram matching

Case 1: NDVI and Edge Density



Developed Areas
  Reserved Areas
  Unclassified

Fig. 6-16a: 1995 Landsat image case 1

Fig. 6-17a: 2000 Landsat image case 1

Comparing figures 6-16 and 6-16a, it is evident that some reserved areas have been classified as developed and there are many unclassified pixels which correspond to mainly reserved areas. On the other hand, for the 2000 Landsat image shown in figure 6-17a and comparing this with figure 6-17, shows that newly developed areas have largely been correctly identified and again conspicuously missing are the reserved areas as well as in part some previously developed areas. Similarly as in the case of the Landsat 1995, some reserved areas have been classified as developed.

Case 2: Edge Density and Texture

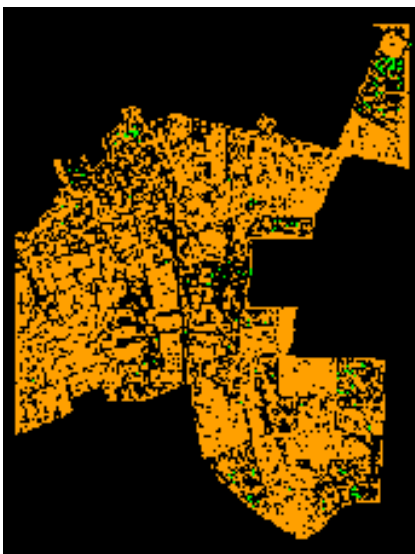

Developed Areas
  Reserved Areas
  Unclassified

Fig. 6-16b: 1995 Landsat image case 2

Fig. 6-17b: 2000 Landsat image case 2

In this scenario it can be concluded in general that edge density and texture images based on the values indicated in table 6-1a, tend to over classify developed areas in both cases as can be seen in figures 6-16b and 6-17b. Thus these two image primitives when used in combination are not useful for discriminating between developed and reserved areas.

Case 3: NDVI, Edge Density and Texture



Developed Areas
  Reserved Areas
  Unclassified

Fig. 6-16c: 1995 Landsat image case 3

Fig. 6-17c: 2000 Landsat image case 3

Combining the three primitives and based on the values in table 6-1a, shows that developed areas are to some extent detected in the 1995 image whereas reserved areas are barely detected. On the other hand, for the 2000 image new developed areas tend to be extracted at the expense of previously developed areas and to large extent the reserved areas.

Case 4: NDVI, Edge Density, Texture and Unsupervised Classification

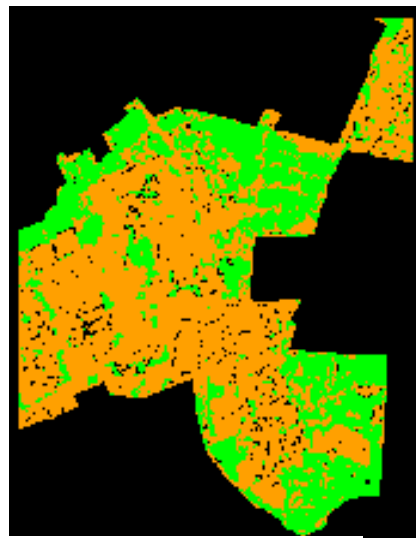
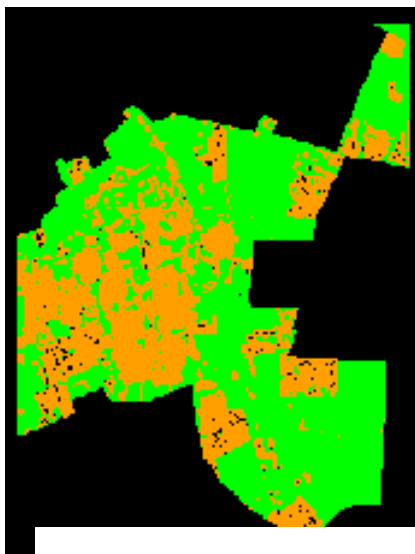

Developed Areas
  Reserved Areas
  Unclassified

Fig. 6-16d: 1995 Landsat image case 4

Fig. 6-17d: 2000 Landsat image case 4



A common set of parameters incorporating all the interpretation cues were used for this test case. In the 1995 Landsat image (fig. 6-16d), it is evident that some reserved areas were detected as developed areas and vice versa. On the other hand, for the 2000 Landsat image (fig. 6-17d) developed areas are to large extent discriminated from the reserved areas, nevertheless they tend to be over classified.

Consequently, due to the complexity in establishing a rule base that will work sufficiently for all cases, as has been shown by the examples above, it was deemed necessary to deal with each case independently. These are the domain specific rules discussed in section 6.3.2b whereas the following section gives the results obtained based on the these parameters.

### 6.4.4 Interpretation Results

The following are the interpretation results for the Hannover Landsat TM data sets and the Dar-esalaam SPOT image.



Fig. 6-18:1995, Landsat TM image

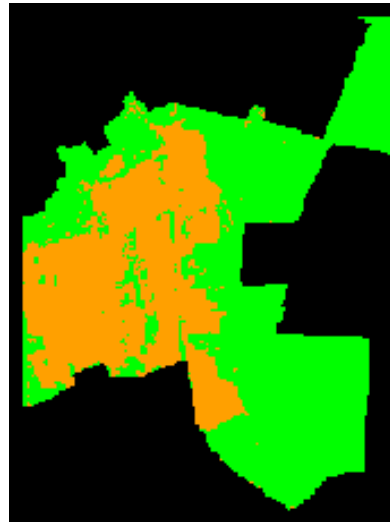

Reserved Areas, 1995  
 Developed Areas, 1995

Fig. 6-19:1995, Landsat TM Interpreted image

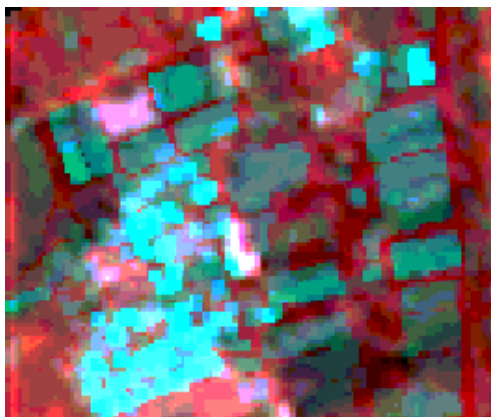

Fig. 6-18a:1995, Landsat TM zoomed image

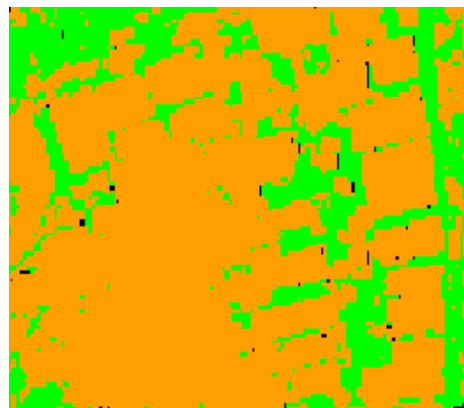

Fig. 6-19a:1995, Landsat TM Interpreted zoomed image

Figures 6-18 and 6-19 show the 1995 multispectral Landsat TM image and the corresponding interpreted image depicting the two classes namely developed and reserved areas respectively. Figures 6-18a is an enlargement of part of the image whereas figure 6-19a is the respective interpreted image.



Fig. 6-20: 2000, Landsat TM image

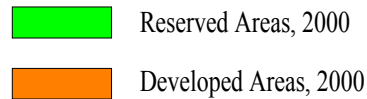
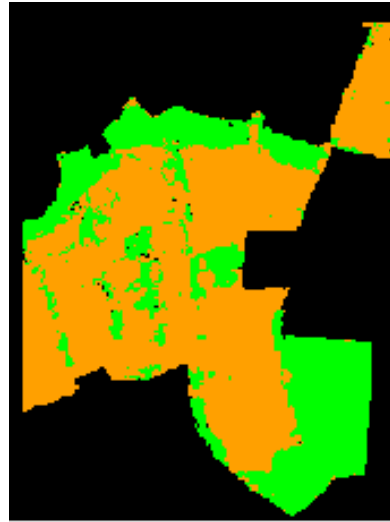

Fig. 6-21: 2000, Landsat TM Interpreted Image

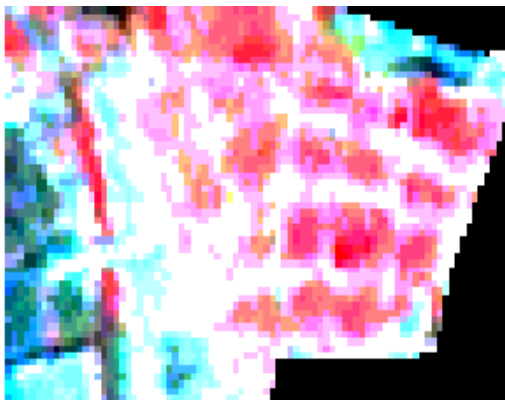

Fig. 6-20a: 2000, Landsat TM zoomed image

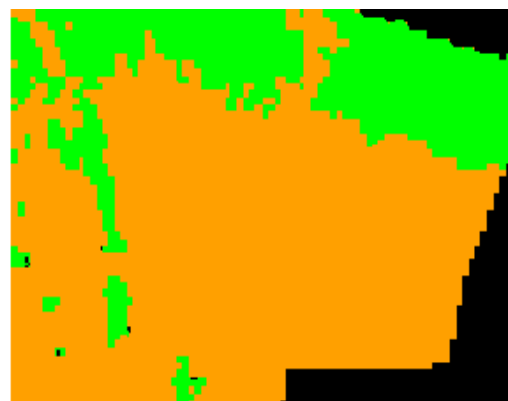

Fig. 6-21a: 2000, Landsat TM Interpreted zoomed image

Figures 6-20 and 6-21 show the multispectral 2000 Landsat TM image and the corresponding interpreted image showing the two classes namely developed and reserved areas. It is evident that in comparison to the 1995 Landsat image, new developments have occurred. On the other hand figures 6-20a and 6-21a are zoomed in images of a section of the original images showing how context can be used to depict the real ground situation. This is a parking area

characterized by both open and sealed regions, and according to the class definition, a parking area is categorized as developed, hence use of context information enabled this to be realized.

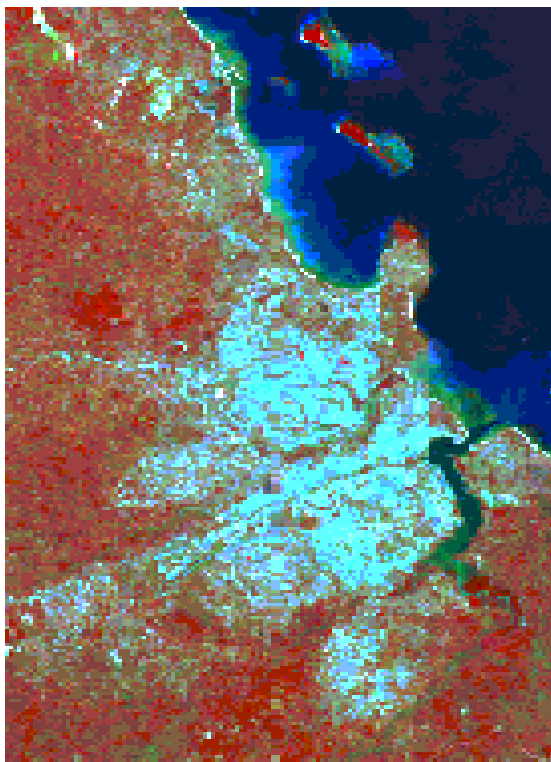

Fig. 6-22: 1998 Enhanced SPOT image

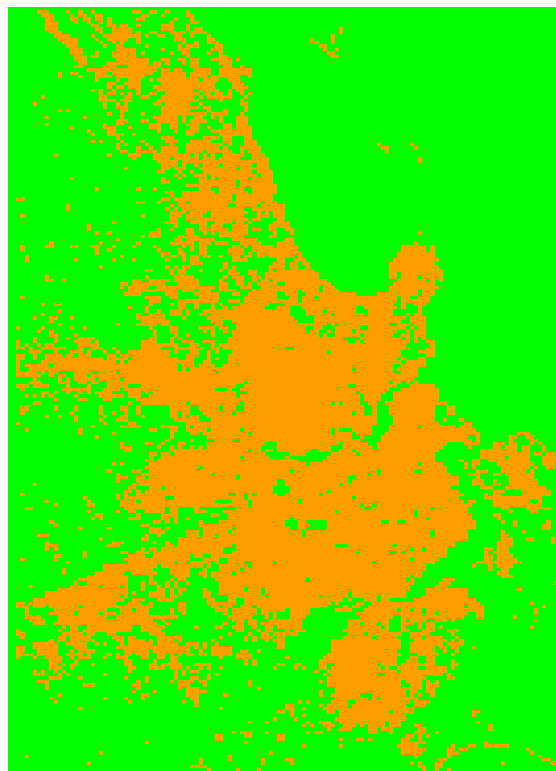

Fig. 6-23:1998, Interpreted Image

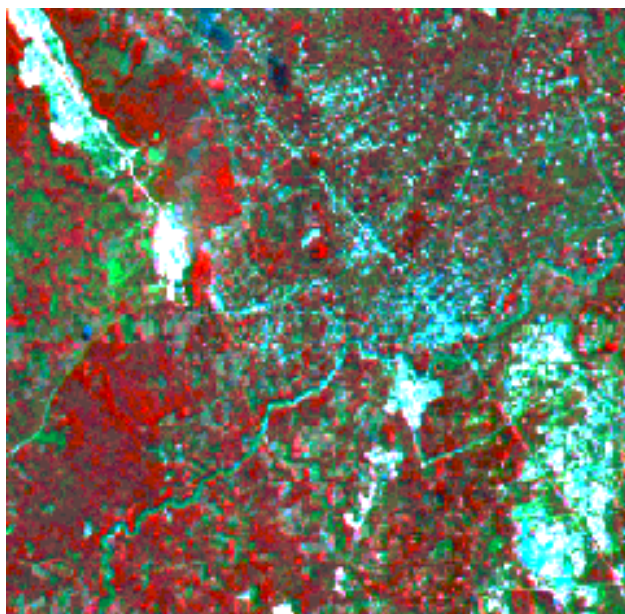

Fig. 6-22a:1998, SPOT zoomed in image

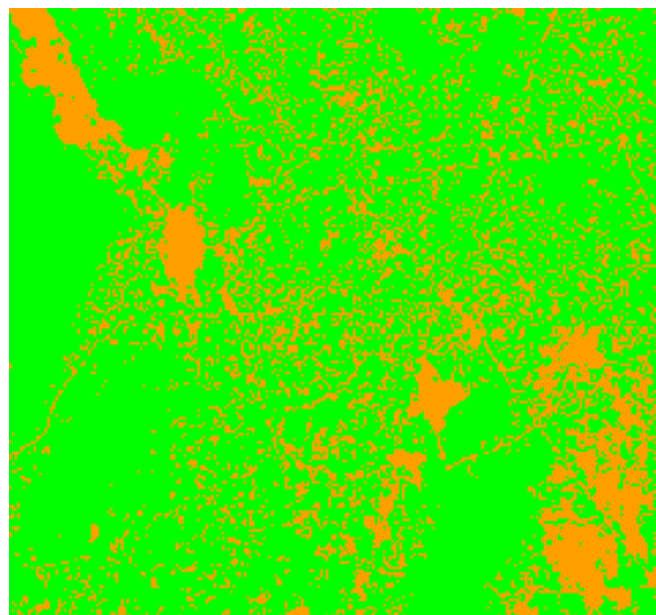

Fig. 6-23a: 1998 SPOT Interpreted zoomed image

The 1998 enhanced multispectral SPOT image of Dar-esalaam is shown in figure 6-22, whereas figure 6-23 is the interpreted image. A comparison of the enlarged images namely the multispectral figure 6-22a and the interpreted 6-23a show the level of detail of the features identified including linear features e.g. roads.

#### 6.4.5 Evaluation of the interpretation

Automated image interpretation is subject to errors of commission and omission and hence evaluation of the results is a fundamental requirement. For this reason reliable reference data is required and in most cases it is not readily available. Various techniques exist for evaluating the interpretation results, whereby in this study, the three indices tested included visual comparison, polygon-pixel count and the Kappa Index. Tables 6-5, 6-6 and 6-7 show the accuracies obtained based on these techniques.

For the interpreted 1995 Landsat TM for Hannover, a manually interpreted 1995 aerial image at 5m resolution was used for evaluation with the following results:

Evaluation Technique	Results
Visual Comparison	Highly Acceptable
Polygon-Pixel Count	90.0%
Kappa Index	0.82

Table 6-5: Accuracy evaluation for the 1995, Hannover Landsat image

This results show that the discrimination between the developed and reserved areas is satisfactory, and the three evaluation indices are a reflection of this conclusion.

The interpreted 2000 Landsat TM for Hannover was compared with the future land use map generated from the interpretation of 1998 aerial image at 5m resolution in combination with building plans, with the following outcome:

Evaluation Technique	Results
Visual Comparison	Highly Acceptable
Polygon-Pixel Count	89.0%
Kappa Index	0.86

Table 6-6: Accuracy evaluation for the 2000, Hannover Landsat image

The evaluation results indicate that the interpretation module is promising in extracting developed and reserved areas from remotely sensed data.

Finally for the interpreted, SPOT data, due to lack of ground truth data, the original SPOT XS image was used for the visual comparison and the kappa index evaluation, whereas 1992 land use map was used for the polygon-pixel count algorithm.

Evaluation Technique	Results
Visual Comparison	Highly Acceptable
Polygon-Pixel Count	98.0%
Kappa Index	0.80

Table 6-7: Accuracy evaluation for the 1998, Dar-esalaam SPOT image

Similarly the results obtained for the SPOT image are satisfactory as depicted in table 6-7.

In general, the first two evaluation techniques namely visual comparison and polygon-pixel count are more of qualitative in accuracy evaluation in comparison to the kappa Index which is quantitative in nature, this could explain the slightly low accuracy values in the three test cases.

## 6.5 Detection of unplanned developments

Additional information giving an indication of what is expected (**As It Should Be**) is necessary for the detection of unplanned developments. Within the planning context, a lot of indicators are taken into consideration in designing strategic plans. Such indicators include economical, social, environmental and institutional. However, due to complexity of real life situation, the inability to comprehensively model all the contributing factors is more often than not hampered and hence the mushrooming of unexpected phenomena. For visualization purposes, the spatial component plays a vital role in communicating such occurrences and this would be useful for planners in executing reaction planning.

### 6.5.1 Prognosis indicators

In this study, this concept has been developed, based on existing ground information at the time of planning in combination with planning data. This is then compared with the real situation, from where any differences are then said to be as a result of unplanned developments. The ideal EXPO area in Hannover, was used for demonstrating this concept. Specifically two scenarios were generated namely:

- Where the plan is adhered to
- And where it is not adhered to.

The first scenario involved, combining the existing ground situation in 1995 as depicted in the aerial photographs with the planning data generated, from the 1998 aerial photographs and building plans to yield three classes, namely reserved, already developed and legal transition areas for development. This is an ideal situation as depicted in the EXPO area, i.e. one to one correspondence between the plans and the existing ground situation.

The prognosis information with the three classes i.e. reserved, developed and legal transition is perturbed to replicate the second scenario whereby some areas not meant for legal transition are in reality developed. This is achieved by recoding a class essentially meant for legal transition as reserved.

For detection purposes these two scenarios are compared with the real ground situation as depicted by the 2000 interpreted Landsat image.

### 6.5.2 Results of the Detection of Unplanned Developments

For the detection of unplanned developments two scenarios have been presented, an ideal situation (1) where the plans are adhered to and a simulated real situation (2), which based on the prognosis information enables the detection of unplanned developments.

Scenario 1 (Ideal Situation)

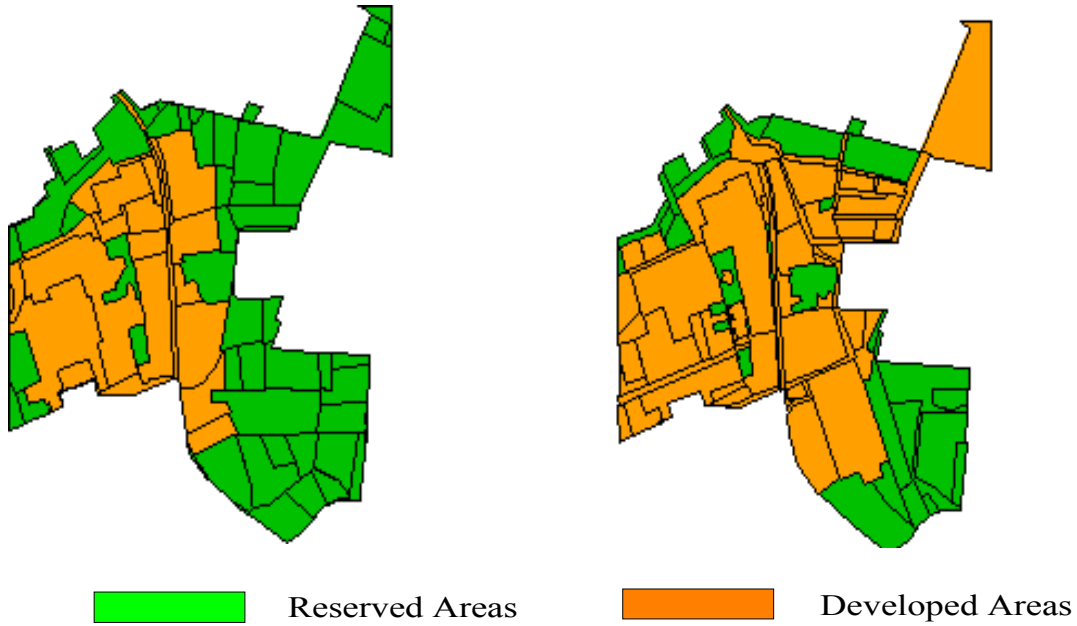

Fig. 6-24a: 1995 Manually Interpreted Image

Fig. 6-25a: Planning Data

Figure 6-24a shows the **As it Were** situation, whereas figure 6-25a is the extracted planning information showing in general developed and reserved areas. When the two are combined, then the prognosis information is obtained showing new areas of development i.e. **As it Should Be**, as shown in figure 6-26a. Thus three classes are depicted namely, areas that are developed and reserved in both epochs and a third class depicting those areas that should be converted from reserved to developed, i.e. legal developments.

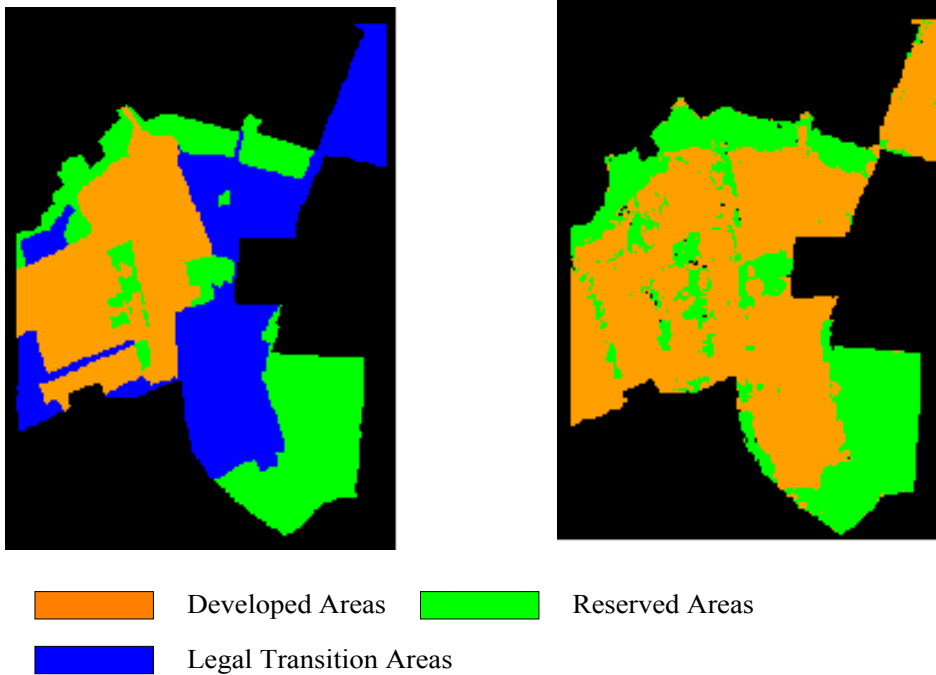

Fig. 6-26a: Prognosis Information

Fig. 6-27a: Landsat 2000 interpreted image

A comparison of the **As it Should Be** situation with the **As It IS** as interpreted from the 2000 Landsat image figure 6-27a, shows that the two images are fairly in agreement. In principle, the implication here is that the plan has been adhered to.

Scenario 2 (Real Situation)

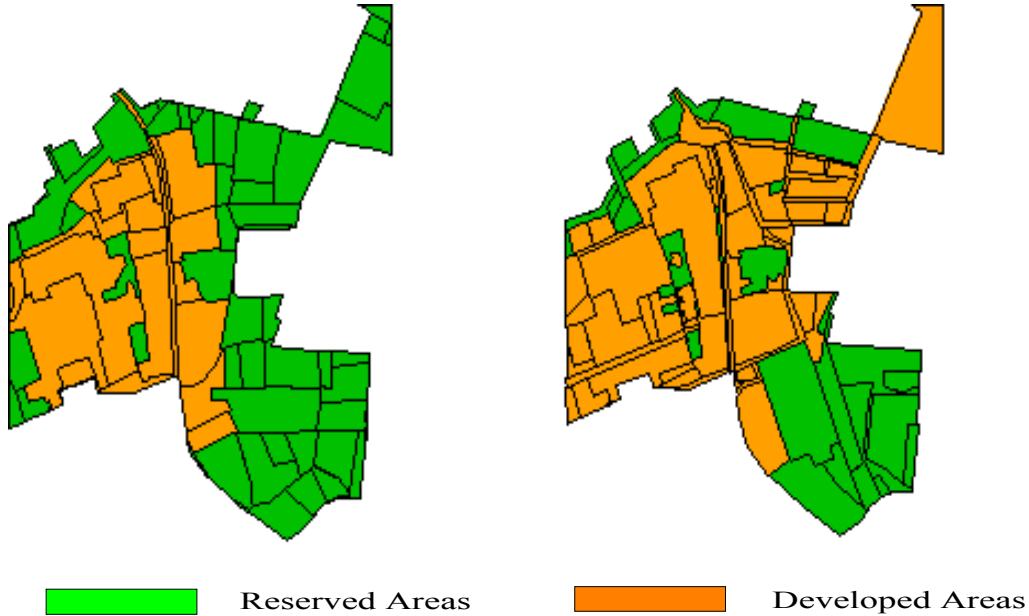

Fig. 6-24b: 1995 Manually Interpreted Image

Fig. 6-25b: Planning Data

In this scenario, some perturbation have been introduced in the planning data, whereby an area which is ideally meant to be developed is now for the purpose of the detection of unplanned developments assigned not to be developed. Using the same set as for the ideal situation, figure 6-24ba shows the **As it Were** situation, whereas figure 6-25b is now the simulated planning information showing in general areas to be developed and those not to i.e. reserved areas. Combining the two sets of information, leads to the simulated prognosis data depicting new areas of development i.e. **As it Should Be**, as shown in figure 6-26b. Similarly, three classes are shown namely areas that are developed and reserved in both epochs and a third class that should be legally converted from reserved to developed, i.e. legal developments.

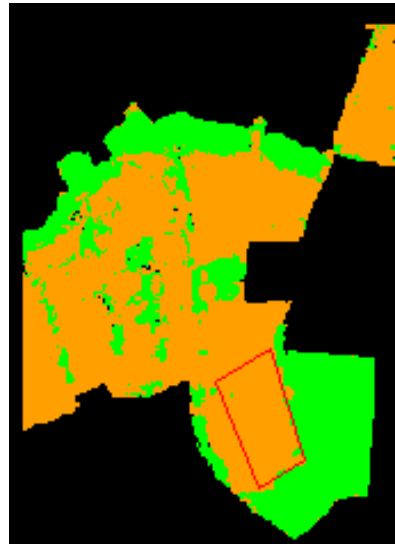

Fig. 6-26b: Prognosis Information

Fig. 6-27b: Landsat 2000 interpreted image

It is evident that there are some disagreement, between what should be expected on the ground and what is really on the ground according to the prognosis **As it Should Be** (fig. 6-26b) and the **As It IS** situation (fig. 6-27b). This means therefore that unplanned developments have been detected, and based on such a scheme, planners could have a starting point in deciding on what measures to undertake.

**6.5.3 Evaluation of the Detection of Unplanned developments**

In an ideal situation, it would be useful to do a rigorous ground truthing which may entail field checks especially where in developing countries the possibilities of obtaining high resolution aerial photographs is an expensive undertaking. Nevertheless, for the purpose of this study, the existing manually interpreted aerial photographs have been employed to give a quantitative assessment of the results. Hence, based on the planning information the following evaluation has been arrived at:

Evaluation Technique	Results
Visual Comparison	Highly Acceptable
Polygon-Pixel Count	89.0%
Kappa Index	0.86

Table 6-8a: Accuracy evaluation for the Detection of Unplanned Developments (Ideal Situation)

The detection of unplanned development results show some promising results according to both the qualitative and quantitative accuracy assessments.



Evaluation Technique	Results
Visual Comparison	Highly Acceptable
Polygon-Pixel Count	88.0%
Kappa Index	0.83

Table 6-8b: Accuracy evaluation for the Detection of Unplanned Developments (Real Situation)

Similarly in this situation where the actual detection of unplanned developments is realized imply that the concept is practical and can be employed in areas confronted by the challenge of unplanned developments e.g. in the developing countries.

## 6.6 Monitoring Trend of Unplanned Developments

The ability of remotely sensed data to continuously provide a synoptic view of the actual situation on the ground is one of the benefits being exploited for dynamic studies e.g. urban growth, deforestation, agriculture, disaster monitoring, etc. Within the framework of urban environments undergoing rapid changes in terms of growth, the location and extent of the new developments are vital indicators for subsequent reaction planning, particularly if the new developments are extensions of unplanned developments.

### 6.6.1 Trend Modeling

In general, modeling aims at generating alternative scenarios based on some reasonable rationale. In areas prone to rapid growth characterized by unplanned developments, planners would be interested in studying their tendencies. This entails establishing which of the new developed areas are an extension of unplanned developments. The assumptions based on the data available and their relevance to trend modeling include:

- Compatibility of land uses, which implies that existing land uses do influence new land uses, in this case further growth will tend to weave out based on its origin of growth.
- Ease of communication, i.e. nearness to main transport routes.
- Nearness to hydrographical features, i.e. proximity to existing sources rivers.

Thus, the following procedure was adopted:

- The newly developed areas are extracted by masking previous developed areas in 1992 using the 1992 land use data and the 1998 interpreted image.

Once the new developed areas have been detected, the next step involves assessing the relationship between these areas and the proximity to the existing unplanned developments, main transport system and hydrology. This involved:

- Creating buffers with varying distances from 20 to 200 and combining them with the new developed areas separately.
- Secondly, a combined effect is evaluated whereby the proximity to the rivers is made as large as possible due to risk of flooding, road proximity is also assumed reasonably due to the non-uniform distribution of the transport network and the two are kept constant (i.e. 300m and 80m were assumed respectively) and what is varied is the

information pertaining to the nearness to the already existing unplanned developments (i.e. 60m, 80m and 100m were tested).

Figure 6-28 shows the rule base used for the trend prediction. The unplanned developments were included for completeness and to enable visualization of the prediction results in relation to the already existing unplanned developments.

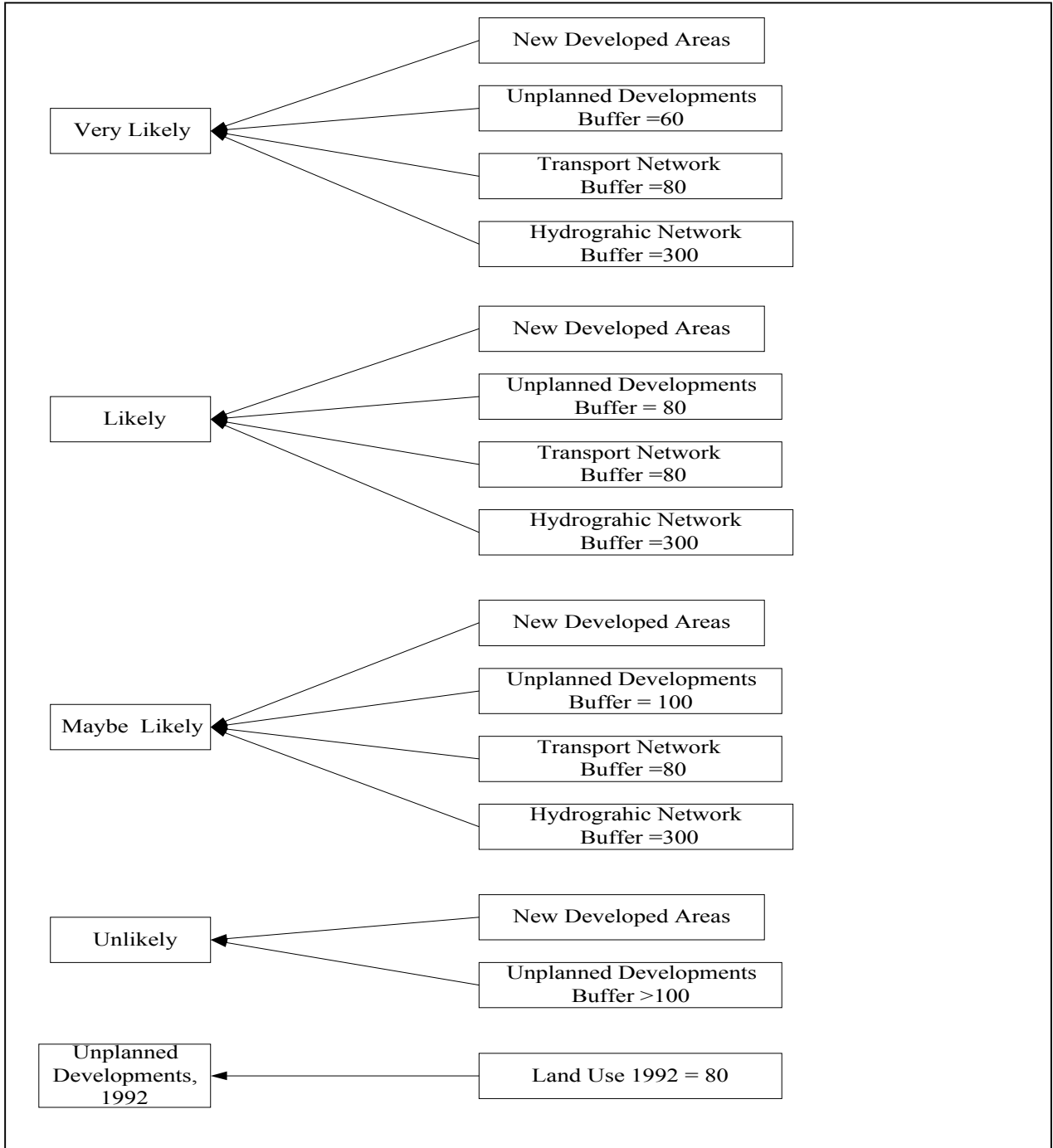

Fig. 6-28: Trend Prediction Rule base

### 6.6.2 Results of Trend Monitoring

Figure 6-29 shows three aggregated classes namely reserved, planned and unplanned developments as of 1992. The developed areas in 1992 are masked based on the 1998 interpreted image figure 6-30 to yield newly developed areas as shown in figure 6-31

a) Masked New Developed areas based on 1992 land use image and 1998 interpreted image

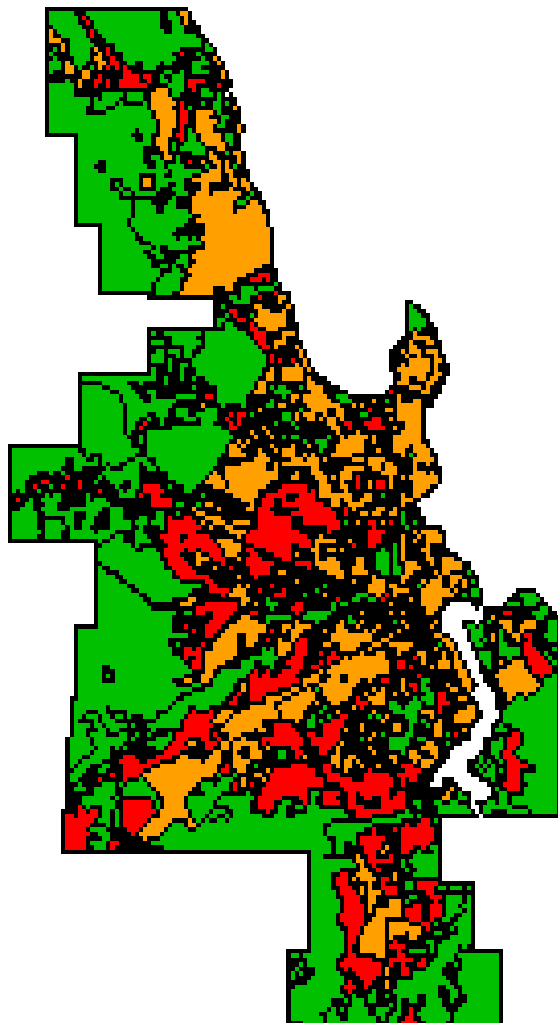

Fig.6-29: 1992, Land Use Map

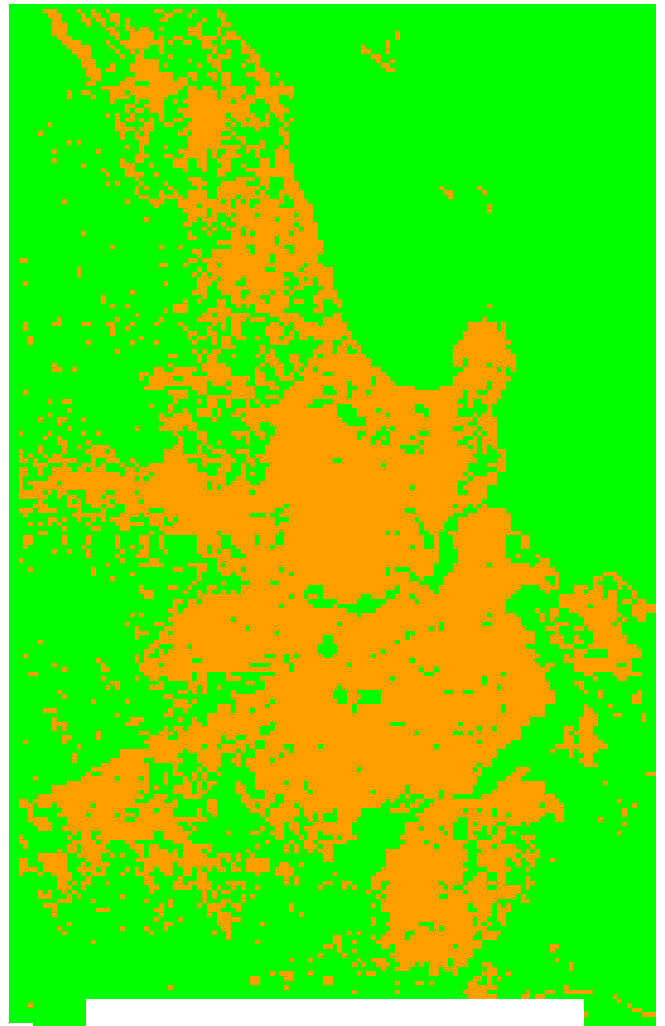

Fig. 6-30:1998, Interpreted Image



 Newly Developed Areas, 1998

Fig.6-31:1998, newly developed areas

b) Influence of existing physical features on new developed areas whereby in this study hydrographic, transport network, and existing unplanned developments were tested. The following results show the modeled outputs based on the new developed areas and the land use drivers.

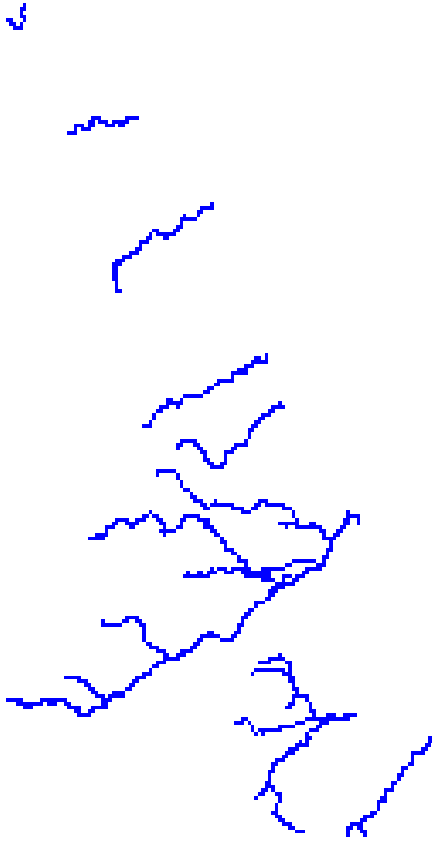

Fig. 6-32: River Coverage

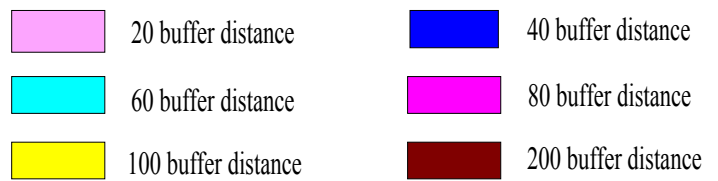
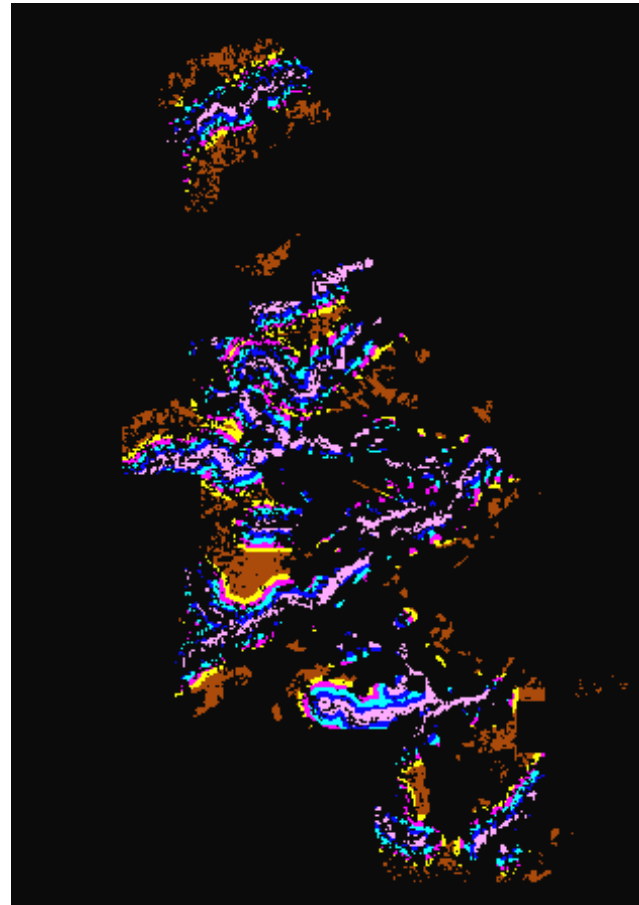

Fig. 6-33: River buffer

i) The influence of rivers on the new developed areas based on different buffer distances namely 20, 40, 60, 80, 100, and 200 is being illustrated by these figures. Specifically, figure 6- 32 shows the distribution network of the rivers within this study area, which were used as inputs for the buffering. On the other hand, figure 6-33 shows the new developed areas falling within each buffer region.

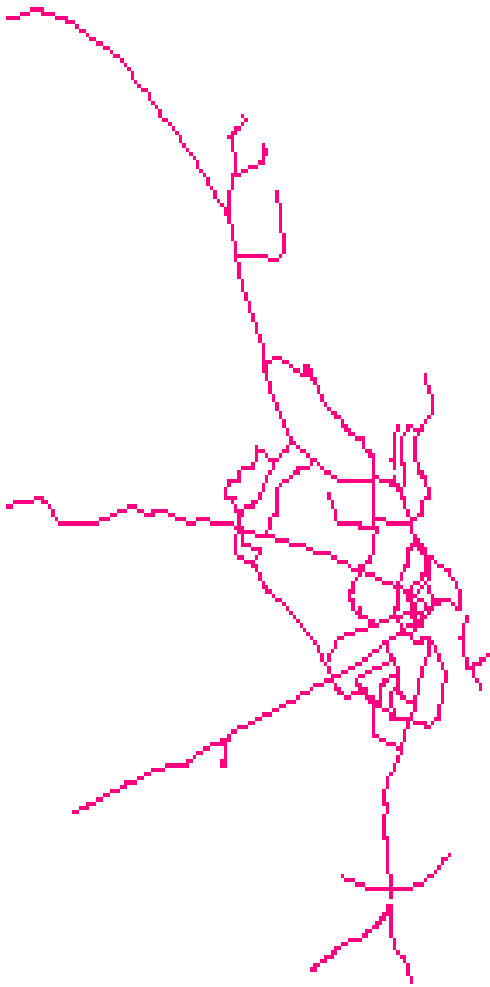

Fig. 6-34: Road Coverage

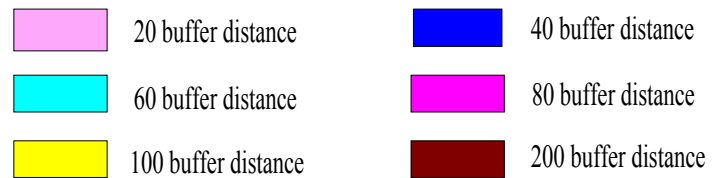
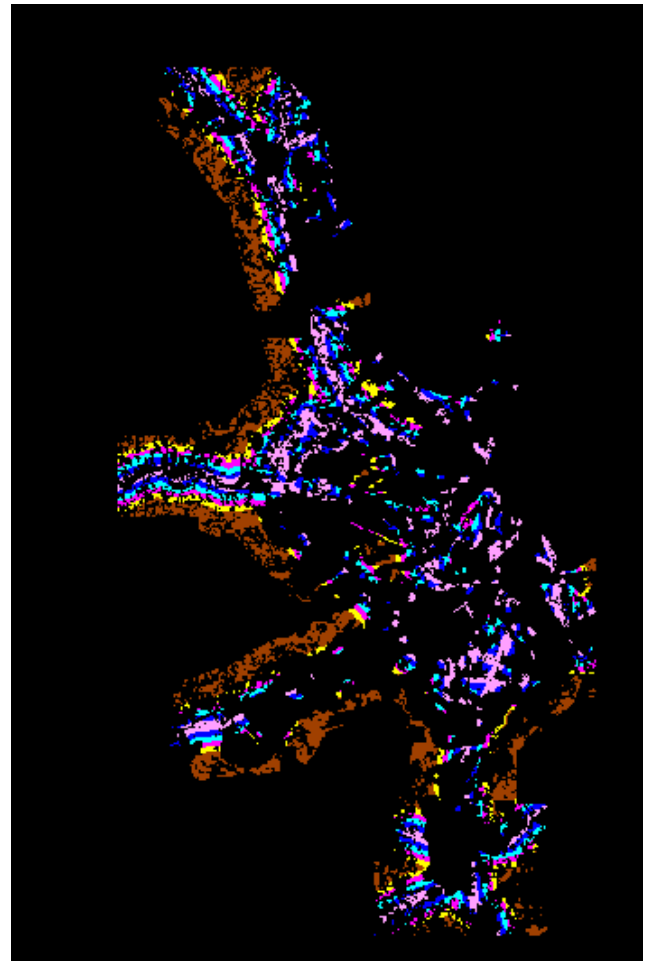

Fig. 6-35: Road buffer

ii) The transport network also does have some influence on the growth of an urban area. Figure 6-34 shows the main transport network within this study area. Buffers were generated i.e. based on 20, 40, 60, 80, 100, and 200 distances and were used to establish how much of the new developed areas occurred within each buffer distance and the results are shown in figure 6-35.

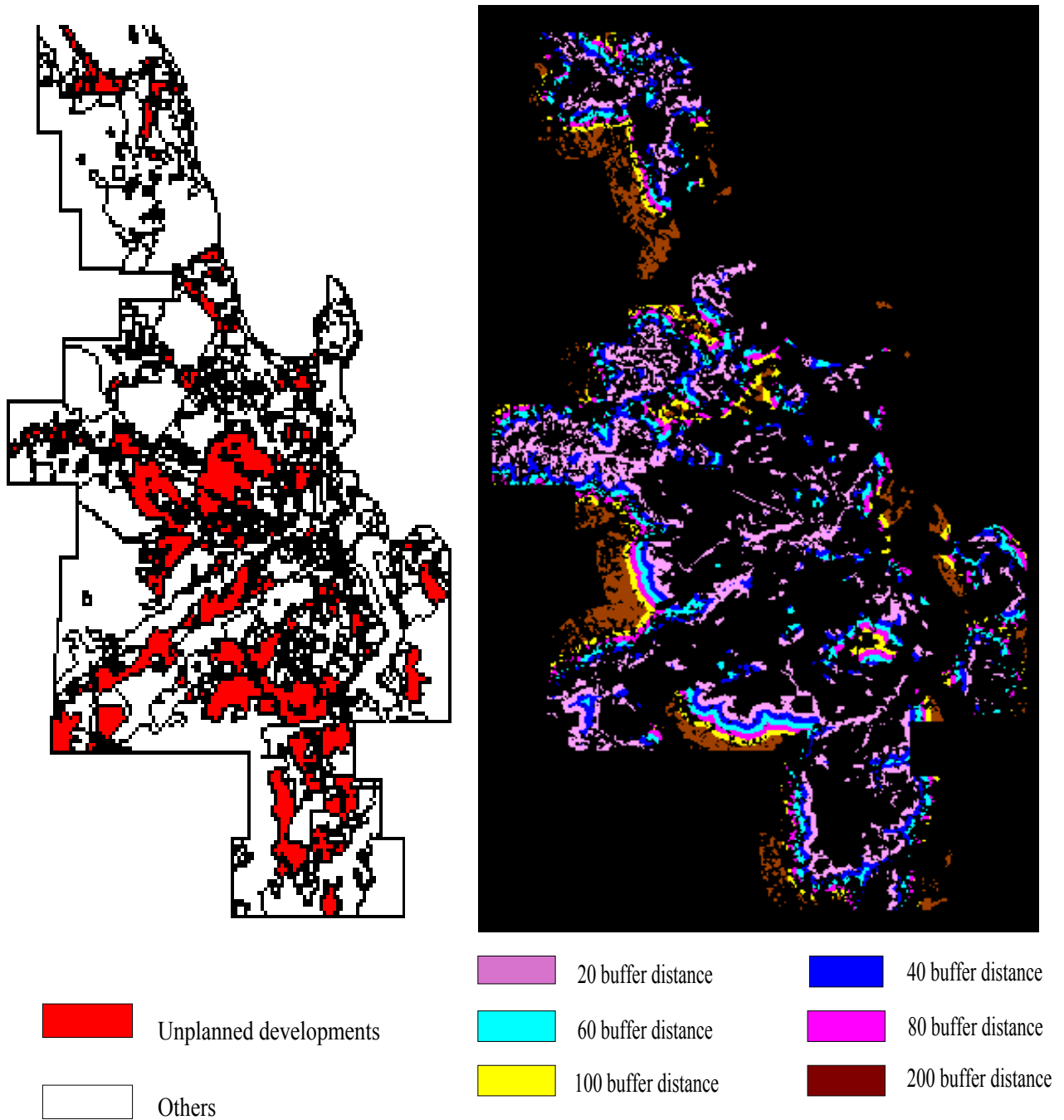

Fig. 6-36: Informal developments coverage Fig. 6-37: Informal developments buffer

iii) The ultimate goal is to establish which of the new developed areas are likely to be an extension of the unplanned developments. Therefore, existing unplanned developments figure 6-36 are also used as variables in the prediction model. Neighborhood characteristics are also generated based on 20, 40, 60, 80, 100, and 200 buffer distances which are then used to extract new developed areas within each of the buffer distances. This output is depicted in figure 6-37.

iv) Figure 6-38 shows the statistical summary of the new developed areas based on the three variables tested. The y-axis shows the % of new developed areas whereas the x-axis are the neighborhood extent. For each neighborhood of each variable, the percentage of new developed areas is computed and represented as shown.

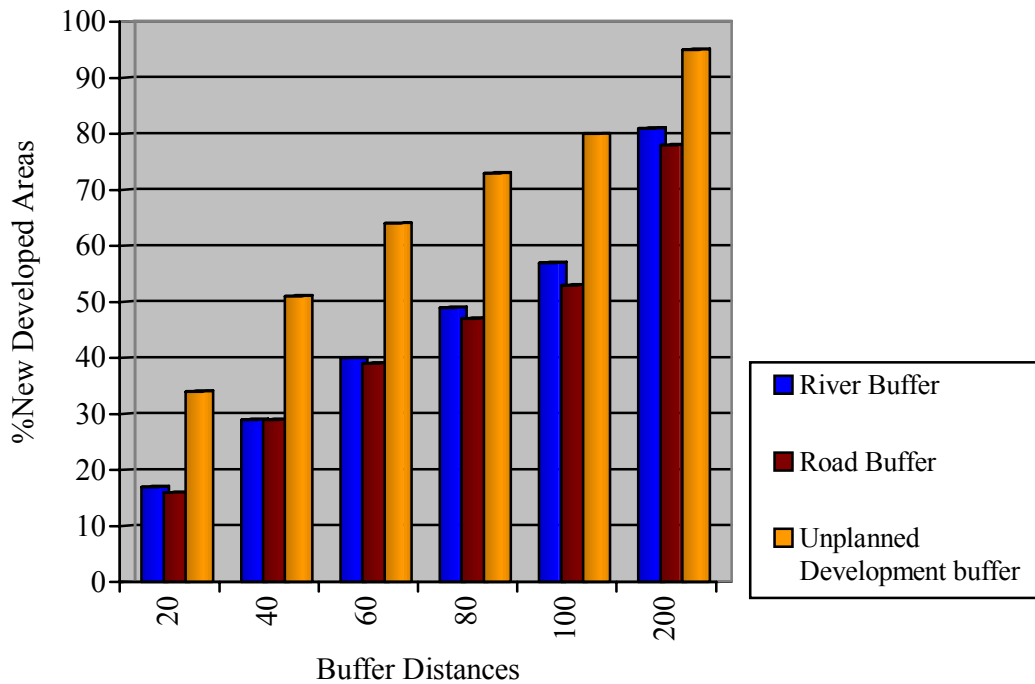

Fig.6-38: Comparison of new developed areas based on river, road and unplanned developments

- a) Figure 6-39 shows the predicted results on the basis of the assumptions adopted in this study. The prototype of the weighted new developed areas on the basis of neighborhood to the already existing unplanned developments (60m, 80m, and 100m), communication network (80m), and hydrography (300m). The classification of the likelihood of new developments being unplanned are also shown, starting with very likely to those that are unlikely in accordance with the rational defined in section 6.5.1.

The existing unplanned developments mapped in 1992 have been included in the modeling results for better visualization and comparisons. In general, it is evident that what has been modeled as very likely extension of unplanned developments is in close proximity to the 1992 unplanned developments. This is what one would expect, since new developments tend to take place in areas that are compatible with the already existing ones.



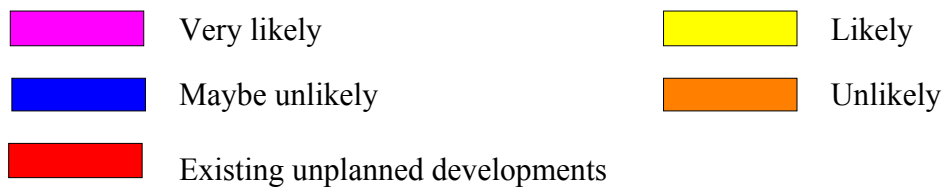
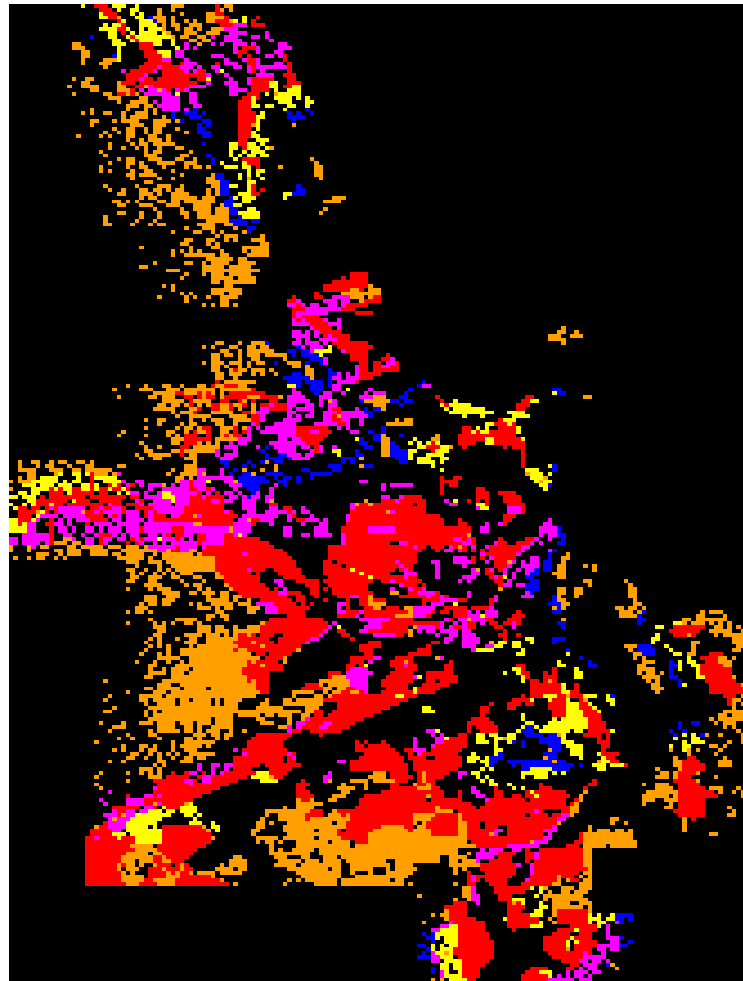

Fig. 6-39: Modeled scenarios of possible extensions of unplanned developments

### 6.6.3 Evaluation of the Trend Monitoring

The prediction of the extent of growth of unplanned developments is subject to confirmation. Normally field survey or current aerial photographs could be used to check against the modeled results thereby enabling appropriate action to be executed. This is especially important since the extension of unplanned developments is based on existing urban physical configuration which may not be exhaustive or a comprehensive enough in representing the real situation, i.e. there are other factors which could influence this expansion. Nevertheless, the model so developed is such that it can easily be expanded to accommodate more knowledge or drivers as they are acquired.

For this case study, ground truth data (fig. 6-40) was provided by the Ministry of Lands and Settlement, Sustainable Dar-esalaam Project (SDP) through the courtesy of UCLAS, University of Dar-esalaam. Due to lack of controls for co-registration purposes that would

have facilitated evaluation through polygon-pixel count and kappa index, only visual comparison was conducted with the modeled results (figure 6-39) to establish relatively to what extent the pixels classified as very likely and likely are extensions of unplanned developments on the scale of highly acceptable, acceptable and unacceptable.

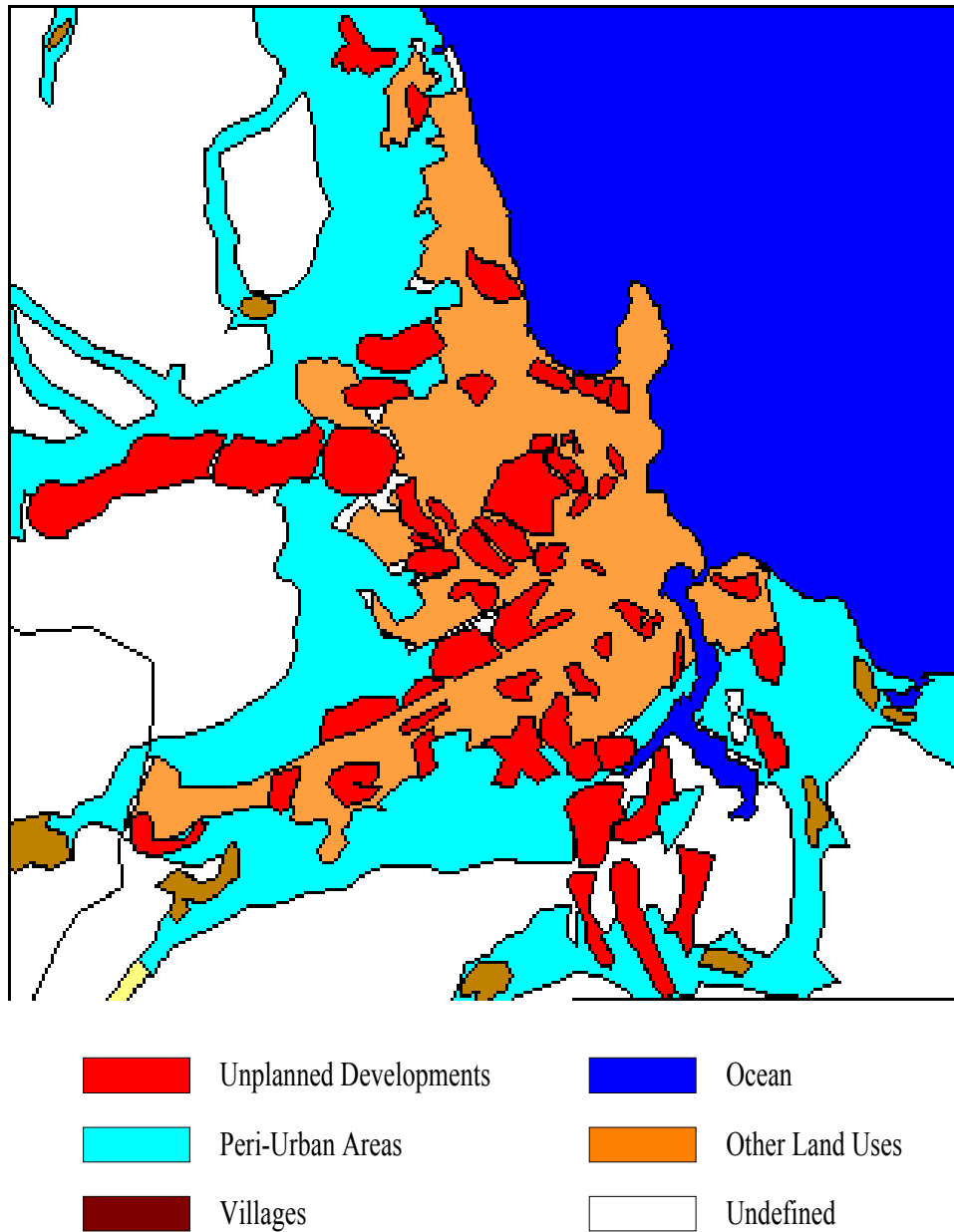

Fig. 6-40 : Major Unplanned Developments, 1999 (Source 1992 Aerial photographs, Field survey, 1999)

Qualitative evaluation based on the visual comparison technique, of the modeled extension of unplanned developments and 1999, ground truth information show comparable results, which could be rated as acceptable.

## 6.7 Discussion of the Results

The fundamental concept that has been developed in this study has two main aspects namely the detection of unplanned developments and monitoring their trend, whereby the focus in this chapter has been the testing and evaluation of the methodology. In this regard, two study sites were used for the prototypes, namely the Hannover data sets for the detection of unplanned developments whereas the Dar-esalaam data was employed for the monitoring their trends.

For the interpretation of the remotely sensed data it is evident that, a thorough knowledge of the data and the expected outputs is very vital in extracting appropriate variables and establishing the rules. The possibility to quickly execute tests based on different structural combinations and image cues is an added asset in the selection of a suitable rule base. Experience has shown that, although the global knowledge applies to basically most remotely sensed data in as far as the extraction of developed and reserved areas are concerned (see section 6.3.2 (a), more specific domain knowledge is required for each scene used in this study as shown in section 6.3.2 (b). This is also valid when dealing with the same area, in particular where so much changes have taken place (e.g. in the case of the two Hannover data sets) accompanied by seasonal variations. Even after histogram matching the two images, the use of similar values for the two images were unsatisfactory as shown in section 6.3.3. Thus image interpretation becomes more domain specific as shown in the specific rule bases for the three scenes in section 6.3.2 (b).

In general, although human beings have impressive capabilities for abstractions, analysing and interpreting remote sensing data, automating such a process is not a trivial task. Studies have also shown that, the quantity of features used is not what determines the best results, this implies that the more features used does not necessarily lead to better outputs [You and Jain, 1984]. Coupled with this problem, is one of determining which rules to associate with each other in addition to dealing with rule correlation. One way of going round the problem is data refinement prior to incorporating it in the rule base, i.e. data reduction. This will ensure that rule correlation is avoided to some extent. This has largely been exploited in this study in the labelling of the features level. The expert system used in this study supports only two control strategies namely first rule first and the rule with highest confidence value, therefore this was a consideration in the hierarchical configuration of the rules.

The evaluation of the interpretation results based on the three techniques namely visual, polygon-pixel count and kappa index show comparable and acceptable results. Nevertheless, limited knowledge employed in this study does explain the misclassification or ambiguities in the results. This problem could be circumvented by incorporating more knowledge e.g. from GIS data into the interpretation process.

The concept developed for the detection of unplanned developments shows that it is possible to automate the process by exploiting planning data and frequently acquired remotely sensed data for urban areas. It has been demonstrated that GIS can easily be used in the combination of the **As It Were** status at the time of planning and the planning data where in this case building plans to yield the **As It Should Be** status. In order to establish whether unplanned developments have occurred it has been demonstrated that a simple comparison between the expected status and the existing ground situation **As It Is** derived from remotely sensed data can be employed.

The evaluation of this concept on the detection of unplanned developments based on the three techniques namely visual comparison, polygon-pixel count, and kappa index show comparable results which implies that such a scheme is feasible.

Once detected, trend monitoring is important as a response action to ensure timely sustainable solutions. The results obtained from the trend modeling system show that the existing unplanned developments tend to have more influence on newly developed areas in comparison to the other weighting parameters namely proximity to main communication network, and hydrography as seen from figure 6-38. This could be an indicator of the extension of unplanned developments. As a rule of thumb, new developments tend to occur in areas compatible with existing land uses. The initial low influence by the existing hydrographical sources can be attributed to the fact that the terrain is relatively flat and there are risks of flooding in the event of heavy rains and therefore few developments are likely to take place very close to the rivers, on the other hand ease of communication parameter indicates the need to extend and fairly distribute the network in order to cater for the diverse land uses particularly residential areas. An attempt to prioritize new developed areas based on these weighted indicators on a fuzzy scale, namely very likely, likely, maybe likely, and unlikely could assist planners in strategizing their reaction planning processes in the situations whereby there is dynamic growth characterized by unplanned developments.

However, before embarking on reaction planning, such modeling results should also be evaluated to ensure that this is a reflection of the existing ground situation. In this study only visual comparisons could be made due to the nature of ground truth information as discussed in section 6.5.3. with promising results. It is important to note that an objective judgment based on visual comparison can only be realized if one is conversant with the area and subject under investigation.

*The methodology developed has been tested based on the available data sets. The detection and monitoring of unplanned developments has been shown to be feasible. The various stages involved including the inputs and the specific processes have been demonstrated. Thus such a prototype could be extended to address real life situations where such phenomena are prevalent.*

## CHAPTER 7

### SUMMARY, CONCLUSIONS AND RECOMMENDATIONS

#### 7.1 SUMMARY

The proliferation of unplanned developments and the need to detect and predict their trends has been the motivation of this study. In general, resource constraints and lack of suitable sustainable techniques have been cited as the drawbacks in addressing this problem efficiently. Thus, the focus of this study has been on the development of a methodology for the detection and trend prediction of the unplanned developments. The emphasis has been on the application of remotely sensed data in combination with planning data for the detection purposes on one hand, and on the other, the use of urban growth drivers based on existing ancillary information (hydrography, transport system, and existing unplanned developments) to establish 'hot spots', likely to be converted into unplanned developments. This information is then combined with new developed areas obtained from remotely sensed data to establish which of the highlighted zones 'hot spots' have been converted. This study has been divided into four modules, whereby the first module has dealt with the extraction of developed and reserved areas from multispectral satellite image, the second module has focussed on the detection of the unplanned developments, their trend prediction has been handled in the third module and finally the possibilities of evaluating such results have been elucidated in the fourth module.

In general, remotely sensed data is used as the source for depicting areas that are developed and reserved. A rule based system has been used for the extraction of this information, where the fundamental concept detailing the various components has been elucidated in chapter 3. The interpretation cues exploited include texture, edge, NDVI, clustered information. Experience has shown that the success of object extraction within a rule based system is based on how well they can be characterized from the features and their subsequent representation. Characterization can either be unique or partial, where the former implies that the object can be defined with no ambiguities whereas the latter, the object has some level of uncertainty. The identification of these two scenarios a priori is vital as it determines the hierarchical configuration of the decision tree. The importance of some features in the extraction and discrimination of developed and reserved areas based on the data sets used in this study is detailed in section (6.7). Further, although the global rules can universally be applied to the objects being addressed, each scene has to be treated specifically. Thus, the complete transferability of a knowledge base for image interpretation use with another image scene is not entirely feasible and requires some modifications to suit the scene under investigation i.e. it is predominantly domain specific. Such conclusion have also been arrived at by Meinel et al. [2001].

The purpose of extracting developed and reserved areas is to use this information as an input in combination with ancillary information for the detection and trend prediction of the unplanned developments. The methodology adopted has been the subject of chapter 4. In particular, how planning information can be exploited for purposes of the detection of this phenomena. Ideally, land use plans have been used as a development hard constraint. Although, in reality they should be used to calibrate variables reflecting historical influences of land use plan designations on patterns of development. Furthermore, the limitations of the master plan, is that it portrays a city as a system of transport networks and distributed physical entities, with little regard to the human aspect. However this study has shown that since plans in most cases highlight new areas of development, they could be employed in combination

with remotely sensed data showing **As It Were** status to depict new areas of legal developments, i.e. **As It Should Be** status with respect to the existing ground situation at the time of planning. This then forms a backdrop for the detection of unplanned developments, which are essentially the discrepancies between the **As It Should Be** status and **As It Is** within the planning and implementation time frame. Thus limitations or constraints are not always the bottleneck but could be turned around to some advantage as shown in this study. Prototype experiments carried out show that this is a feasible technique and can easily be implemented. Hence planners in the developing countries confronted with this challenge of mushrooming unplanned developments can easily use this up to date information to execute reaction planning.

On the other hand, once detected, it would be in the interest of the planners to be in a position to identify 'hot spots' namely areas likely to undergo extension of unplanned developments so that in case of such an eventuality, they will be able to react in a timely manner. This study, has based the prediction process on the existing urban physical features configuration, specifically detected unplanned developments, transport system, and hydrographical features. However, it is possible to expand this system to incorporate more planning drivers in the modelling. The zoning of these 'hot spots' can further be categorized on a fuzzy scale namely very likely to those that are unlikely extensions of unplanned developments. Developments taking place in this zones can then be monitored using remotely sensed data.

Three possible mechanisms for the evaluation of the extracted and modelled results have been proposed namely visualization comparisons, polygon-pixel count and the kappa index (chapter 5). The basic requirements and the evaluation processes have been elucidated.

Prototype experiments (chapter 6) to test the modules based on the two data sets namely from Hannover and Dar-esalaam, show that this concept is feasible and easily transferable. Moreover, these processes which have otherwise been manual, can be automated thus reducing the turn around time planners have to wait for information in order to make informed decisions, where in this case pertains to reaction planning.

## 7.2 CONCLUSIONS AND RECOMMENDATIONS

The fundamental objective of this study was to develop a methodology that exploits existing planning data and urban architectural configuration in combination with remotely sensed imagery for the detection and quantification of unplanned developments and subsequently facilitate in monitoring their trends. The role of the remotely sensed data is to provide information pertaining to the extent of developed and reserved areas at any given epoch, as required. Consequently, the specific objectives addressed include:

- How well remotely sensed data can be used to discriminate between developed and reserved areas within an automatic knowledge based system (Image Interpretation Module);
- How prognosis information within a given time frame can be generated based on planning data and remotely sensed data thus giving the situation **As It Should Be**, and used in combination with current remotely sensed data showing the **As It Is** status for the detection of unplanned developments (Detection Module);

- How existing urban physical features can be employed as pointers or drivers for monitoring subsequent expansion of unplanned developments, i.e. (Trend Prediction Module).
- Possibilities of evaluating results emanating from such processes (Evaluation Module).

The automation of the extraction of developed and reserved areas from remotely sensed data within a knowledge based system is quite promising. The possibility of incorporating many interpretation cues within the system is an advantage, however the main challenge is in representing this knowledge. Prior data reduction is vital so that only the necessary data is included in the knowledge base to avoid correlation.

The idea of incorporating planning data into the detection process of unplanned developments has been found to be practical and moreover this would enable the process as well to be automated thus enabling planners to address the problem in a timely manner.

In monitoring their trend, three drivers have been tested where one of them is the detected unplanned developments in addition to the transport network and hydrography, etc. More factors which are known to influence the occurrence of this phenomena could be incorporated e.g. social-economic data (demography, employment zones, health centres, etc) in modelling.

Both quantitative and qualitative evaluation should be feasible. This study has shown that, it is possible to draw conclusions from extracted information and some ground truth data based on the visual comparison, polygon-pixel count and kappa index. If the idea is to have some qualitative assessment then visual comparison and polygon-pixel count would serve the purpose. However, if more rigorous assessment is required then the kappa index can be considered. It is important to note that, the results of the assessments should be understood within the context of the methods and the data used for proper interpretation.

In general the requirements for a sustainable urban planning system should encompass:

- A solid and sound database on all aspects of the urban environment so as to facilitate monitoring its evolution over time.
- Sound land law system to ensure land accessibility and security of tenure as well as promote transparency in land allocation issues.
- Adapted technologies should be sustainable and ensure ease in problem solving in all aspects e.g. social-economic, political, environmental, etc.
- A set of agreed indicators should be used as pointers in urban growth control and should be kept up to date so as sound decisions can be realized. The success of applying indicators in general is subject to the availability of both financial and human resources. Furthermore, it is also dependent on the country's national priorities, problems and targets. Thus for sound decision making, any decision support system should incorporate indicators.
- There is increasing need to incorporate the local needs and priorities into the whole urban planning process.

Furthermore urban planning should be viewed as a collective responsibility to ensure success, where all stakeholders participate in the whole process. A mechanism of accessibility and usability of earth observation data should then be established, where issues pertaining to cost, level of detail and accuracy, currency of information and data security should be core

components. This will eventually, promote transparency in the land issues and management of the urban resources.

This study has demonstrated that a 'complete package' that will enable planners to detect and predict the trend of unplanned developments is feasible. A simple system employing information that is in the custody of government institutions in combination with a wealth of data emanating from remotely sensed sources can be exploited to make the already untameable situation tameable. With a proper organizational framework that promotes interdisciplinary, integration and participation of all stakeholders, then realistic policies of sustainable developments can be realized.



## REFERENCES

- AFRICOVER**, 1996. Land Quality and Sustainable Land Management Indicators, <http://www.africover.org/projects.htm>
- Amos J.**, 1993. Planning and Managing Urban Services, *Managing Fast Growing Cities: New Approaches to Urban Planning and Management in the developing world*, pp. 132-152.
- Argialas, P.D., & Harlow, A.C.**, 1990. Computational Image Interpretation Models: An Overview and a Perspective, *Photogrammetric Engineering and Remote Sensing*, 56(6), 871-886.
- Armenakis C. and Savopol F.**, 1998. Mapping Potential of the IRS-1C PAN Satellite Imagery, *GIS between Visions and Applications*, IAPRS, Vol. 32, pp. 23-26, Stuttgart, 1998.
- Batty M. and Longley P.**, 1994: *Fractal Cities: A geometry of form and function*: Acad. Press, -XXI, 394pp.
- Benites J.R. and Tschirley J.B.** 1997. Land quality indicators and their use in sustainable agriculture and rural development. Proceedings of the Workshop Organized by the Land and Water Development Division, FAO Agriculture Department, and the Research, Extension, and Training Division, FAO Sustainable Development Department, 25-26 January, 1996. *FAO Land and Water Bulletin* 5; FAO, Rome, Italy. 212 pp.
- Bolstad, P.V. & Lillesand T.M.**, 1992. Rule-based classification Models: Flexible Integration of satellite imagery and thematic spatial data, *Photogrammetric Engineering and Remote Sensing*, 58(7), 965-971.
- Bondo, S.J.**, 1990. *Fundamentals of Expert Systems Technology; Principals and Concepts*.
- Cappellini V., Chiuderi A. and Fini S.**, 1995. Neural Networks in remote sensing multisensor data processing, *Sensors and Environmental Applications of Remote Sensing*, p. 457-462.
- Chan, J.C-W., Chan, K-P., & Yeh, A.G-O.**, 2001. Detecting the Nature of Change in an Urban Environment: A Comparison of Machine Learning Algorithms, *Photogrammetric Engineering and Remote Sensing*, 67(2), 213-225.
- Chaturvedi P. Er.** 2001. Zoning Atlas for Environmental Siting of District Ghaziabad-A case study. *Urban Sprawl, GIS in urban planning*, GISdevelopment.net
- Chen S., Zeng S. and Xie C.**, 2000. Remote Sensing and GIS for Urban Growth Analysis in China, *Photogrammetric Engineering and Remote Sensing*, 66(5), 593-598.
- Chiu C-S. and P-H. Huang**, 1997. An Evaluation of the Priority of Public Housing Location-Allocation. 1997 ACSM/ASPRS Annual Convention and Exposition Technical Papers, Seattle, Washington, April 1997, vol. 4, 712-718.
- Chuvieco E. and Congalton R. G.**, 1988. Using Cluster Analysis to Improve the Selection of Training Statistics in Classifying Remotely Sensed Data, *Photogrammetric Engineering and Remote Sensing*, 54(9), 1275-1281.

- Clarke, C.K.**, 1997. "Land Transition Modeling with Deltatrons", The Land use modelling Conference, Sioux Falls, <http://www.ncgia.ucsb.edu/conf/landuse 97/>
- Clever J.G.P.W.**, 2000. Remote Sensing Basics, digital lectures (CD); Center for Geo-information, Wageningen University, The Netherlands.
- Congalton, R.G., and R.A. Mead**, 1983. A Quantitative Method to Test for Consistency and Correctness in Photointerpretation, *Photogrammetric Engineering and Remote Sensing*, 49(1), pp.69-74.
- Coulter L., Stow D., Kiracofe B., Langevin C., Chen D., Daeschner S., Service D., and Kaiser J.**, 1999. Deriving Current Land-use information for Metropolitan Transportation Planning through Integration of Remotely Sensed Data and GIS, *Photogrammetric Engineering & Remote Sensing*, 65(11): 1293-1300.
- Dhokal A.S., Amanda T., Aniya M. and Sharma R.R.**, 2002. Detection of Areas Associated with Flood and Erosion Caused by a Heavy Rainfall Using Multitemporal Landsat TM Data, *Photogrammetric Engineering and Remote Sensing*, 68(3), pp.233-239.
- Davey K.**, 1993. The Institutional Framework for Planning and the Role of Local Government, *Managing Fast Growing Cities: New Approaches to Urban Planning and Management in the developing world*, pp. 153-175.
- Davis R., Shrobe H. and Szolovits P.**, 1993. What is a Knowledge Representation? *AI Magazine*, 14(1), pp. 17-33.
- Devas N. and Rakodi C.**, 1993. The Urban Challenge, *Managing Fast Growing Cities: New Approaches to Urban Planning and Management in the Developing World*, pp.1-40.
- Dowman I.**, 1998. Automated Procedures for integration of Satellite Images and Map Data for Change Detection: The ARCHANGEL PROJECT, *GIS between Visions and Applications*, IAPRS, Vol. 32, pp. 162-169, Stuttgart, 1998.
- ERDAS IMAGINE 8.4**, 1999. Tour guides, pp. 479-516.
- Evans M. and Fletcher P.**, 1991: *Remote Sensing and Environmental Monitoring; Remote Sensing of the Environment*, pp. 11-18.
- FAO AFRICOVER PROGRAMME**, 1998. GeoInformatin, Monitoring and Assessment, <http://www.fao.org/sd/eidirect/EIre0053.htm>
- Furtado J.I.R.**, 1991: The Global Environment Facility: Sustainable land use systems and human living conditions in the Amazon region-EUR 14337; pp.67-70
- Fung, T., and E. LeDrew**, 1988. The determination of Optimal Threshold Levels for Change Detection Using Various Accuracy Indices, *Photogrammetric Engineering and Remote Sensing*, 54(10), pp.1449-1454.
- GDTA**, 1995. Book A4 Remote Sensing, *Town and Country Planning*, p. 21-81.

- Gorham B.**, 1997. Monitoring Change in Urban Land Use for the Little Rock (AR) Metropolitan Area or Central Arkansas Growth viewed by Satellite.<http://web.cast.uark.edu/cast/Projects/urban/metroplan.html> (15 July 1997).
- Grove, S.**, 2001. Wissensbasierte Interpretation multitemporaler Luftbilder, Dissertation, Institut für Theoretische Nachrichtentechnik und Informationsverarbeitung, Universität Hannover, Fortschritt-Berichte VDI, Reihe 10, VDI-Verlag, Düsseldorf.
- Gupta R.D., Garg P.K. and Arora M.**, 2001. Analysis of Intra-District Disparities for Dehradun District. Urban Sprawl, GIS in urban planning. GISdevelopment.net
- Haala N., Stallmann D. and Stätter C.**, 1998. On the use of Multispectral and Stereo Data from Airborne Scanning Systems for DTM generation and Land use Classification. GIS-Between Visions and Applications, IAPRS. Vol. 32, Part 4, Stuttgart, p. 203-209.
- Harris P.M. and Ventura S.J.**, 1995. The Integration of Geographic Data with Remotely Sensed Imagery to Improve Classification in an Urban Area, Photogrammetric Engineering and Remote Sensing, 61(8), pp.993-998.
- Heiko B.**, 2001. Applicability of IKONOS-Satellite scenes Monitoring, Classification and Evaluation of Urbanization Processes in Africa – Case Study of Gombe/Nigeria, 2<sup>nd</sup> International Symposium on Remote Sensing of Urban Areas , Regensburg/Germany, Regensburger Geographische Schriften, Heft 35, 25-35
- Heipke C. and Straub B.-M.**, 1999. Towards the automatic GIS update of vegetation areas from satellite imagery using Digital Landscape Models as prior information, IAPRS (32) 3-2W5, 167-174.
- Hinz S., Baumgartner A., Steger C., Mayer H., Eckstein W., Ebner H., and Radig B.** 1999. [Road extraction in rural and urban areas](#). In Wolfgang Förstner, Claus-Eberhard Liedtke, and Jürgen Bückner, editors, *Semantic Modeling for the Acquisition of Topographic Information from Images and Maps*, pages 133-153.
- Hoffmann P.**, 2001: Detecting Informal Settlements from Ikonos Image Data Using Methods of Object Oriented Image Analysis – An Example from Cape Town (South Africa), 2<sup>nd</sup> International Symposium on Remote Sensing of Urban Areas, Regensburg/ Germany, Regensburger Geographische Schriften, Heft 35, 107-115
- ISD**,1997. Indicators for Sustainable Development.  
<http://www.hq.nasa.gov/iwgsdi/Welcome.html>
- Jacobsen K.**, 1997. Geometric Aspects of High Resolution Satellite Sensors for Mapping, 1997 ACSM/ASPRS Annual Convention and Exposition Technical Papers, Seattle, Washington, April 1997, vol. 4, 473-483.
- Jensen, J.R. & Cowen, D.J.**, 1999. Remote Sensing of Urban/Suburban Infrastructure and Socio-Economic Attributes, Photogrammetric Engineering and Remote Sensing, 65(5), 611-622

- Jensen J.R., Cowen D.J., Halls J., Narumalani S., Schmidt N.J., Davis B.A. and Burgess B.,** 1994. Improved Urban Infrastructure Mapping and Forecasting for BellSouth Using Remote Sensing and GIS Technology, *Photogrammetric Engineering and Remote Sensing*, 60(3), 339-346.
- Jesinghaus J.,** 1999. Indicators for Decision-Making, European Commission, JRC/ISIS, TP 361, I-21020 Ispra (VA), [http://esl.jrc.it/envind/idm/idm\\_e.htm](http://esl.jrc.it/envind/idm/idm_e.htm)
- Ji M. and Jensen R.J.,** 1999: Effectiveness of Subpixel Analysis in Detecting and Quantifying Urban Imperviousness from Landsat Thematic Mapper Imagery, *Geocarto International*, Vol. 14, No. 4, December 1999, pp. 33- 41.
- Jürgens C.,** 2000. Change Detection - Erfahrung bei der vergleichenden multitemporalen Satelliten-bildauswertung in Mitteleuropa, *Photogrammetrie Fernerkundung Geoinformation*, 1/2000, 5-18.
- Karanja, F.N. & Lohmann, P.,** 2001. The contribution of GIS and Remote Sensing in Urban Land Use Negotiation in Developing Countries, *Proceedings ISPRS*, Vol. XXXIII, Part B7, pp. 646-653, Amsterdam, 2000.
- Karanja, F.N. & Lohmann, P.,** 2001. Use of Temporal Knowledge in Detecting Unplanned Developments in Urban Areas, 2<sup>nd</sup> International Symposium on Remote Sensing of Urban Areas, Regensburg/ Germany, *Regensburger Geographische Schriften*, Heft 35, 119-128
- Karanja, F.N. & Lohmann, P.,** 2000. The contribution of GIS and Remote Sensing in Urban Land Use Negotiation in Developing Countries, *Proceedings ISPRS*, Vol. XXXIII, Part B7, pp. 646-653, Amsterdam, 2000.
- Kelly M., Estes J.E. and Knight K.A.,** 1999. Image Interpretation Keys for Validation of Global Land-Cover Data Sets, *Photogrammetric Engineering and Remote Sensing*, 65(9), 1041-1049.
- Kilston, S.,** 1996. High Resolution Commercial Remote Sensing Satellites: Their Value for Environmental Monitoring, 1997 ACSM/ASPRS Annual Convention and Exposition Technical Papers, Seattle, Washington, April 1997, vol. 4, 620-629.
- Kim, T-H., V. Devarajan, and M.T. Manry.** 1997. Road Extraction from Aerial Images Using Neural Networks. 1997 ACSM/ASPRS Annual Convention and Exposition Technical Papers, Seattle, Washington, April 1997, vol. 3, 146-154.
- Koch, H., Pakzad, K., & Tönjes, R.,** 1997. Knowledge based interpretation of aerial images and maps using a digital landscape model as partial interpretation, *Semantic Modeling for the Acquisition of Topographic Information from Images and Maps*, SMATI 97, pp. 3-19.
- Konecny G.,** 1999. The impact of high resolution satellite data on the operationalization of remote sensing for mapping from space, ITC Enschede, *Proceeding of ORS Symposium*, in CD.
- Kreimer A. and Zador M.,** 1989. The Impacts of Natural Disasters on the Poor: A BACKGROUND NOTE, *Colloquium on Disasters, Sustainability, and Development, A Look to the 1990s.*" Environment Working Paper 23, Washington, DC,

[www.worldbank.org/html/fpd/urban/dis\\_man/mimi/references.htm](http://www.worldbank.org/html/fpd/urban/dis_man/mimi/references.htm)

**Kunz, D., Schilling, K.-J. & Vögtle, T., 1997.** A new approach for satellite image analysis by means of a semantic network, *Semantic Modeling for the Acquisition of Topographic Information from Images and Maps*, SMATI 97, pp. 20-36.

**Landis, J. & Zhang, M., 1997.** “Modelling Urban Land Use Change: The Next Generation of the California Urban Futures Model”, *The Land use modelling Conference*, Sioux Falls, [http://www.ncgia.ucsb.edu/conf/landuse\\_97/papers/Landis\\_john/paper.html](http://www.ncgia.ucsb.edu/conf/landuse_97/papers/Landis_john/paper.html)

**Lidov L R., Miller D. M. Wormer, and K. A. Tilley, 2000.** Interview: Understanding the Future of Commercial Remote Sensing. *Photogrammetric Engineering & Remote Sensing*, 66(5): 5-14.

**Lillesand T. and Kiefer R.W., 2000.** *Remote Sensing and Image Interpretation*, Fourth Edition, John Wiley & Sons, New York, 724 pages.

**Lorup, E.J., 2000.** IDIRIS Tutorial on WWW, <http://www.sbg.ac.at/geo/idrisi/wwwtutor/tuthome.htm>

**Macleod D.R. and Congalton G.R., 1998.** A quantitative comparison of change detection algorithms for monitoring eelgrass from remotely sensed data, *Photogrammetric Engineering and Remote Sensing*, 4(3): 207-216.

**Maktav D. and Erbek S., 2001.** Analysis of Urban Growth Using Multitemporal Satellite Data in Ý STANBUL, TURKEY, 2<sup>nd</sup> International Symposium on Remote Sensing of Urban Areas, Regensburg/ Germany, *Regensburger Geographische Schriften*, Heft 35, 176-184

**Mason S. and Baltsavias, E 1997:** Image-Based reconstruction of Informal settlements: Automatic Extraction of Man-Made Objects from Aerial and Space Images (II) *Monte Verita*.

**Mehldau, G. & Schowengerdt, A.R., 1990.** A C-Extension for Rule-Based classification Systems, *Photogrammetric Engineering and Remote Sensing*, 56(6), 887-892.

**Meinel, G., Knapp, C., & Tittel, E-V., 1997.** Bestimmung von Flächennutzungsänderungen mittels Satellitenbilddaten – Methodische Untersuchungen am Beispiel der Stadt-Umland-Regionen Dresden und Leipzig, *IÖR-Schrift* 21.

**Meinel G., Lippold R. and Netzband M., 1998.** The Potential use of new high resolution satellite data for urban and regional planning. *GIS-Between Visions and Applications*, IAPRS. Vol. 32, Part 4, Stuttgart, p. 375-381.

**Meinel G., Neubert M. and Reder J., 2001.** The Potential Use of Very High Resolution Satellite Data For Urban Areas-First Experiences with Ikonos Data, Their Classification and Application in Urban Planning and Environmental Monitoring, 2<sup>nd</sup> International Symposium on Remote Sensing of Urban Areas, Regensburg/ Germany, *Regensburger Geographische Schriften*, Heft 35, 196-209

**Meyer G., 1995.** Bericht der Naturhistorischen Gesellschaft Hannover, pp.137

- Middelkoop, H., & Janssen, F.L.L., 1991. **Implementation of Temporal Relationships in Knowledge Based Classification of Satellite Images**, Photogrammetric Engineering and Remote Sensing, 57(7), 937-945.
- Moller-Jensen L.**, 1990. Knowledge-Based Classification of an Urban Area Using Texture and Context Information in Landsat-TM Imagery, Photogrammetric Engineering and Remote Sensing, 56(6), 899-904.
- MURBANDY, 2000.** Monitoring Urban Dynamics, <http://murbandy.sai.jrc.it/description.htm>  
<http://www.eftas.com>
- Nigam R.K.**, 2001. Application of Remote Sensing and Geographical Information System for land use / land cover mapping and change detection in the rural urban fringe area of Enschede city, The Netherlands,  
<http://www.gisdevelopment.net/application/urban/fringe/urbanf0001.htm>
- Nigel H.**, 1991. Cities in the 1990s, Managing Fast Growing Cities.
- Pakzad K.**, 2001. Wissensbasierte Interpretation von Vegetationsflächen aus multitemporalen Fernerkundungsdaten, DGK bei der bayrischen Akademie der Wissenschaften, Reihe C Dissertationen ,Heft 543, München 2001
- Pakzad K., Bückner J. and Growe S., 1999.** Knowledge Based Moorland Interpretation using a hybrid system for image analysis, IAPRS (32) 3-2W5, pp.159-165
- Perdigao V. and Annoni,** 1997. Technical and methodological guide for Updating CORINE Land Cover Database, Joint Research Centre.
- Petrou, M.**, 1999. Mixed Pixel Classification: An overview, Information Processing for Remote Sensing, pp.69-84.
- Pijanowski, B.C., Long, D.T., Gage, S.H., & Cooper, W.E., 1997.** "A Land Transformation Model :Conceptual Elements, Spatial Object Class Hierarchies, GIS command Syntax and an Application for Michigan's Saginaw Bay Watershed", The Land use modeling Conference, Sioux Falls,  
[http://www.ncgia.ucsb.edu/conf/landuse\\_97/papers/pijanowski\\_bryan/paper.html](http://www.ncgia.ucsb.edu/conf/landuse_97/papers/pijanowski_bryan/paper.html)
- Pohl, C. & Genderen, J.L. VAN,** 1998. Multisensor image fusion in remote sensing: concepts, methods and applications, International Journal of Remote Sensing, Vol. 19, No. 5, pp. 823-854.
- Rosenfield, G.H., and K. Fitzpatrick-Lins,** 1986. A Coefficient of Agreement as a Measure of Thematic Classification Accuracy, Photogrammetric Engineering and Remote Sensing, 52(2), pp.223-227.
- Ruas, A,** 1995. "Multiple Paradigms for Automating Map Generalization: Geometry, Topology, Hierarchical Partitioning and Local Triangulation." *ACSM/ASPRS Annual Convention & Exposition Technical Papers*. Bethesda: ACSM/ASPRS, 1995. 4:69-78.
- Saxena A.**, 2001. Monitoring of Urban Fringe Areas Using Remote Sensing and GIS Techniques, GIS in Urban Planning, GIS Development.



<http://www.gisdevelopment.net/application/urban/fringe/urbanf0004.htm>

**Schenk T.**, 1999. Digital Photogrammetry, Background, Fundamentals, Automatic Orientation Procedures, Vol. I, pp. 41-73.

**Schenk T. and Zilberstein O.**, 1990. Experiments with a Rule-Based System for Interpreting Linear Map Features, *Photogrammetric Engineering and Remote Sensing*, 56(6), pp.911-917.

**Serpico S.B. and Bruzzone L.**, 1999: Change Detection, Information Processing for Remote Sensing, by World Scientific Publishing C., Pte. Ltd, pp. 317-336

**Sersland C.A., Johnston C.A. and Bonde J.**, 1995. Assessing Wetland Vegetation with GPS-linked Color Video Image Mosaics, Proceedings of the 15<sup>th</sup> Biennial Workshop on Color Photography and Videography in Resource Assessment; American Society for Photogrammetry and Remote Sensing, Bethesda, MD, pp. 53-62.

**Stefan H.**, 2001. Using Context as a Guide for automatic object extraction in urban areas, 2<sup>nd</sup> International Symposium on Remote Sensing of Urban Areas, Regensburg/ Germany, Regensburger Geographische Schriften, Heft 35, 89-99

**Sui, D.Z.**, 1997. "The Syntax and Semantics of Urban Modeling: Versions vs. Visions", The Land use Conference, Sioux Falls,

[http://www.ncgia.ucsb.edu/conf/landuse97/papers/sui\\_daniel/paper.html](http://www.ncgia.ucsb.edu/conf/landuse97/papers/sui_daniel/paper.html)

**Sunar F., Örmeci C., Kaya S. and Musaoglu N.**, 1996. Assessment of multitemporal land use/cover changes using remotely sensed imagery; A case study: Tuzla region in Istanbul, Turkey, *International Archives of Photogrammetry and Remote Sensing*, Vol. XXXI, Part B7, Vienna 1996, p. 678-682

**Thiam A.K.**, 2000. RSCE, Change Detection Exercise: Crossclassification, Volume 3, Introductory Digital Image Processing,

<http://www.cla.sc.edu/GEOG/rslab/rscnew/mod8/exercises/CROSSCLASS.htm>

**Tönjes R., Growe S., Bückner J. and Liedtke C-E.**, 1999. Knowledge-Based Interpretation of Remote Sensing Images Using Semantic Nets, *Photogrammetric Engineering and Remote Sensing*, 65(7), 811-821.

**Treitz P.M., Howarth P.J. and Gong P.**, 1992. Application of Satellite and GIS Technologies for Land-Cover and Land-Use Mapping at the Rural-Urban Fringe: A Case Study, *Photogrammetric Engineering and Remote Sensing*, 58(4), 439-448.

**UMP**, 1992: Urban Applications of Satellite Remote Sensing and GIS Analysis, The World Bank, Washington D.C.

**UNITED NATIONS ECONOMIC FOR AFRICA**, 1998: An integrated Geo-Information (GIS) with emphasis on cadastre and land information systems (LIS) for decision makers in Africa.

**UNHCS**, 1999. Informal Settlements, Security of Tenure, Urban Land Management, and Local Governance, Experiences in implementing the Habitat Agenda.

UNCHS, 2001: Urban Indicators; [www.unchs.org/programmes.html](http://www.unchs.org/programmes.html)

U.S. EPA, 2000: **Projecting Land-Use Change: A summary of Models for Assessing the Effects of Community Growth and Change on Land-Use Patterns.** EPA/600/R-00/098. U.S. Environmental Protection Agency, Office of Research and Development, Cincinnati, OH. 260pp.

**Van Gool, L., P. Dewaele, and A. Oosterlinck**, 1985. Texture Analysis Anno 19983. Computer Vision, Graphics and Image Processing, Vol. 29, pp. 336-357.

**Van Zee, C.J. and P. Hayes**, 1997. Urban Watershed GIS Models for Neighborhood Environmental Education. 1997 ACSM/ASPRS Annual Convention and Exposition Technical Papers, Seattle, Washington, April 1997, vol. 4, 476.

**Wang F.**, 1993. A Knowledge-Based Vision System for Detecting Land Changes at Urban Fringes, IEEE Transactions on Geoscience and Remote Sensing, Vol. 31(1), pp. 136-146.

**Westin T., Rosenholm D. and Dahlberg M.**, 1988. Topographic Mapping from SPOT over Asela, Ethiopia - A Case Study: Presented at the 22<sup>nd</sup> International Symposium on Remote Sensing of Environment, Abidjan, Cote d'Ivoire.

**Westmoreland S. and Stow D.A.**, 1992. Category Identification of Changed Land-Use Polygons in an Integrated Image Processing/Geographic Information System, Photogrammetric Engineering and Remote Sensing, 58(11), 1593-1599.

**Wood, E.C., Lewis, J.E., Tappan, G.G. & Lietzow, R.W.**, 1997. "The Development of a Land cover change model for Southern Senegal", The land use Conference, Sioux Falls, [http://www.ncgia.ucsb.edu/conf/landuse\\_97/papers/wood\\_eric/paper.html](http://www.ncgia.ucsb.edu/conf/landuse_97/papers/wood_eric/paper.html)

**Yeh A. Gar-On and Li X.**, 2001. Measurement and Monitoring of Urban Sprawl in a Rapidly Growing Region Using Entropy, Photogrammetric Engineering and Remote Sensing, 67(1), 83-90.

**You Z. and Jain A.K.**, 1984: Performance Evaluation of Shape Matching via Chord Length Distribution. Computer Vision, Graphics and Image Processing, Vol. 28, pp. 185-198.

**Zenk, S.**, 2000. Vergleich verschiedener Verfahren zur Erkennung von Änderungen in multispektralen Luftbildern städtischer Gebiete, CENSIS-REPORT-35-00.

**Zhang, Y.**, 1998. Detection of Urban Housing Development Using Multisensor Satellite Data and Maps. International Archives of Photogrammetry and Remote Sensing, Vol. 32, Part 3/1, pp. 292-299.



## **APPENDIX**

## CURRICULUM VITAE

### PERSONAL DATA

NAME: **KARANJA, FAITH NJOKI.**  
MAIDEN NAME: **KAMIRU, FAITH NJOKI.**

ADDRESS: CURRENT:  
INSTITUTE FOR PHOTOGRAMMETRY AND  
GEOINFORMATION  
UNIVERSITY OF HANNOVER  
NIENBURGER STR. 1  
30167 HANNOVER  
GERMANY

TEL: ++49-511/76219953  
FAX: ++49-511/762-2483  
E-mail: [karanja@ipi.uni-hannover.de](mailto:karanja@ipi.uni-hannover.de)

PERMANENT:  
DEPARTMENT OF SURVEYING  
UNIVERSITY OF NAIROBI  
P.O. BOX 30197  
NAIROBI  
KENYA

TEL: ++254-72747903; ++254-15121261  
E-mail: [faithkaranja@hotmail.com](mailto:faithkaranja@hotmail.com)

DOB: 31.12.68

NATIONALITY: KENYAN

GENDER: FEMALE

MARITAL STATUS: MARRIED

### EDUCATION

From April 1999-present UNIVERSITY OF HANNOVER, GERMANY  
Institute of Photogrammetry and GeoInformation  
PhD Research Topic: **Use of Knowledge Based Systems for the Detection and Monitoring of Unplanned Developments.**  
Keywords: Remote Sensing, GIS, Digital Image Processing, Knowledge based-Image Interpretation and Urban Growth Simulation

1994-1996 UNIVERSITY OF NAIROBI, KENYA  
 Department of Surveying  
 Graduated with a Masters degree, MSc (Surveying)

1992-1993 UNIVERSITY OF NAIROBI, KENYA  
 Institute of Computer Science  
 Graduated with a Post-Graduate Diploma in (Computer Science)

1988-1991 UNIVERSITY OF NAIROBI, KENYA  
 Department of Surveying  
 Graduated with a Bachelors degree, BSc(Surveying)

### **WORK EXPERIENCE**

Nov. 1997-PRESENT **UNIVERSITY OF NAIROBI, NAIROBI KENYA**  
 DEPARTMENT OF SURVEYING  
 ASSISTANT LECTURER

1991-Nov. 1997 **UNIVERSITY OF NAIROBI, NAIROBI KENYA**  
 DEPARTMENT OF SURVEYING  
 TEACHING ASSISTANT

Sept. – Oct., 2000 UN Experience: ECA-PROJECTS AS A CONSULTANT,  
 Addis Ababa, Ethiopia.

- Assisted in the preparation of an Africa Land Information System-Workshop to be co-sponsored by GTZ and ECA.
- Conceptualization and Formulation of two Pilot projects namely:
  - Visualization aspects of Land Information Systems
  - Success GIS stories in Africa.

### **LANGUAGES**

Mother tongue: Kikuyu  
 National Language: Kiswahili  
 English: Fluent in written and verbal  
 German: Fluent in written and verbal