

3rd International Conference on System-integrated Intelligence: New Challenges for Product and Production Engineering, SysInt 2016

## Direct Part Marking by Vibration Assisted Face Milling

Berend Denkena<sup>a</sup>, Thilo Grove<sup>a</sup>, Alexander Seibel<sup>a,\*</sup>

<sup>a</sup> *Institute of Production Engineering and Machine Tools, Leibniz Universität Hannover, Germany*

---

### Abstract

Critical or safety components have to be identified during maintenance especially if exposed to harsh conditions during the time of operation. Direct part marking (DPM) is a process to permanently mark parts with product information such as serial numbers, part numbers, date codes and barcodes. An advanced machining technology is presented (vibration assisted face milling, VAFM), enabling the machining of Data Matrix Codes (DMC) and similar shapes carrying inherent data into the components surface without any additional process step. The technology is based on a piezo-electrically driven milling tool. The dynamics of the tool enable a highly dynamic and controlled depth of cut variation during the cutting process while using process parameters applied in real-life industrial processes. As an example for safety components, the technology is demonstrated on TiAl6V4, one of the most important titanium alloys in the aerospace industry. The machined result is evaluated on the machining quality of the DMC data cells edges and the contrast.

© 2016 Published by Elsevier Ltd. This is an open access article under the CC BY-NC-ND license (<http://creativecommons.org/licenses/by-nc-nd/4.0/>).

Peer-review under responsibility of the organizing committee of SysInt 2016

*Keywords:* direct part marking, dmp, data matrix code, dmc, machining, fast tool servo, fts, face milling, vibration assisted face milling, vafm

---

### 1. Introduction

Direct part marking (DPM) is a process to permanently mark parts with product information such as serial numbers, part numbers, date codes and barcodes. Information encoded in 2-dimensional barcodes such as QR-Codes or Data-Matrix-Codes (DMC) are used in a wide array of industries to identify and trace parts during manufacturing and their lifetime [1]. Especially system-critical or safety relevant components in the automotive or aerospace industry are predestinated for DPM as they often undergo maintenance procedures or have to be identified in case of an unexpected

---

\* Corresponding author. Tel.: +49-511-76218234; fax: +49-511-7625115.  
*E-mail address:* [seibel@ifw.uni-hannover.de](mailto:seibel@ifw.uni-hannover.de)

failure. For the most part, such components are made out of metal and can be exposed to harsh conditions such as heat, chemicals and/or abrasive contacts during their time of operation. For such conditions the data cells in the DMC matrix have to be marked in a robust way, for example as contrast structures within the surface or as a colourization. Various technologies exist to mark metal parts. The most frequently used ones are laser etching, chemical etching and dot peening [1, 2] (Fig. 1). They all have in common that they require an additional step in the manufacturing process chain and a specialized machine which is designed only for this purpose.

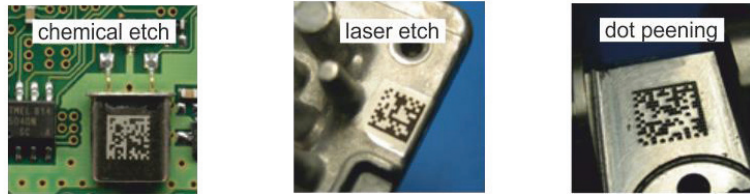

Fig. 1. Common methods for marking metal parts with DMC's [1]

In this paper a machining based marking technology is demonstrated to enable the storage of information in form of Data-Matrix-Codes (or similar shapes) during a conventional face milling process. This technology is based on the vibration assisted face milling process (VAFM), enabling the machining of microstructures in various shapes on flat metal workpiece surfaces [3]. A big advantage of this technology, over existing marking technologies, is that it can be used on conventional CNC milling centres on any flat metal workpiece surface during the finishing process step. This is made possible with a piezo actuator based face milling tool, developed within the Collaborative Research Centre (CRC) 653 [4]. The initial intention of the development of this tool was to machine microstructures, representing binary information, similar to a CD (Fig. 2). This approach was successfully demonstrated in [5], however this type of data storage is not an industry standard like Data-Matrix-Codes and requires specialized reading and decoding technology. The research focuses of the CRC653 are innovative component properties and concepts for their manufacturing and implementation in production engineering processes. One of the CRC's visions is the inherent storage of significant component information, such as production date, process parameters, process forces or even production drawings on the component itself [6]. In addition, these advanced properties provide an excellent basis for protection of components against plagiarism. To demonstrate this novel marking technology, DMC's varying in size and cell contrast enhancing features, are machined with process parameters used in real-life industrial process on TiAl6V4. The result is then evaluated on the machining quality of the DMC data cells edges and the contrast.

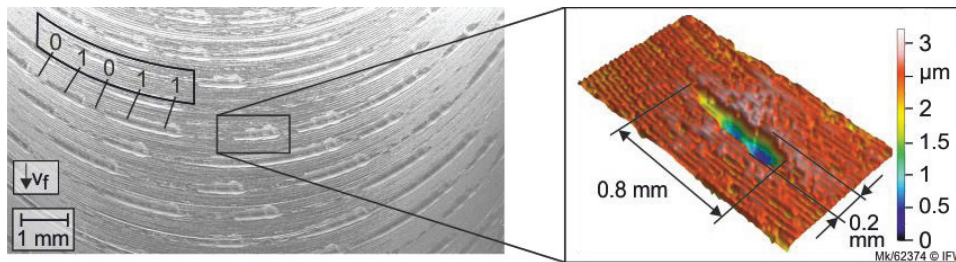

Fig. 2. Machined binary patterns for information storage on metal surfaces [3]

## 2. Vibration assisted face milling of data matrix codes

### 2.1. Tool design

Machining of micro-structures requires highly dynamic tool movements as well as a high stiffness. Thus, the presented fast tool servo (FTS) is actuated by a piezoelectric element. Due to the fact that highly dynamic operations cause a significant heat development, a ring-actuator is used for a better heat dissipation. At the maximal used voltage

of  $U_{max} = 500$  V, the actuator has a force of 10 kN and a travel range of  $\Delta l_{max} = 30$   $\mu\text{m}$ . The controlled cutting of micro structures requires oscillation frequencies below the eigenfrequency due to occurring phase shifts above this frequency range. The moving mass must therefore be as small as possible. For an active positioning in axial direction, the piezo ring-actuator is placed between a tool holder and a frame. The tool holder is mounted with two flexure hinges designed as steel spring membranes. The flexure hinges themselves are attached to the frame. By means of this type of bearing, only one degree of freedom – namely the translation in axial direction – is possible for the tool holder. For the integration into conventional milling machines, a standard spindle connection (DIN 69893 HSK-A 63) for milling spindles is considered. The realization of the piezo-actuated tool is shown in Fig. 3. In order to reduce the moving mass, the tool holder is made of titanium. End mills with screw-in threads, up to a diameter  $d = 20$  mm, can be mounted into the tool holder. Since piezo actuators can only generate a force in one direction, the actuator is preloaded by a central disc spring assembly. The preload can be implemented centrally through the ring-actuator. Beside a good heat dissipation, the ring-actuator offers the advantage of a central preload. This is important with regard to the imbalance of the FTS during rotation.

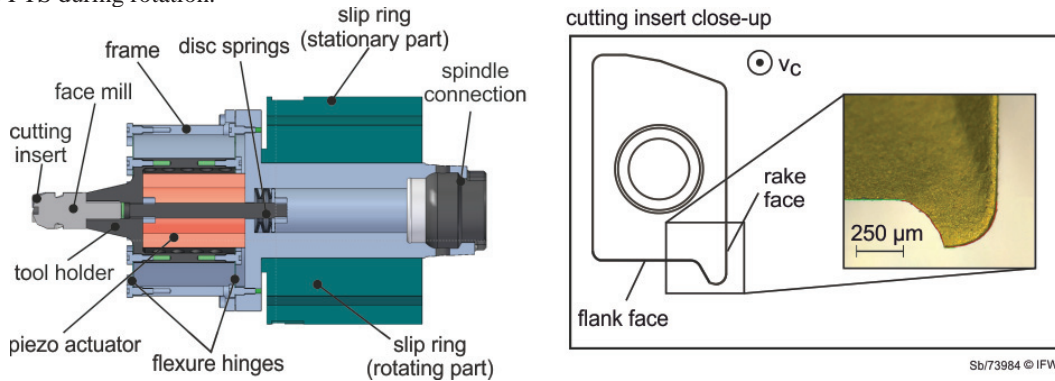

Fig. 3. Sectional view of the piezo-actuated tool for milling operations

2.2. Process kinematics

The face milling of micro structures is performed by a single tooth face milling operation with a high dynamic movement of the end mill along the rotatory axis (Fig. 4a). This movement results in a modulation of the depth of cut  $a_{p,struct}$  in the range of the possible piezo deflection  $\Delta l_{max}$ . The modulation is performed according to a pre-calculated piezo excitation signal, generated by a control system and is dependent on the angular spindle position  $\varphi$ .

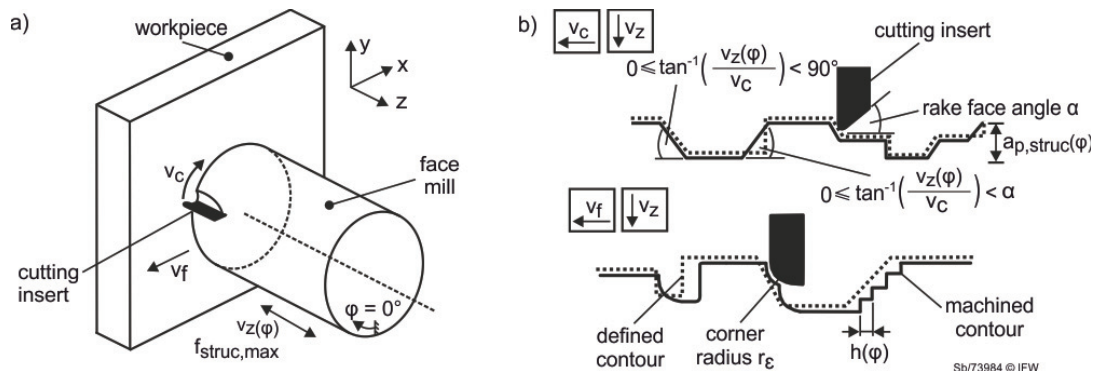

Fig. 4. (a) Tool engagement and kinematics (b) Theoretical differences and limitations between defined and machined contours

The generated microstructure accuracy depends primarily on the macro geometry of the cutting edge, feed per tooth  $f_z$  and the ratio between the speed in axial movement  $v_z$  direction and the cutting speed  $v_c$ , as shown in Fig. 4b. The maximal axial velocity  $v_z$  in up and down direction can differ due to different balance of forces in expansion or shrinking state of the piezo. These stated constraints can result in non-symmetric structuring behavior.

To guarantee that the generated contour along a feed lane is not damaged by the flank face over the following feed steps, a change of the flank face geometry is necessary. A solution for this is to grind the flank face in form of a bar, as shown in a close up in Figure 3. The width of the bar limits the minimal distance between two structure edges in feed direction.

2.3. Tool control

In order to machine structures representing DMC with a defined quality into the surface, data processing and tool control is of significant importance. In the beginning a black/white image of the DMC has to be transformed into a structuring matrix. This matrix contains the deflection signals for each feed step depending on the angular tool tip position (Fig 5b). The matrix size is predefined by the maximal deflections per revolution, cutting speed and feed. Following this, a Matlab/Simulink model processes the matrix along with the information of the angular tool position during the process. It is necessary to handle these signals in real time, to avoid inaccuracies due to varying response times. Therefore, a dSpace real-time computer system is used to run the model. The system's sampling frequency of  $f_s = 40$  kHz is set to decouple the maximum tool vibration frequency of  $f_{struc} = 4$  kHz and to gain satisfying results regarding the processing load and smooth tool tip movements. There is no closed loop position control implemented yet. The amplified signal leads to a defined oscillation of the piezo actuator and therefore of the cutting edge. Fig. 5a illustrates the described tool control.

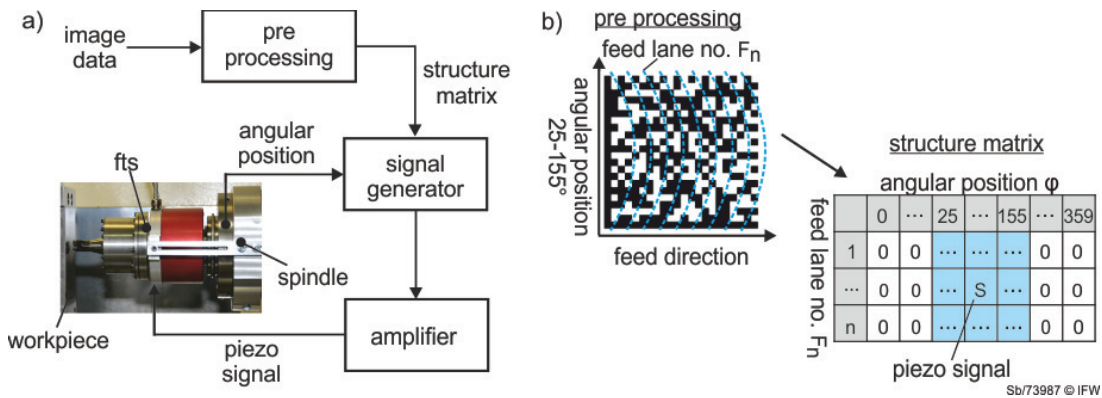

Fig. 5. (a) Control system and data processing sequence (b) concept of the structure matrix

3. Experiments

3.1. Experimental design

To demonstrate the capabilities of this method in regard of process time and size as well readability relevant aspects, the DMC shown in Fig. 6 was machined under different process parameters (Table 1), sizes and cell contrast enhancing features on a 5-axis milling center DMU 125P duoBlock. The workpiece material was TiAl6V4. As cutting insert SECO XOMX060202 was used with a special preparation of the rake face as previously mentioned (Fig. 1) (Table 2). In previous experiments with this structuring method [3], some machining quality relevant factors could already be identified. Based on this, the varied cell edge quality relevant process parameters are feed rate  $f$  and the ratio of  $v_c/v_z$ . The maximal velocity in axial direction  $v_z$  is defined by the value of the maximal excitation (structuring) frequency  $f_{struc}$  and the sampling frequency  $f_s$  of the real time system. The objectives of these experiments are to cover accuracy

of the machining process which may have influences on readability and decoding relevant aspects as stated in [7]. Simplified, these aspects describe the shape accuracy of the grid and the data cells and contrast, reflection and defect issues.

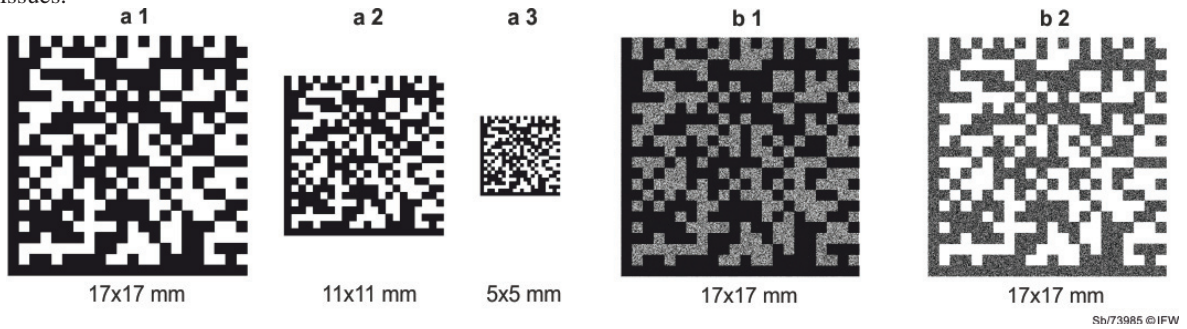

Fig. 6. To be machined DMC's (a) for size and process parameter influence evaluation and (b) contrast enhancing features

Table 1. Process parameters

parameter set	cutting speed $v_c$ [m/min]	width of cut $a_e$ [mm]	depth of cut $a_p$ [mm]	max. excitation freq. max. $f_{sturf}$ [Hz]	feed per tooth $f_z$ [mm]	excitation amp. $a_{p-sturf}$ [ $\mu$ m]
A	15.1	20	0.2	4000	0.066	30
B	37.7	20	0.2	2000	0.02	30

Table 2. Cutting tool parameters

cutting insert geometry	tool diameter d [mm]	number of teeth z [-]	Corner radius $r_e$ [mm]	Bar width $b_w$ [mm]
Seco XOMX060202	20	1	0.2	0.25

### 3.2. Results

The machined surfaces were measured optically with a confocal microscope NanoFocus  $\mu$ Surf with a 10x lens. The measured data was post processed with a 3x3 median denoising filter to remove measurement outliers. Afterwards the surface was leveled and a 7x7 median smoothing filter was applied to reduce micro roughness. The evaluation, based on confocal measuring method was chosen to evaluate the machining accuracy of the proposed method in the first place. A prediction of the readability of the machined DMC can only be deduced to some extent. The following Figures 7 and 8 show a close up of approximately a quarter of each measured DMC to display the edges with more detail. The red lines represent the ideal shape of the data cells for comparison.

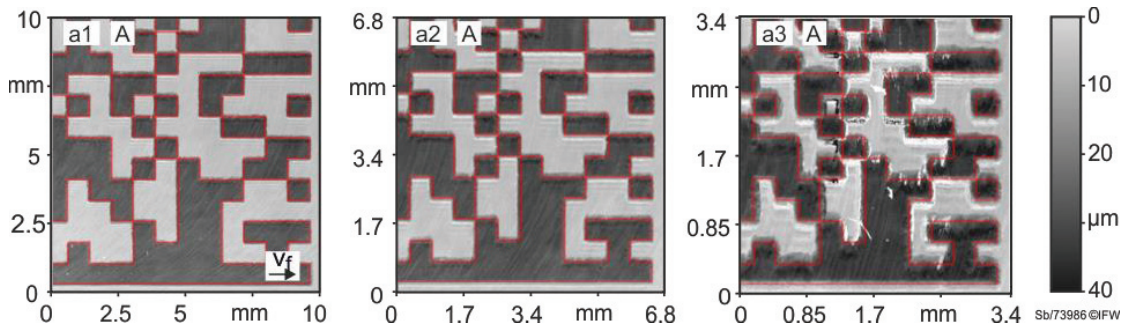

Fig. 7. Machined result with parameter set A

The measurement of the machined DMC a1 with parameter set A (Fig. 7) shows an almost perfect match between machined and ideal shape. Only small inaccuracies in the form of an edge skewness in cutting direction is noticeable. This inaccuracy is increasing with smaller DMC sizes a2 and a3. However, the skewness has always nearly the same size. Just the ratio between skewness size and cell size is increasing. In a3 the machined cell size is getting noticeably smaller, not only in cutting direction but in feed direction as well (the bright white spots are measurement errors). This effect is similar to the “print growth” described in [7]. It can be tolerated to some extent by advanced reading and decoding systems. No other distortions are visible.

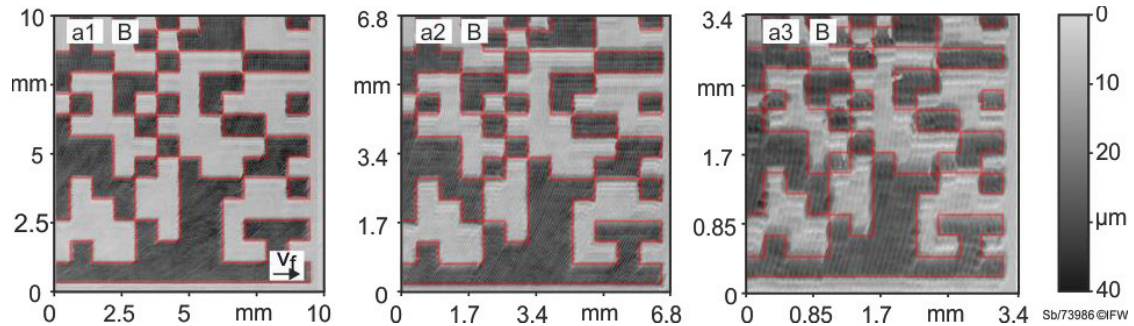

Fig. 8. Machined result with parameter set B

The DMC's machined by parameter set B (Fig. 8) show similar quality effects as with A. The major difference is a higher velocity in feed direction, resulting in a faster machining. Although the feed lanes are more distinct, the shape accuracy and especially the edge skewness in feed direction is just slightly affected in comparison to parameter set A. The highest inaccuracy regarding the ideal shape is still influenced by the cutting velocity  $v_c$  in relation to axial velocity  $v_z$  which is a consequence of the maximal structuring frequency  $f_{struc}$ .

For contrast evaluation between data and non-data cells, the machined DMC's (a1, b1, and b2, machined with parameter set A) were recorded with a conventional digital camera. Only daylight was used as a light source. The angle between camera and workpiece was set in a way that a minimum of reflection was noticeable for each DMC. No additional post processing was performed. The recorded images are shown in Fig. 9.

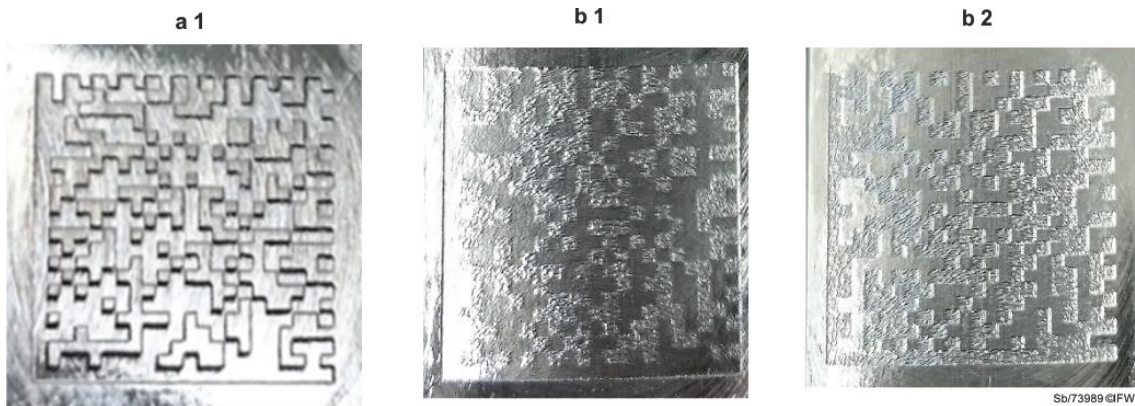

Fig. 9. Images of DMC a1, b1 and b2 taken by a conventional digital camera

It is clearly visible that all three DMC show strong viewing angle dependent reflections with a low contrast of the data cells. In addition, due to the nature of the face milling process, the reflections are non-uniformly distributed along the width of cut. This quality effect can be described as “modulation” [7]. Depending on the light angle the cell edges

in a1 show a strong contrast, but it is not fully possible to distinguish between data and non-data cells. The approach to increase the contrast with DMC b1 and b2 by Gaussian noise, shows an improvement over a1 however not sufficient enough to completely eliminate the non-uniformity of the reflections. In theory due to the error correcting features of the DMC, it can still be decoded when some areas are missing. However without a specialized image recording, processing and encoding system a statement can not be made on the readability.

#### 4. Conclusion

In this article the method of vibration assisted face milling was demonstrated for direct part marking (DPM) by machining Data-Matrix-Codes (DMC). The major advantage over existing part marking technologies is, that this method can be used during the surface finishing process step on a conventional CNC milling center. Focus on the conducted experiments was to machine DMC's with different speed affecting process parameters, DMC sizes and additional contrast enhancing features. The evaluation in terms of shape accuracy shows that the primarily quality affecting factor is the ratio between cutting and axial velocity, resulting in a noticeable edge skewness and therefore smaller data cell sizes similar to the quality aspect known as "print growth" for other marking technologies. Regarding marking speed or in this case machining speed, the factor feed velocity had a less significant impact on the shape accuracy. Due to the nature of the face milling process, the machined surfaces show strong viewing angle dependent reflections, resulting in low contrast between data and non-data cells even with contrast enhancing features. Regarding the readability and therefore the suitability for a possible industrial use, additional experiments have to be conducted with industry grade reading and decoding technology to be able to deduce possible improvements in contrast enhancing features.

#### Acknowledgements

The presented investigations were undertaken with support of the German Research Foundation (DFG) within the Collaborative Research Centre (CRC) 653 "Gentelligent Components in their Lifecycle". The authors would like to thank the DFG for its financial and organizational support of this project.

#### References

- [1] Connolly, C. Part-tracking labelling and machine vision. *Assembly Automation* 2005;25/3:182-187
- [2] Microscan Systems Inc.. Overview of Direct Part Marking Solutions for Various Applications. Technology White Paper; 2011
- [3] Köhler J, Seibel A. FTS-based face milling of micro structures. *Procedia CIRP* 2015;28:58-63
- [4] Denkena B, Köhler J, Mörke T, Gümmer O. High-Performance Cutting of Micro Patterns, *Procedia CIRP* 2012;1:144-149
- [5] Denkena B, Ostermann J, Breidenstein B, Mörke T, Spitschan B. Advanced machining and accessing of information by means of gentelligent micro patterns, 1st Joint International Symposium on System-Integrated Intelligence; 2012
- [6] Denkena B, Henning H, Lorenzen LE. Genetics and intelligence: new approaches in production engineering. *Prod. Eng. Res.* 2010;4/1:65-73
- [7] ISO/IEC 15415:2005. Automatic identification and data capture techniques - Bar code print quality test specification - Two-dimensional symbols