

Analysis of experimental biosensor/FIA lactose measurements

L.S.Ferreira^I; M.B.Souza Jr^I; J.O.Trierweiler^{II}; B.Hitzmann^{III}; R.O.M.Folly^I

^IDepartamento de Engenharia Química, Escola de Química, Universidade Federal do Rio de Janeiro, Cx. P. 68542, 21949-900, Rio de Janeiro, RJ, Brazil

^{II}Departamento de Engenharia Química, Universidade Federal do Rio Grande do Sul, Porto Alegre, RS, Brazil

^{III}Institute for Technical Chemistry, University of Hannover, Hannover, Germany

[Address to correspondence](#)

ABSTRACT

Whey is an abundant effluent in the production of cheese and casein. The biotechnological utilization of this economically important and nutritive source is limited mainly because of the presence of high percentages of lactose. This disaccharide has poor solubility, which can cause crystallization and insufficient sweetness in dairy food; additionally, part of the adult population suffers from associated lactose intolerance diseases. There are several methods to determine lactose such as spectrophotometry, polarimetry, infrared spectroscopy, titrimetry and chromatography. However these methods are tedious and time-consuming due to long sample preparation. These disadvantages stimulated the development of an enzymatic lactose biosensor. It employs two immobilized enzymes, β -galactosidase and glucose oxidase and the quantitative analysis of lactose is based on determination of oxygen consumption in the enzymatic reaction. The influence of temperature on the biosensor signal was experimentally studied. It was observed that a nonlinear relationship exists between the electric response of the biosensor – provided by CAFCA (Computer Assisted Flow Control & Analysis - ANASYSCON, Hannover) - and lactose concentration. In this work, attempts were made to correlate these variables using a simple nonlinear model and multilayered neural networks, with the latter providing the best modeling of the experimental data.

Keywords: Biosensor, FIA, neural networks, β -galactosidase.

INTRODUCTION

Both traditional and modern methods of cheese manufacture produce a large amount of cheese whey (about 83% of the entire volume of milk used). Due to the high concentration of organic substances, mainly lactose and proteins (70% and 20% of total solids, respectively), cheese whey causes values of biochemical oxygen demand (BOD) in wastewater treatment plants to be high, varying from 30,000 to 60,000 mg/L (Ponsano & Castro-Gómez, 1995). The biotechnological utilization of this valuable feedstock is largely limited by lactose due to its poor solubility, insufficient sweetness and the problem of lactose intolerance. Hydrolysis of lactose to glucose and galactose by β -galactosidase (commonly known as lactase) would overcome some of these limitations and permit greater usage of whey (Szczerzak, 2000), including enzyme production.

Routine analysis in the food industry and the on-line control of bioprocesses require determination of several compounds in a fast and trustworthy way. Often these measurements are carried out by gas chromatography, high performance liquid chromatography, thin layer chromatography, enzymatic reactions or colorimetric determinations, but these analyses are time-consuming and require off-line procedures. During the past years, the development of flow injection analysis (FIA) and biosensors (Vega et al., 1998; Liu et al., 1998; Salgado et al., 1997; Liu and Li, 2000; Pasco et al., 1999; Folly et al., 1996) have contributed to reducing these difficulties.

On-line analysis can be done in two different ways: in-situ and ex-situ. In the first case, the sensor is taken to the sample, while in the second, the sample is taken to the sensor. If the sensors can not be sterilized or should be recalibrated or changed frequently, the second type is more highly recommended. The sample can be pumped continuously to the sensor (continuous flow analysis, CFA) or sequentially analyzed by injecting a defined sample volume into a buffer carrier flow that carries the sample to the sensor (flow injection analysis, FIA) (Scheper et al., 1994).

Several lactose biosensors are described in the literature. [Table 1](#) describes some of them.

Table 1: Some contributions from the literature on lactose biosensors

Analytes	Biological Component	Detector	Measurement Range (g/L)	Reference
lactose	β -galactosidase and glucose oxidase	H ₂ O ₂ electrode	Up to 17	Pfeiffer et al. (1990)
lactose and glucose	β -galactosidase, mutarotase and glucose oxidase	Oxygen electrode	20 - 62	Watanabe et al. (1991)
lactose	β -galactosidase and glucose oxidase	Screen-printed electrode	0 - 1.6	Jäger and Bilitewski (1994)
lactose	β -galactosidase and galactose oxidase + NAD as a cofactor	Field Effect Transistor	0 - 0.5	Kullick et al. (1994)
lactose	β -galactosidase and <i>Saccharomyces cerevisiae</i>	CO ₂ electrode	Not known	Amárita et al. (1997)
Glucose, sucrose or lactose	<i>Gluconobacter oxydans</i> , <i>Saccharomyces cerevisiae</i> and <i>Kluyveromyces marxianus</i>	Oxygen electrode	0 - 1.4	Švitel et al. (1998)
lactose	A - β -galactosidase and galactose oxidase B - β -galactosidase and glucose oxidase C - β -galactosidase, galactose oxidase and glucose oxidase	H ₂ O ₂ electrode	0.3 - 1.7 0.7 - 3.4 0.3 - 1.7	Adányi et al. (1999)

Implementation of an automatic FIA system requires coordination of many components, such as mechanical and electronic devices (e.g. pumps, valves, transducers); a reaction which generates a suitable signal (e.g. biocatalysts, such as enzymes, antibodies); and a special program for monitoring and controlling each component of the system (Vega et al., 1998).

In this work, an enzymatic biosensor is studied for further use in the monitoring of substrate consumption during the production of lactase by *Kluyveromyces marxianus* from cheese whey. Lactase from that yeast was classified as GRAS – generally recognized as safe in 1977 (Holsinger and Kligerman, 1991). This biosensor is composed of two enzymes, β -galactosidase and glucose oxidase, and its enzymatic reaction can be seen below:

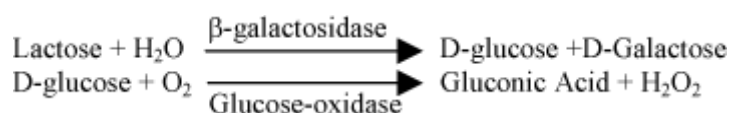

According to the equations above, the respective oxygen consumption is reliably monitored with a standard oxygen detector.

In order to use these biosensors, they must be calibrated. Temperature is shown to have a strong influence on them. Nonlinear models are used to interpret the biosensor signals.

MATERIALS AND METHODS

Catalytic Component, Cartridge and Reagents

The cartridge was obtained from ANASYSCON (Hannover, Germany). All other chemicals were of analytical grade and were from Fluka, Merck and Riedel-de-Haën.

Apparatus and Software

The FIA system consisted of a Cole Parmer multichannel pump, a selector and injection valves from Knauer. A Clark-type oxygen electrode and amplifiers were also used. FIA tubes had an internal diameter of 0.8 mm, except for the sample loop, which was 0.5 mm.

The system was controlled by CAFCA software (ANASYSCON, Hannover, Germany), a software that fully automates the control system, performing the sampling uptake and evaluating the biosensor signals. CAFCA runs in MS-DOS mode with a AX5210 A/D card. The temperature was measured just after the oxygen electrode by a sensor type SEMI 833 ET. Phosphate buffer pH 5.8 (K_2HPO_4 – 1.1 g/L, NaH_2PO_4 – 5.3 g/L, KCl – 1.8 g/L and EDTA – 1.5 g/L) was used as the carrier solution (Vega et al, 1998). A scheme is shown in [Figure 1](#).

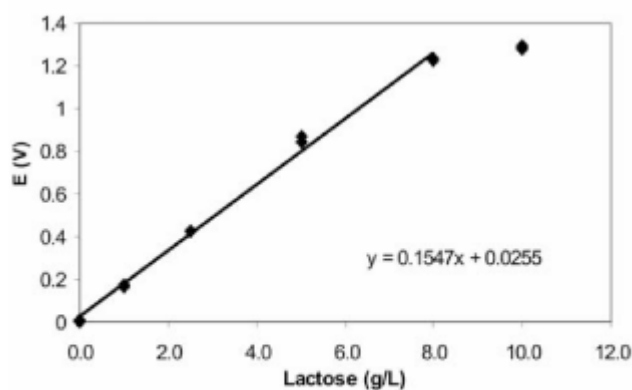

Figure 1: Calibration curve for lactose measurements

RESULTS AND DISCUSSION

Calibration Curve

Standard lactose solutions (1.0, 2.5, 5.0, 8.0 and 10 g/L) were used. Each experiment was conducted three times. The injection volume was 25 μ L and the flow rate was 2.0 mL/min. The temperature of the system was 20°C.

As can be seen in [Figure 1](#), for a lactose concentration range up to 8 g/L, there is a linear output. A scheme of the measurements is shown in [Figure 2](#).

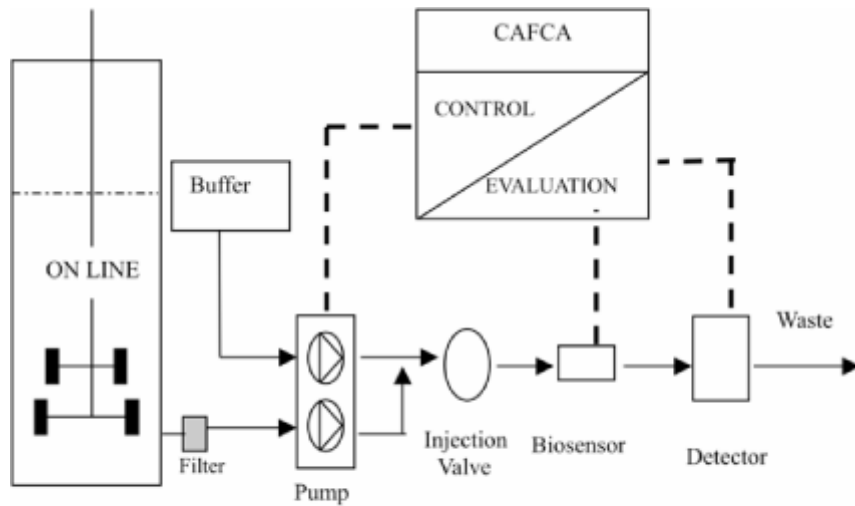

Figure 2: Scheme of biosensor measurements

Influence of Temperature on Biosensor Response

Measurements at different temperatures (21.8, 24.1, 28.2 and 30.9°C) are shown in [Figure 3](#). It can be seen that temperature significantly affects the signal value, imposing a nonlinear behavior, which is stronger at higher temperatures and concentrations. A compensation for these effects is sought. Two alternatives are presented in the sequence.

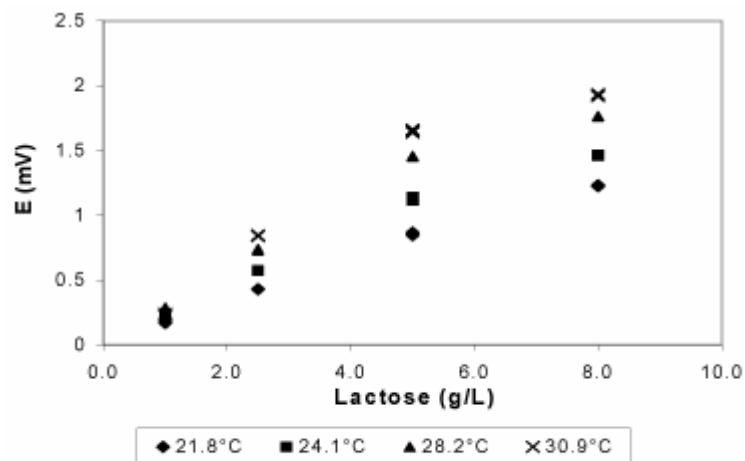

Figure 3: Influence of temperature on lactose biosensor measurements.

(a) Exponential Fitting

Figure 4 shows the results of linear approximation of voltage related to concentration for these temperatures. For each one, two distinct fittings were done. One of them was assumed to have a null constant coefficient.

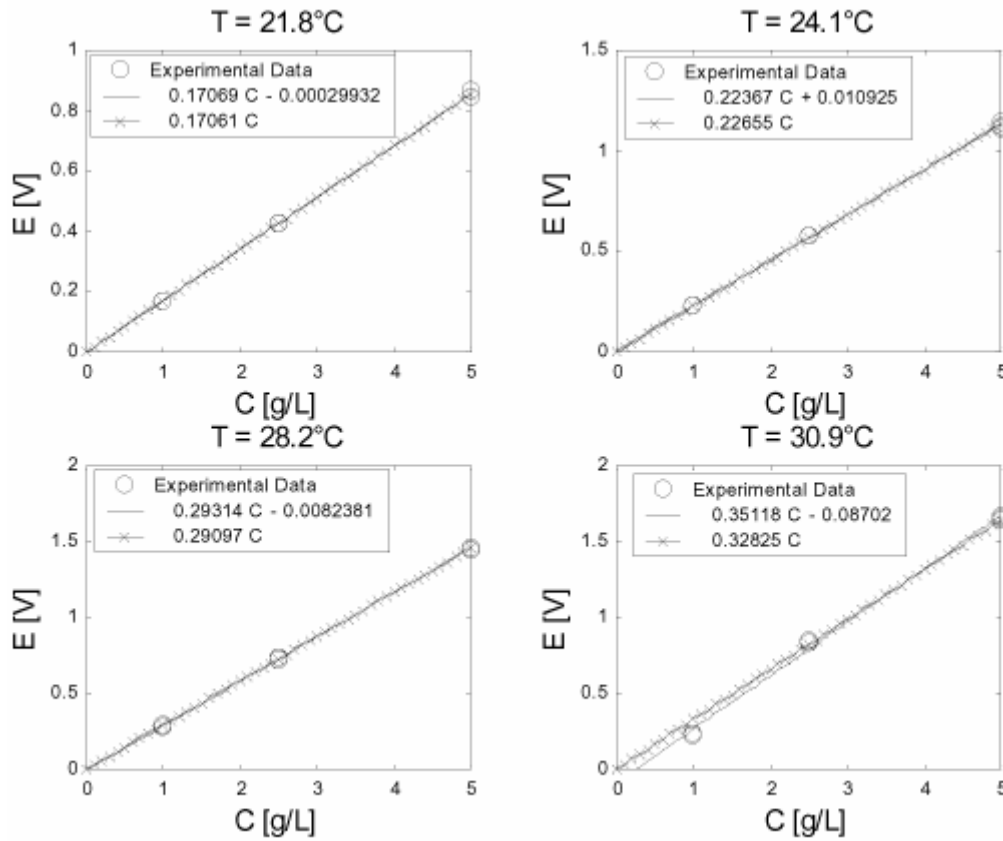

Figure 4: Linear fitting of the biosensor measurements

It can be assumed that the slope related to the null constant coefficient fitting is the most realistic one, since oxygen consumption is not expected in the absence of lactose. The slope at each temperature (alfa) was recorded.

The fitting of alfa to temperature (1/T) was done using the expression below:

$$\ln(\alpha) = A_2/(T+273.15)^2 + A_1/(T+273.15) + A_0 \quad (1)$$

Results are shown in Figure 5. The quadratic dependence on the reciprocal of T (1/T) was accepted as the most correct because of the prediction of a slower enzyme activity (related to the slope of the curve) at higher temperatures. Therefore, the final adjusted expression that relates the signal (in V) to temperature (K) and lactose concentration (g/L) is

$$E[V] = (\exp(-4.399 \times 10^8 (1/T[K])^2 + 2.88 \times 10^5 (1/T[K]) - 4.71 \times 10^2) * C[g/L]) \quad (2)$$

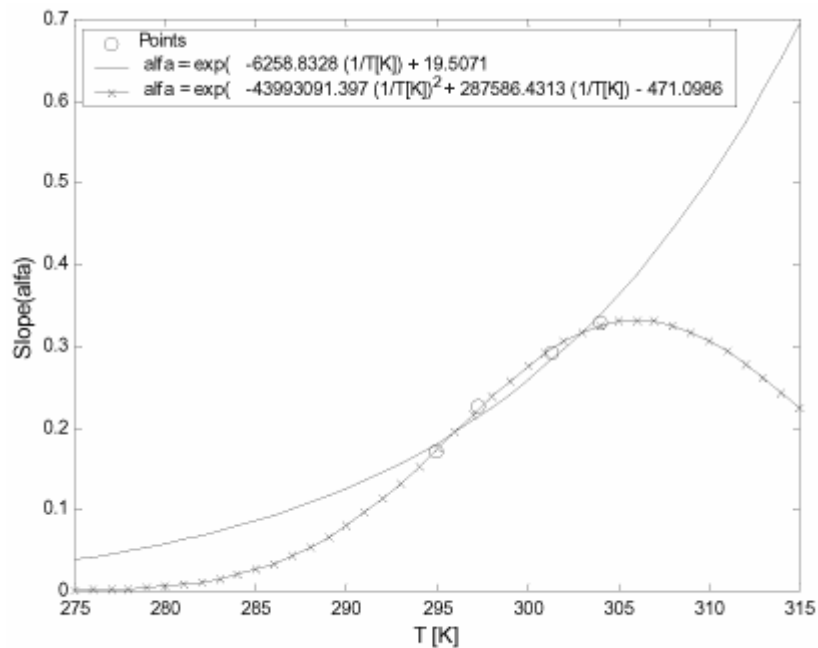

Figure 5: Nonlinear fitting for slope

(b) Neural Network

Neural networks had been used previously to interpret biosensor measurements (Ferreira et al., 2001). However, here the intention is to use them with varying temperature.

Multilayered neural networks were employed. For training, the conjugate gradient method (Leonard and Kramer, 1990) was used. The nets had two neurons in the input layer (temperature and lactose concentration) and one neuron in the output layer (biosensor signal). The best results were obtained for three neurons in the hidden layer.

Eq. (2) was used to calculate the biosensor signal for the exponential fitting. The results of the exponential fitting for a lactose concentration of 8 g/L were outside of the linear range and therefore were not included in the derivation of Eq. (2).

Errors for both fittings were calculated and plotted in [Figures 6](#) and [7](#). It can be seen that the errors and consequently the prediction values of neural networks are better than those for exponential fitting, especially for values outside of the linear range, which can not be considered in the exponential fitting.

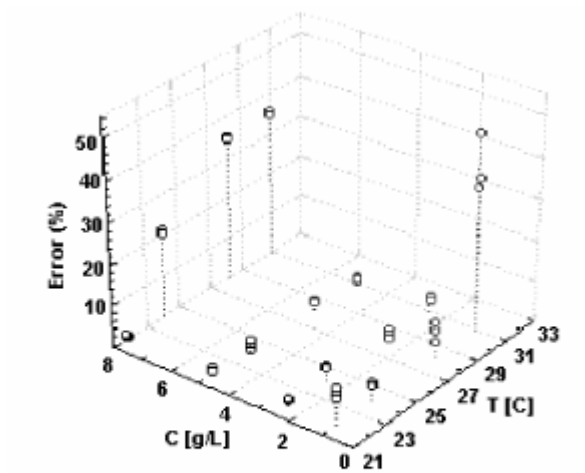

Figure 6: Error for exponential fitting

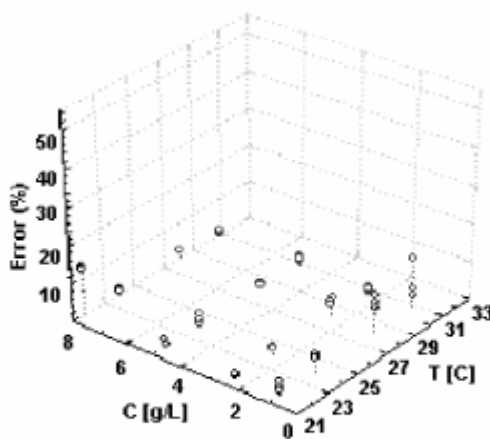

Figure 7: Error for neural network fitting

CONCLUSIONS

A nonlinear behavior was experimentally observed as the temperature and concentration increased. This was due to the fact that the activities of the enzymes were temperature-dependent. Additionally, a saturation phenomenon appears at higher concentrations. In order to deal with this, the FIA system should be operated at constant temperature and restricted sample concentrations. The alternative presented here is to automatically compensate for these effects of temperature, using nonlinear correlations. Neural nets offered the best results.

The functioning of the sensor was stable and it had a short time response, demonstrating that it is an appropriate instrument for applications in the control of the bioprocess described above.

ACKNOWLEDGMENTS

This work was supported by CNPq, FAPERGS and the PROBRAL (CAPES/DAAD) research program.

REFERENCES

- Adányi, N., Szabó, E. E., Váradi, M. (1999). Multi-enzyme Biosensors with Amperometric Detection for Determination of Lactose in Milk and Dairy Products. *Eur. Food Res. Technol.*, 209, 220-226. [[Links](#)]
- Amárita, F., Fernández, C. R., Alkorta, F. (1997). Hybrid Biosensors to Estimate Lactose in Milk. *Analytica Chimica Acta*, 349, 153-158. [[Links](#)]
- Ferreira, L. S., De Souza Jr., M. B., Folly, R. O. M. (2001). Development of an Alcohol Control System Based on Biosensor Measurements Interpreted by Neural Networks. *Sensor and Actuators B*, 75 (3), 166-171. [[Links](#)]
- Folly, R. O. M., Valdman, B., Valero, F., Solá, C. (1996). Potentiometric Sensor for on line Glucose Determination. *Biotechnology Techniques*, 10(11), 867-870. [[Links](#)]
- Holsinger, V. H., Kligerman, A. E. (1991). Applications of Lactase in Dairy Foods and Other Foods Containing Lactose. *Food Technology*, January, 92-95. [[Links](#)]
- Jäger, A., Bilitewski, U. (1994). Screen-printed Enzyme Electrode for the Determination of Lactose. *Analyst*, 119, 1251-1255. [[Links](#)]
- Kullick, T., Beyer, M., Henning, J., Lerch, T., Quack, R., Zeitz, A., Hitzmann, B., Scheper, T., Schürgel, K. (1994). Application of Enzyme Field-effect Transistor Sensor Arrays as Detectors in a Flow-injection System for Simultaneous Monitoring of Medium Components. Part I. Preparation and Calibration. *Analytica Chimica Acta*, 296, 263–269. [[Links](#)]
- Leonard, J., Kramer, M. A. (1990). Improvement of the Backpropagation Algorithm for Training Neural Networks. *Computers Chemical Engineering*, 14 (3), 337-341. [[Links](#)]
- Liu, H., Li, H., Ying, T., Sun, K., Qin, Y., Qi, D. (1998). Amperometric Biosensor Sensitive to Glucose and Lactose Based on Co-immobilization of Ferrocene, Glucose oxidase, β -galactosidase and Mutarotase in β -cyclodextrin Polymer. *Anal. Chim. Acta*, 358, 137-144. [[Links](#)]
- Liu, J., Li, G. (2000). Application of Biosensors for Diagnostic Analysis and Bioprocess Monitoring, *Sensors and Actuators*,. 65, 26-31. [[Links](#)]
- Pasco, N., Jeffries, C. , Davies, Q., Downard, A. J., Roddick-Lanzilotta, A. D., Gorton, L. (1999). Characterisation of a Thermophilic L-glutamate Dehydrogenase

Biosensor for Amperometric Determination of L-glutamate by Flow Injection Analysis, *Biosensors & Bioelectronics*, 14, 171-178. [[Links](#)]

Pfeiffer, D., Ralis, E. V., Makower, A., Scheller, F. W. (1990). Amperometric Bi-enzyme Based Biosensor for the Detection of Lactose – Characterization and Application., *J. Chem. Tech. Biotechnol.*, 49, 255-265. [[Links](#)]

Ponsano, E. H. G., Castro-Gómez, R. J. H. (1995). Fermentação do Soro de Queijo por *Kluyveromyces fragilis* como uma Alternativa Tecnológica para a Redução de sua Capacidade Poluente. *Ciência e Tecnologia de Alimentos*, Campinas, 15, 170-173. [[Links](#)]

Salgado, A. M., Folly, R. O. M., Valdman, B., Valero, F. (1997). Development of a Sucrose Enzymatic Biosensor, *Biotechnology Technique*, 12 (4), 305-307. [[Links](#)]

Scheper, T., Plötz, F., Müller, C., Hitzmann, B. (1994). Sensors as Components of Integrated Analytical Systems. *Trends in Biotechnology*, 12, 42–46. [[Links](#)]

Svitel, J., Curilla, O., Tkáč J. (1998). Microbial Cell-based Biosensor for Sensing Glucose, Sucrose or Lactose. *Biotechnol. Appl. Biochem.*, 27, 153-158. [[Links](#)]

Szczodrak, J. (2000). Hydrolysis of Lactose in Whey Permeate by Immobilized β -galactosidase from *Kluyveromyces fragilis*. *Journal of Molecular Catalysis B: Enzymatic*, 10, 631-637. [[Links](#)]

Vega, F. A.; Núñez, C. G., Weigel, B., Hitzmann, B., Ricci, J. C. D. (1998). On-line Monitoring of Galactoside Conjugates and Glycerol by Flow Injection Analysis. *Analytica Chimica. Acta*, 373, 57 - 62. [[Links](#)]

Watanabe, E., Takagi, M., Takei, S., Hoshi, M., Shu-gui, C. (1991). Development of Biosensors for the Simultaneous Determination of Sucrose and Glucose, Lactose and Glucose, and Starch and Glucose. *Biotechnology and Bioengineering*, 38, 99-103. [[Links](#)]

Address to correspondence

L.S.Ferreira

E-mail: luciane@eng.ufrgs.br

E-mail: luciane@eq.ufrj.br

M.B.Souza Jr

E-mail: mbsj@eq.ufrj.br

J.O.Trierweiler

E-mail: jorge@eng.ufrgs.br

R.O.M.Folly

E-mail: rossana@eq.ufrj.br

B.Hitzmann

E-mail: Hitzmann@Mbox.IFTC.Uni-Hannover.de

Received: March 5, 2002

Accepted: August 30, 2002

All the contents of this journal, except where otherwise noted, is licensed under a
Creative Commons Attribution License

Associação Brasileira de Engenharia Química

Rua Líbero Badaró, 152 , 11. and.

01008-903 São Paulo SP Brazil

Tel.: +55 11 3107-8747

Fax.: +55 11 3104-4649

Fax: +55 11 3104-4649

e-Mail

rgiudici@usp.br