

5th Conference on Production Systems and Logistics

Design and Analysis of Mechanical Gripper Technologies for Handling Mesh Electrodes in Electrolysis Cell Production

Martin Römer¹, Benjamin Winter¹, Edgaras Mazeika¹, Klaus Dröder^{1,2}¹*Institute of Machine Tools and Production Technology, Technische Universität Braunschweig, Braunschweig, Germany*²*Fraunhofer Institute for Surface Engineering and Thin Films IST, Braunschweig, Germany*

Abstract

As climate change accelerates, the demand for green energy is increasing significantly. Due to the intermittent nature of renewable energy, the necessity of long-term storage is growing at the same rate. Hydrogen presents itself as a promising option for long-term storage, the demand for electrolysis plants is therefore increasing significantly. Solutions for scaling up alkaline electrolysis production are currently lacking, particularly in the handling of the conventionally used large mesh electrodes. Therefore, new gripping concepts and technologies have to be developed to enable precise and automated handling of these electrodes, as established handling methods have failed due to the porous, limp and weak magnetic material properties. The present research therefore demonstrates two new ingressive gripping systems in the form of individual gripping elements, which can be combined to form a gripper. The technologies identified here are based on threaded or spiral-like structures. Depending on the handled mesh geometry, the gripper elements are designed accordingly. In order to grip the wire mesh, the gripping element is moved translationally and rotationally synchronized. As a validation, sample gripper elements were tested for a range of mesh geometries. The individual gripper elements were produced using the Selective Laser Melting process (SLM), as the fine structures would be exceedingly challenging as well as very costly to produce using conventional manufacturing methods. The gripper elements were tested for three aspects of the handling process: Reliability, retention force and precision. The results exhibit a high holding force for fine meshes with the spiral structures, while the results with the examined screw structures demonstrate the possibility for a very high positioning accuracy. Consequently, potential use cases can be derived for both structures for the handling of mesh electrodes enabling new possibilities for the automated assembly of wire meshes for electrolysis cell production.

Keywords

Electrolysis cell production; Handling; Meshes; Selective Laser Melting; Robotics

1. Introduction

To meet the growing demand for hydrogen in Germany, estimated for 2023 at 90-110 TWh, the installed electrolysis capacity has to be increased significantly [1]. Since alkaline electrolysis (AEL) is considered the most developed technology to meet this demand, the production capacity of AEL manufacturing must be substantially expanded [2]. The most promising increase in production capacity is expected from an automation of the currently predominantly manual assembly of AEL cells. A major challenge for the automation of these processes is the lack of handling and gripping technologies for AEL electrodes, which consist of regular nickel-based mesh structures in order to provide a large surface area. A wire mesh is often used for the electrodes [3–6], consisting of regularly woven metal wire, usually in plain weave. They can be

described geometrically by the mesh size w_m and the wire diameter d_m (Figure 1). Accordingly, the mesh height is twice the wire diameter $2 d_m$ [7].

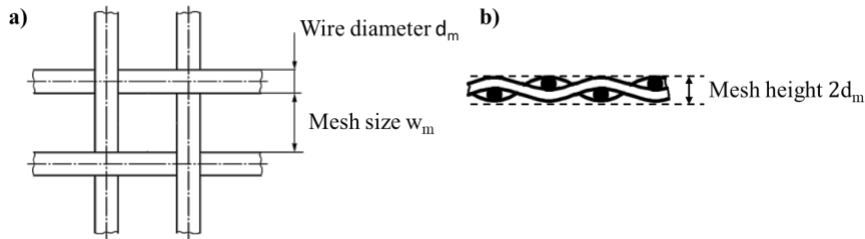

Figure 1: Structure of wire meshes according to DIN ISO 9044 in top view (a) and side view (b) [7]

The high permeability of the mesh structure restricts an implementation of vacuum and Bernoulli grippers. Conventional mechanical handling systems such as yaw grippers are also not feasible in the majority of cases, as it is only possible to grip the edges of the mesh, which would lead to fraying of the wires at the edges and negatively affect the assembly process. The utilization of magnetic grippers is complicated by the almost tenfold lower relative magnetic permeability of nickel compared to steel (material weakening) and by the geometrically low mass filling degree in the magnetic field (geometric weakening) [8]. Therefore, almost the entire surface of the wire mesh would have to be covered with magnetic grippers, making this solution economically unattractive. Currently, there are very few studies on automated wire mesh handling, therefore solutions for the handling of similar structures is briefly discussed. The handling of porous and permeable materials with limited leakage, such as textiles, is often attempted with classical vacuum handling by increasing the suction volume flow, e.g. with Coanda ejectors [9]. Larger wire meshes, such as those used to reinforce concrete structures, can be handled with simple yaw grippers due to large wire diameters of several millimetres and large mesh size. However, as the components of the AEL cells are fine wire meshes (i.e. mesh size and wire diameter ≈ 0.5 mm), these solutions are not suitable for this case. One possibility is to use ingressive grippers, which create a holding force through a penetration of the component. This principle is used, for example, in the handling of organic sheets or textiles with needle grippers [10,11]. The use of conventional needle grippers has already been tested in preliminary trials. However, the penetration of various needle sizes caused unacceptable damage to wire meshes of various mesh sizes in the form of elongation and displacement, affecting the deposition accuracies as well as overall geometry tolerances. Thus, new gripper technologies have to be developed. The concept of an ingressive spiral gripper has been shown by Tilli et al. [12] as a possible solution for handling heavy, deformable components. This concept is transferred for the handling of lighter but also flexible wire meshes in the following chapters. For this, the development of innovative approaches is discussed in this study with the following goals:

- Design and development of ingressive grippers for the handling of fine wire meshes
- Prototypical manufacturing and testing of various dimensions and designs of the gripper
- Experimental analysis of reliability, retention force and handling accuracy

2. Materials and Methods

2.1 Design of the gripper elements

In the following, two new gripping principles for the handling of electrode meshes are presented. The principle of the two gripper designs is based on rotating a helix-shaped structure into a single mesh opening create a force and form fit. The first structure investigated in the present study is designed as the simplest form of this principle, a spiral. The second structure is a screw-like design, reinforcing the stability of the spiral with a central axis. For larger electrode meshes in the range up to 14 m^2 , which are common for AEL

[13], the gripping system must consist of a larger number of these elements in order to enable a stable handling during the entire assembly process.

2.1.1 Spiral gripper concept

In order for the spiral to fit through the mesh and develop a reliable retention force without damaging it, its geometry must be matched to the wire mesh. Therefore, a specific gripper geometry has to be developed for each mesh. To describe the geometry of the spiral the diameter d_{sp} , the outer diameter D_a , and the pitch P_{sp} have to be determined. The spirals diameter d_{sp} should be selected as large as possible to achieve the highest possible rigidity, especially for fine wire meshes. However, too large diameters will make impede the penetrability of the mesh. Therefore, the mesh size itself is the boundary condition for the spiral diameter d_{sp} . Therefore for the following calculations, a limit of $d_{sp} \leq 0.75 w_m$ has been set. Furthermore, the outer diameter D_a of the spiral must cover the diagonal of a mesh (Figure 2a).

$$D_a \geq \sqrt{2}(w_m + d_m) \quad (1)$$

To simplify the pitch calculation, the mesh wires between two crossing points are assumed to be straight and resemble an oval rod with aspects d_m and $2 d_m$ (Figure 2b). Therefore, the outer diameter of the spiral must cover the diagonal of a mesh (Figure 2).

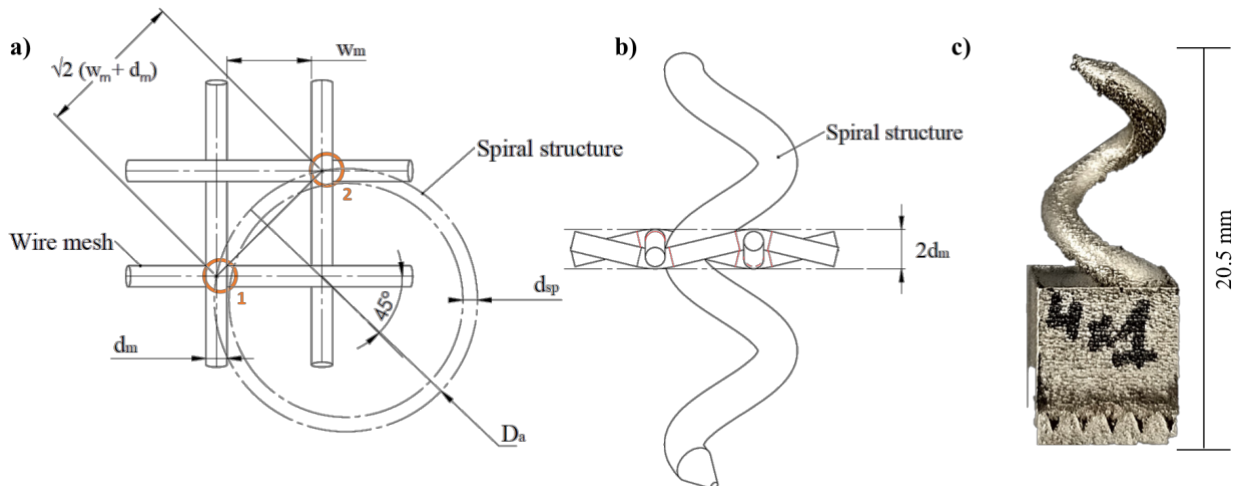

Figure 2: Contact points of the spiral structure with the mesh (a) and side view of spiral structure passing the mesh (b); gripping element produced with SLM (c)

Within the distance of the two points drawn (1 to 2), the pitch must be at least large enough to bridge the path of the mesh height $2 d_m$ and the spiral diameter d_{sp} . Depending on the selected outer radius, the following formula applies:

$$P_{sp} \geq \frac{\pi}{\arcsin\left(\frac{\sqrt{2}(w_m + d_m)}{D_a}\right)} \cdot (2d_m + d_{sp}) \quad (2)$$

2.1.2 Screw gripper concept

As an enhancement of the spiral to increase stiffness, a central axis was added to create a screw like structure which is based on the design of auger core drills [14]. When the gripper element is rotated into the wire mesh, the axis of rotation must be eccentric to the centre of the single mesh, resulting in three points of contact with the mesh (Figure 3a). Two lateral contact points (1, 2) define the position of the screw to the

mesh. The third contact point below the mesh wire (3) creates the form fit and is critical to the gripper element load carrying capacity. To achieve the three contact points, the screw geometry must be matched to the mesh geometry in terms of axis diameter d_s , the bar height h_s and the screw pitch P_s .

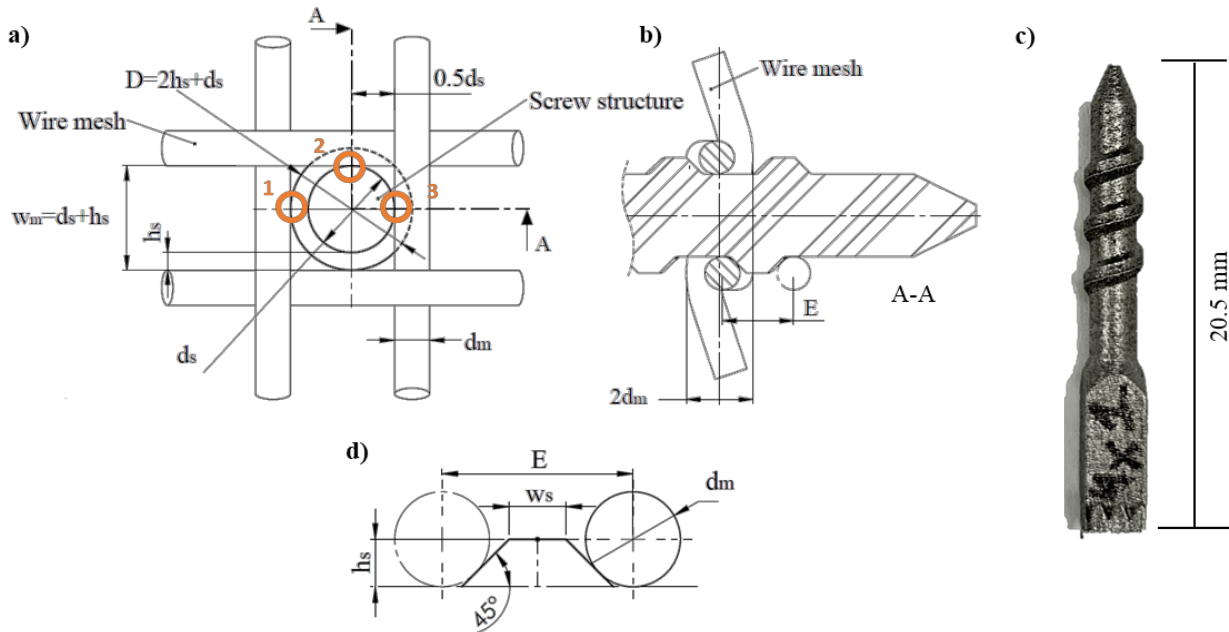

Figure 3: Geometric illustration of the screw gripper element in top view (a), and side view (b); gripping element produced with SLM (c), close-up to screw rod (d)

In order to pass the mesh, the axis diameter d_s and the bar height h_s must not be greater than the mesh size. To maximize the strength of the gripping element, the axis diameter must be as large as possible, but the bar height must be sufficient to provide a good contact surface so that the mesh does not slip under load. In this case, a bar height of at least half the wire diameter is recommended.

$$d_s = w_m - h_s \quad \text{with} \quad h_s \leq 0.5 d_m \quad (3)$$

To reach the required contact points and be able to grip the wire mesh, the screw must reach the mesh height of $2 d_m$ within three quarters turn (Figure 3a contact points 2 and 3) and bridging the height of the screw rod E (Figure 3c). Therefore, the pitch is calculated as follows:

$$P_s \geq \frac{4}{3} [2h_s + w_s + d_m(1 + \sqrt{2})] = \frac{4}{3} E \quad (4)$$

The variable w_s describes the thickness of the bar. While it is freely selectable, it must be considered in relation to the achievable precision of the manufacturing process. For the manufacturing of the gripper element specimens, w_s was selected as 1.0 mm. At the minimum allowable pitch, the mesh is additionally clamped between two screw flanks. However, the increased stability of the gripping leads to a smaller tolerance window in the gripping process and thus lowers gripping reliability.

2.2 Gripper geometry manufacturing

Due to the geometrical freedom and the manufacturability of delicate structures, the gripper elements were generated using the SLM process. Compared to other additive processes for metals, this process enables a high mechanical strength with a material density of almost 100% [15]. A SLM125 from SLM Solutions Group AG is used for manufacturing the grippers, which are generated using the martensitic stainless steel 15-5PH with a powder grain size of 15 – 45 μm with the process parameters shown in Table 1.

Table 1: Process parameters used to generate the gripper geometries

Laser power	Laser focus	Scanning speed	Layer thickness	Hatching distance
248 W	66.4 μm	840 mm/s	50 μm	120 μm

2.3 Analysis of handling properties

To determine the suitability of the gripping principles on mesh components, three aspects of the gripping process - reliability, retention force and handling accuracy - are evaluated. The grippers are investigated on a set of nine wire meshes with various mesh sizes and wire diameters (see Appendix 1). As described in the previous sections, the gripper geometry has to be developed specifically for each wire mesh. Two gripping elements are used for the test, since the use of a single gripping element can lead to unwanted rotation of the mesh sample. These gripper elements are clamped in a gripping jig, which is mounted on a KUKA KR6 industrial robot with a repeatability of ± 0.05 mm. To pick up the wire mesh, the gripper elements are synchronously inserted into the mesh. For the gripping process the gripper elements are rotated by 360° , in order to enable a reliable releasing process, the elements are rotated backwards by 380° for releasing the meshes. The rotation speed of the gripping element was set to $60^\circ/\text{s}$. The feed rate is set according to the respective thread pitch. Tilting can be assumed to be negligible due to the three contact points per element.

The reliability is tested by successfully gripping, holding and releasing. A total of ten repeated handling operations are carried out for each tested wire mesh. For this experiment, the wire mesh is gripped from a flat surface and held at a defined height of 100 mm for 10 s before releasing it on that surface again. Reliability is determined for each of the three steps separately. Gripper elements whose reliability in any of the operations is less than 50%, or which are damaged during the test, are not included in the retention force and handling accuracy analysis. To determine the maximum retention force of the gripper element, a common scenario is used, where a robot is used to pull vertically on a clamped component, while measuring the force the applied force [16,17]. The force is measured with a K6D40 200 N load cell from ME Messsysteme GmbH, which is mounted between the robot and the gripping device. This experiment is repeated five times with a pull-off-speed of 1.2 mm/s and stopped at a maximum force of 50 N to avoid damaging the wire mesh or gripper elements. The obtained value therefore represents the retention force of two gripper elements.

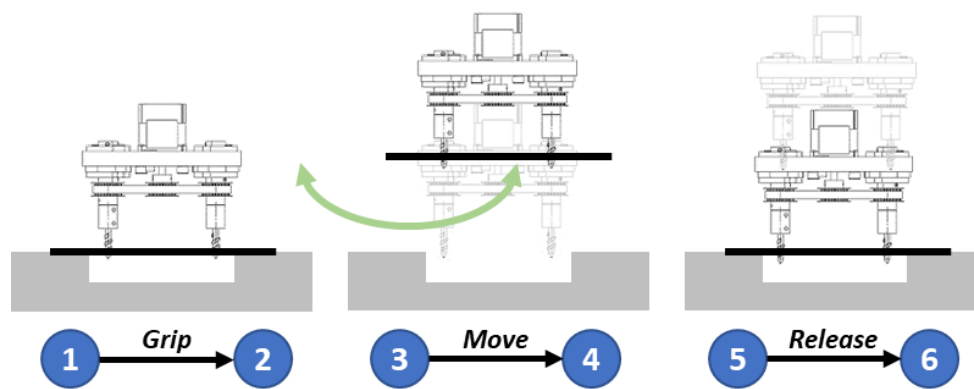

Figure 4: Illustration of the six measurement points implemented during experiments for the determination of the handling accuracy

The achievable precision is determined in a three-step process of *gripping*, *moving* and *releasing* (Figure 4). The displacement of the wire mesh after each of the three steps is calculated by comparing the position before and after the respective action. A 20 MP camera is used to measure the positions. The wire mesh is placed on a flat surface. Firstly, the gripping accuracy is measured by comparing the start position and the position after gripping (1 to 2) and calculating the displacement in X, Y and rotation around the Z-axis (RZ).

Secondly the wire mesh is lifted and a lateral handling trajectory is performed with a distance of ≈ 1 m each way on a section of a circular path (radius ≈ 580 mm) at a maximum speed of 2.5 m/s and maximum acceleration of the robot to simulate the effects of lateral process forces. The move accuracy is then calculated by comparing the wire mesh position before and after the simulated trajectory (3 to 4). Finally, the release accuracy is again calculated from the displacement before and after the mesh is released back onto the surface (5 to 6). Additionally, the total displacement of the wire mesh after the handling operation is determined by the difference between the positions of (1) and (6).

2.4 Determination of the manufacturing-related reproducibility

The gripper elements described are manufactured in various dimensions down to a minimum cross-section of 0.31 mm. Due to the high thermal loads during processing, thermal distortion and inhomogeneity can occur in the component, which can increase the risk of gripper elements breaking. This raises the question of the manufacturing-related influences on the geometries and the mechanical properties. This issue is investigated using tensile tests and CT scans. The tensile tests are carried out according to DIN EN ISO 6892-1:2019 [18], using non-standardized specimens. The gripper elements are extended by two clamping bases on each side for clamping in a Zwick Roell Z50 testing machine. A strain controlled test speed of 0.00025 1/s is used. The aim is to measure the forces in order to derive a statement about the maximum possible retention force of each gripper element. In addition, the geometric dimensional accuracy and reproducibility of the CT scan are also investigated. For reconstruction and measurement, the geometries were scanned using the FF35 CT from Comet Yxlon GmbH.

3. Results

3.1 Handling properties

All gripper elements studied achieved 100% reliability during holding; therefore these values are not discussed further. For wire meshes with a wire diameter equal and above 2 mm, the spiral gripper elements achieve 100% reliability during gripping and, with one exception, also during release (see Figure 5). For finer meshes, reliability depends on the ratio of mesh size and wire diameter. Wire meshes with larger diameters and the same mesh size (therefore higher rigidity) lead to a reduction in reliability and an increased risk of damage to the gripper elements. This is observable with the combination 1 x 0.28 / 1 x 0.63 mm and the 0.5 x 0.14 / 0.5 x 0.32 mm combinations. Therefore, for fine mesh structures with larger wire diameter the gripper is not suitable in its current design. Also the reliability for gripping is slightly higher than for releasing.

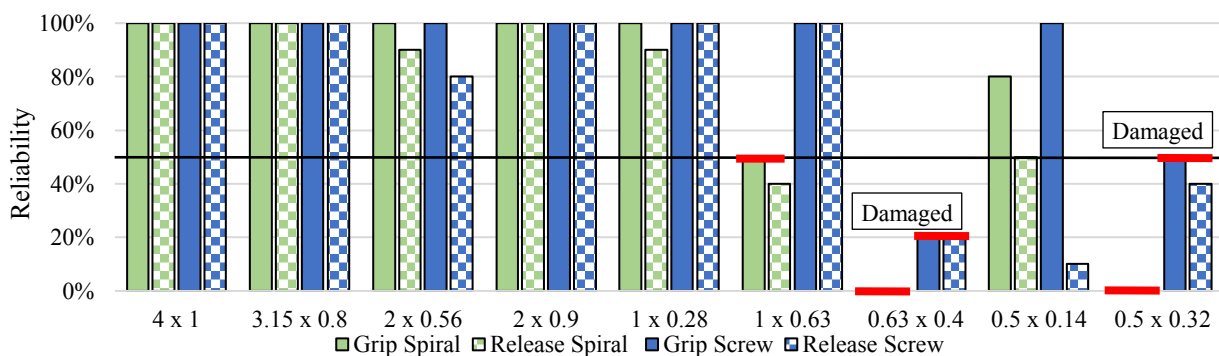

Figure 5: Reliability of the spiral gripper with different wire mesh geometries with sample size ten, experiments resulting in damage to the gripper are highlighted in red

The screw gripper achieved a consistent high reliability even for finer meshes. A difference in gripping and releasing similar to the spiral gripper does not occur. A clear exception is the 0.5 x 0.14 mm wire mesh. It is assumed, that the rough surface of the fine screw resulting from the manufacturing process negatively

impacts the releasing process. This surface roughness can also be detected on the CT scans. Particularly in the case of smaller screw geometries with a core diameter of less than 0.75 mm, rough and partially undefined screw flanks can be detected (see Appendix 2). Due to the damage to the gripper during reliability tests, the gripper elements of spiral and screw concept were excluded for the 0.63 x 0.4 mm and 0.5 x 0.32 mm wire meshes and the spiral gripping element for 1 x 0.63 mm wire mesh for the retention test. For the spiral gripper, with the exception of the 4 x 1 mm wire mesh, a decreasing retention force can be observed as the mesh size decreases. Under load, the finer spirals stretch earlier and allow the wire mesh to slip accordingly. The values for the screw geometry do not show a regular progression. In comparison, the spiral geometry achieves a higher force than the screw geometry, with the exception of the 2 x 0.9 mm wire mesh (Figure 6). The reason for the higher retention force, especially in fine structures, is considered to be the improved form fit of the spiral geometry. On the one hand, the bearing surface of the spiral is higher than the screw, even for finer structures. On the other hand, the screw structures in the range of core diameters smaller than 0.75 mm have an undefined structure due to the manufacturing process, which hinders a form fit (see Appendix 2).

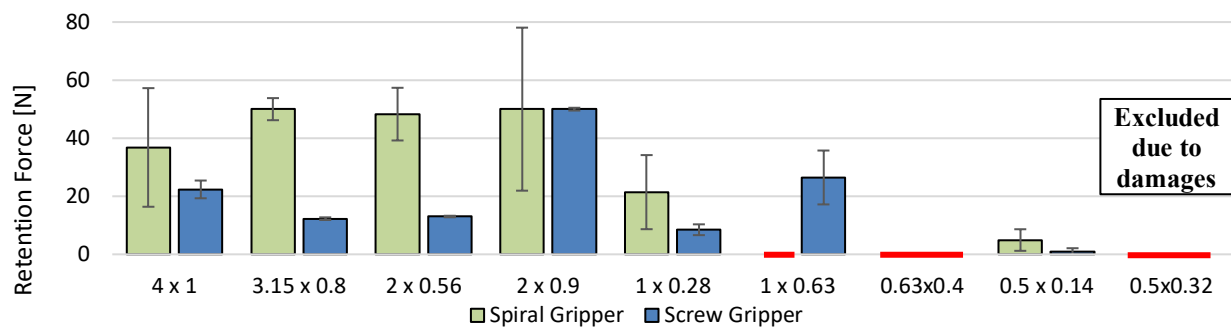

Figure 6: Average retention forces of spiral and screw gripper on wire mesh geometries with a sample size of five

A major disadvantage of the spiral geometry can be seen by comparing the component displacement during the handling. Comparing the precision results of the two gripping elements, the spiral element shows both a higher average deviation and an increased scattering of the position deviations. An exception is the wire mesh 2 x 0.9 (Figure 7). This may be due to the more favourable position of the contact points and the central axis of the screw, which, unlike the spiral geometry, stabilize the wire mesh. Although the displacements during the gripping and releasing process are comparably high with the geometry of the screw, but the total displacement remains small. This results in a reversible displacement of the component. This effect is not observed with the spiral geometry. The screw geometry can therefore be described as more precise in comparison. The individual values of all precision tests are given in Appendix 3.

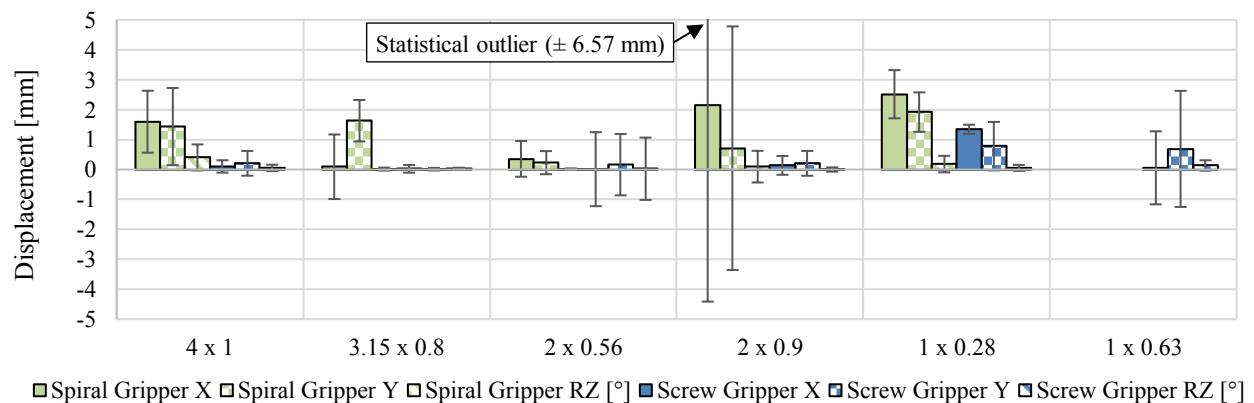

Figure 7: Average overall displacement of wire meshes handled with spiral and screw gripper with sample size 10 subdivided into X, Y and RZ

3.2 Geometrical and mechanical properties of the gripper geometries

The correlation of the wire meshes and the gripper geometries with the mean values of the maximum retention force is shown in Figure 8. While the spirals are under torsion, bending and tensile stress, the screws are only loaded by tensile stress. As a result, the spirals generally achieve lower maximum retention forces across all the wire meshes studied. In comparison, a larger number of spiral grippers must be used to handle a wire mesh than screw grippers. Furthermore, compared to the spiral geometries, the calculated standard deviations indicate a higher reproducibility of the screw geometries. As the core diameters of the screw geometries become smaller, the standard deviations of the maximum holding force increase, indicating less reproducibility of the geometries through the manufacturing process. The CT scans supports this assumption. Various defects are visible as interconnected material dots and inaccurate screw geometries for these sizes. For core diameters of 0.75 mm and above, accurately defined screw geometries are possible, which also reflect the higher handling properties in the experiments. The spiral grippers showed significant thermal distortion in the smallest dimension with a core diameter of 0.31 mm. This specimen geometry consequently deviated strongly from its nominal geometry and could not be tested more accurately due to instability. Therefore, no values are given for a 0.5 x 0.32 mm wire mesh. The spiral gripper for 0.63 x 0.4 mm wire mesh failed to record data as the structures broke immediately when clamped. This supports the theory spiral grippers are not suitable for smaller wire meshes.

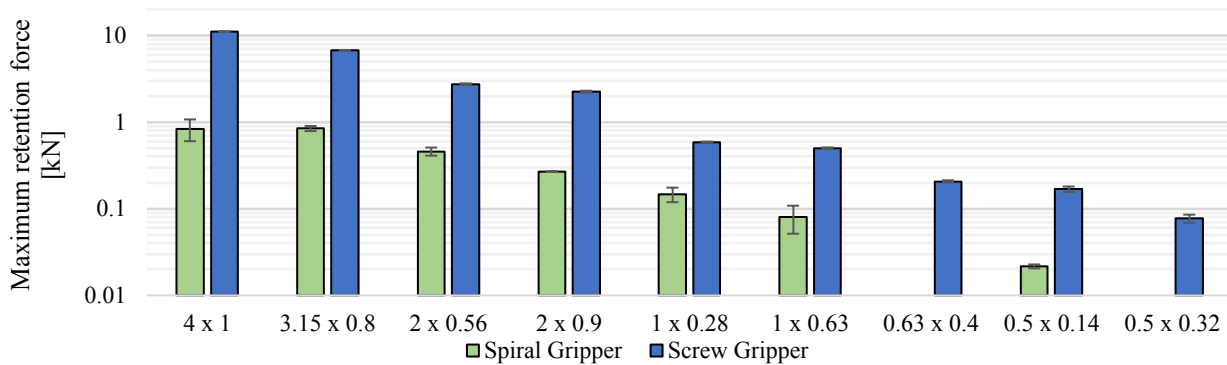

Figure 8: Mean values of maximum retention force of investigated spiral and screw gripper geometries

4. Conclusion and Outlook

A major challenge in the automation of alkaline electrolysis cell production is the handling of mesh electrodes. Due to the failure of established gripping technologies, the objective of this research was to develop and verify concepts for the safe and precise handling of these components. For this purpose, the two concepts of spiral and screw grippers were presented as well as the design guidelines in order to match them to individual wire mesh geometries. In order to verify the concepts, gripper elements for nine different mesh specimens were manufactured using the SLM process and tested for reliability, retention force and handling accuracy. The screw geometry demonstrated a comparably higher overall reliability. Both concepts showed weaknesses up to a damaging of the gripper with very fine meshes and correspondingly very filigree gripper elements. In terms of retention force, the spiral geometry achieved a consistently higher value in comparison. Inaccuracies at the transition from the centre axis to the mesh resulted in a reduced contact surface for the screw gripper and thus to an increased slip of the mesh under load, especially with fine mesh structures. In contrast, the central axis and the three contact points with the mesh created a stable contact with the mesh, which led to a high overall handling accuracy. Based on the geometry and material studies, it was possible to identify the manufacturing constraints in terms of dimensioning in the Selective Laser Melting process. In summary, the screw geometry has great potential for use in handling mesh electrodes, as it combines a high reliability and handling accuracy with a reliable and widespread manufacturing process. With the basis created with this research, a selection and assessment of screw and spiral grippers for implementations with

various wire meshes is possible. This establishes these gripping principles as a possible future solution for the damage-free, precise and automated handling of metal grids, therefore increasing the viability and efficiency of an automated production of electrolysis cells.

Acknowledgements

The authors gratefully acknowledge the financial support by the German Federal Ministry of Education and Research (BMBF) via grant number 03HY119D (project acronym: 'INSTALL AWE - H2NRY').

Appendix 1: Geometric dimensions of the mesh samples used

No.	Mesh size w_m [mm]	Wire diameter d_m [mm]
1	4	1
2	3.15	0.8
3	2	0.56
4	2	0.9
5	1	0.28
6	1	0.63
7	0.63	0.4
8	0.5	0.14
9	0.5	0.32

Appendix 2: CT scan of screw grippers with core diameters of a) 0.31 mm b) 0.75 mm c) 1.60 mm and of spiral grippers with core diameters of d) 0.31 mm e) 0.35 mm and f) 1.25 mm

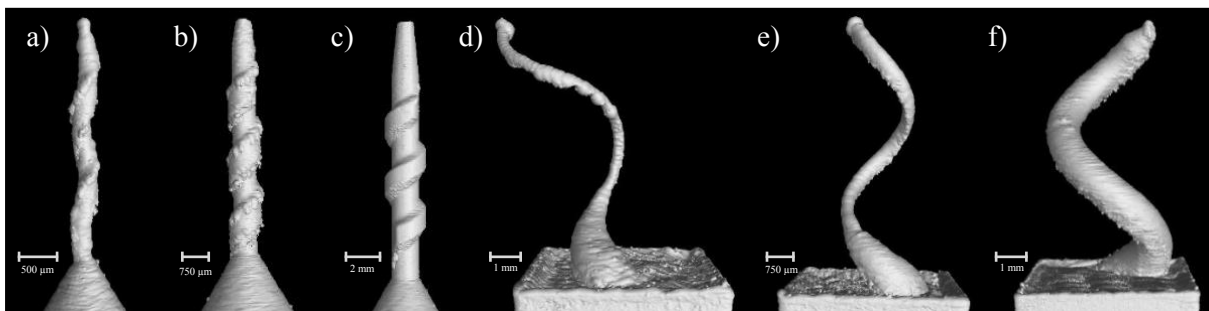

Appendix 3: Average measured values of the displacement of the different meshes in the precision test according to sub-processes

Gripper	Wire Mesh (mesh size x wire diameter) [mm x mm]	(1-2) Grip- Displacement RZ [°]	(1-2) Grip- Displacement X [mm]	(1-2) Grip- Displacement Y [mm]	(3-4) Move- Displacement RZ [°]	(3-4) Move- Displacement X [°]	(3-4) Move- Displacement Y [°]
Screw	4 x 1	-0.414	0.138	1.344	0.168	0.115	-0.258
Screw	3.15 x 0.8	-0.027	0.597	1.998	0.029	1.116	0.773
Screw	2 x 0.56	-0.297	-0.367	0.735	0.000	0.210	0.124
Screw	2 x 0.9	-0.038	0.344	0.402	-0.013	0.067	0.048
Screw	1 x 0.63	-0.038	-0.287	1.539	-0.001	-0.010	-0.115
Screw	1 x 0.28	-0.067	0.000	-0.471	0.476	0.878	-0.353
Spiral	4 x 1	0.261	-0.884	0.999	0.126	-0.668	-0.143
Spiral	3.15 x 0.8	-0.026	-1.206	0.241	0.015	1.269	0.468
Spiral	2 x 0.56	0.012	-1.252	-0.299	-0.037	1.737	0.124
Spiral	2 x 0.9	0.755	-4.191	-0.402	-0.145	2.281	0.811
Spiral	1 x 0.28	0.141	-0.517	0.103	0.343	0.019	-0.363

Gripper	Wire Mesh (mesh size x wire diameter) [mm x mm]	(5-6) Release- Displacement RZ [°]	(5-6) Release- Displacement X [mm]	(5-6) Release- Displacement Y [mm]	(1-6) Overall Displacement RZ [°]	(1-6) Overall Displacement X [mm]	(1-6) Overall Displacement Y [mm]
Screw	4 x 1	0.411	-0.276	-1.504	0.054	-0.103	-0.207
Screw	3.15 x 0.8	0.013	-1.194	-1.895	-0.027	-0.023	0.011
Screw	2 x 0.56	0.373	0.310	-0.896	0.025	-0.011	-0.161
Screw	2 x 0.9	-0.014	-0.379	0.023	0.000	-0.138	0.207
Screw	1 x 0.63	0.036	-0.769	-0.448	-0.054	-1.344	0.781
Screw	1 x 0.28	0.010	-0.402	1.137	-0.135	0.057	0.689
Spiral	4 x 1	-0.029	0.448	0.138	0.403	-1.596	1.435
Spiral	3.15 x 0.8	0.027	-0.494	1.596	0.014	-0.092	1.631
Spiral	2 x 0.56	0.062	-0.080	-0.896	0.012	-0.356	-0.230
Spiral	2 x 0.9	-0.853	3.169	-0.115	-0.096	2.159	0.712
Spiral	1 x 0.28	-0.061	2.825	1.091	-0.181	2.515	1.918

References

- [1] Stiftung Arbeit und Umwelt der IG BCE, 2021. Wasserstoffbasierte Industrie in Deutschland und Europa., Berlin.
- [2] Smolinka, T., Wiebe, N., Sterchele, P., Palzer, A., Lehner, F., Jansen, M., Steffen Kiemel, Robert Mieke, Sylvia Wahren, Fabian Zimmermann, 2018. Studie IndWEde Industrialisierung der Wasserelektrolyse in -Deutschland: -Chancen und Herausforderungen für nachhaltigen Wasserstoff für Verkehr, Strom und -Wärme, Berlin.
- [3] Gannon, W.J.F., Warwick, M.E.A., Dunnill, C.W., 2020. Woven Stainless-Steel Mesh as a Gas Separation Membrane for Alkaline Water-Splitting Electrolysis. Membranes 10 (5).
- [4] Hu, X., Tian, X., Lin, Y.-W., Wang, Z., 2019. Nickel foam and stainless steel mesh as electrocatalysts for hydrogen evolution reaction, oxygen evolution reaction and overall water splitting in alkaline media. RSC advances 9 (54), 31563–31571.

- [5] Phillips, R., Edwards, A., Rome, B., Jones, D.R., Dunnill, C.W., 2017. Minimising the ohmic resistance of an alkaline electrolysis cell through effective cell design. *International Journal of Hydrogen Energy* 42 (38), 23986–23994.
- [6] Schalenbach, M., Kasian, O., Mayrhofer, K.J., 2018. An alkaline water electrolyzer with nickel electrodes enables efficient high current density operation. *International Journal of Hydrogen Energy* 43 (27), 1–7.
- [7] Deutsches Institut für Normung e. V. Industriedrahtgewebe – Technische Anforderungen und Prüfung. Beuth Verlag, Berlin.
- [8] Edwards, T.C., Edwards, T.C., Steer, M.B., Steer, M.B., 2016. *Foundations for microstrip circuit design*, Fourth edition ed. Wiley IEEE Press, Chichester, West Sussex.
- [9] Natarajan, E., Onubogu, N.O., 2011. Application of Coanda Effect in Robots – A Review. *International Conference on Mechanical Engineering and Technology*, London 2011.
- [10] Bruns, C., Bohne, F., Mücke-Camuz, M., Behrens, B.-A., Raatz, A., 2019. Heated gripper concept to optimize heat transfer of fiber-reinforced-thermoplastics in automated thermoforming processes. *Procedia CIRP* 79, 331–336.
- [11] Ebraheem, Y., Drean, E., Adolphe, D.C., 2021. Universal gripper for fabrics – design, validation and integration. *International Journal of Clothing Science and Technology* 2019 (33), 643–663.
- [12] Tilli, J., Brando, A., Fantoni, G., 2014. Gripping Device for Heavy and Deformable Materials Handling: Concept, Design, Selection and Test. *Procedia CIRP* 21, 373–378.
- [13] Prout, N.M., 1990. *Modern Chlor-Alkali Technology : Volume 4*. Elsevier Applied Science, London.
- [14] Hong, J., Talalay, P., Sysoev, M., Fan, X., 2014. DEM modeling of ice cuttings transportation by electromechanical auger core drills. *Ann. Glaciol.* 55 (68), 65–71.
- [15] Armstrong, M., Mehrabi, H., Naveed, N., 2022. An overview of modern metal additive manufacturing technology. *Journal of Manufacturing Processes* 84, 1001–1029.
- [16] Gabriel, F., 2022. *Methodenentwicklung zur Energieeffizienzsteigerung in der vakuumbasierten Handhabung*. Dissertation, Braunschweig.
- [17] Straßer, G., 2011. *Greiftechnologie für die automatisierte Handhabung von technischen Textilien in der Faserverbundfertigung*. Dissertation. Utz, München.

Biography

Martin Römer (*1991) is a research associate at the Institute of Machine Tools and Production Technology (IWF) at TU Braunschweig in the field of handling and automation. He is currently working on automated assembly technologies for electrolysis cell assembly. He studied mechanical engineering at the TU Braunschweig, specialising in production and systems engineering.

Benjamin Winter (*1993) is a research associate at the Institute of Machine Tools and Production Technology (IWF) at TU Braunschweig in the field of tool development and additive manufacturing. He is currently working on the implementation of additively manufactured components in primary and forming tools. He studied mechanical engineering at the TU Braunschweig

Edgaras Mazeika (*1997) studied mechanical engineering at the TU Braunschweig. In his final thesis, he worked on the verification of the suitability of grippers for wire mesh.

Klaus Dröder (*1968) is the head of the Institute of Machine Tools and Production Technology (IWF) at TU Braunschweig. Prof. Dr.-Ing. Klaus Dröder is a member of the German Academic Association for Production Technology (WGP) as well as the International Academy for Production Engineering (CIRP). In addition to his activities as professor and institute director, he is also a member of the board of the Automotive Research Centre Niedersachsen (NFF) and the Open Hybrid Lab Factory (OHLF).