

2017 INTERNATIONAL AIRCRAFT CABIN AIR CONFERENCE



CONFERENCE PROCEEDINGS

Sessions presented at the
2017 International Aircraft Cabin Air Conference

19-20 September 2017
Imperial College London



Index

Overview	S03
‘Fragmentation of Information’ in International Data Gathering from Aircraft Fume Events	S04
Arie Adriaensen	
Aerotoxic Syndrome: A New Occupational Disease?	S12
Jonathan Burdon, Susan Michaelis, C. Vyvyan Howard	
Aircraft Cabin Air Supply and the Internal Air System	S17
Peter RN Childs	
Aircraft Operator Safety Case for Managing Fume Risk	S22
Cliff Edwards	
Have You Been Exposed to Aircraft Engine Oil? Candidate Biomarkers of Exposure	S26
Clement E. Furlong, Judit Marsillach, Michael J. MacCoss, Rebecca J. Richter, Thomas R. Bukowski, Andrew N. Hoofnagle, Matthew G. McDonald, Allan E. Rettie	
Association and Causation: Bradford Hill Approach to Aerotoxic Syndrome	S32
David Gee	
Progress Report: Diagnostics of Health Disorders and Bio Monitoring in Aircraft Crew Members after “Fume Events” – Preliminary Results After Analyzing Patient Files	S38
Astrid Rita Regina Heutelbeck	
Pathogenesis of Non-Specific Neurological Signs and Symptoms in Aircrew on Civil Aircraft	S43
C. Vyvyan Howard	
Lubricant and Lubricant Additive Degradation: Implications for Cabin Air Quality	S45
David W. Johnson	
Airline Captain’s Case Study of Jet-Engine Oil Based Contaminated Cabin Air	S52
Michael Kramer	
Origins of Contaminated Air	S55
Tristan Loraine	
Air Accident Investigation Findings and Recommendations: Aircraft Contaminated Air Events	S59
Tristan Loraine	
Case study: BA 286 & BA 12	S64
Susan Michaelis	
EASA and FAA Research Findings and Actions – Cabin Air Quality	S69
Susan Michaelis	
Mechanisms and Regulatory Implications of Oil Leakage into the Cabin Air Supply	S75
Susan Michaelis, John Morton	
GCAQE Meeting Introduction	S83

Margaret of Mar	
Hair Analysis: An Innovative Biomonitoring Tool to Assess Human Exposure to Tri-Cresyl-Phosphate (TCP)	S86
Vincent Peynet	
Moving Towards Total Cabin Filtration: Realtime Monitoring	S89
Chris Savage, Stephen Simpson, Paul Roux	
Aircraft Cabin Air and Engine Oil— An Engineering View	S93
Dieter Scholz	
Installation and Data Acquisition from a Real Time Air Quality Sensor (RTAQS) Monitoring Pilot Breathing Air	S99
Grant M. Slusher, Jennifer A. Martin, Brian A. Geier, Kathy L. Fullerton, Claude C. Grigsby, Darrin K. Ott	
A Win-Win-Win Path for Flight Safety, Health, and Corporate Profits	S104
Colin L. Soskolne	
Moving Towards Total Cabin Filtration: Filtering the Fresh Air Supply	S109
David Stein, Stephen Simpson, Paul Roux	
GCAQE Closing Speech	S115
Keith Taylor	
Organophosphate-Based Chemicals, Axonal Transport, and Cognitive Dysfunction	S118
Alvin V. Terry Jr.	
ICAO Circular 344 Guidelines on Education, Training and Reporting of Fume Events	S121
Antti Tuori	
REACH Substance Evaluation of TCP	S122
Petra van Kesteren, W.P. Jongeneel, N.G.M. Palmen, M. Beekman	
Tricresyl Phosphate Measurement Methods Used to Identify Flight Crew and Passenger Exposure	S124
Chris van Netten	
Use of Exposure Standards in Aviation	S132
Andrew Watterson, Susan Michaelis	
Mind the Gap? Identifying, Managing and Preventing Some Aircraft Crew Occupational Health and Safety/Flight Safety Problems	S138
Andrew Watterson, Susan Michaelis	

Copyright of proceedings is with GCAQE.

Copyright of papers is with individual author(s).

Creative Commons Attribution 4.0 International Public License (CC BY), <https://creativecommons.org/licenses/by/4.0>

Persistent identifier (resolved): <https://doi.org/10.5696/2156-9614-9.24.191201>

Short link: <http://bit.ly/AircraftCabinAir2017>

Archiving by Dieter Scholz (<http://www.ProfScholz.de>)

CONFERENCE SUPPORTERS



CONFERENCE ENDORSED BY



THEME

Aircraft contaminated air supply: The way forward

OVERVIEW

Aircraft air supplies in all current large passenger transport aircraft (apart from the Boeing 787), utilize non-filtered air (bleed air) drawn from the compressor stage of turbine engines to provide pressurization and breathing air. This design has been utilized since the 1950s and 60s. Synthetic jet engine oils and other fluids in aircraft systems are recognized and known to contaminate the bleed air supply, impacting flight safety, occupational and public health.

This conference followed on from the successful 2005 Air Safety and Cabin Air Quality International Aero Industry Conference held in London in 2005, which concluded that there was a workplace problem resulting in chronic and acute illness amongst flight crew (pilots and cabin crew) and expressed concerns that passengers may also be suffering from similar symptoms to those exhibited by the flight crew.

In the years after the 2005 conference, one cargo airline introduced a cockpit filter unit to filter the air supply to the cockpit. By 2016, with the same company now developing a potential new solution to filter all the air to the passenger cabin and cockpit, a new conference was organized to look at the current understanding of the issue and potential solutions for operators and regulators.

ORGANIZATIONS

The conference principal organizer was the Global Cabin Air Quality Executive (GCAQE), which was established in 2006 as a global coalition of health and safety advocates committed to raising awareness and finding solutions to poor air quality in aircraft. The conference was supported by Pall Aerospace and the following international worker

organizations: the British pilot union (PPU), Unite the Union (Britain's largest trade union), Air Canada Pilot Association (ACPA), Australian Federation of Air Pilots (AFAP), Australian International Pilots Association (AIPA), Association of Professional Flight Attendants (APFA), the International Transport Workers' Federation (ITF) and the University of Stirling. The conference was endorsed by the European Sealing Association, Collegium Ramazzini and the International Joint Policy Committee of the Societies of Epidemiology.

THE CONFERENCE PROGRAM

The conference program of the 2017 International Aircraft Cabin Air Conference included more than 30 oral and video presentations presented by scientists, doctors, pilots, cabin crew, engineers and experts from 11 countries covering a broad spectrum of topics. Most of these presentations are presented in this issue of the journal. The topics include engine design and mechanisms of oil leakage, flight safety, occupational health and safety, regulatory issues, risk management, international actions, reporting, medical and scientific evidence, jet oils, filtration, air quality sensors, legal implications and causation.

The following are a list of the papers presented at the 2017 International Aircraft Cabin Air Conference held at Imperial College London on September 19-20, 2017 in London in the United Kingdom.

Papers were formatted by Dr. Emma King (University of Stirling) and are presented in alphabetical order by corresponding author last name.

Neither the conference organizers or the Journal of Health and Pollution can be held responsible for inaccuracies or errors in any included papers.

'Fragmentation of Information' in International Data Gathering from Aircraft Fume Events

Arie Adriaensen

Vereinigung Cockpit, Frankfurt, Germany

Corresponding author:

Arie Adriaensen

arie.adriaensen@vcockpit.de

KEYWORDS

cabin air contamination, fume events, uncertainty, structural secrecy, fragmentation of information

ABBREVIATIONS

APU	Auxiliary power unit
BAe	British Aerospace
BFU	German Federal Bureau of Aircraft Accident Investigation
EASA	European Union Aviation Safety Authority
FAA	Federal Aviation Administration
ICAO	International Civil Aviation Organization
MOR	Mandatory occurrence reporting
PF	Pilot flying

ABSTRACT

This paper describes fragmentation of information problems in relation to information dissemination from bleed air contamination reports on aircraft. Chemical contamination of the bleed air supply system may cause crew impairment and can negatively impact flight safety. By comparing and contrasting official investigation reports with other information sources, the validity of the available information is scrutinized. The results display a lack of centralized data about fume events. Additionally, there is inconsistency between data from different sources. Fragmentation of information makes it difficult for pilots and decision makers to accurately assess the extent of the problem.

INTRODUCTION

The design of jet aircraft incorporates a bleed air system, which provides medium to high-pressure air bled from

the compressor section, prior to the burning chamber of the engines and the auxiliary power unit (APU). One of the main purposes of bleed air is to provide pressurization and air conditioning to the cockpit and cabin air. There are three ways that jet engine oil can contaminate the bleed air, being the air that is bled from the engine compressor stages to the cabin air that is delivered to passengers and crew: (i) by design: jet engines need minimal seal clearance to operate and thereby permit low level oil leakage into the aircraft cabin during normal flight operations; (ii) by seal bearing failure or minor systems failures, including worn seals; and (iii) maintenance irregularities or design deficiency.¹ This paper deals with the effects of the latter two categories, when noticeable amounts of jet engine oil or even externally ingested hydraulic fluid contaminate the aircraft occupants' breathing air. In recent years, there has been growing concern about the health and flight safety implications from such contaminations, which are commonly called fume events, or alternatively named cabin air contamination events. Fume events are hard to objectify in the absence of sensors and in the absence of safe limits for the specific chemical mixture from aircraft engine oil. Yet, many aircraft accident safety investigations identified oil leaks after crews reported health effects ranging from minor health effects, from impairments up to full pilot incapacitation. In several cases, health effects on passengers were reported.²

Reporting and learning from occurrences

Since the introduction of bleed air technology, there have been reports of pilot impairment and incapacitation,³⁻⁵ whereby the subsequent technical troubleshooting revealed the presence of jet engine oil or hydraulic fluid in the bleed air. However, the exact causative toxicologic mechanism is not known, which has allowed some aviation stakeholders to publicly doubt whether flight safety can even be affected by cabin air contamination.⁶ In the light of the number of reports and the degree of impairments described, doubting a causal link seems questionable and not in line with the duty of care one usually finds in flight safety matters. However, there is no global repository for fume event reports and the lack of access to one central database produces uncertainty in

the absence of the exact toxicological explanation.

Aviation reporting schemes are designed to learn in hindsight from the sum of cases that happen elsewhere, even if they happen beyond the operational boundaries of a particular airline, or across national borders. There are different levels on which regulators and aircraft accident investigation agencies react to pilot reports. At the initial level, pilot reports are gathered in national databases. At the second level, serious incidents will additionally escalate into an official investigation. Finally, if specific safety trends emerge, aviation authorities can decide to investigate further with summary reports or react by adapting the regulations.

The typical transparency produced by aircraft accident investigation disclosure is combined with 'share-your-experience' incentives from airlines and aviation authorities. Such incentives are intended to inform pilots about the risks they face by learning from similar previous incidents and accidents. The feedback loop that consists of reporting on the one hand and redistribution of information and mitigation on the other hand, encourages and rewards pilots for speaking up. Aviation reporting schemes and subsequent information dissemination have set a positive example for many other industries. Yet, in the case of fume events, as can be concluded from the findings of this paper, the existing 'share-your-experience' mechanisms suffer from what safety science calls an organization without a memory. Organizational memory loss happens when there are barriers to successful learning from incident reporting or, when the perceived lack of learning and the absence of change in practice might eventually further decrease the willingness of operators to contribute to incident reporting.⁷

Organizational uncertainty

There is a difference between intentionally produced organizational uncertainty and uncertainty as the result of unintentional mechanisms. Although there are several documented studies in relation to fume events where aviation stakeholders contributed to manufactured uncertainty, aligned with intended corporate or individual

benefits, it is not unlikely that at the same time airline managers and airframe manufacturers were simply unaware of the many reports and their severity from previous decades, and thereby themselves became a 'victim' of organizational memory loss.^{6,8,9} As opposed to manufactured uncertainty, unintentional organizational uncertainty has earlier been labelled 'structural secrecy' by Diane Vaughan's analysis of the Challenger space shuttle disaster.¹⁰ Her analysis was eventually issued as the book 'the Challenger Launch Decision', which described how a known criticality with the space shuttle O-ring seals during cold weather operations was not communicated to all NASA participants. With Vaughan's focus on sociological and organizational factors, she refuted the conventional explanation of a mere engineering and accountability problem, which was the earlier conclusion from the officially appointed Rogers Commission. As a part of structural secrecy, Vaughan described the principle of 'fragmentation of information' where within NASA, specific actors held technical information that the Challenger launch would not be safe and even warned against it, yet this information did not reach the team tasked with the launch decision. This breach of information flow eventually led to the explosion of the Challenger during its launch. Since Vaughan's seminal work, safety scientists have often examined whether 'structural secrecy' and 'fragmentation of information' can be recognized in other disasters. The aim of this paper is to show signs of the memory loss of a system as a whole in relation to fume events and show that fragmentation of information is a mechanism at play that leads to structural secrecy.

METHODS

The methodology of this paper consists of a desktop exercise, which re-iterates some findings from a previous Master's thesis about the topic of competing discourses in aircraft cabin air quality, written for the MSc 'Human Factors and System Safety' at Lund University, Sweden.

Information from the different levels of pilot report management as discussed in section 'Reporting and learning from occurrences' were studied. The most

important level to learn about the origin and severity of an aviation safety topic are aircraft accident investigation reports, because these investigations result from pilot reports, which have been escalated because of serious incidents or accidents.

A collection of all obtainable incident reports between 1996 and 2017 was the starting point of this desktop exercise. A total of 55 reports was retrieved from aircraft accident investigation units. National databases do not normally provide easy access for the general public. The UK Mandatory Occurrence Reporting (MOR) scheme provided easy access until rules of access changed recently. Therefore, the global collection of 55 investigation reports could be compared and contrasted with information from the UK national database containing those reports that did not escalate to an investigation.¹¹ Finally, a German summary report from the Federal Bureau of Aircraft Accident Investigation about the topic of cabin air contamination was consulted in relation to its evaluation of technical findings.¹² The German study covered occurrences of cabin air quality caused by bleed air contamination or alternative cabin air contamination sources (e.g. electrical fumes or galley-generated smells). For this paper, the data about the technical findings of suspected bleed air contamination events from incident reports was tabulated and compared against information from secondary information sources and checked for credibility and consistency.

RESULTS

The first sub-section in Results covers all investigation reports that could be identified in a 21-year period globally. The second covers some qualitative data from the same collection of reports. The third covers a UK collection of mandatory occurrence reports that did not escalate into an investigation. The fourth compares findings about a German BFU summary report and an airline report.

Investigation reports

The retrieval of incident reports was not a straight-

forward task. Looking through national databases and websites from national aircraft accident investigation branches using generic search terms such as smells, engine oil, fumes, fume events, smoke, haze, cabin air quality, and cabin air contamination gave fewer reports than those already retrieved by the author of this paper through other sources. Eventually, a network of scientific colleagues writing on this topic proved to be a more valuable source of available reports than national accident investigation accessible databases. Hence, there is no structured and systematic method for retrieving incident reports on the topic of cabin air contamination. Consequently, there is no way to make certain that the list of reports used in this paper is exhaustive.

The 55 investigation reports collected for this study between 1996 and 2017 were produced by a total of only 11 countries, of which Australia is the only non-European country to investigate the issue. The UK only produced half of the reports worldwide, 27 out of 55. The fact that entire continents or countries are not represented in the investigations is remarkable, because the literature and mandatory occurrence reports have described the same problems all over the world and in relation to all popular aircraft models with comparable frequency and gravity.^{8,13,14} One earlier study collected a total of 87 fume events in a single US airline during the 2-year period 2009-2010.² Those US events have no relation to the collection of incident reports from this conference proceeding. From these 87 events in the US, emergency medical care was required after 27 flights and follow-up medical care after 43 flights. Mechanical records confirmed that oil contaminated the air supply on 41 of the 87 suspected fume events.² However, not a single National Transportation Safety Board (NTSB) (US aircraft accident investigation branch) investigation about these US events could be retrieved by the author of this paper.

The 55 investigation reports from this study were analyzed for mechanical correlation with bleed air contamination. The distribution of technical findings is depicted in Figure 1.

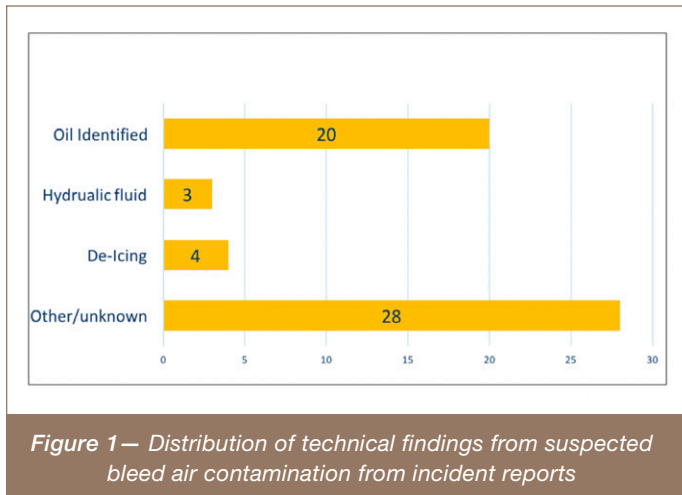

From the 55 incident reports that were analyzed, 27 reports were able to identify the presence of oil leaks or aviation fluids. The majority were engine or APU oil leaks. Only three discovered hydraulic leaks and another three identified de-icing fluid. Despite narrative descriptions of troubleshooting difficulties, mentioned in this collection of reports, the cause-effect relationship between the reports and the numerous identified oil leaks establish a pattern for half of the cases. A further statistical analysis remains impossible, because there was no comparable method of investigation among the reports.

The majority of the remaining reports in the category other/unknown could not identify a cause for reported smells, fumes, smoke, and/or symptoms. Only few of the reports searched for alternative conclusions. Some provided non-falsifiable conclusions, such as the possibility of residual oil contamination of the ducts from previous fume events.¹⁵ Such probable causes were not counted as a positive result in the positive identifications of bleed air contamination, so the positive identifications for engine oil and aviation fluid as depicted in Figure 1 remain a conservative count. The only positive verifiable alternative finding, which was not attributable to pyrolyzed engine oil, hydraulic or de-icing fluid, was provided by metallic parts from turbine blade fatigue that created smoke in the cabin. Even in this case bleed air design was responsible for the smoke entering the

cabin, but it was still counted under the ‘other/unknown category’ from Figure 1.¹⁶

Some reports hypothesized other possible sources, in the absence of hard proof, such as the widespread misuse of a toilet-cleaning agent for floor cleaning in one investigation, although such misuse could not be identified on this particular flight.¹⁷ A further report found the source of contamination to have resulted most likely from a chemical within the forward toilet servicing.¹⁸ These are examples of non-falsifiable hypotheses. This is also true for reports that have described the possibility of a physical-psychological related reaction in the absence of evidence of bleed air contamination. A German BFU report described possible contributing factors to be physiological and psychological effects on both crew members of massive smell development whose origin and spread could not be determined.¹⁹ The report counted 72 pages and looked into a multitude of sources but stated that a provable answer why two pilots became affected at the same time cannot be given.¹⁹ The investigation did not start until one year after the facts.

Investigation reports reveal a much wider history of events

Some reports from the collection in ‘Investigation Reports’ refer in their side marks to a much wider history of events. A report from the year 2005 describes how a Dash-8 filled with smoke due to a fatigue cracking of the compressor, allowing an oil leak into the bleed air.²⁰ The final report found that fume events still happened frequently, and the investigation attributed the majority of these cases to oil leaks:

“A search of the CAA database revealed that in the three-year period to 1 August 2006 there had been 153 cases of fumes, abnormal odor or smoke or haze in the flight deck and/or cabin of UK registered public transport aircraft of various types. Details on a number of the cases were limited but the available information suggested that around 119 of the cases had probably resulted from conditioned air contamination. This had commonly been caused by oil release from an engine, APU or air conditioning unit or ingestion of de-icing or compressor wash fluid by an engine or APU, with consequent smoke

and/or oil mist in the conditioned air supply to the fuselage. It appeared that in many of the cases the crew members had found it difficult or impossible to establish the source of the contamination.”²⁰

The excerpt above reveals that in a 3-year period, the UK aircraft accident investigation branch attributed 119 cases of fume events to conditioned air contamination for the UK only. Considering the fact that the Federal Aviation Administration (FAA), European Aviation Safety Agency (EASA), and the International Civil Aviation Organization (ICAO) have warned of the possible impact on flight safety,^{21,22} this substantial number of previously unknown events mentioned in a side comment is reason for concern. Another even larger series of occurrences was revealed in the final report of a Swedish investigation when BAe systems, the airframe manufacturer of an aircraft involved in a specific incident, was asked about previous problems and uncovered a whole series of previous events, exclusively on the BAe 146, in their description to the investigators.²³ Their frequency and safety impact explained in the report was significant:

“The aircraft manufacturer continuously follows-up submitted reports of disturbances from operators of the BAe 146 type of aircraft. The following information has been provided by the manufacturer. During the period from June-92 until January-01 a total of 22 cases were reported where the flight crew’s capacity had been impaired. Of these, seven have been judged as serious since they affected flight safety negatively. During the period from January-96 until September-99, 212 reports were submitted by a specific airline to the aircraft manufacturer concerning tainted cabin air. Of these, 19 reports concerned the impairment of the crew’s capacity. Seven of the reports were submitted directly by the crewmembers. From another 36 operators of the aircraft type a total of 227 occurrences relating to contaminated cabin air were reported during the period from May-85 until December-00. Of these, 11 reports concerned the impairment of the crew’s capacity”.²³

It is remarkable to see that hundreds of events, several of them with an impact on flight safety, were already

recorded before the millennium. But none of this information was communicated to the pilots affected by the flight under investigation. The pilots were not trained to react to and handle a fume event. The fact that the crew members only recognized the significance of what they were being exposed to until it was too late, whereas hundreds of similar incidents with the same aircraft model preceded it, confirm the premise of this article about a system without a memory. Organizational memory loss is created by fragmentation of information where extensive information is available to one side of the system (the manufacturer) but not to the actors that need to manage such events (the pilots). As the captain of the SE-DRE investigation testified: “[we] didn’t realize that we were being intoxicated before we were really ill”.²⁴ “Once I began to feel ill, things happened extremely quickly. If I hadn’t managed to get my oxygen mask on in 15 seconds, I would never have succeeded in getting it on. I was so ill that I couldn’t even lift an arm”.²⁴

UK mandatory occurrence reporting

Mandatory occurrence reporting (MOR) contain pilot narratives and possibly also technical findings. They are gathered by the national aircraft accident investigation branch, but usually not disclosed to the public as is the case with investigation reports. They provide the second information source for this study. A MOR collection of events from the UK over a 5-year period from 2001 until 2005 produced 37 identified cases of engine oil leaks and an additional 26 APU or engine oil overfillings out of a total of 227 suspected fume events with varying impact.¹¹ This creates a higher number of technical identifications of bleed air contamination over a 5-year period for a single country than the entire number of globally collected incident reports with a full investigation over a 21-year period from the ‘Investigation Reports’ section.

In 57 out of 227 UK MOR reports from this section, health symptoms of varying degree were reported. One particular case, where the captain collapsed after landing is provided below. The narrative from this report revealed a double pilot impairment, leading to subsequent identification of an oil leak. The problem was already

identified by the mechanics before departure, but the repair was deferred. The wording from the report is as follows:

“A strong smell of engine oil / fumes entered the flight deck during descent. The Captain became affected very quickly, felt very ill, was unable to concentrate and could not monitor the First Officer who was PF [Pilot Flying]. Nr1 engine bleed immediately switched off, with no further smell noted. Oxygen used, resulting in the Captain feeling better, but he deteriorated quickly again when oxygen was removed. PF landed the aircraft. After landing, the Captain collapsed in the rear galley.”

The root cause was found to be lower modification state seals, which allowed some engine oil into the ECS [Environmental Control System]. The seals were replaced and the system purged. An improved seal had been available which was being installed at engine shop visits. It was not however available in stock at operators main base.¹¹

Most countries do not make their mandatory occurrence reporting system accessible to the public. The UK allowed easy access until recently. From this UK MOR collection example, it becomes clear that both oil leaks and overfillings are frequent and the effects can be detrimental for flight safety. It also reveals that incident reports are not the only source of information that should be consulted as mandatory reporting schemes can easily outnumber technical findings gathered in incident investigations.

BFU study versus internal troubleshooting

The German Federal Bureau of Aircraft Accident Investigation (German official abbreviation: BFU) started a retrospective study after a series of German occurrences happened from which one received widespread media attention. The retrospective analysis covered an 8-year period from 2006 until 2013.²⁵ Root causes were adopted from technical causes transmitted by the operators and scrutinized in those cases were the BFU initiated an investigation. The BFU could only attribute a small portion to engine oil, APU oil, hydraulic

or de-icing fluid from a total of 663 findings. The sum of the table however only contains 659 events, from which engine oil or hydraulic and de-icing fluid are distributed as follows:

• Engine (not specified):	13
• Engine oil overfill:	3
• APU (Oil and De-icing fluid):	24
• Hydraulic and fuel lines:	9

Remaining categories with the remaining specify avionics fan, ECS fan, fire electrical systems, external contamination, coffee machine, oven, bird strike, etc.

If one adds all the oil leaks and hydraulic leaks for this 8-year period, the sum becomes 40. Note that the category APU merges oil and de-icing contamination. It should also be noted that the category of unsolved cases (undetermined/not known/none) represented the biggest part of the data totaling 431 cases.

The German Pilots Association Vereinigung Cockpit obtained an internal airline analysis from 167 technical logbook entries in relation to fume events from an airline staff member. They were collected over a 1.5 year-period and analyzed in 2009. The year 2009 falls within the 8-year range of the BFU study set up to collect all events. The incidents of the internal analysis should therefore also be reflected in the BFU study. In the document received by Vereinigung Cockpit, airline maintenance identified oil deposits in 58 cases, with the APU being the main culprit. This is a conservative estimate, because in 79 of the cases a mandatory service bulletin, which initiates a maintenance investigation after a fume event has not been performed. From these figures it becomes clear that one mid-size airline has collected more positive findings of engine and APU-related oil contaminations (58) after fume events in 1.5 years than the entire German airline industry has reported in an eight-year period to the BFU (40). Therefore, the statistics about technical root causes for fumes from the BFU report from 2013 cannot be maintained. It cannot be traced if these occurrences were within the 663 events already reported and their root causes were not transmitted or whether these

occurrences were simply not transferred to the BFU and should be added to the total. In both cases they would alter the total distribution of root cause findings considerably and question the validity of the rest of the figures. The positive identification of confirmed engine oil related problems would be more than double. One should be mindful that the biggest category of events in the BFU study was labeled undetermined / not known / none, covering 431 cases, which shows that the quality of data is insufficient for actual statistical conclusions. The airline analysis repeats a lack of data problem as the mandatory maintenance inspection was not performed in approximately half of the cases.

DISCUSSION

Some of the effects on crews from the mandatory occurrence reports narratives contained descriptions from health impairments that were substantial. The gravity of health effects on crews can therefore not be established as the commonly accepted trigger to start an investigation. In some of the full incident investigations health effects were completely absent, whereas in some of the mandatory reports without a full incident investigation report they had a negative impact on flight safety. Neither was the positive identification of an engine oil or hydraulic leak a commonly accepted trigger that escalates a pilot report into an investigation. From the analysis of all obtainable investigation reports it becomes clear that some countries do not investigate fume events at all, not even when jet engine oil leaks are confirmed, and both crew and passengers required emergency medical assistance.² Thus, there is a lack of a common basis to investigate fume events.

A recent paper from Shehadi, with the specific aim to characterize nature and frequency of the issue in order to collect meaningful monitoring data, approximates that 2 to 3 contaminated bleed air events per day happen in the US.¹³ A similar situation is to be expected in other areas of the world. Although the impact from fume events and their severity varies greatly, worst case outcomes reported full incapacitations or serious impairments from which the subsequent troubleshooting identified the

presence of oil in the bleed air. The fact that ICAO, the FAA and EASA have warned about the possible negative effects on flight safety creates enough reason for a more centralized collection about frequency, severity and technical correlation of fume events.

Flight crews that seem to rely the most on critical safety information are often uninformed about the existence and/or effects of fume events. This is supported by other authors that have revealed that many crew members are still not familiar with the issue.²⁶ Although this confirms the fragmentation of information effects, it is not clear if this uncertainty mainly belongs to the category of manufactured uncertainty, which is intended, or structural secrecy, which is the unintended consequence of opaque or broken organizational structures. Both types of uncertainty are intertwined and will amplify each other. Manufactured uncertainty in relation to fume events has already been provided in earlier studies.^{6,8,9}

Structural secrecy in the case of fume events is facilitated by the lack of a centralized repository. Fragmentation of information is among other things revealed by the fact that side-remark accounts contain hundreds of previous undisclosed events, or by the fact that internal airline analyses are not integrated in summary reports meant to map the problem. This creates structural uncertainty when studying fume events frequency and severity.

CONCLUSIONS

Fume events can create a serious risk to flight safety. The information gathered by aircraft accident investigation branches from the different sections of this paper should be better communicated to the pilot community by share-your-experience incentives. This paper focused on informational shortcomings in the reporting information collection and feedback system. However, technical solutions such as sensors to objectify the origin and severity of fume events should not be overlooked in conjunction with the above-mentioned organizational improvements.

Fragmentation of information effects not only influence

pilots, but also have an effect on the decisions from aviation authorities. Top decision makers tend to rely on signals as a shortcut, “a way of isolating bits of ‘telling’ information from what is available”.¹⁰ It is therefore also beneficial for regulators to update their variety of information sources and be aware of inconsistencies in outcomes from different information sources. This paper can help to achieve that goal.

References

1. Michaelis S. Oil bearing seals and aircraft cabin air contamination. *Seal Technol.* 2016;2016(4). doi:10.1016/S1350-4789(16)30104-0
2. Murawski J. Case Study: Analysis Of Reported Contaminated Air Events At One Major US Airline in 2009-10. AIAA 2011-5089. In: *41st International Conference on Environmental Systems 17 - 21 July 2011, Portland.* AIAA; 2011:1-11.
3. Kitzes G. Cabin Air Contamination Problems In Jet Aircraft. *Aviat Med.* 1956;27(1):53-58.
4. Gutkowski G, Page R, Peterson M. *D-14766-2. B-52 Decontamination Program.* Seattle: Boeing; 1953.
5. Montgomery M, Wier G, Zieve F, et al. Human Intoxication Following Inhalation Exposure to Synthetic Jet Lubricating Oil. *Clin Toxicol.* 1977;11(4):423-426.
6. Vakas N. Interests and the shaping of an occupational health and safety controversy: the BAe 146 case. 2007.
7. Sujan M. An organisation without a memory: A qualitative study of hospital staff perceptions on reporting and organisational learning for patient safety. *Reliab Eng Syst Saf.* 2015;144:45-52.
8. Michaelis S. Health and Flight Safety Implications from Exposure to Contaminated Air in Aircraft. 2010. <http://handle.unsw.edu.au/1959.4/50342>.
9. Woodley J. The politics of aircraft health and safety. 2005;21(5):401-407.
10. Vaughan D. *The Challenger Launch Decision: Risky Technology, Culture, and Deviance at NASA.* Chicago: University of Chicago Press; 1996.
11. CAA. *CAA Mandatory Occurrence Reporting (MOR) - Engine Oil Fume Events – UK AOC Aircraft.*; 2005.
12. BFU. *BFU 803.1-14. Study Of Reported Occurrences In Conjunction With Cabin Air Quality In Transport Aircraft.* Braunschweig: Bundesstelle für Flugunfalluntersuchung; 2014.
13. Shehadi M, Jones B, Hosni M. Characterization Of The Frequency And Nature Of Bleed Air Contamination Events In Commercial Aircraft. *Indoor Air.* 2015;26:478-488. doi:<http://dx.doi.org/10.1111/ina.12211>
14. Murawski J, Supplee D. An attempt to characterize the frequency, health impact, and operational costs of oil in the cabin and flight deck supply air on US commercial aircraft. *J ASTM Int.* 2008;5(5):1-15. doi:10.1520/JAI101640
15. AAIB. *AAIB Bulletin: 6/2007 G-CFAA EW/G2006/09/22.* Aldershot: Aircraft Air Accident Investigation Unit Ireland; 2007.
16. AAIB. *AAIB Bulletin: 6/2010, Embraer ERJ 190-200 LR (Embraer 195), G-FBEH, EW/C2008/08/01.* Aldershot: Aircraft Air Accident Investigation Unit Ireland; 2010.
17. AAIB. *AAIB Bulletin No: 9/96 Ref: EW/C96/4/3 Category: 1.1 Fokker 100, G-UKFF, 7 April 1996.* Aldershot: Aircraft Air Accident Investigation Unit Ireland; 1996.
18. AAIB. *AAIB Bulletin: 6/2008 G-JEBC EW/C2007/09/03.* Aldershot: Aircraft Air Accident Investigation Unit Ireland; 2008.
19. BFU. *Investigation Report:BFU 5X018-10-Airbus / A319-132. 19 December 2010.* Braunschweig: Bundesstelle für Flugunfalluntersuchung- German Federal Bureau of Aircraft Accident Investigation; 2015. [https://www.bfu-web.de/EN/Publications/Investigation Report/2010/Report_10_5X018_A319_Koeln-Bonn_Smell.pdf?__blob=publicationFile](https://www.bfu-web.de/EN/Publications/Investigation%20Report/2010/Report_10_5X018_A319_Koeln-Bonn_Smell.pdf?__blob=publicationFile).
20. AAIB. *AAIB Bulletin: 4/2007 G-JECE EW/C2005/08/10.* Aldershot: Air Accidents Investigation Branch; 2007.
21. ICAO. *Cir 344-AN/202. Guidelines on Education, Training And Reporting Practices Related To Fume Events.* Montréal: International Civil Aviation Organization; 2015.
22. FAA. *AD 2004-12-05: Airworthiness Directive.* Washington DC: Federal Aviation Administration; 2004.
23. SHK. *Report RL 2001 : 41e. Incident Onboard Aircraft SE-DRE. Sweden, 12 November 1999.* Stockholm: Statens haverikommission (SHK) Board of Accident Investigation; 2001.
24. Hansen A. Pilots knocked out by nerve gas. *Dagbladet.* 2006.
25. BFU. *Studie Über Gemeldete Ereignisse in Verbindung Mit Der Qualität Der Kabinenluft in Verkehrsflugzeugen.* German Federal Bureau of Aircraft Accident Investigation; 2014.
26. Jensen J, Hilde T. Fume Events in Aircraft Cabins - MSc Thesis. *Safety, Heal Environ.* 2015;(June).

Aerotoxic Syndrome: A New Occupational Disease?

Jonathan Burdon,¹ Susan Michaelis,²
C. Vyvyan Howard³

1 St Vincent's Private Hospital, East Melbourne, Australia

2 University of Stirling, Stirling, UK

3 University of Ulster, Ulster, NI

Corresponding author:

Jonathan Burdon

jburdon@bigpond.net.au

KEYWORDS

cabin air contamination, fume events, aerotoxic syndrome, bleed air, crew health

ABBREVIATIONS

OP	Organophosphate
TAPs	Triaryl phosphates
TBP	Tributyl phosphate
TCP	Tricresyl phosphate
TPP	Triphenyl phosphate

ABSTRACT

Pyrolyzed oil leaking through engine oil seals and entering the cabin air has prompted debate about exposure hazards to toxic substances. An investigation of ill-health among aircrew involved in contaminated air events was undertaken. Two studies were conducted to review the ill-health of affected aircrew. Findings were compared with published hazard databases, and relevant literature to assess compatibility with known toxicities. Acute and chronic exposures to thermally degraded substances was confirmed and supported by medical findings and diagnoses. We conclude a reasonable link between aircraft air supplies contaminated by engine oil and fluids and ill-health exists.

INTRODUCTION

In the mid-1950s civilian aircraft first started bleeding unfiltered air (so-called bleed air) from engine compressors into the cabin ventilation system. It was promptly recognized that air bled from the engine

compressors was contaminated with engine oil leaking into the cabin ventilation system. Hydraulic and de-icing fluids were also thought to be possible contaminants as a result of being drawn in through the engine air intake. Military studies found that the base stock of engine oils produced a wide variety of toxic substances as temperatures increase, i.e. when pyrolysed.¹ Reports of ill health among flight crew were soon observed.²

Turbine engines utilize synthetic lubricants that generally include an ester base stock (95%), a wide variety of triaryl phosphates (TAPs), organophosphate (OP) anti-wear additives (around 3%), amine antioxidants and proprietary ingredients (1–2%). The commercial formulation of the OP additive is generally cited as tricresyl phosphate (TCP).

Over the last 20 years, many ad hoc air-monitoring studies have been reported during normal engine operations. These have focused on TCP, which is routinely found in 25–100% of air samples taken during flights.³ Tributyl phosphate (TBP) was identified in 73% of flights, while low levels of TBP and triphenyl phosphate (TPP) metabolites have been found in 100% of urine samples.

Over the past two decades, there an increasing number of case studies and reports have been published but, sadly there has been considerable debate and controversy about the sources of contamination, the toxicity of the pyrolyzed volatile organic hydrocarbons and other substances in the bleed air, the consistency of the presenting symptoms and signs and argument about the causal mechanism.^{4–6} The debate about cause and effect seems to center on the observations that if the alleged contaminants are present in bleed air, their concentrations are below industry accepted standards and are, therefore, non-toxic, and that, even in the situation where there is no doubt about contamination, such as when there are visible or non-visible fumes in the cabin, a so-called 'fume event', the symptoms reported by the afflicted are so variable and non-specific, that to accept a single condition/disease as the explanation does not stand the test of scientific scrutiny. Thus,

the reported symptoms have been explained by some as being due to psychological problems, stress and hyperventilation and have been discussed elsewhere.⁷

We report here the results of two separate studies which were designed to determine if the symptoms and signs reported by aircrew exposed to suspected aircraft contaminated air events are consistent with exposure to jet engine oil and engine/aircraft fluids or other factors.

METHODS

Two studies were conducted as follows:

- Study A was undertaken in 2005-2009 and asked the question “What health effects are being reported in UK BAe 146 pilots exposed to contaminated bleed air?”^{8,9}
- Study B was undertaken in 2016 and sought to review well documented aircraft cabin air contaminated incidents to determine if the pattern and effects experienced, by those exposed, were consistent with the expected health effects of exposure to cabin air contaminated with engine oils, hydraulic or de-icing fluids and their pyrolyzed products or other factors.⁹
- Study A reviewed a group of pilots, their workplace environment and general health and specific symptoms.
- Study B differed from Study A in that it identified and addressed 15 separate specific contaminated air events, the associated symptoms and reported health effects per incident, rather than per person, as in Study A.
- Study A was a BAe 146 aircraft pilot health survey. United Kingdom Pilot Unions were requested to supply a list of all known United Kingdom certified BAe 146/146 Avro RJ aircraft (BAe 146) pilots. Attempts were then made to contact all those pilots listed by the Unions in order to conduct a telephone interview or written survey. Data were collected (by SM) from 2005 to 2009 on demographics, flying history, flight deck air quality history, health effects, medical diagnoses and other comments.

- Study B was a case study analysis of 15 potential cabin air quality incidents. The incidents were selected because they were reported to be consistent with acute hyperventilation and hypoxia and extensive data was available.¹⁰ Data sources included: airline, crew and maintenance reports; incident investigation and regulator reports; health effects and medical records; and media, union and legal reports. The incidents took place in Australia, Germany, the United Kingdom and the United States of America. Extensive data on the aircraft flight history, acute and long-term crew effects, medical diagnoses and findings, and maintenance findings were collated.

A table was then developed to categorize acute and chronic symptoms.

Substances utilized in the oils and hydraulic and de-icing fluids were then assessed against the European Regulation EC No. 1272/2008 on classification, labelling and packaging of substances (CLP) hazard classifications and hazard databases.¹¹ Symptoms were compared with published literature on cabin air, hyperventilation and hypoxia.

RESULTS

The results of study A were that contact details of 389 pilot names were supplied by the Unions. This number was 14% of the CAA 2002 licensed BAe 146 pilots. One hundred and fifteen of the 389 pilot details supplied could not be contacted because of the information was incorrect, wrong or out of date information. All 274 pilots contacted took part in the survey, a 70% response rate of the total names listed and 100% of those contacted. One hundred and forty-two reported specific symptoms and diagnoses, 30 reported adverse health effects, but provided no detail, while 77 reported no health effects and 25 failed to advise either way, resulting in 219 (80%) with assessable information.

Eight-eight percent (88%) of respondents were aware of the possible exposure to contaminated air in aircraft

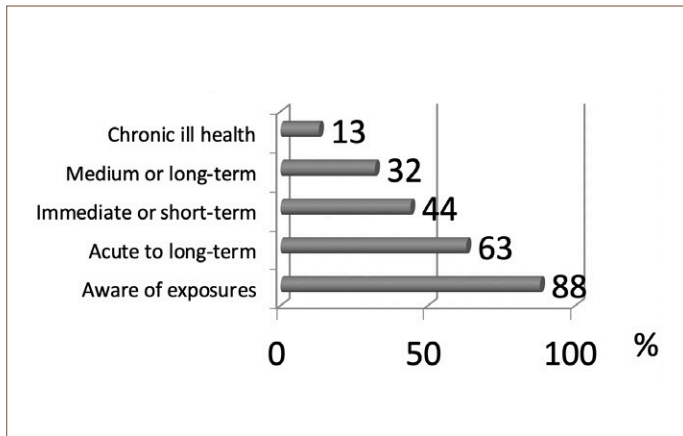

Figure 1 — Study A: Incidence of adverse health effects in pilots (n = 274)

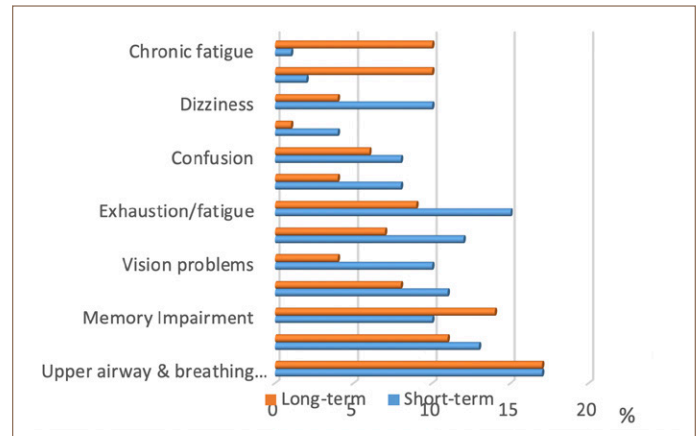

Figure 2 — Study A: Symptoms recorded in questionnaire

cabins. Thirty-four percent recorded frequent exposures, 18% reported exposure to one-two big events and 7% had experienced visible smoke or mist events. Immediate or long-term health effects were experienced by 63%, whereas 44% reported effects which lasted for a few days or up to about a week (Figure 1). These effects included symptoms of chronic fatigue, dizziness, confusion, disorientation, nausea and abdominal pain, headache, memory and cognitive impairment. Sinus and eye irritation and breathlessness and chest discomfort (Figure 2).

Operational findings of study B were that the 15 different incidents reviewed involved seven different types of aircraft in four different countries (UK, USA, Germany and Australia), with 53% being in the flight deck alone and 27% in both the flight deck and aircraft cabin. In 80% of events fumes only were detected. All events were reported to occur during non-steady state engine operations with 80% occurring during climb or descent. In 66% of the aircraft involved fume events had been reported either before or after the cases studied here. Maintenance finding reported positive oil leakage detected in 87%.

Medical findings of study B were that various degrees of incapacitation through to significant impairment in flight

was reported in 93% of the events, with the majority (73%) involving the pilots and in 33% both pilots were affected. Adverse health effects were experienced in at least one crew member in 75% of the 15 incidents, while passengers reported adverse effects in 27% of the incidents. In 53% of events, long-term health effects were experienced and in 47% of events 10-23 different symptoms were reported by the crew. Health effects were acute in 66% and chronic ill-health was experienced in 66%. Nine pilots were certified unfit to fly. Symptoms, diagnoses and ill-health effects reported are shown in Table 1.

The records related to Study B and long-term diagnoses are various and as expected based on the wide variety of symptoms experienced and are shown in Table 2.

DISCUSSION

Recognition of bleed air contamination was first reported in the 1950s and all current transport aircraft, except the Boeing 787, use the bleed air system to supply the cabin ventilation requirements. The common use of the engine compressor pressurized air to seal the oil-bearing chamber and as a source for the cabin bleed air supply provides a mechanism for low-level oil leakage in routine engine operations. Low-level leakage of oil

System	Symptoms reported
Neurological	
Central nervous system	Impaired or loss consciousness/headache/physical incapacity/paralysis/loss of balance/ataxia/visual impairment
Peripheral and autonomic nervous system	Tremor/incoordination/paraesthesia/numbness/peripheral neuropathy/sweating/loss of temperature control/pallor/flushing/taste impairment
Cognitive effects	Impaired problem solving Poor concentration Memory and writing issues Giggling/euphoria
Other systems	
Gastrointestinal	Nausea/vomiting/abdominal cramps/bloating
Respiratory	Breathlessness/cough/chest discomfort/wheeze/recurrent respiratory tract infection
Cardiovascular	Chest pain and tightness/irregular heart rate/hypertension
Skin	Rash/photosensitivity/blisters/alopecia
General	Arthralgias/generalised aches and pains/weakness/fatigue/feeling unwell/vocal and nasal symptoms/sinusitis
Malignancy	Various

Table 1 — Study B: Symptoms Reported After a Fume Event Exposure

- | | |
|--|--|
| <ul style="list-style-type: none"> • RADS/occupational asthma x 6 • PTSD x 3 • Neurotoxic injury x 1 • Toxic encephalopathy x 1 • Neuropathy on vocal chords/limbs x 3 • MCS x 1, CFS x 1 • Anxiety/depression x 1 • Cognitive dysfunction x 4 • Dementia x 1 • ADHD x 1 • Migraines x1 • Seizure disorder x 1 | <ul style="list-style-type: none"> • Depression x 1 • Aerotoxic Syndrome x 1 • Chemical injury at work x 1 • Neurological chemical injury x 1 • CNS injury x 1 • G4 GBM x 1 (deceased) • Wallerian degeneration x 1 • Vocal polyps x 1 • Heart attack + phosphate exposure x1 (deceased) • Frontal lobe damage x1 • Optic nerve damage x1 |
|--|--|

Table 2 — Study B: Long-Term Medical Diagnoses Recorded by Medical Staff

over the engine oil seals into the aircraft air supply at transient phases of flight in normal operations will occur, with less frequent higher level leakage under certain operational conditions, such as seal wear or seal failure.³ While many suggest oil leakage is only associated with rare failure conditions, others are now recognizing that chronic exposure to 'tiny' amounts of oil vapors leaking continuously over the seals occurs with engine power changes.^{3,12,13} Interestingly, the manufacturer of Study A aircraft have acknowledged that all engines leak oil and that their engines used to leak oil greater than the industry average and that there was a general health problem, but no flight safety issue!¹⁴

The experience of ill-health effects and, in some cases, serious clinical outcomes reported in our two studies reported here leads to the conclusion that there is a reasonable link between aircraft air supplies contaminated by engine oil and fluids and the development of acute and chronic ill-health and possible long-term impairment in some of those affected. A clear pattern of repeat low level exposures followed by acute events were identified, supporting acute on chronic effects. These findings suggest a cause and effect relationship. When the Bradford Hill causation criteria are applied to our studies,¹⁵ it is clear that eight of the nine criteria are met with only the dose response criterion not being upheld.⁸

In summary, it is now clear that bleed air from aircraft jet engines leaking into the air-conditioning system is harmful to health and is an important occupational health and safety issue which needs to be seriously addressed by airlines, the aircraft manufacturers and the regulators.

References

1. Treon J, Cappel J, Cleveland F, et al. The Toxicity Of The Products Formed by The Thermal Decomposition Of Certain Organic Substances. *Ind Hyg Q*. 1955;(September):187-195.
2. Loomis T, Krop S. *MLSR No. 61 - Cabin Air Contamination In RB-57A Aircraft*. Maryland: Army Chemical Center; 1955.
3. Michaelis S. Implementation Of The Requirements For The Provision Of Clean Air In Crew And Passenger Compartments Using The Aircraft Bleed Air System. MSc Thesis. 2016. <http://www.susanmichaelis.com/caq.html>. Accessed August 28, 2017.
4. Wolkoff P, Crump DR, Harrison PTC. Pollutant exposures and health symptoms in aircrew and office workers: Is there a link? *Environ Int*. 2016;87:74-84. doi:10.1016/j.envint.2015.11.008.
5. Harrison V, Mackenzie Ross S. An emerging concern: Toxic fumes in airplane cabins. *Cortex*. 2016;74:297-302. doi:10.1016/j.cortex.2015.11.014.
6. COT. *Position Paper On Cabin Air*. London: Committee Of Toxicity; 2013. <http://cot.food.gov.uk/sites/default/files/cot/cotpospapcabin.pdf>.
7. Burdon J. The "Aerotoxic Syndrome" — real condition or flight of fancy? *Aust New Zeal J Heal Saf Environ*. 2011;27(2).
8. Michaelis S. Health and Flight Safety Implications from Exposure to Contaminated Air in Aircraft - PhD Thesis. 2010. <http://handle.unsw.edu.au/1959.4/50342>.
9. Michaelis S, Burdon J, Howard C. Aerotoxic Syndrome : a New Occupational Disease ? *Public Heal Panor*. 2017;3(2):198-211.
10. Bagshaw M. *Health Effects of Contaminants in Aircraft Cabin Air*; 2015.
11. European Commission. *Regulation (Ec) No 1272/2008 Of The European Parliament And Of The Council Of 16 December 2008 On Classification, Labelling And Packaging Of Substances And Mixtures (CLP)*; 2009. <http://echa.europa.eu/web/guest/information-on-chemicals/cl-inventory-database>.
12. de Boer J, Antelo A, van der Veer I, Brandsma S, Lammertse N. Tricresyl phosphate and the aerotoxic syndrome of flight crew members - Current gaps in knowledge. *Chemosphere*. 2015;119(Suppl:S58-61). doi:[http://doi.org/10.1016/j.chemosphere.119\(2015\)S58-S61](http://doi.org/10.1016/j.chemosphere.119(2015)S58-S61).
13. Michaelis S. Oil bearing seals and aircraft cabin air contamination. *Seal Technol*. 2016;2016(4). doi:10.1016/S1350-4789(16)30104-0.
14. BAe Systems. *BAe Systems Evidence to the Australian Senate Inquiry. Air Safety and Cabin Air Quality in the BAe 146 Aircraft*. Canberra: Parliament Of The Commonwealth Of Australia; 1999.
15. Bradford Hill A. The Environment And Disease: Association Or Causation? In: *Proceedings of the Royal Society of Medicine*. Vol 58. Royal Society of Medicine Press; 1965:295-300.

Aircraft Cabin Air Supply and the Internal Air System

Peter RN Childs

Imperial College, London, UK

Corresponding author:
Peter RN Childs
p.childs@imperial.ac.uk

KEYWORDS

cabin, bleed, air, internal, turbine, compressor, system, electric, driven, contamination, oil

ABSTRACT

This paper describes systems commonly employed to deliver aircraft cabin air, and the internal air system which is responsible for the supply of balancing, sealing and cooling air used with the engine to control the operation of bearings, discs and other critical components, as well as bleed air. A series of mechanisms that could be responsible for contamination of bleed and cabin air are considered including: ingestion into the compressor intake of poor quality air; leakage from a seal of oil; ingestion from the gases associated with a stall or surge event; off-gassing of cabin fittings and emissions from occupants.

INTRODUCTION

Operation at high altitudes enables the efficient operation of a jet engine which improves with temperature ratio, pressure ratio and, in the case of a turbofan, by-pass ratio as well. A typical jet engine will comprise a compressor, combustor, turbine and jet nozzle. Air is drawn in through an intake and passes through a series of stages of stationary and rotating blades that guide and add rotational energy to the flow, thereby compressing it, prior to the air entering a combustor where fuel is added increasing the temperature of the compressed flow. Following the compressor, the gas flow passes through a turbine comprising a series of stationary and rotating blades which are designed to guide the flow and expand it allowing the energy within the flow to be converted to

rotational power, which is used to drive the compressor. If sufficient energy is added in the combustor, then the gas flow exiting the turbine will still have significant energy associated with it and this can be used to expand within a jet nozzle to produce thrust.

Different configurations of jet engine provide advantages for particular applications, with turbofans and turboprops common in modern passenger aircraft. In a conventional turbojet where all the gases that enter the intake pass through the combustor the exiting air from the jet nozzle will still contain substantial levels of energy associated with heating the gas flow. An alternative more efficient configuration is the turbofan where only a fraction of the intake air is heated in the combustor. This form of engine is used for the vast majority of modern jet engines. For short city hops or heavy lift configurations a turbo-prop can provide an efficient solution with a gas turbine engine driving a propeller which provides the thrust for the aircraft.

While the principles of operation of a jet engine can be understood in terms of the momentum change between the gases flowing into the engine and those exiting it, the detailed machinery involves a considerable number of subsystems and advanced engineering. Examples include the fuel system, oil system, cooling air system, balancing air system, compressor stages, combustors, turbine stages, engine nacelle, sensors and control systems. Texts such as Rolls-Royce and Saravanamuttoo *et al.* provide introduction and in-depth consideration of the fundamental operation of the jet engine.^{1,2} In this paper consideration of the subsystems relevant to the operation of cabin bleed off-takes and sealing of bearings for compressors is given. Section 2 provides an introduction to the internal air system of a typical gas turbine engine. Section 3 provides an introduction to options for the supply of aircraft cabin air. Section 4 explores potential scenarios for the contamination of cabin air.

Internal air system

The internal air system of a gas turbine engine whether for aviation or other purposes,³⁻⁵ serves a variety of

purposes including balancing of the thrust loads on discs, sealing of systems and providing cooling air and in the case of some aircraft cabin air. In order to provide the air necessary for these purposes bleeds from the compressor are made at various locations along the compressor, depending on the pressure required. The air is then supplied through a series of ducts and vents throughout the cabin.⁶⁻⁸ Compression of air requires energy and, in general, efforts are made to minimize such flows in order to minimize fuel consumption.

A key characteristic of the internal air system is the transfer of flow from one location to another. This will include oil, cooling and sealing air. For some components it is necessary to transfer air from a stationary component to a rotating component. Use is made of a variety of types of seal in order to exclude contaminants from a region of machinery or to aid the transfer of flow. Seals commonly used in gas turbine engine applications, where sealing is required between components rotating relative to each other, include labyrinth, brush and mechanical face seals.^{9,10} Each type of seal has its merits and under specified conditions can provide high levels of sealing performance. In general, a seal used between components with relative motion will permit some leakage. The level of leakage can be reduced by minimization of the running clearance between components and, if an additional source of high pressure supply is available, use of additional sealing air can, for example, be used to help ensure exclusion of a contaminant.

A typical bearing system in a gas turbine engine will comprise a rolling element bearing fed with a supply of oil in order to improve the wear characteristics of the bearing and remove heat. This oil will normally be provided in the form of a fine spray or continuously pumped into fine feed holes within the bearing. Excess oil will spill off the raceways of the bearing and be collected within a sump and a pumping system used to enable recirculation of this oil via a de-aerator and heat exchanger and filters so it can be used again. Seals are used either side of the bearing to minimize or prevent loss of the oil. Different types of seals are used in different regions of the engines with the choice

depending on parameters such as the nature of the fluid or particles to be contained or excluded, pressure levels, the level of sealing required, life, servicing, temperature of operation, running clearances, relative growth of components, space available and cost.

A key issue with operation of safety critical machinery is consideration of reliability and failure. Significant changes in the location of components in a gas turbine engine occur between start-up when the engine is cold and stationary and its running conditions at cruise or full power, due to temperature differences and centrifugal effects due to the high-speed rotation of the discs. These relative growths need to be considered in the detailed design of components and subsystems in combination with a desire to minimize the mass of the engines.³ As a result of such consideration significant use is made of interstitial seals such as labyrinth seals.⁹ These allow for relative motion between components but do involve some leakage which is a function of parameters including clearance between the fin tips and the casing, the pitch, angle, height and number of the fins, the sealing surface, eccentricity and pressure ratio. In the case of stepped labyrinth seals additional parameters include step height, configuration, distance from seal fin to step face and flow.¹⁰ Labyrinth seals can provide high levels of sealing functionality across a wide range of operating conditions and provide significant resilience in harsh environments. Use of stepped and blown configurations can further improve performance. Brush seals, which comprise a large number of small wire elements, can also be used in some locations, but can be susceptible to damage and blow through. Mechanical face seals, in theory provide a higher level of sealing. These seals comprise a sealing element such as a sprung carbon face running on a hydrodynamic film of lubricant. Such seals require relatively smooth levels of operation, in comparison to a labyrinth seal and are less resilient to vibration, run-out, eccentricity, and relative movement between components.

Cabin air supply options

A series of technologies have been developed to provide pressurized cabin air including use of:

- Oxygen tanks
- Turbo-compressors
- Auxiliary power unit (APU) driven compressors
- Bleed air from the compressor of a jet engine.
- Electrically driven compressors

Early high-altitude flights made use of pressurized oxygen tanks. Subsequently military and civil airliners used a radial turbine driven by exhaust gases to drive a centrifugal compressor or blowers to pressurize sufficient air for cabin use. The quantity of air required needs to be sufficient to provide replenishment of depleted oxygen levels, but also sufficient for provision of fresh air and management of heat levels. Typically, the cabin air system will comprise a network with some air recirculated augmented by fresh air supplied from a compressor. A proportion of the air entering the recirculation system is exhausted ensuring a continuous supply of sufficiently oxygenated air. FAR 25 mandates the supply of 0.55 lb/minute per passenger (see also Timby (1970)), which represents a considerable flow-rate for a typical passenger aircraft requiring a drive of a few hundreds of kilowatts. The auxiliary power unit, a small gas turbine engine used to drive a generator to provide electric power, can also be used to drive a compressor to supply cabin air or to augment a cabin air supply. An expedient solution for the supply of compressed air is to bleed this from the axial compressor of a turbojet or turbofan. This approach has been used in the majority of passenger aircraft over recent decades. Recently the Boeing 787 has implemented a system using electric motors to drive a compressor.

Concerns have been consistently raised with cabin air quality and studies offering diverse views on the subject.¹¹⁻¹⁶

Cabin air bleed contamination

A variety of mechanisms are plausible for contamination of cabin air depending on the system concerned. These include

1. Ingestion into the compressor intake of poor-quality air (re-ingestion of exhaust on the runway; ingestion of exhaust air from another aircraft on the runway; intake vortex ingestion; flight-path gas ingestion)
2. Leakage from a seal of oil (in operation or pooling of oil in a nacelle)
3. Leakage from a seal of oil from a worn or malfunctioning seal
4. Ingestion from the gases associated with a stall or surge event
5. Off-gassing of cabin fittings
6. Emissions associated with occupants.

When an aircraft is on a runway it is conceivable due to the direction of winds, that a proportion of exhaust gas is driven back towards an intake nacelle and re-ingested. Similarly, if an aircraft is following another aircraft closely on a runway ingestion of a small proportion of exhaust gases from the preceding aircraft is plausible. A jet engine or APU will emit a variety of substances formed by the high-temperature combustion of jet fuel during flight/taxiing in its exhaust including:

- water vapor,
- carbon dioxide (CO₂),
- small amounts of nitrogen oxides (NO_x),
- hydrocarbons,
- carbon monoxide,
- sulfur gases,
- soot and metal particles

As such if ingestion of a jet engine exhaust occurs, any or all of the above substances could enter the compressor and therefore enter the cabin, regardless of whether a bleed system is being used or an electrically driven compressor.

The large mass flows associated with a jet engine, can under certain conditions, lead to the formation of an intake vortex,⁵ with a highly swirling source flow located on the runway surface leading to ingestion of dust, debris and surface fluids into the engine nacelle. While a relatively rare occurrence, if such conditions were to occur for a cabin air system where the supply is derived from bleed air then there is a risk that any contaminants could enter the cabin air supply.

Air traffic management has resulted in the use of air traffic 'corridors' with aircraft flying in the vicinity of air previously occupied by another aircraft. The nature of the free vortex produced by wings which sweep up jet exhaust and wingtip flows means that the air disturbed by one aircraft remains associated with the free vortex for some period until it is dissipated. The period concerned for a free vortex to be dissipated can be orders of magnitude more than the initial disturbance that caused it.⁵ A potential mechanism for contaminated air entering into a compressor is ingestion of the dissipating exhaust gases from a previous aircraft that has flown through the airspace.

A bearing requires a continuous supply of oil in order to reduce friction and associated wear, and to remove heat. Oil is typically supplied continuously to a bearing and the used oil displaced or flung off the bearing is captured, cooled and filtered and recirculated in a bearing oil system.¹⁰ The nature of the seals whether mechanical, lip or interstitial means that some of this oil will leak out from the seal. In the case of mechanical face seals, the pads run on a hydrodynamic film of fluid. If there is, for example, vibration or a transient pressure difference it is plausible that some of the fluid associated with this hydrodynamic film could leak or be displaced from the seal. Indeed, the need to replenish or top-up oil for the majority of engine types indicates such losses, albeit small quantities. The layout of an axial compressor, the typical form of compressor used in a turbofan, makes a plausible pathway for such leakage oil to find its way into a bleed system highly tortuous and convoluted. Possible routes that might be possible, under a series of aligning conditions include surge and stall, where transient reverse flows occur in the mainstream, breakage, malfunction or substantial wear of a seal leading to large scale leakage flows, pooling of oil following a shutdown. If a seal is worn, or subject to a pressure differential outside its design scope it is likely that the flows through it will be substantially higher than expected with the potential for spillage of oil into regions of the engine not designed for its containment. In the case of fan and compressor bearings, it is conceivable that pressure differentials and centrifugal forces could result in such spilled oil, if it was

to occur, being spun around with the compressor drum assembly and if there are any abutment joints associated with this passing through these.

As indicated in the previous paragraph a bearing is supplied with a continuous flow of oil. If on shut down of an engine, the clearances are such that an egress of oil can occur, then it is plausible that this oil could pool in certain locations within an engine. The nature of a jet engine is that the exhaust has a smaller diameter than the intake. A further factor is that some modern engines have an asymmetric nacelle in order to accommodate the large diameter of the engine and provide adequate ground clearance. Either or both of these factors, combined with any leakage paths between cylindrical joints in the compressor drum or turbine assembly could result in pooling due to gravity of leaked oil in the vicinity of the front fan on the lower diameter of the engine nacelle. Such liquid on start-up could plausibly be spun around the compressor, especially given the low axial velocity components on start-up, and potentially be supplied to bleed offtakes. Such a situation could potentially be mitigated by operational practice and use of a ports to allow venting prior to ducting bleed air into a cabin.

Off-gassing of plastics and fabrics has been associated with some alleged incidences of sick-building syndrome.^{17,18} Tris (2-chloro-1-methylethyl) phosphate (TCPP) and other chemicals are included in some foams and polymer materials as fire retardants. It is plausible that some emission of polymer associated chemicals relating to seats, carpets and cabin surfaces could occur, especially with newly built aircraft. A further consideration for air-quality in a cabin is any emission associated with a cohort of passengers and crew due for example to use of fabric chemicals, and personal hygiene products.

It should be noted that the plausible mechanisms for possible contamination of cabin air described in this section are subject to conjecture. Although plausible this does not mean that any or all of these mechanisms do actually occur. Nevertheless, engineering practice involves detailed consideration of the possibility of a risk and its mitigation if there is likelihood of the risk

occurring. As such each of these mechanisms warrants consideration. The majority of the scenarios described could be wholly or partially mitigated by the use of filtration within a cabin recirculation system.

CONCLUSIONS

In order to provide adequate levels of fresh air to passengers and crew for aircraft flying at altitude a range of technologies have been developed typically employing either a dedicated driven compressor or bleeding air from a jet engine compressor. This paper has examined a variety of mechanisms that seem plausible for the possible contamination of cabin air depending on the system concerned. These include:

- Ingestion into the compressor intake of poor-quality air (re-ingestion of exhaust on the runway; ingestion of exhaust air from another aircraft on the runway; intake vortex ingestion; flight-path gas ingestion)
- Leakage from a seal of oil (in operation or pooling of oil in a nacelle)
- Leakage from a seal of oil from a worn or malfunctioning seal
- Ingestion from the gases associated with a stall or surge event
- Off-gassing of cabin fittings
- Emissions associated with occupants.

Each of the plausible mechanisms for possible contamination of cabin air described is subject to conjecture. All of the mechanisms apply in principle to compressor bleed systems. Several of the mechanisms apply in principle to a dedicated driven compressor cabin air system. The majority of the scenarios described could be wholly or partially mitigated by the use of filtration within a cabin recirculation system.

Disclaimer

Any opinions expressed in this paper represent those of the author.

References

1. Rolls-Royce. *The Jet Engine*.
2. Saravanamuttoo H, Cohen H, Rogers C, Straznicky P. *Gas Turbine Theory*. 6th ed. Prentice Hall; 2008.
3. Smout P, Chew J, Childs P. *ICAS-GT: A European Collaborative Research Programme on Internal Cooling Air Systems for Gas Turbines.*; ASME Paper GT-2002-30479, 2002.
4. Childs P. Gas turbine engine internal air systems. In: *1st International Symposium on Jet Propulsion and Power Engineering*. Kunming, China; 2006.
5. Childs P. *Rotating Flow*. Butterworth-Heinemann; 2010.
6. Wang A, Zhang Y, Sun Y, Wang X. Experimental study of ventilation effectiveness and air velocity distribution in an aircraft cabin mockup. *Build Environ*. 2008;43(3):337-343. doi:10.1016/J.BUILDENV.2006.02.024
7. Zhang T, Chen Q (Yan). Novel air distribution systems for commercial aircraft cabins. *Build Environ*. 2007;42(4):1675-1684. doi:10.1016/J.BUILDENV.2006.02.014
8. Wu C, Ahmed NA. A novel mode of air supply for aircraft cabin ventilation. *Build Environ*. 2012;56:47-56. doi:10.1016/J.BUILDENV.2012.02.025
9. ESDU. *Labyrinth Seal Flow.*; ESDU 09004, 2009.
10. Childs P. *Mechanical Design Engineering Handbook*. 2nd edition, Elsevier Butterworth Heinemann; 2019.
11. Hocking M. Passenger aircraft cabin air quality: trends, effects, societal costs, proposals. *Chemosphere*. 2000;41(4):603-615. doi:10.1016/S0045-6535(99)00537-8
12. Winder C, Balouet J. *Aerotoxic Syndrome : Adverse Health Effects Following Exposure To Jet Oil Mist During Commercial Flights*. In: Eddington I, ed. *Towards a Safe and Civil Society. Proceedings of the International Congress on Occupational Health Conference. 4-6 September, 2000. Brisbane*. ICOH; 2000.
13. DeHart RL. Health issues of air travel. *Annu Rev Public Health*. 2003;24:133-151. doi:10.1146/annurev.publhealth.24.100901.140853
14. McNeely E, Gale S, Tager I, et al. The self-reported health of U.S. flight attendants compared to the general population. *Environ Health*. 2014;13(1):13. doi:10.1186/1476-069X-13-13
15. Day G. *Aircraft Cabin Bleed Air Contaminants: A Review.*; 2015.
16. Omholt ML, Tveito TH, Ihlebaek C. Subjective health complaints, work-related stress and self-efficacy in Norwegian aircrew. *Occup Med (Lond)*. 2017;67(2):135-142. doi:10.1093/occmed/kqw127
17. HSE. *Workplace (Health, Safety and Welfare) Regulations 1992: Approved Code of Practice and Guidance L24*. HSE Books; 1992.
18. HSE. *General Ventilation in the Workplace. Guidance for Employers. HSG202.*; 2000.

Aircraft Operator Safety Case for Managing Fume Risk

Cliff Edwards

Independent Aviation Risk Management Consultant (Rtd), London, England

Corresponding author:

Cliff Edwards

cliff.edwards49@gmail.com

KEYWORDS

Bowtie analysis, safety management system, fume contamination, hazard management, fume risk

ABSTRACT

This paper is intended to offer a modelled approach for an aircraft operator to present the possible arguments for the management of risks of fume contamination of the cockpit or passenger cabin during operational flights of their aircraft. The primary approach in this paper is the Bowtie hazard analysis tool and the risk assessment matrix.

INTRODUCTION

Operating a public transport air transport organization carries corporate responsibilities and liabilities for senior management, in particular the accountable manager. In the current public transport regulatory environment there is a defined requirement for a safety management system, part of which includes a need to identify the risks and associated hazards that drive those risks. The accountable manager should be able to display an understanding of the risks that the organization faces, and the means to reduce or manage those risks to acceptable levels; this accountability cannot be delegated, albeit the actions to manage those risks can be assigned to others within the organization.

Cabin air includes by design the use of tapped engine air for both pressurization and cabin climate management. This tapped engine air contains particulates that can be

harmful to the passengers and crew, although generally in minor amounts that are either tolerable or of limited individual exposure. However, it is now recognized that there is a demonstrable risk that needs enhanced management, beyond those levels originally perceived. This paper sets out to enhance the understanding of this risk for aircraft operators through the use of a specific hazard analysis that could aid the air operator in meeting their corporate responsibilities.

Safety case

The safety case proposed herein is a simplified document that attempts to make fume risk management understandable to aircraft operators, flight crews and maintenance engineers, as these are the individuals that manage this risk and its associated hazards. The core element of this safety case is based upon a Bowtie hazard analysis and a single risk assessment. For aircraft operators, this risk and hazard combination forms part of their overall safety case or defined means of managing significant risks through the safety management system. However, for the propose of this presentation, it is focused on the single risk of fume penetration of the occupied spaces of the aircraft. Hazard analysis is a modelled approach that is not specific to any aircraft type or aircraft operator, but forms a generic document that could form the basis for any operator fume risk/hazard analysis.

Fume contamination may not be considered a major risk to the aircraft operator in their risk profile, but it should be assessed as it has the potential to affect the wellbeing of flight crews and passengers. In extreme cases it could result in fatalities and threaten the aircraft's ability to be safely landed.

The aircraft operator accountable manager is accountable for the management of risks. The level of risk is not the key issue, only that it exists and threatens the health of the occupants of the pressurized aircraft. That risk now needs to be acknowledged and managed by the individual operators. If not appropriately addressed, it can leave aircraft operators exposed to future challenges and potential liabilities. It is no longer possible to deny knowledge of this hazard any longer as

finally the evidence supports this potential problem.

Hazard analysis

The single Bowtie analysis identifies the hazard (the source of energy that needs to be controlled), the top event (the first point of release of the hazard) and a

number of threats that may cause control of the hazard to be partially or fully lost. Failure to contain through multiple threat controls, or alternately recover from the loss of control is also defined in the hazard analysis as a series of potentially worsening consequences (Figures 1 and 2).

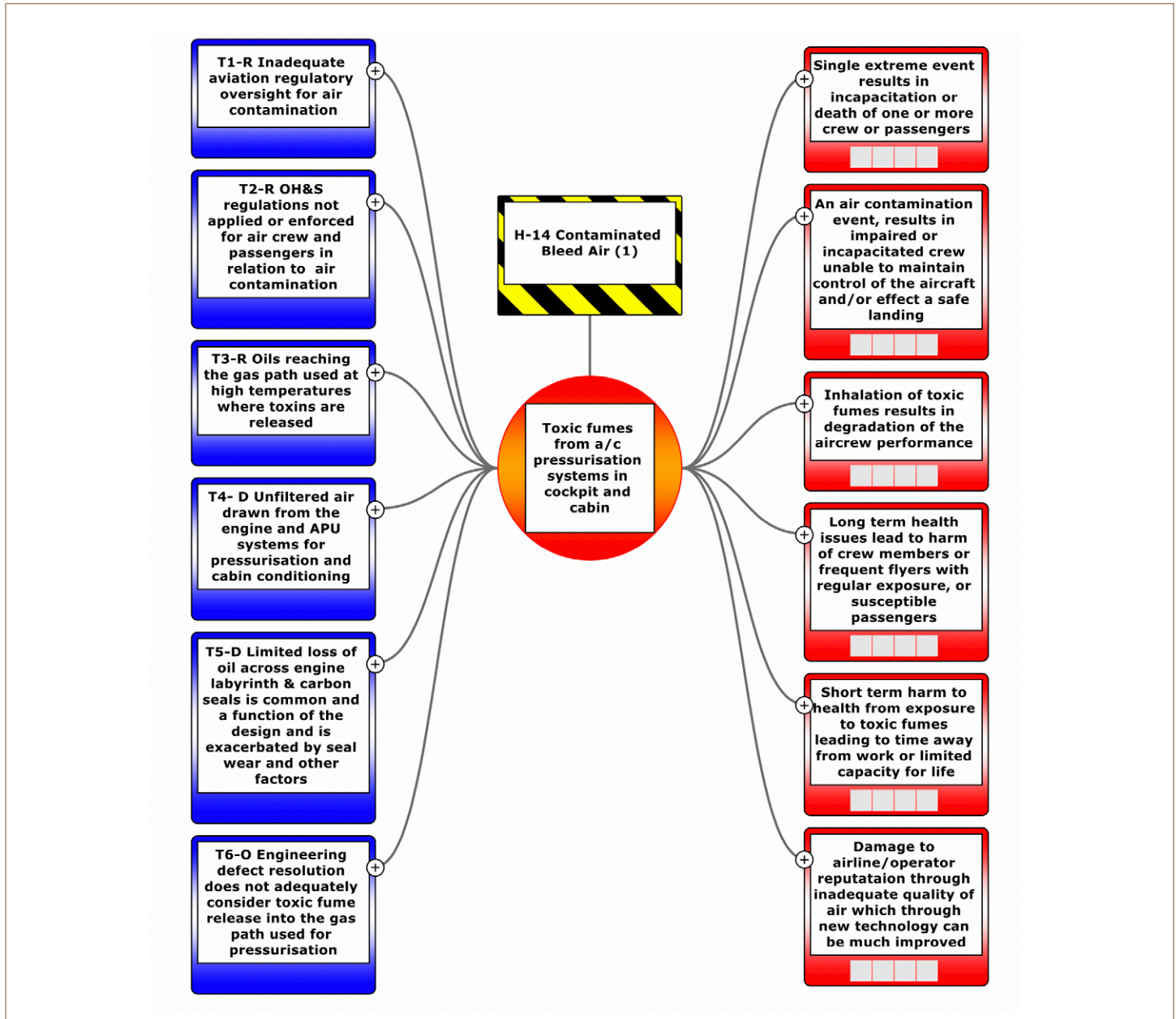

Figure 1 – Bowties Without Controls Depicted

Analysis components

1. Hazard: Contaminated Bleed Air
2. Top Event: Toxic fumes from aircraft pressurization and conditioning systems in cockpit and cabin.
3. Threats:
 - T1—Inadequate aviation regulatory oversight for air contamination. (Regulatory-based problem that does not currently require any monitoring or oversight at the point of design and build or during continuing operations).
 - T2—Occupational health and safety regulations not applied or enforced for air crew and passengers in relation to air contamination. (Regulatory-based problem where existing rules are not applied in aviation due to exclusions of regulators who might otherwise be actively pursuing this issue).
 - T3—Oils reaching the gas path used at high temperatures where toxins are released. (Design-based problem where oil manufacturers set temperature limits for the safe use that are exceeded as the potential effect is not considered).
 - T4—Unfiltered air drawn from the engine and APU systems for pressurization and cabin conditioning. (Design-based problem which is the common practice of almost all pressurized aircraft currently in use as the potential problems of contamination was not generally considered relevant).
 - T5—Limited loss of oil across engine labyrinth and carbon seals is common and a function of the design and is exacerbated by seal wear and other factors. (Design-based problem that is a fact of design of the seals but was not generally considered for its potential to contaminate the occupied space air).
 - T6—Engineering defect resolution does not adequately consider toxic fume release into the gas path used for pressurization. (Maintenance-based problem that has not been well understood or addressed by the maintenance community, or indeed called for by the manufacturers or regulators).

Top event

The left-hand part of a Bowtie hazard analysis is constructed with a series of control barriers that define the means to maintain control of all the threats and keep the operation in equilibrium. The Top Event (also known as the Hazardous Event) is at the center of the Bowtie and depicts the first point of loss of control, but at a point where control may be regained. The right-hand side of the Bowtie is designed to lay out the recovery measures needed to regain control of the hazard. However, they don't always work which would result in an unwanted outcome that can be minor or major in its results, these are known as consequences.

Consequences

The consequences of loss of control of the hazard may vary, but from a risk assessment consideration they are normally assessed as the worst creditable outcome or the most likely outcome. For the accountable manager it makes sense to document the worst credible consequence that the company may be held responsible for and if it is a lesser event at least the company should have been prepared.

CONCLUSIONS

This presentation is designed to assist aircraft operators with reinforcing their safety program by correctly identifying and subsequently managing a previously little understood hazard in normal operations. I set out to demonstrate the possible threats and controls needed to manage the hazard and avoid potential consequences. This is not necessarily a comprehensive answer to the problem and therefore each operator should consider the risks and hazards applicable to their company. Operators consider this identified risk for which they may well be held accountable in the future. Detailed copies of the generic safety case could be made available to aircraft operators that want to address the potential risks.

Have You Been Exposed to Aircraft Engine Oil? Candidate Biomarkers of Exposure

Clement E. Furlong,^{1,2} Judit Marsillach,¹ Michael J. MacCoss,² Rebecca J. Richter,¹ Thomas R. Bukowski,¹ Andrew N. Hoofnagle,³ Matthew G. McDonald,⁴ Allan E. Rettie⁴

1 Department of Medicine (Division of Medical Genetics), University of Washington, Seattle, USA

2 Department of Genome Sciences, University of Washington, Seattle, USA

3 Department of Laboratory Medicine, University of Washington, Seattle, USA

4 Department of Medicinal Chemistry, University of Washington, Seattle, USA

Corresponding author:

Clement E. Furlong
clem@uw.edu

KEYWORDS

Fume event, biomarkers, TAP exposure

ABBREVIATIONS

AChE	Acetylcholinesterase
BChE	Butyrylcholinesterase
TAPs	Triaryl phosphates
TCP	Tri-cresyl phosphate

ABSTRACT

Most aircraft flying today use bleed air to provide air conditioning to the aircraft. The problem with this design is that low levels of oil leak through the engine oil seals into the aircraft air in normal engine operation and when engine seals wear/fail, higher levels of oil mist enters the aircraft. Since the aircraft engine oil contains several percent of neurotoxic triaryl phosphates (TAPs) as anti-wear agent/fire retardant. Exposure to aircraft engine oil causes serious health problems to aircrew and passengers. This situation presents the following problems: 1) how is exposure documented, 2) are safer TAPs available or designable 3) why are some individuals more resistant to the effects of TAP exposure than others? 4) is treatment possible for TAP exposure?

INTRODUCTION

The toxicity of tri-cresyl phosphate (TCP) esters has been known as early as 1899.¹ Mixed TCP isomers, primarily of the meta- and para- isomers are used in aircraft engines as anti-wear additives in aviation engine oils.² Most commercial and military aircraft are designed to ventilate and pressurize the cabin and flight deck with air that is extracted (or “bled”) from the compressors in each engine. This design using pressurized air to keep the oil in the engine oil bearing sumps enables low levels of oil to leak through the engine oil seals into the aircraft air in normal engine operation and when engine seals wear/fail higher levels of oil mist enters the aircraft.^{3,4} This “bleed air” is not filtered, so when oil from the engine contaminates the ventilation fraction of the air, the aircrew and passengers are supplied with air contaminated with engine oil that contains 2.2-5.6% TCP mixed esters.² Debate between the airline industry and aircrew and passengers who have suffered neurological damage prompted this study that is aimed at documenting exposures to these mixed meta- and para- TCP isomers in aviation engine oil fumes. The methods employed in these studies make use of a rapid isolation of target biomarker proteins whose active site serine residues are susceptible to adduction by either the triaryl phosphates directly or by metabolites generated from the TAPs through a process termed bioactivation carried out by specific cytochromes P450. Antibodies specific for a given biomarker protein are covalently attached to paramagnetic beads (~2 μ diameter) allowing isolation of the target biomarker protein to a high degree of purity in a single step. The purified target proteins are cut into smaller peptides by specific proteases (usually trypsin) and analyzed by mass spectrometry (MS) which will not only quantify the modification on the active site serine but will also reveal the added mass of the adduct on the active site peptide fragment.⁵ Protocols have been developed for the rapid purification of several potential biomarker proteins for analyzing the extent of exposure to triaryl phosphates using MS to analyze the TAP modification of the active site serine residues of the

specific biomarker proteins. Earlier studies are reviewed that illustrate the potential toxicity of TAP exposures. Approaches for identifying potentially safer TAP anti-wear additives are discussed as well as a means of mitigating the conversion of TAPs to highly toxic metabolites. It is clear that exposure to aircraft engine oil and perhaps hydraulic fluid fumes represent a significant health hazard to both aircrew and passengers, and that exposure can also compromise flight safety when crews are impaired inflight. For existing aircraft, retrofitting the bleed air system with suitable filters may decrease the exposures of cabin occupants to hazardous chemicals. A better solution is that used in the Boeing 787, where bleed air is not used to provide air conditioning to the aircraft cabin. Clinical laboratory protocols need to be completed that will provide an accurate measure of an individual's exposure to the types of TCPs in oil fumes. Because there are other sources of TCP exposure in the environment (e.g., electronics, flame retardants), it will be important to collect baseline TCP exposure data from individuals who have not flown during a fume event for comparison purposes. Inter-individual differences in metabolism of toxic TAP molecules most likely explain the differential susceptibility to exposures. These individual differences need to be further explored. For example, the enzyme carboxylesterase varies widely among individuals and serves as an effective "sponge" for capturing toxic TAPs and their metabolites, such that a person with low levels of carboxylesterase may be more susceptible to toxic effects of TAP exposure, based on experiments reported by Grubič *et al.*⁶

METHODS

In response to queries from an airline pilot union starting in 2004, our research team committed to developing methods to document exposure to tricresyl phosphates onboard aircraft during an oil fume event. This paper describes the approaches to identify blood biomarkers of exposure to the blends of TCPs added to aviation engine oils ("D125"). Of note, the majority of TCP toxicity research-to-date has focused on either the single ToCP isomer or the combination of "ortho" isomers of TCP. However, because the total ortho isomer content of TCPs

in engine oils is expected to be less than 0.2%, we have purposefully focused our biomarker development work on the commercial meta/para TCP isomer blends, having obtained samples of the two blends added to these aviation oils.

RESULTS

A survey of smoke/fume incident databases maintained by the US Federal Aviation Administration (FAA) indicated that US airlines reported an average of 0.2 fume events per 1000 flights during the six-year period of January 1, 2007 to December 31, 2012.⁷ The reported fume events were specific for either oil or hydraulic fluid fumes in the bleed air. Based on the reported number of flights operated by US airlines during that period, the reported frequency calculates to 11,728 incidents during the 6-year period or 1,955 fume incidents per year, i.e. 5.4 incidents/day. Notably, US airlines are not required to report ground-based fume events or those events after which a mechanical fault was not identified. As such, the 5.4 incidents/day estimate only represents a sub-set of actual fume events. Still, this dataset illustrates that fume events are a daily occurrence on the US fleet. Further, under reporting has been widely recognized and the design of the oil system allows low level oil leakage in normal operations.^{3,4}

Do these fume events represent a public health problem as well as a significant safety issue?

The potential for flight safety to be compromised when airline pilots breathe oil fumes inflight has long been recognized.⁸ Airline flight safety regulators in Europe and Australia have attributed documented incidents of pilot impairment and incapacitation to inflight exposure to engine oil fumes.^{9,10} Other cases attribute increased pilot workload to the presence of oil fumes inflight.¹¹ In less-publicized oil fume events, crew unions in Europe, Australia, the US and Canada have received reports from pilots who describe significant impairment during essential phases of flight (usually descent and landing) during/after breathing oil fumes onboard. In some cases, pilots report symptoms consistent with exposure to asphyxiant compounds such as carbon monoxide

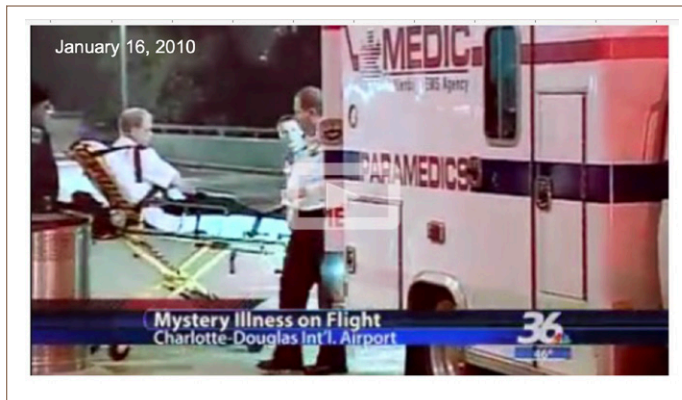

Figure 1 — US Airways Boeing 767-200, registration N251AY performing flight US-1041 from Saint Thomas (US Virgin Islands) to Charlotte, NC (USA) with 174 passengers. In March 2010 US Airways confirmed, that engine oil had leaked through a faulty seal into the bleed air supplying the air condition system. Both flight crew received permanent injuries.

and hexane. Figure 1 and published description of the fume event that appeared in *The Aviation Herald* (<http://avherald.com/h?article=425f6a41&opt=0>) indicate that fume events represent not only a public health issue, but a serious inflight safety issue.

In an earlier publication,¹² an epidemiological study based on flights where fume events have caused documented health effects to cabin crew was suggested. The suggestion appears below.

“The data presented in both the report for DfT by the Institute of Environment and Health (Cranfield Ref No YE29016V) and the ITCOBA Conference of 11 October 2011 quite clearly point to the need for more relevant studies on the effects of TAP exposure on aircraft occupants. The studies should include not only fume event-exposed aircrew, but also passengers who greatly outnumber exposed aircrew and include some of the more vulnerable members of society—the old, young, and unborn. There really is no need to set up more data gathering investigations as there have already been a large number of individuals exposed to significant fume events as shown in the literature and other reports documented by passengers and crew, which are in the public domain.^{13,14} Passenger manifests for flights

with documented and significant fume events involving engine oil would be a rich source for epidemiological studies. Reliable conclusions cannot be drawn from monitoring a small number of flights where no fume events occurred. The incident noted above, where two pilots lost their medical certificates and most of the crew have been unable to return to work many months later, provides an excellent example where the current health status of the passengers on the same flight would be highly informative, as would epidemiological studies on other similar flights where fume events have resulted in ill health of the air crew. Aviation regulators should promulgate and enforce passenger right-to-know regulations to enable passengers who have been exposed to engine oil fumes to seek appropriate medical care.”

Potential biomarkers from human blood for exposure to triaryl phosphates

Several proteins in human blood have been examined as potential biomarkers of TAP exposure. Plasma butyrylcholinesterase (BChE) has been used for many years as an indication of OP exposures, especially in the agricultural industry for a measure of OP insecticide exposure. Initial experiments carried out in our own laboratory and in collaboration with Dr. Oksana Lockridge from the University of Nebraska showed that while BChE was readily inhibited by the active metabolite of ToCP cresylbenzodioxaphosphorin oxide (CBDP), over a short period of time, the cresyl group was lost through an “aging” reaction, leaving only a phosphoserine at the active site of BChE. The same phenomenon was observed in blood samples from individuals who had flown recently.¹⁵ Following this observation, we looked for a blood protein that did not lose the cresyl group through the aging process after exposure to the D125 blend of commercial TCPs that is added to aviation engine oils. Other potential blood proteins that might serve as biomarkers for TAP exposure include acylpeptide hydrolase (APH) which is a useful biomarker for OP insecticide exposure, carboxylesterase which is highly sensitive to OP inhibition, however in blood, it is present in monocytes which have short half-lives of 1-7 days and neuropathy target esterase (NTE), the inhibition of which

is thought to be responsible for the paralysis observed following the consumption of ToCP contaminated ginger extracts during prohibition in the United States.¹⁶ We cloned the catalytic domain of NTE, expressed it in *E. coli* and found it to be quite unstable, making it more difficult to develop as a potential biomarker of TAP exposure. Further, paralysis does not appear to be a common symptom of exposures to TAPs used in the aircraft industry.

Evaluation of AChE as a potential biomarker for TCP exposures

Of the potential biomarkers of exposure available in human blood, AChE has two advantages: 1) it doesn't age with the loss of the cresyl group like BChE,¹⁷ and 2) it has a much longer half-life in blood, 33 d vs. 11 d for BChE. AChE does have a disadvantage of being less sensitive to inhibition by some OP compounds than BChE. Incubation of AChE with the active metabolite of ToCP, resulted in 170 mass units added to the peptide containing the active site serine of the AChE. Interestingly, while the inhibition of BChE requires bioactivation of the TAP, AChE can be inhibited by the un-bioactivated TAP.¹⁸

***In vitro* analysis of BChE by bioactivated TAPs**

Inhibition of BChE activity by various triaryl phosphates was used to identify potentially safer TAP anti-wear agents for aircraft engine oil. The results suggested that tri-*p*-cresyl phosphate and tri-*tert*-butyl phenyl phosphate did not generate inhibitors of BChE when bioactivated by an *in vitro* microsomal bioactivation system. These experiments were followed up by *in vivo* testing of tri-*p*-cresyl phosphate and the tri-*tert*-butyl-phenyl phosphate para isomer.

***In vivo* analysis of TAP inhibition of specific enzymes**

In vivo analysis of enzyme inhibition by feeding different TAPs to mice as a follow-on study to *in vitro* experiments aimed at identifying safer anti-wear additives for aircraft engine oils showed that tri-(*p*-*tert*-butylphenyl) phosphate generated the lowest level of inhibition of the three potential biomarker enzymes tested *in vivo* (plasma cholinesterase (BChE), acylpeptide hydrolase

and carboxylesterase. On the other hand D125 was a potent inhibitor of BChE, liver APH and plasma carboxylesterase. TpCP strongly inhibited plasma carboxylesterase and liver APH. Examination of the data from *in vitro* and *in vitro* inhibition indicates that it is important to follow up *in vitro* screening with *in vivo* analyses.

Why some individuals are more sensitive to TAP exposures than others

This is as yet an unsolved question. It is well-known that levels of specific cytochrome P450s vary from one individual to another and that mutations exist in cytochrome P450s that may increase or decrease activity against a given substrate. A fundamental question is whether higher rates of bioactivation (hydroxylation) of TAPs is beneficial or harmful to an individual--this question needs to be examined. It is clear that bioactivation of TAPs greatly increases the inhibition of plasma cholinesterase.¹⁹ However, it needs to be determined if the overall physiological effect of variation of level of given P450s on the toxicity associated with a given exposure is greater or less with rates of bioactivation. Variability in levels of other enzyme levels is also a relatively unstudied question. For example, carboxylesterase which readily interacts with TAPs varies in the human population by at least 18-fold.²⁰ Studies with rodents have shown that carboxylesterase levels are important in determining the toxicity of exposure to organophosphorus nerve agents, compounds with the similar enzyme inhibition properties to TAPs.⁶

Is it possible to mitigate an OP exposure?

As noted above, some enzymes are only inactivated by TAP metabolites generated by one or more cytochrome P-450s (bioactivation). Blocking the bioactivation step may serve to reduce the consequences of exposure. Naringenin, a natural component of grapefruit, inhibits the bioactivation of D125 to an inhibitor of plasma cholinesterase at physiologically relevant concentrations.¹⁹ This approach provides a simple screening step for approaches that may mitigate the consequences of TAP exposures. It also fact suggests that naringenin ingested subsequent to a fume event may

offer some protective effect by slowing or blocking the conversion of TAPs into more toxic metabolites. This can be tested experimentally.

Importance of blood sample analysis by certified clinical laboratories

The Clinical Laboratory Improvement Amendments (CLIA) regulate laboratory testing and require clinical laboratories to be certificated by their state as well as the Center for Medicare and Medicaid Services (CMS) before they can accept human samples for diagnostic testing. Thus, as we develop protocols for analyzing blood samples for analysis, it will be important to correlate with CLIA-certified laboratories for blood sample analysis. Ideally, there will be a number of laboratories worldwide that make use of standardized assays to analyze samples.

CONCLUSIONS

It is clear that fume events are an ongoing problem.² The approaches described here are aimed at 1) documenting TAP exposures, 2) understanding the physiological consequences of exposures, 3) understanding the genetic variability of susceptibility to TAP exposures, 3) addressing the possibility of safer TAP anti-wear additives, 4) examining possible treatments for mitigating exposures and 5) developing collaborations with certified clinical laboratories to analyze blood samples of exposed individuals to document TAP exposure.

Recommendations

A systematic survey of the neurological, respiratory, and other symptoms reported by crewmembers during and after documented exposure to engine oil fumes should be mandated by the appropriate regulators. In addition, regulators should ensure that passengers onboard incident flights are notified, provided with information to share with their doctors, and asked to report health effects so that the regulators (or some neutral third party) can collect and analyze incident-specific data in order to better define the health impacts of exposure. It is not too late to carry out such epidemiological studies.

References

1. EARL CJ, THOMPSON RHS. The inhibitory action of tri-ortho-cresyl phosphate on cholinesterases. *Br J Pharmacol Chemother.* 1952;7(2):261-269. <http://www.ncbi.nlm.nih.gov/pubmed/14954124>. Accessed March 6, 2019.
2. Hecker S, Kincl L, Mcneeley E, et al. *Cabin Air Quality Incidents Project Report*. Occupational Health Research Consortium in Aviation (OHRCA); Airliner Cabin Environment Research (ACER); 2014.
3. Michaelis S. Aircraft clean air requirements using bleed air systems. *Engineering.* 2018;10:142-172. doi:<https://doi.org/10.4236/eng.2018.104011>
4. Howard C, Johnson DW, Morton J, Michaelis S, Supplee D, Burdon J. Is a Cumulative Exposure to a Background Aerosol of Nanoparticles Part of the Causal Mechanism of Aerotoxic Syndrome? *Nanomedicine Nanosci Res.* 2018;139(1). doi:10.29011/JNAN-139.
5. Marsillach J, Richter RJ, Kim JH, et al. Biomarkers of organophosphorus (OP) exposures in humans. *Neurotoxicology.* 2011;32(5):656-660. doi:10.1016/j.neuro.2011.06.005
6. Grubič Z, Sket D, Brzin M. Iso-OMPA-induced potentiation of soman toxicity in rat correlates with the inhibition of plasma carboxylesterases. *Arch Toxicol.* 1988;62(5):398-399.
7. Shehadi M, Jones B, Hosni M. Characterization Of The Frequency And Nature Of Bleed Air Contamination Events In Commercial Aircraft. *Indoor Air.* 2015;26:478-488. doi:<http://dx.doi.org/10.1111/ina.12211>
8. Armstrong H. Chapter 11: Noxious fluids and gases in aviation. In: *Principals and Practice of Aviation Medicine*. Baltimore, USA: The Williams and Wilkins Company; 1939.
9. AAIU. *Air Accident Investigation Unit Ireland: AAIU Report No: 2016-013: Boeing 737-8AS, EI-EFB: 18 September 2014*. Dublin: Air Accident Investigation Unit Ireland; 2016. doi:10.1108/aeat.2002.12774cae.002
10. AAIB. *EW/C2006/10/08. AAIB Bulletin: 6/2009 G-BYAO*. Aldershot: Air Accidents Investigation Branch,; 2009.
11. AAIB. *AAIB Bulletin: 9/2018 G-VIIJ EW/G2017/11/13*. Aldershot: Air Accidents Investigation Branch,; 2018.
12. Furlong CE. Exposure to triaryl phosphates: metabolism and biomarkers of exposure. *J Biol Phys Chem.* 2011;11(4):165-171. doi:10.4024/28FU11A.jbpc.11.04
13. Murawski J. Case Study: Analysis Of Reported Contaminated Air Events At One Major US Airline in 2009-10. AIAA 2011-5089. In: *41st International Conference on Environmental Systems 17 - 21 July 2011, Portland*. AIAA; 2011:1-11.
14. Michaelis S. Health and Flight Safety Implications from Exposure to Contaminated Air in Aircraft. 2010. <http://handle.unsw.edu.au/1959.4/50342>.
15. Liasova M, Li B, Schopfer LM, et al. Exposure to tri-o-cresyl phosphate detected in jet airplane passengers. *Toxicol Appl Pharmacol.* 2011;256(3):337-347. doi:10.1016/j.taap.2011.06.016
16. Richardson R, Hein N, Wijeyesakere S, Fink J, Makhaeva G.

Neuropathy target esterase (NTE): overview and future. *Chem Biol Interact.* 2013;203(1):238-244.

17. Carletti E, Colletier J-P, Schopfer LM, et al. Inhibition Pathways of the Potent Organophosphate CBDP with Cholinesterases Revealed by X-ray Crystallographic Snapshots and Mass Spectrometry. *Chem Res Toxicol.* 2013;26(2):280-289. doi:10.1021/tx3004505

18. Richter et al. *Unpublished Data.*

19. Baker PE, Cole TB, Cartwright M, et al. Identifying safer anti-wear triaryl phosphate additives for jet engine lubricants. *Chem Biol Interact.* 2013;203(1):257-264. doi:10.1016/j.cbi.2012.10.005

20. Hosokawa M, Endo T, Fujisawa M, et al. Interindividual variation in carboxylesterase levels in human liver microsomes. *Drug Metab Dispos.* 1995;23(10):1022-1027.

Association and Causation: Bradford Hill Approach to Aerotoxic Syndrome

David Gee

Institute of Environment, Health, & Society, Brunel University, London, U.K.

Corresponding author:
David Gee
geedavid90@gmail.com

KEYWORDS

Bradford hill, aerotoxic syndrome, harm prevention, causality

ABBREVIATIONS

AS Aerotoxic syndrome

ABSTRACT

Causality in the tobacco and lung cancer controversy is briefly reviewed as background for Bradford Hill's seminal 1965 paper on "Environment and Disease: Association or Causation?" in which he identified nine features of evidence that can help us to identify a robust causal inference.¹

In applying these features to the Aerotoxic Syndrome (AS) evidence it is concluded that Bradford Hill would probably have assigned "fair" evidence for AS causality. Given the nature, extent, and seriousness of possible AS harm to crew and passengers, this strength of evidence is sufficient to take action to reduce the likelihood and extent of harm.

INTRODUCTION

"In occupational medicine our object is usually to take action" in order to prevent, as opposed to belatedly observe, harm.²

Sir Austin Bradford Hill, then Chief UK Medical Statistician, was addressing his fellow Occupational Physicians in early 1965 about the experiences and insights he had gained from the early years of the tobacco controversy. This controversy had broken out in 1950 when he and Richard Doll had produced preliminary

results from their study of British doctors which looked at their smoking habits and their lung cancer experiences. Their conclusion that they had found a "real association between carcinoma of the lung and smoking" was not immediately popular with the UK medical establishment, partly because most of the male doctors were then smokers.

However, by 1957, the UK Medical Research Council (MRC) had concluded, on the basis of additional positive evidence, that "a major part of the increase (in lung cancer) is associated with tobacco smoking, particularly in the form of cigarettes.....the most reasonable interpretation of this evidence is that the relationship is one of direct cause and effect".²

By 1964, the scientific debate was closed for relevantly informed and independent scientists when the US Surgeon General's Committee reviewed some 30 epidemiological studies, several positive animal studies, and some cell studies and had concluded that smoking caused cancer.

Note that both the MRC and the US Surgeon General reports considered association and causation as part of a continuum: "does the association have a causal significance?"³ This is to be determined by a judgement on the evidence. The dichotomous formulation by Bradford Hill, association or causation, has arguably encouraged sceptical scientists to withhold a verdict of causation until the evidence is very strong, by which time only some late harm can be prevented, instead of the earlier harm that action on reasonable evidence would have prevented.

The Bradford Hill approach to evidence and action

In Bradford Hill's still widely used seminal paper of 1965 which focuses on how we can move from an observed association to a robust causal inference, he identified nine "features" (often misnamed as "criteria") of the available, and often "ragged", evidence which, if present, could help justify a robust causal inference.⁴

Bradford Hill was careful to point out that if these

features of the evidence (Table 1) were absent, then that did not justify concluding that the agent being evaluated was not causing harm.

In other words, the features of the evidence were *asymmetrical*, a word he did not use despite making the conceptual point very explicit when discussing several of the features of the evidence.⁵

In coming to evaluate the current evidence on a completely new subject for this author (DG) i.e. that of AS,⁶ it will be helpful to apply the Bradford Hill approach to the question of causality, and adopt his concluding approach to harm prevention.

This last step was clearly articulated in the final section of his 1965 paper, the “Call to Action”. There he identified the need for case specific “*differential standards*” for the different *strengths of evidence* needed to justify actions that would reduce the likelihood and extent of harm.

He illustrated this point by giving three examples. For example, “*slight evidence*” he thought would justify banning a widely used pregnancy pill if the preliminary evidence included indications of serious birth defects. (He was writing as the thalidomide pregnancy pill and birth defects tragedy of 1962 was unfolding).

“*Fair evidence*” he thought would be needed to justify reducing or eliminating exposure to a *probable* carcinogenic oil at work, where the costs of acting prematurely, or wrongly, would be much greater than in the pregnancy pill example. However, “*very strong evidence*” would be needed to justify a government forcing “*people to burn a fuel in their homes that they do not like, or stop smoking the cigarettes and eating the fats and sugar that they do like*”. (Bradford Hill was way ahead of his time...).

He noted that in choosing the appropriate and case specific strength of evidence needed to justify action, the key consideration was the plausible *consequences of being wrong* in acting, or not acting, in a timely manner to prevent harm. In the case of the pregnancy pill ban:

*“If we are wrong in deducing causation from association then no great harm will have been done. The good lady and the pharmaceutical industry will doubtless survive”.*¹

Of course, much knowledge has been gained since 1965 but the Bradford Hill approach is still deemed by most relevantly informed scientists to be robust in the face of emerging evidence of harm.⁷⁻¹³

This is so even in the current contexts of the complexity, variability, uncertainty, and multi-causality that usually characterise health and environment controversies, such as the 34 case studies analyzed in “*Late Lessons from Early Warnings*” by the European Environment Agency.^{14,15}

There are many similarities between AS and the EEA hazard stories. For example, as with the AS case, “*no evidence of harm*” can be misinterpreted to mean “*evidence of no harm*”. This is usually not so because no, or very little, relevant, reliable, and long term research evidence is available, (as is still the case for AS) or because of the limitations on what *could* be known with existing scientific methods, under conditions of complexity, variability, and multi-causality.^{15,16}

Applying the Bradford Hill approach to Aerotoxic Syndrome

So, as to causality, what might Bradford Hill have concluded after applying his approach to the evidence available in 2017 on AS, were he to be around?

He would first have approached the evidence with this observation and question: “*The ‘cause’ of illness may be immediate and direct, it may be remote and indirect... But...the decisive question is; whether the frequency of the undesirable event B will be influenced by a change in the environmental feature A?*”.

As he was an assiduous student of history, Bradford Hill would first have noted that an informed warning about the potential hazard of AS came very early after the engineering innovation of replacing the cabin air taken from outside the aeroplane to taking it off the air intake to the engines:

“The observations of the flight crews constitute the first

Strength of association: case studies and clinical data indicate clear health impacts in significant proportions of exposed groups

Consistency: clinical data consistent with known toxic effects of organophosphates (OPs); and across varying aircraft types /countries

Specificity: AS is a syndrome (like AIDS; Multiple Chemical Sensitivity ; Occupational Asthma; Gulf War and Autism syndromes) and with common neurological/respiratory symptoms linked to oil leakage/pyrolysis products exposure in cabin air

Temporality: cabin air contamination precedes linked health effects

Biological gradient: more contaminant exposure often causes greater health effects; but low dose effects also apparent, suggesting non-linearity

Plausibility: known effects of Ops and other cabin air contaminants support a causal link

Coherence: animal/human data support a causal link

Experiment: health effects are often reversible after exposure cessation

Analogy: Polychlorinated biphenyls (PCBs); hot rubber fumes; welding fumes; traffic fumes, occupational asthma, leaded petrol, methyl mercury, OP pesticides, tobacco smoke have relevant features

Table 1 – The Bradford Hill Approach Applied to Aerotoxic Syndrome 2017

*evidence of the existence of the problem. They have repeatedly reported presence of smoke and odor in the occupied compartments of the airplane”.*¹⁷

This early warning, like most of those in the 34 case studies analysed in the “Late Lessons from Early Warnings” reports,^{14,15} was not heeded, even after later warnings became available:

“...the Propulsion folks do not account or certify the bleed air quality....GE and RR engine specs do not mention bleed air quality when it comes to CO/CO₂ or hydrocarbon by-products.... With all diversions (about one every two weeks) and return-to-base events due

*to haze in the cabin, (from failed fan and forward IPC bearing oil seals allowing oil by-products)..... I would have thought the FAA would have made the engine manufacturers address this by now”.... “Bottom line is, I think we are looking for a tombstone before anyone with any horsepower is going to take interest.”*¹⁸

This preliminary, if largely anecdotal but informed evidence from inside the aircraft industry would certainly have stimulated Bradford Hill to quickly evaluate all of the available scientific and other evidence in order to help prevent, or minimise, harm to aircraft crews, pilots and passengers.

In contrast, regulatory authorities on AS seem to be following the pattern set in most of the case studies in the “Late Lessons” reports.^{14,15}

For example: “we can see nothing in this most recent or previous evidence that provides clear and consistent evidence of causal long-term health effects”.¹⁹

Depending on the economic and other interests at stake, the acceptance of causal evidence by regulatory authorities usually comes late, or very late, in the day.

In his review of the AS evidence, Bradford Hill would have been looking for the most likely interpretation of the evidence, guided by his questions: “*What aspects of that association should we especially consider before deciding that the most likely interpretation of it is causation?*” And “*In what circumstances can we pass from this observed association to a verdict of causation?*”

Bradford Hill would not have been impressed by the argument that if we do not know *how* A causes B then we should not accept that A *could* cause B.

“How such a change exerts that influence may call for a great deal of research. However, before deducing ‘causation’ and taking action we shall not invariably have to sit around awaiting the results of that research.”

And, for this feature of the evidence, Bradford Hill cautions us to note its asymmetric quality: “*Biological plausibility depends on the knowledge of the day ... a feature of the evidence that we cannot demand*”. He reminded us that an observed association “*may be new to science, or medicine, and must not therefore be too readily dismissed as implausible or even impossible*”.

In other words, if present, biological plausibility is a feature of evidence that can be useful in helping to infer causality, but if absent, we cannot infer non-causality with similar confidence.

Given what we now know about multi-causality and complexity in biological systems,²⁰ the asymmetry of all his features of evidence is now larger than in 1965.

Bradford Hill was similarly sanguine about the weight to put on the absence of statistical significance: “*Too often I suspect we waste a great deal of time, we grasp the shadow and lose the substance...we weaken our capacity to interpret the data and to take reasonable decisions whatever the value of P.*”

There have been many subsequent warnings about the misuse of statistical significance, but they too are often ignored.²¹

So, what would Bradford Hill have concluded from looking at the AS evidence in 2017?

Table 1 applies Bradford Hill’s nine features to the AS evidence available to this author in 2017.^{6,22}

This is not a *systematic review* of the AS evidence: such a review of the AS evidence is now clearly needed using recent methodologies.^{23,24}

This review is, however, a quick and tentative attempt to illustrate what interim conclusions Bradford Hill might have drawn from looking at the AS evidence available in 2017, where he to be around.

CONCLUSIONS

In my opinion, Bradford Hill would have most probably concluded from Table 1 that:

- the overall weight of evidence supports a causal link between aircraft cabin toxics contamination and health effects in some crew and passengers;
- the link is more likely than not i.e. at or around the “balance of probabilities” or “*fair*” strength of evidence;
- a high-quality case-control study is urgently needed;
- there needs to be an independent systematic review of the current AS evidence;
- pending this new research, action should now be taken to adequately monitor aircraft cabin air quality; and
- to remove hazardous contaminants (as I understand Boeing have now done with their new Dreamliner

aircraft which has reverted to taking air from outside the plane); and

- to adequately compensate the victims via a no-fault scheme (similar to that between the unions and British Nuclear Fuels for radiation induced cancer, 1985).

Perhaps the AS evidence is now somewhat similar to that on-air pollution and autism spectrum disorder in 2015?

*“Given the general consistency of findings across studies, and the exposure window of specific associations recently reported, the overall evidence for a causal association between air pollution and ASD is increasingly compelling”.*²⁵

It may also help, and would certainly be novel, if there were to be a “*Frequent Flyers Citizens Jury*” on AS using the tried and tested methods developed by the Danish and Canadian authorities.²⁶

Bradford Hill concluded his fine paper by reminding us that:

*“All scientific work is incomplete... that does not confer on us the freedom to ignore the knowledge we already have or to postpone the action that it appears to demand at the given time”*¹

Is this “freedom” to avoid using the available knowledge on AS being over-exploited by regulatory authorities and the aircraft industry? And, will it take a “tombstone” to shake their assertion that there is no “clear and consistent” evidence of harm from aircraft cabin air pollutants?

References

1. Bradford Hill A. The Environment And Disease: Association Or Causation? In: *Proceedings of the Royal Society of Medicine*. Vol 58. Royal Society of Medicine Press; 1965:295-300. <http://www.ncbi.nlm.nih.gov/pubmed/14283879>. Accessed February 21, 2019.
2. Medical Research Council. Tobacco smoking and lung cancer. *Br Med J*. 1957.
3. US Dept of Health Education & Welfare: Advisory Committee on Smoking & Health. *PHS Report No 1103*. Washington; 1964.
4. Vandenbroucke J, Broadbent A, Pearce N. Causality and causal inference in epidemiology - the need for a pluralistic approach. *Int J Epidemiol*. 2015;1-12.
5. Gee D. Establishing evidence for early action: the prevention of reproductive and developmental harm. *Basic Clin Pharmacol Toxicol*. 2008;102(2):257–266.
6. Michaelis S, Burdon J, Howard C. Aerotoxic Syndrome : a New Occupational Disease ? *Public Heal Panor*. 2017;3(2):198-211.
7. Neutra RR, Cranor C, Gee D. The Use and Misuse of Bradford Hill in American Tort Law. *Jurimetrics*. 2018;58(2). doi:10.1289/isesisee.2018.p02.3730
8. Ritz B. Evidence re Glyphosate & cancer, Case 3:16-md-02741-VC Document 546-9 Filed 10/06/17. Presented at the: 2017.
9. Rothman K, Greenland S. Causation and Causal Inference in Epidemiology, American Journal of Public Health. *Am J Public Health*. 2005;95(S1).
10. Weed D. On the logic of causal inference. *Am J Epidemiol*. 1986;123:965–979.
11. Fedak KM, Bernal A, Capshaw ZA, Gross S. Applying the Bradford Hill criteria in the 21st century: how data integration has changed causal inference in molecular epidemiology. *Emerg Themes Epidemiol*. 2015;12:14. doi:10.1186/s12982-015-0037-4
12. Olsen J, Jensen UJ. Causal criteria: time has come for a revision. *Eur J Epidemiol*. 2019;34(6):537-541. doi:10.1007/s10654-018-00479-x
13. Dekkers OM. The long and winding road to causality. *Eur J Epidemiol*. 2019;34(6):533-535. doi:10.1007/s10654-019-00507-4
14. European Environment Agency. *Late Lessons from Early Warnings: The Precautionary Principle 1896-2000*. Copenhagen; 2001.
15. European Environment Agency. *Late Lessons from Early Warnings: Science, Precaution, Innovation*. Copenhagen; 2013.
16. Grandjean P. Science for Precautionary Decision-Making. In: *Late Lessons from Early Warnings*. Copenhagen: European Environment Agency; 2013:517-535.
17. Gutkowski G, Page R, Peterson M. *D-14766-2. B-52 Decontamination Program*. Seattle: Boeing; 1953.
18. Bates G. *Personal Communication.*; 2007.
19. Clarke S. *Aerotoxic Syndrome.*; 2017.
20. Gwinn MR, Axelrad DA, Bahadori T, et al. Chemical Risk Assessment: Traditional vs Public Health Perspectives. *Am J Public Health*. 2017;107(7):1032-1039. doi:10.2105/AJPH.2017.303771
21. Wasserstein RL, Lazar NA. The ASA’s Statement on p-Values: Context, Process, and Purpose. *Am Stat*. 2016;70(2):129-133. doi:10.1080/00031305.2016.1154108
22. Howard C, Johnson DW, Morton J, Michaelis S, Supplee D, Burdon J. Is a Cumulative Exposure to a Background Aerosol of Nanoparticles Part of the Causal Mechanism of Aerotoxic Syndrome ? *Nanomedicine Nanosci Res*. 2018;139(1). doi:10.29011/JNAN-139.
23. National Academies of Sciences. *Application of Systematic Review*

Methods in an Overall Strategy for Evaluating Low-Dose Toxicity from Endocrine Active Chemicals. Washington DC: National Academies Press (US); 2017.

24. Vandenberg LN, Agerstrand M, Beronius A, et al. A proposed framework for the systematic review and integrated assessment (SYRINA) of endocrine disrupting chemicals. *Environ Health.* 2016;15(1):74. doi:10.1186/s12940-016-0156-6

25. Weisskopf MG, Kioumourtzoglou M-A, Roberts AL. Air Pollution and Autism Spectrum Disorders: Causal or Confounded? *Curr Environ Heal reports.* 2015;2(4):430-439. doi:10.1007/s40572-015-0073-9

26. Street J, Duszynski K, Krawczyk S, Braunack-Mayer A. The use of citizens' juries in health policy decision-making: a systematic review. *Soc Sci Med.* 2014;109:1-9. doi:10.1016/j.socscimed.2014.03.005

Progress Report: Diagnostics of Health Disorders and Bio Monitoring in Aircraft Crew Members after “Fume Events”— Preliminary Results After Analyzing Patient Files

Astrid Rita Regina Heutelbeck

Friedrich-Schiller-University of Jena, Jena, Germany

Corresponding author:

Astrid Rita Regina Heutelbeck
aheutel@gwdg.de

ABBREVIATIONS

AchE	Acetylcholinesterase
FE	Fume event
HBM	Human biomonitoring
NTE	Neuropathy target esterase
OP	Organophosphates
OPIDN	Organophosphate induced delayed neuropathy
TCP	Tricresyl phosphate
VOC	Volatile organic compounds

ABSTRACT

From 2014 to 2017 patients suffering from complex symptoms after fume events attended our University clinic. The patients' files contain the clinical results from external clinics, from various UMG's departments (occupational medicine, neuropathology, neurological clinic, eye clinic) as well as the results of human biomonitoring (HBM) which were applied, taking individual complaints into account. We underline the health impairment in the context of cabin air fume events and the necessity for further independent studies for analytical and clinical pathways. Evaluation of the clinical symptoms, the causing substances and the relevant contextual factors are required.

INTRODUCTION

Crew members and passengers complain regularly about health disorders after flights. In a current report, the German Federal Bureau of Aircraft Accident Investigation

defines fume events as “any incident associated with smells, smoke or mist inside an airplane as well as impairments to the health of occupants”.¹ Regarding the scientific knowledge this topic is not new. Cabin air incidents or so-called “fume events” (FE) have been associated with various symptoms among affected persons and were already mentioned in the 1950s.

In the following period similar reports underlined repeatedly that the symptoms correlated with an FE, but neither the results collected, nor systematical investigations made over many years, nor the source of the possible contamination with unknown substances during flight, nor the measurements of clinical symptoms have been effective to provoke prevention strategies.

From 2014 to 2017 patients suffering from complex symptoms after fume events attended the University for Medicine of Göttingen's (UMG), occupational clinic'. The patients' files also contain the clinical results from external clinicians (especially of the Institute for Occupation & Maritime Medicine, Translational Toxicology & Immunology Unit of the University Medical Center Hamburg-Eppendorf, Occupational Medicine Charité, Berlin, Pneumologie am Elisenhof, München, Institute for Occupational, Social and Environmental Medicine of the Friedrich Alexander University (FAU) Erlangen-Nürnberg) as well as from various of UMG's departments (occupational medicine, neuropathology, neurological clinic, eye clinic) which were applied, taking individual complaints into account. Furthermore, the results of clinical function tests and the screening for harmful substances (human biomonitoring) were documented in the patients' files.

Human biomonitoring

Human biomonitoring (HBM) is the investigation of biological material from employees for the determination of hazardous substances, their metabolites, or their biochemical or biological effect parameters. The aim of HBM is to record the exposure and health hazards of workers, to compare the analytical values obtained with appropriate assessment values and to propose appropriate measures to reduce exposure and health

hazards. The findings from HBM can be an important source of information for risk assessment and for the assessment of the effectiveness of existing occupational health and safety measures. German regulations (“Arbeitsmedizinische Regel 6.2 Biomonitoring”) state: *“Biomonitoring is useful even after accidental exposures, especially if no results from air measurements are available. Attention should be paid to a situation-appropriate assessment; the assessment results aimed at chronic effects cannot be used directly”*.

In dependence of a diagnostic time slot—the time slot after a Fume Event (FE)—blood and/or urine samples were screened for internal exposure to organophosphates (OP) and/or various volatile organic compounds (VOC).

OPs are described as a likely cause of symptoms after a fume event. Substances which inhibit the acetylcholinesterase (ACHE) or the neuropathy target esterase (NTE) are, e.g., OPs which are used among other substances as flame retardants.

Schindler *et al.* described an occupational exposure of aircrews to tricresyl phosphate (TCP) isomers and organophosphate flame retardants after fume events.² Liyasova *et al.* and Solbu *et al.* described exposure to tri-*o*-cresyl phosphate in jet airplane passengers.^{3,4} Abou-Donia *et al.* detected autoantibodies to nervous system-specific proteins in sera of flight crew members: biomarkers for the nervous system.⁵ Well-described syndromes of OP toxicity are cholinergic neurotoxicity and—for some, but not all members of this group of chemicals—the organophosphorus ester-induced delayed neuropathy.⁶

Organophosphate induced delayed neuropathy (OPIDN) involves the distal degeneration of axons of the peripheral and central nervous systems developing one to four weeks after single or short-term exposures. Characteristic signs include cramping muscle pain in the lower limbs, distal numbness and paresthesia. Known sequelae include progressive weakness and depression of deep tendon reflexes in the lower and, in severe cases,

upper limbs.^{5,7}

To be used as a biochemical effect marker in human biomonitoring studies it is important that the AChE activity in the erythrocytes of a patients’ blood sample correlates with the activity in the neurons, the target tissue of toxicity. Moreover, after reaction to organophosphates, the esteratic activity is mainly recovered after new synthesis within a period of, probably, several weeks.

Likewise, the NTE activity in the nervous tissue is correlated with the one in lymphocytes isolated from a human blood sample. Lymphocytic NTE has a regeneration half-life of probably five to seven days, enabling a sample collection after potential exposure. For the evaluation of data sets involving both enzyme activities of a single patient, it is noteworthy that there is no connection between AChE inhibition and NTE inhibition.⁶

METHODS

In the patients’ files, HBM results analyzing the erythrocytic AChE activities using the ChE check mobile® kit are described. Preliminary results described patients’ AChE activities as normal.⁸

In the patients’ files, HBM results concerning the NTE activity described preliminary low levels.⁸

So far, along with the HBM for OPs, HBM for volatile organic compounds (VOC) are described in the patients’ files. Internal exposure patterns to components (aliphatics, aromatics, ketones, alcohols) are described immediately after an FE. Special attention is given to the control values after non-exposure periods: the individual VOC concentrations after an FE showed a hundredfold increase compared to those after a flightfree period, especially concerning substances such as e.g. octane or hexane. Most of the detectable substances are not components of the general environment but are described as components of, e.g., kerosene, jet engine oil or hydraulic fluid, and are not comparable to everyday

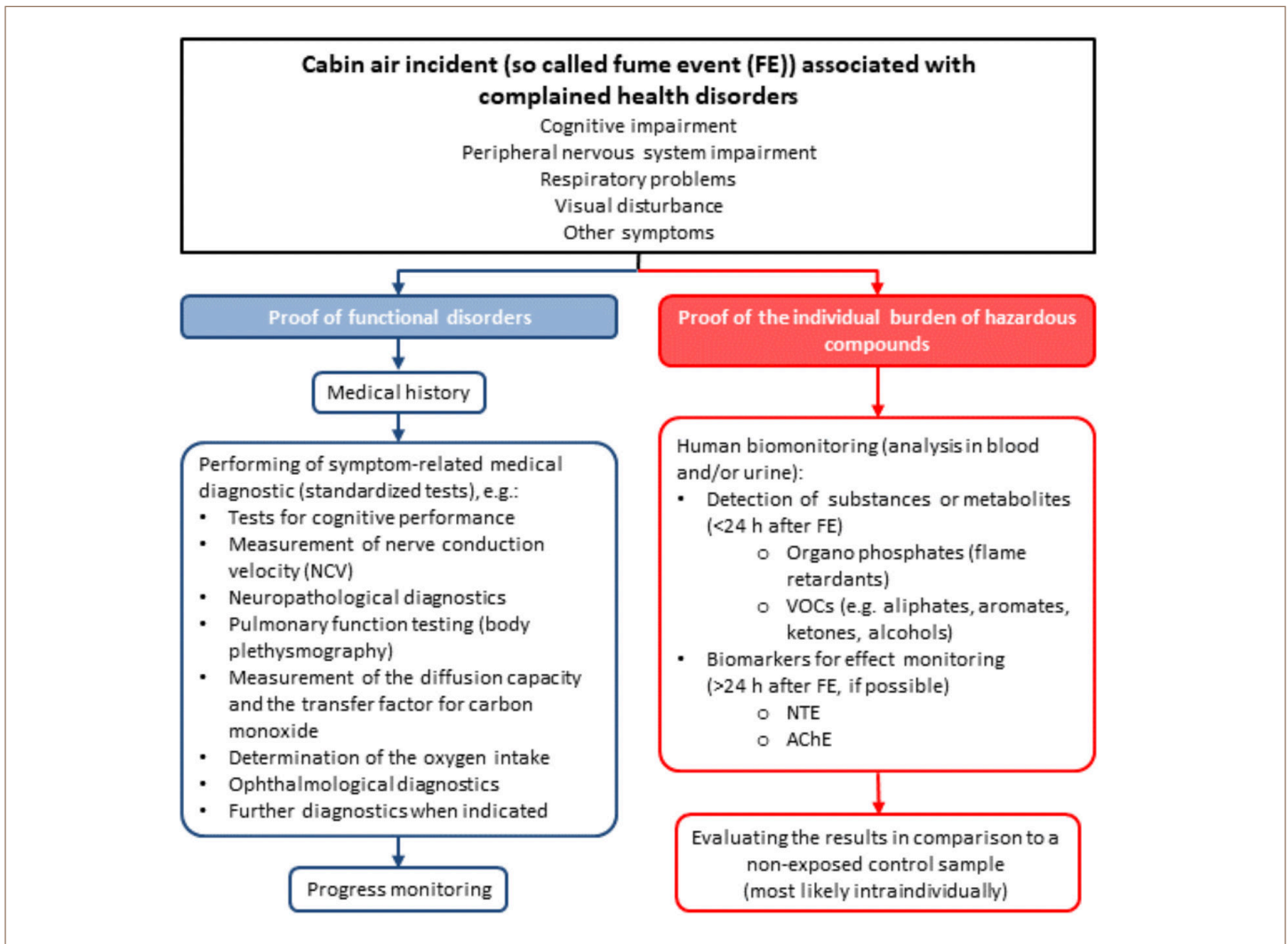

Figure 1 – Protocol of diagnostic tools based on the panel of standardized symptoms-related diagnostic methods, with noticeable findings in patients reporting symptoms after fume events (FE).

products in the general environment. In contrast to air monitoring HBM reflects the individual load of hazards from VOCs or OP levels in symptomatic patients after a fume event (FE).

Symptom and function tests

Concerning the symptoms documented in the patients' files, various complaints were found comparable with those described in detail from other working groups, in detail respiratory problems, peripheral nervous

symptoms as well as central nervous problems such as memory problems and other cognitive complaints.

Pulmonary symptoms

The preliminary results of lung function measurements documented in the patients' files – performed in accordance to international standard (ERS/ATS standards for single-breath carbon monoxide uptake in the lung) – showed a percentage distribution of the FEV1 and VC comparable to the healthy norm population.

We can conclude that the breathing mechanism seems to be mostly undisturbed, however, the patients are symptomatic.

Therefore, we take a look at further lung function parameters concerning the oxygen intake: in symptomatic patients after an FE a shift of the distribution, compared to those of the healthy norm population, could be observed: most values were found notably under the mean value, in most of the cases the reduction shows several standard deviations compared to those of the healthy norm population. Statistical validation of the diffusing capacity of the lung for carbon monoxide (DLCO), 5% of the general population were defined as expected “not healthy”, this corresponds to Z-Score -1,645: regarding the symptomatic patients after an FE, more than 50% showed values under this point. Comparing results from different clinics it should be noted that the inter- or intra-laboratory accuracy is described as diverse due to different device types for measuring DLCO.⁹ Additionally, a measurement of the nitric oxide uptake in the lung, a relative reduction of the microvascular (VC) components compared to the membrane (DM) component can be observed. Further studies are needed to define the relative response between diffusing capacity of the lung for nitric oxide (DLNO) and DLCO under a range of perturbations such as exercise and high-altitude exposure as given during flight for crew members; these comparisons could yield mechanistic insight into alveolar microvascular recruitment.¹⁰ The results are proven by performing a bicycle-based exercise stress test detecting respiratory gases under stress. However, the irregularity of these parameters corresponds to the patients’ complaints of breathlessness under stress.

Cognitive impairment

Another symptom complex includes cognitive impairment, in particular difficulties of speaking and finding of words, memory performance, concentration problems and/or incoordination. The interim analytical findings show that about 80% of the patients struggle with symptoms of cognitive impairment and confirm one or more symptoms in most cases, specifically cognitive

impairment. This is in accordance with the results which are described from other working groups.

Peripheral nerve impairment

The patents’ files contain the evaluation of diagnostics or peripheral nervous complaints (restless legs, muscular jerking, tingling sensations), in particular, peripheral nerve function measurement and neuropathological investigation. The results of the neurography were frequently unremarkable despite credible similar patterns of complaints amongst patients. Performing standardized neuropathological diagnostics to look for a special kind of neuropathy,¹¹ so-called small fiber neuropathy which is characterized by a reduced density of epidermal nerve fibers. Our preliminary results: in nearly all patients the intra-epidermal nerve fiber showed significantly decreased densities and as such clearly under the mean value of the healthy norm population. Normally this kind of neuropathy can be detected as a long-term effect in patients with diabetes, alcoholism or after some infection such as borreliosis.

CONCLUSIONS

However, despite all of these clear findings of functional disorders, there are still many questions open concerning the diagnostic pathways of other symptoms such as cardiovascular symptoms, especially due to the findings of post-mortem reports (e.g. myocarditis), gastrointestinal symptoms, visual organ, and others.

The symptoms in patients exposed to fume events show similar patterns including various organ systems, in particular, the central and peripheral nervous system, the lung, the visual organ, the gastrointestinal tract. These symptoms can be confirmed using standardized diagnostic tests especially neurocognitive tests, monitoring the oxygen intake and neuro-histological tests. The clinical findings are conclusive in the context of the descriptions of the toxicological potential of the detected VOCs and organophosphates, for instance concerning OPIDN. Figure 1 outlines the Protocol of diagnostic tools based on the panel of standardized symptoms-related diagnostic methods with noticeable

findings in patients reporting symptoms after fume events (FE).

HBM is regarded as the method of choice in accordance with the German regulations (e.g. the “Arbeitsmedizinische Regel 6.2 Biomonitoring”) taking into account different substances which are described as components of kerosene, hydraulic fluid and/or oil, in particular OP or VOCs.

Special attention was given to the internal exposure pattern: most of the detectable substances are not components from within the general environment, but as mentioned above, components of e.g. kerosene, jet engine oil or hydraulic fluids.

Summarizing our experience regarding the patients’ files, we underline the health impairment in the context of cabin air fume events and the necessity for further independent studies for analytical and clinical pathways. Evaluation of the clinical symptoms, the causing substances and the relevant contextual factors is required. More evidence for appropriating diagnostic algorithm, appropriating therapeutic algorithm and appropriating evidence-based systematic risk assessment for good workplace safety and effective preventive measures is needed. In the long run, the aim has to be the completion of an optimal patient care strategy for therapy and rehabilitation, and prevention strategies. With reference to the last mentioned points, there is to date no evidence-based knowledge, even though fume events have been described for several decades.

Acknowledgments

Special thanks to Lygia Budnik, Xaver Baur, Frank Powitz, Christine Stadelmann, Walter Paulus, Alexander Augsten, Naomi Mohr, Cathrine Bornemann, Anke Seeckts, Martina Lange, Michael Müller, and Ernst Hallier for performing the function tests, human biomonitoring and/or supporting the analysis of the patients’ files.

References

1. BFU. *BFU 803.1-14. Study Of Reported Occurrences In Conjunction With Cabin Air Quality In Transport Aircraft*. Braunschweig: Bundesstelle für Flugunfalluntersuchung; 2014.
2. Schindler BK, Weiss T, Schütze A, et al. Occupational exposure of air crews to tricresyl phosphate isomers and organophosphate flame retardants after fume events. *Arch Toxicol*. 2013. doi:10.1007/s00204-012-0978-0.
3. Liyasova M, Li B, Schopfer LM, et al. Exposure to tri-o-cresyl phosphate detected in jet airplane passengers. *Toxicol Appl Pharmacol*. 2011;256(3):337-347. doi:10.1016/j.taap.2011.06.016.
4. Solbu K, Daae H, Olsen R et al. Organophosphates In Aircraft Cabin And Cockpit Air-Method Development And Measurements Of Contaminants. *J Env Monit*. 2011;13(5):1393-1403.
5. Abou-Donia MB, Abou-Donia MM, ElMasry E et al. Autoantibodies To Nervous System-Specific Proteins Are Elevated In Sera Of Flight Crew Members: Biomarkers For Nervous System Injury. *J Toxicol Env Heal A*. 2013;76(6):363-380.
6. Lewalter J, Leng G, Röhrig B. Neuropathy target esterase (NTE) [Biomonitoring Methods, 2007]. *MAK Collection Occup Heal Saf*. January 2012. doi:doi:10.1002/3527600418.bi0nteleue0011.
7. Lotti M, Moretto A. Organophosphate-induced delayed polyneuropathy. *Toxicol Rev*. 2005;24(1):37-49. doi:10.2165/00139709-200524010-00003.
8. Heutelbeck ARR, Bornemann C, Lange M, Seeckts A, Müller MM. Acetylcholinesterase and neuropathy target esterase activities in 11 cases of symptomatic flight crew members after fume events. *J Toxicol Environ Heal Part A*. 2016;79(22-23):1050-1056. doi:10.1080/15287394.2016.1219561.
9. Jensen R, Leyk M, Crapo R, Muchmore D, Berclaz PY. Quality control of DL_{CO} instruments in global clinical trials. *Eur Respir J*. 2009;33(4):828-834. doi:10.1183/09031936.00091208.
10. Zavorsky GS, Hsia CCW, Hughes JMB, et al. Standardisation and application of the single-breath determination of nitric oxide uptake in the lung. *Eur Respir J*. 2017;49(2). doi:10.1183/13993003.00962-2016.
11. Lauria G, Hsieh ST, Johansson O, et al. European Federation of Neurological Societies/Peripheral Nerve Society Guideline on the use of skin biopsy in the diagnosis of small fiber neuropathy. Report of a joint task force of the European Federation of Neurological Societies and the Peripheral Ne. *Eur J Neurol*. 2010;17(7):903-912, e44-9. doi:10.1111/j.1468-1331.2010.03023.x.

Pathogenesis of Non-Specific Neurological Signs and Symptoms in Aircrew on Civil Aircraft

C. Vyvyan Howard

Centre for Molecular Biosciences, University of Ulster, Coleraine, Northern Ireland

Corresponding author:
C. Vyvyan Howard
vyv.howard@googlemail.com

KEYWORDS

central nervous system, organo-phosphate, aerotoxic syndrome, emissions, bleed air

ABBREVIATIONS

CNS Central nervous system
OP Organophosphate

ABSTRACT

This paper addresses the basic neurobiology which leads to the brain being a 'target organ' for chronic low dose organo-phosphate toxicity. This includes the irreplaceability of nerve cells, the logistic problems neurons have in serving axons (that in some neurons can be over one meter long), the dependence of neurons on neurotrophins, and the vulnerability of neurons to damage through impairment of axonal transport.

INTRODUCTION

The central nervous system (CNS) is particularly vulnerable to toxic insult for a number of reasons. The nerve cells that are a component of the adult brain have to last a lifetime. Many other organs in the body, for example the liver, can repair by cell proliferation. This does not apply to the nerve cells in the CNS (Figure 1). The brain has a very high metabolic rate and neurons have to maintain their microstructures over long distances. For example, the axon, which carries outgoing signals from the neuron, can be over 1 meter

long. To maintain such structures in a healthy state there is a mechanism called 'axonal transport' which will deliver a number of substances and structures in both directions to and from the neuron cell body. Transmitter substances help to deliver information across synapses to the next neurons in the neuronal chain. Neurotrophins are also secreted across the synapse and are essential to maintain the target neurons in good health. Mitochondria are the 'powerhouses' in which glucose is metabolized and maintain the high metabolic rate essential for neuronal health, even in the most distant parts of the nerve cell.

The reaction of the CNS to toxic insult is variable. High dose acute toxicity will cause acute toxic damage. However, repeated low dose exposure to neurotoxic substances can cause sub-acute chronic toxicity over a long period of time.¹ This is true of organo-phosphate (OP) compounds. Nerve gas OP compounds (eg. sarin, VX) can cause acute death by attacking the enzyme anticholinesterase. However, of much more relevance to the etiology of aerotoxic syndrome, chronic low dose exposure to OPs at levels well below any cholinergic symptoms can cause neurotoxic effects. Terry has reviewed this topic and shown that axonal transport can be affected by repeated low dose OP exposure.² This would interfere with the delivery of transmitter substances, neurotrophins and mitochondria to target neurons and could be the basis of the development of a diffuse subacute encephalopathy.³

The existing literature on low dose repeated exposure to OP compounds was analyzed with respect to medical problems being reported amongst aircrew, concentrating on non-cholinesterase mechanisms at levels of exposure that produce no overt signs of acute toxicity.⁴ These include covalent binding of OPs to tyrosine and lysine residues, which suggests that numerous proteins can be irreversibly modified by OPs. In addition, the mechanisms of oxidative stress and neuro-inflammation and the known OP targets of motor proteins, neuronal cytoskeleton, axonal transport, neurotrophins and mitochondria are of importance in the pathogenesis pathway.

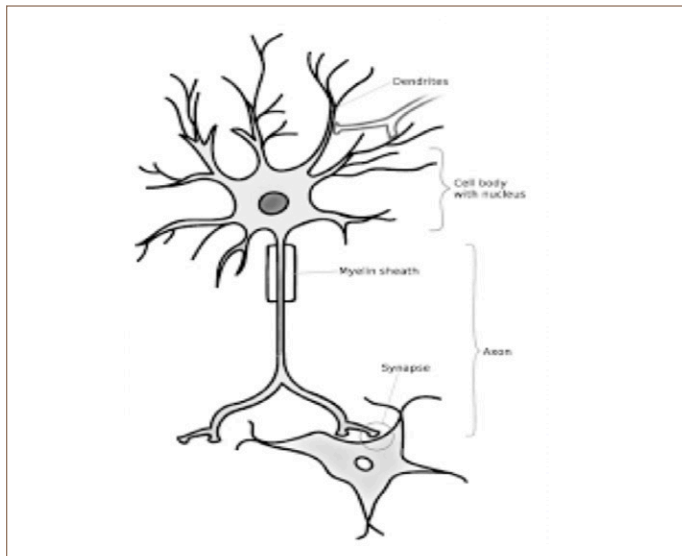

Figure 1— Schematic diagram of a neuron showing the soma (cell body), dendritic arbor and efferent axon communicating with the subsequent neuron in the information chain. The axon has to maintain the health and normal functioning of the axon and its telodendria (terminal branching), often over long distances of up to 1 meter. This is achieved by the mechanism of axonal transport which works in both directions (anterograde and retrograde). Another important function is the maintenance of the health of target neurons through the secretion of neurotrophins.

References

1. Harris J, Blain P. *Neurotoxicology: What the Neurologist Needs to Know: Journal of Neurology, Neurosurgery, Psychiatry, 2004; 75 (Suppl iii; P iii29-iii34) CEN TC 436 N206.*; 2018.
2. Terry AJ. Functional Consequences of Repeated Organophosphate Exposure: Potential Non-Cholinergic Mechanisms. *Pharmacol Ther NIH Public Access.* 2012;134(3):355-365. doi:10.1038/jid.2014.371
3. Howard C V. The Aetiology of “Aerotoxic Syndrome”- A Toxicopathological Viewpoint. *Open Access J Toxicol.* 2017;1(5):1-3. doi:10.19080/oajt.2017.01.555575
4. Michaelis S, Burdon J, Howard C. Aerotoxic Syndrome : a New Occupational Disease ? *Public Heal Panor.* 2017;3(2):198-211.
5. Howard C V, Johnson DW, Morton J, Michaelis S, Supplee D, Burdon J. Is a Cumulative Exposure to a Background Aerosol of Nanoparticles Part of the Causal Mechanism of Aerotoxic Syndrome ? *Nanomedicine Nanosci Res.* 2018;139(1). doi:10.29011/JNAN-139.

The nature of exposure to fugitive emissions from gas turbine engine bleed air to the concept of ‘dose’ when dealing with irreversible molecular processes was discussed, particularly with respect to the extended periods of exposure experienced by aircrew over a working lifetime. Additionally, the toxicology of complex mixtures was addressed and the potential effects of the continual presence of ultrafine particles in engine bleed air was considered.⁵

The overall conclusion is that a toxicological mechanism consistent with the reported symptomatology of aircrew complaining of ill health associated with cabin air quality exists. Repeated low dose exposure to a complex mixture of neurotoxic substances in engine bleed air needs to be much more seriously considered.

Lubricant and Lubricant Additive Degradation: Implications for Cabin Air Quality

David W. Johnson

University of Dayton, Dayton, USA

Corresponding author:
David W. Johnson
djohnson1@udayton.edu

KEYWORDS

air quality, lubricant, seals, phosphate esters

ABSTRACT

The composition and decomposition chemistry of the lubricants used in commercial aircraft was described. The common reactions of ester base stocks include hydrolysis and oxidation which results in the formation of aldehydes, anhydrides and a new set of organic acids. This explains why there is an increase in the number of compounds in the lubricant upon use. The chemistry of phosphate ester additives was also described along with the reasons for their continued use. High temperatures can result in isomerization of the cresol along with hydrolysis and addition reactions leading to a wide range of phosphate ester products. The implications of lubricant degradation on cabin air quality is also considered.

INTRODUCTION

Lubricants serve a number of purposes, including the reduction of friction, the reduction of wear and the removal of heat from bearings. The oil is normally held in place by various types of seals, but even the best designed seals will leak a small amount of the lubricant. Cabin air for most commercial airliners is drawn from the compressor stage of the engine and fed directly into the aircraft cabin. This air normally contains small amounts of the leaked lubricant and its decomposition products, and in the case of seal failure, much larger amounts of decomposed lubricant. The composition of the used

lubricant and the pathways for its degradation will be investigated in the paper.

Lubricant specifications

Lubricants used in commercial airliners all are required to meet specification AS5780C,¹ which specifies the properties of the lubricant, but not the composition. The performance specification means that while all oils have similar properties and are generally compatible, the composition of the different oils can vary. The performance specification limits the oils to synthetic esters, which require both antioxidants to improve the stability of the oil and phosphate esters to improve the lubricating properties and reduce engine wear. The specifications also limit the reactivity of the oil, but most testing is done at the bulk oil temperature limit and not the higher temperatures experienced within the engine.

Lubricant composition

Modern aerospace lubricants are made from a synthetic ester base stock. The esters are based on a highly hindered alcohol that reacts with various carboxylic acids to form esters as is seen in Figure 1. The use of various carboxylic acids enable fine tuning of properties such as pour point, flash point, viscosity and viscosity index. The use of mixtures of acids and alcohols is preferred because it provides for a wider liquid temperature range and allows for a better combination of physical and chemical properties. A typical lubricant, analyzed by gas chromatography/mass spectrometry (GC-MS), is shown in Figure 2.

While ester-based lubricants have excellent physical and chemical properties, additives are used to reduce oxidation and reduce bearing wear.

Lubricant additives

Lubricants, in order to meet the specifications typically require a number of additives to reduce the reactivity of the oil and modify other properties. The additives typically include antioxidants, metal ion deactivators and anti-wear of extreme pressure additives.

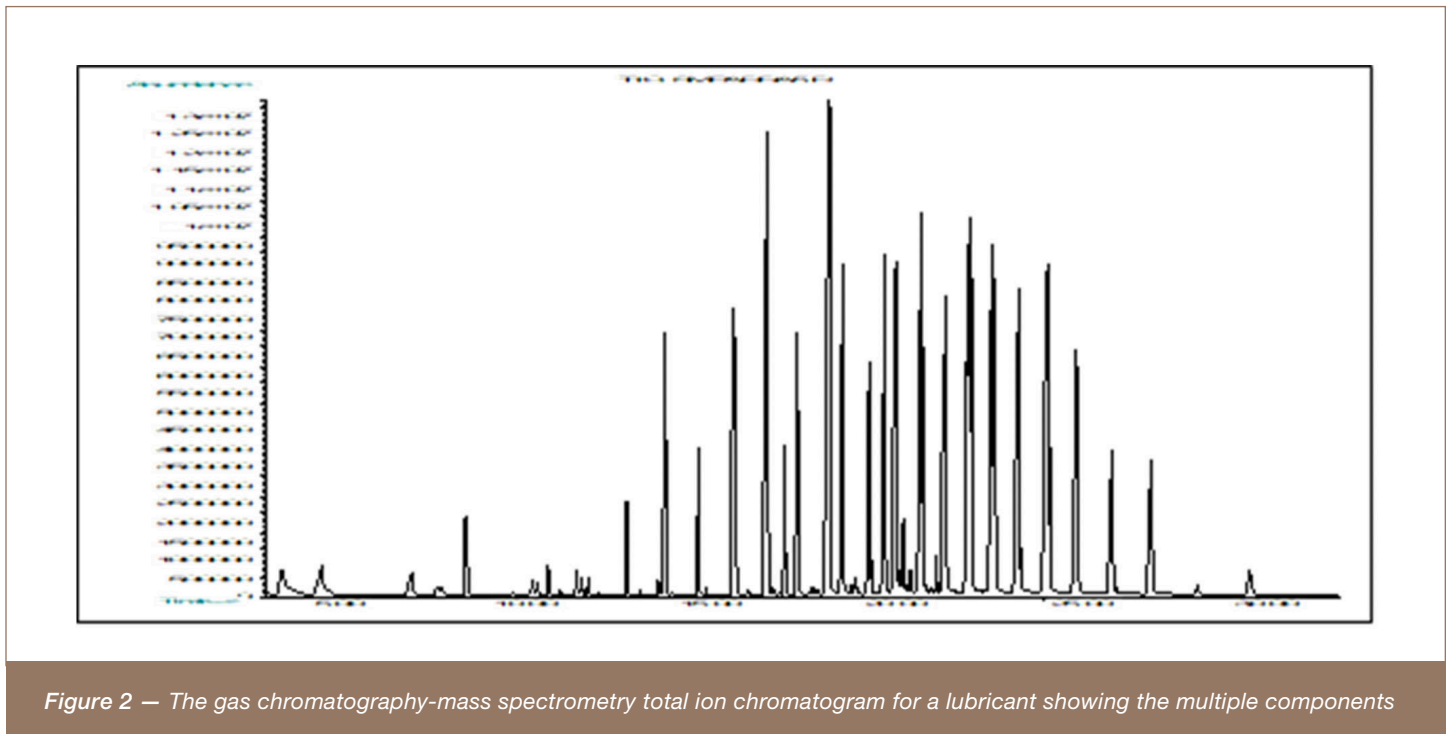
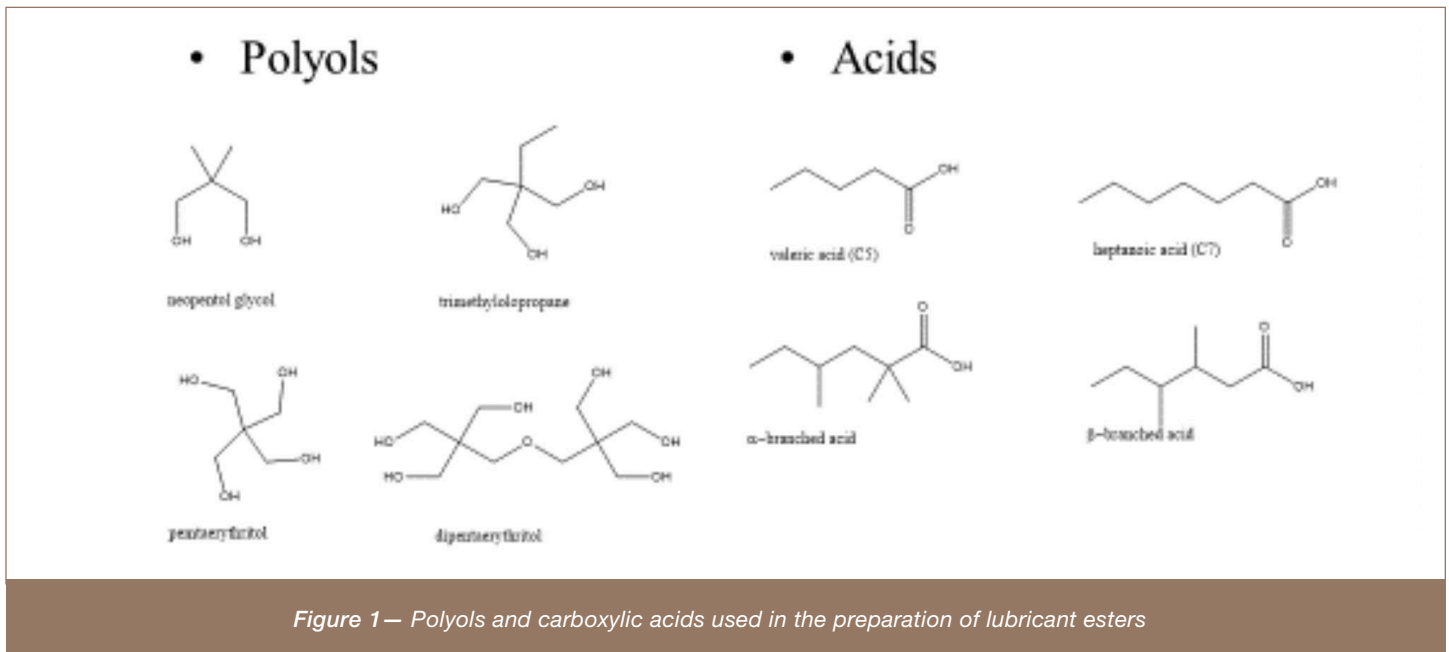

$$P = \left(\left(\frac{\gamma - \varepsilon \sin \gamma}{(1 - \varepsilon^2)^{3/2}} \right) - \left(\frac{\gamma - 2\varepsilon \sin \gamma + \varepsilon^2 \gamma / 2 + (\varepsilon^2 \sin 2\gamma) / 4}{(1 - \varepsilon \cos \gamma)^{3/2} (1 - \varepsilon^2)^{3/2}} \right) \right) (6U\eta R/c)$$

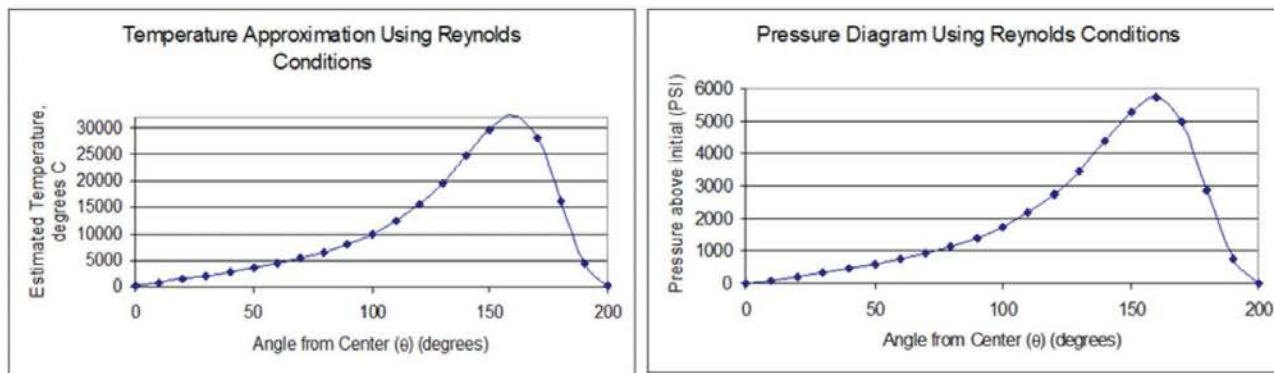

Figure 3 – Pressure and temperature conditions predicted using the Reynolds equation

Antioxidants

Antioxidants are added as a way to reduce oxidation reactions of the base stock. They typically act by reacting with free radicals such as the hydroperoxy radical that is formed by reaction of organic compounds with oxygen. For aerospace applications, amine antioxidants are typically used. Among the most common are N-phenyl-1-naphthylamine (PANA) and 4,4'-diocetylphenyl amine (DODPA).

Anti-wear/Extreme Pressure

Anti-wear and extreme pressure additives reduce friction and wear by forming a hard and slippery surface on the bearing. Typically, phosphorus and sulfur compounds form the appropriate coating. The use of sulfur compounds would be unacceptable due to the odor associated with them and the use of bleed air for cabin pressurization. That leaves the only effective option as the phosphate esters.

Metal deactivators

Metal atom deactivators are compounds that react to stabilize metal ions that end up dissolved in the lubricant.

These are typically benzotriazole or chelating Schiff bases.

Degradation conditions

Lubricants in turbine engines are exposed to a wide range of conditions, from very low external temperatures, to bulk oil temperatures recorded for the oil, to even hotter engine parts and the extreme conditions of temperature and pressure in the contact regions within bearings. The range of temperature that the lubricant might experience for long periods of time are established in the specifications as the pour point and flash point temperature. In addition, oxidative corrosion testing is conducted at the highest bulk oil temperature for the oil. Lubricants are likely to experience substantially higher temperatures for short periods within the engine. Engine temperatures are typically about 500°C. Contact with engine parts as high as 1700°C are also possible within the engine.²

A more difficult question to answer is the stress on the lubricant that is generated within the contact regions of the bearing. The Reynolds equation allows estimates of these temperature and pressure conditions. The

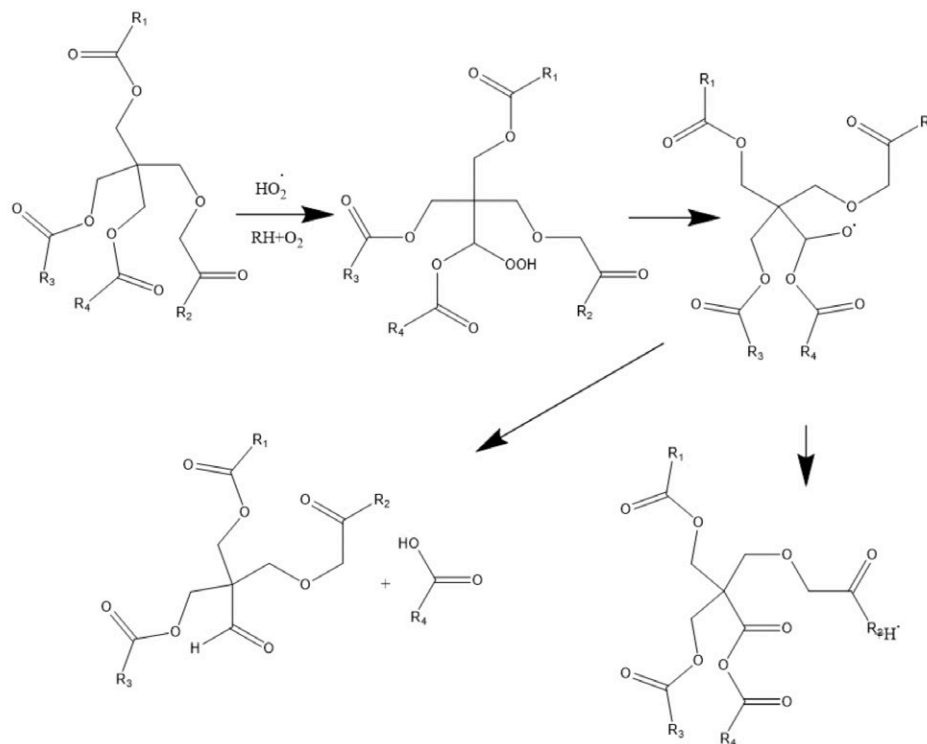

Figure 4 – Thermal oxidative decomposition of lubricant base stocks

Reynolds equation and the pressures and temperatures predicted are shown in Figure 3.³

Lubricant base stock degradation

Ester based lubricant base stocks have several low and moderate temperature degradation routes. Probably the simplest route would be through hydrolysis. This route is possible due to the roughly 500 ppm solubility of water in the base stock. Further evidence of this route is the presence of acids and partial esters from the base stock in the GC-MS of most oil samples.

A second common reaction of the base stock is the oxidation of the base stock with molecular oxygen. This reaction which is thought to proceed through a radical mechanism involving the abstraction of a hydrogen atom to form the hydroperoxy radical, yields acids, aldehydes, ketones and anhydrides as is shown in Figure 4.

At higher temperatures a wide range of reactions can occur. The pyrolysis of a lubricant at 350°C yields a complex mixture that shows at least 634 distinct peaks, of which 170 were identified.⁴ Among the compounds that were identified include acids, aldehydes, ketones, phosphate esters and polycyclic aromatic compounds. It is likely that the latter two groups are a result of the additives and not the base stock. At higher temperature more complex mixtures with a wider range of compounds might be expected to be formed. It was also observed in a separate study that carbon monoxide is formed at levels up to 150 ppm.⁵

Phosphate ester degradation

Throughout this conference there has been a discussion of the health problems phosphate esters cause, raising the question, why are they still in use. Phosphate esters, primarily triaryl phosphates are added to improve the

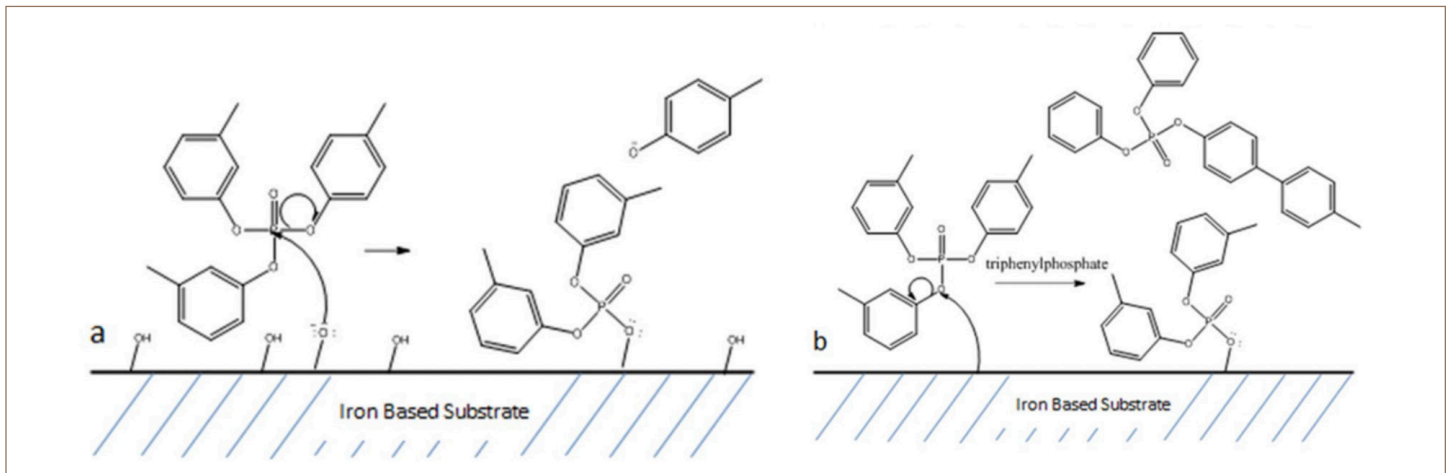

Figure 5 — Reactions of triaryl phosphate at the surface of a metal

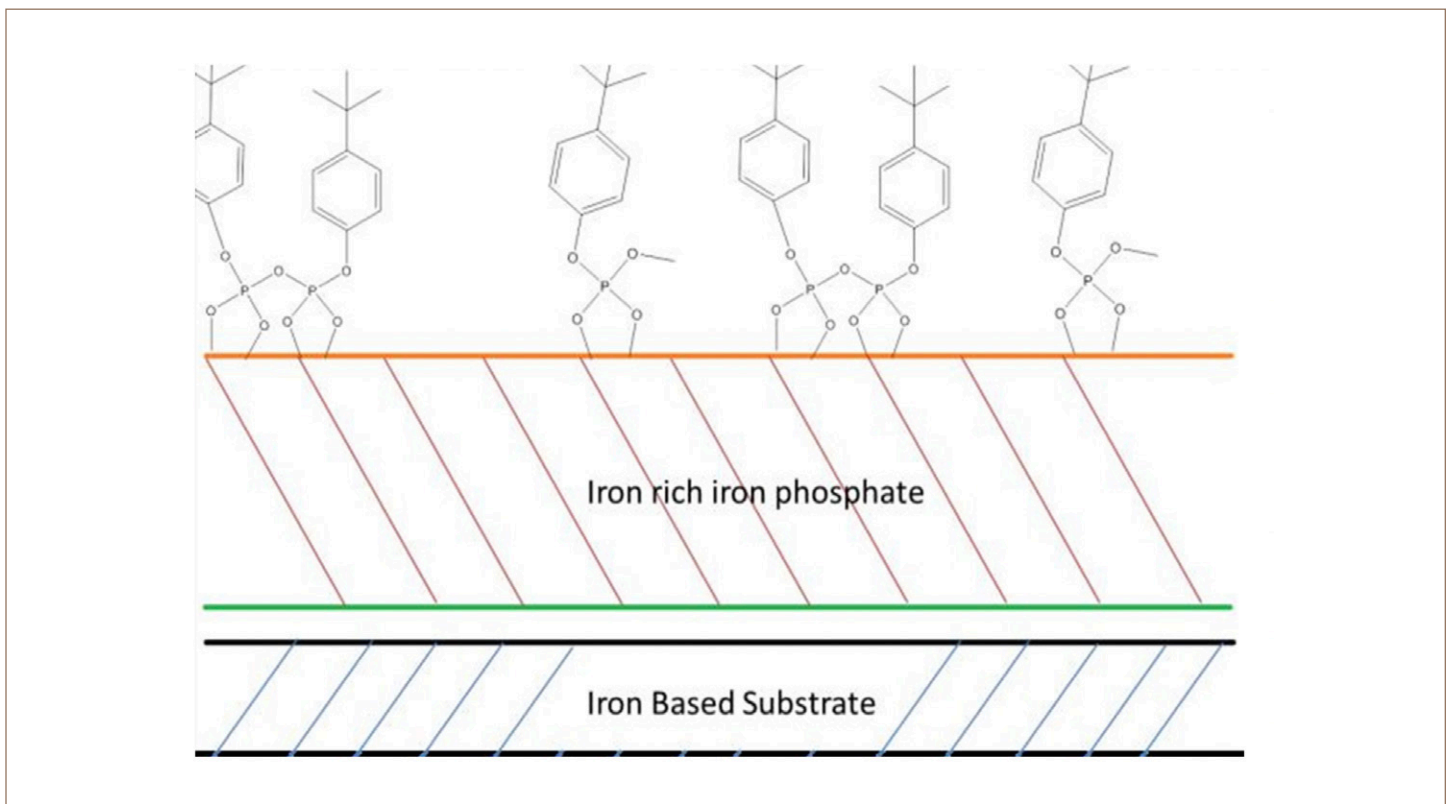

Figure 6 — Formation of a solid lubricious film from the iron surface and phosphate ester

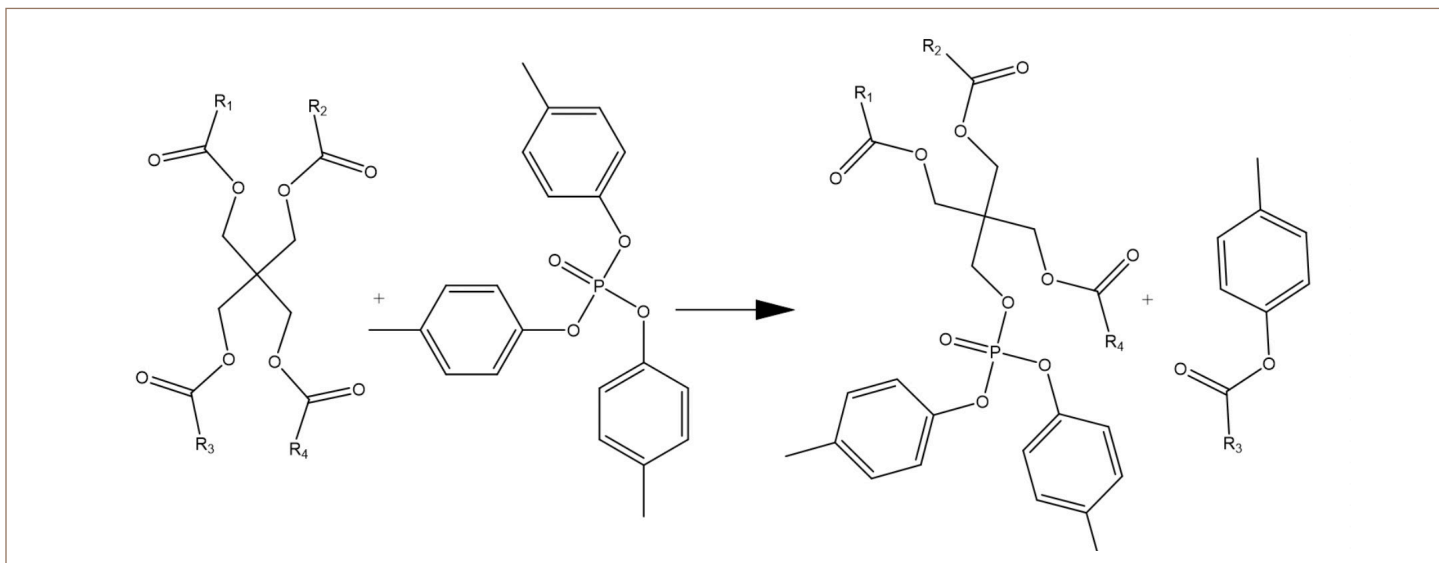

Figure 7 — Transesterification of a base stock polyol ester with a phosphate ester

extreme pressure performance of the polyol ester basestock. The phosphate esters bind to bearing surfaces forming a film that lubricates the bearing during startup and also under conditions of extreme stress, reducing the possibility of catastrophic failure.

Phosphate esters are known to chemically bond to the surface of bearings forming a lubricious film. The initial reaction of the phosphate can proceed in two ways depending on the degree of oxidation of the surface at that point as is shown in Figure 5. In the case of an oxidized surface, cresol is released and the phosphate is bound to the surface. If there is limited oxygen present the aromatic ring is transferred to another molecule and a bound phosphate is again the result.⁶

After the initial reaction of the phosphate with the metal surface, the reaction can continue releasing the alcohols leaving a polyphosphate at the surface of the bearing. Under conditions of wear, the coating wears away, but is reformed by reaction with the lubricant additive, leaving the bearing protected. The surface film is shown in Figure 6.

Phosphate esters react in a number of ways at temperatures of 400-500°C. One of the reactions allows for the isomerization of various groups on the aromatic ring. This reaction can be a particular problem due to the known neurotoxicity of *ortho* Tricresyl phosphate (TCP) isomers. Even though modern TCP is free of the *ortho* isomers, isomerization causes the formation of small amounts of the *ortho* isomer under conditions found in turbine engines.

Other reactions that have been observed at temperature near the operating temperature of the engine are transesterification reactions between the lubricant and the phosphate ester. In transesterification, the alcohols and acids of two esters change partners as is shown in Figure 7. Transesterification can result in a whole new class of potentially toxic compounds within the oil.

CONCLUSIONS

The chemistry of the lubricant base stock generates a wide range of compounds that are expected to be present in cabin air at low levels under normal

circumstances. While the toxicology of some compounds is known on an individual basis, the inhalation toxicity of highly complex mixture, including the aerosols associated with smoke is not understood. Given all of these uncertainties, the use of unfiltered bleed air for pressurization presents an unacceptable risk to both passengers and crew.

References

1. MIL-PRF-23699G, *Performance Specification: Lubricating Oil, Aircraft Turbine Engine, Synthetic Base, NATO Code Numbers: O-152, O-154, O-156, and O-167 (13-MAR-2014) 23699 Specs. 2014. Available from: <http://everyspec.com/MIL-PRF/MIL-PRF-010000-29999/MIL-P.>; 2014.*
2. Johnson DW. Lubricants for Turbine Engines. In: *Recent Progress in Some Aircraft Technologies*. INTECH; 2016:35-53. doi:<http://dx.doi.org/10.5772/62394>
3. Hills, J E. Decomposition of Polyol Ester Lubricants Containing Tricresyl Phosphate in the Presence of Metal Carbides: ". M.S. Thesis. 2009.
4. EASA. *Research Project: AVOIL. Characterisation of the Toxicity of Aviation Turbine Engine Oils after Pyrolysis. Final Report EASA_REP_RESEA_2015_2*. Cologne: European Aviation Safety Agency; 2017. <https://www.easa.europa.eu/the-agency/procurement/calls-for-tender/easa2015hvp23>.
5. Van Netten C, Leung V. Hydraulic fluids and jet engine oil: Pyrolysis and aircraft air quality. *Arch Environ Health*. 2001;56(2):181-186. doi:10.1080/00039890109604071
6. Johnson D, Hils J, Johnson DW, Hils JE. Phosphate Esters, Thiophosphate Esters and Metal Thiophosphates as Lubricant Additives. *Lubricants*. 2013;1(4):132-148. doi:10.3390/lubricants1040132

Airline Captain's Case Study of Jet-Engine Oil Based Contaminated Cabin Air

Michael Kramer

Global Cabin Air Quality Executive, London, England

Corresponding author:
Michael Kramer
kramermichael@me.com

KEYWORDS

pilot health, air bleed, fume event, oil

ABSTRACT

This presentation shows a case study based personal experience of the author as an airline pilot. It is an overview of the cause and effect of contaminated bleed air on pilots and their acute symptoms on their cognitive capacity commandeering an aircraft after inhalation of toxic fumes and the dangers of such concerning their responsibility for the safety of passengers and crew. The materials presented causing this effect are pyrolyzed oil fumes from jet-engine oil and their ability of long-term injuries of the nervous system and a very certain but common diagnosed lung diffusion impairment after experienced fume events.

INTRODUCTION

It is shown that the inhalation of these fumes can lead to various acute, uncontrollable disorders and can also result in excessive damage due to oxidative stress to the central nervous system. This review gives details about some acute toxicity mechanisms, along with their long-term health effects.

Michael Kramer (MK) started his career as a military aircraft mechanic and later received his A/P from the Lufthansa Technical Training school. After leaving the military he worked as an aircraft mechanic and then as an engineer on executive aircraft (and engines).

He started flying as a pilot on Turboprops like Metroliner and Jetstream 31 for three years, following BAe146 for two years, then Bombardier CRJ-100 to -900 series aircraft for ten years and Airbus A300 for almost four years. In total almost 19 years of commercial aviation.

While flying the BAe146 he smelled and subsequently inhaled a lot of engine oil fumes on a regular basis, especially in the mornings after auxiliary power unit (APU) start. He never experienced a fume event with visible smoke or haze. There were some incidents when crew became incapacitated at which time he already flew the brand new Bombardier CRJ's. But by the time he left the BAe146 for the new fleet, he realized that his immune system was very low while experiencing many more sinus colds than would be the norm. In the ten years of flying CRJ's he never experienced a fume event and his health recovered. Even the lung performance reached almost 100% again. Then he changed the company and started to fly the A300-600.

After having experienced several (well documented) smell and fume events, his last flight ever took place on September 3rd 2015 with yet another fume event. He encountered several fumes or 'smell events' with engine oil or minor exposures to jet fuels, either at engine start up or shut down but he did not notice his health degrade significantly. He also gained weight with new digestion problems and developed food allergies; initially he put it down to age, the kind of job, but never toxic cabin air.

Convinced that the authorities would take proper action if there were any danger for crew and passengers he continued trusting the system. His attitude changed after his experience on his last flight with the massive exposure to pyrolyzed engine oil fumes due to broken seals, after which he developed long lasting health symptoms.

The event

They had oil smell right after take-off. As pilot in command (PIC) MK gave it a try and switched pack no. 1 'off' with the result that the smell disappeared. Upon arrival the engineer transferred it to the 'Hold Item' list

and labelled pack no. 1 'INOP'.

The second leg was a short low-level positioning flight into Heathrow and there was no oil smell. The next leg from Heathrow to Leipzig and once again oil smell appeared right after take-off. When the smell increased MK switched the remaining pack no. 2 'off' and the 'INOP' labelled pack no. 1 'on' and the smell disappeared. As they were reaching cruise level with thrust reduction the smell reappeared again and got worse. He changed pack no. 2 to 'on' and no. 1 'off' and the smell disappeared. The next 45 minutes in cruise flight were uneventful and the pilots thought all was OK.

When they started descent procedures both pilots began to feel dizzy, nauseated and strangely fatigued. The oil smell started intensifying quickly and got worse again. Passing flight level 230, MK started the APU to get a third air source, but there was no improvement of air quality, so he switched 'off' all packs and bleeds and both pilots used their oxygen masks. Although they used the oxygen masks, they did not recover sufficiently to confidently land the aircraft manually. After landing in 'auto land' MK 'forgot' to disconnect the autopilot to vacate the runway.^{1,2} During 'shut down' the First Officer mentioned that all switches were covered with a fine layer of engine oil. The arriving maintenance crew confirmed the still present smell and told the pilots that this aircraft was known to have the problem.

The technical findings aftermath brought a leakage of bearing #2 back plate carbon seal on both engines to light, due to which the environmental control system (ECS) became severely contaminated with engine oil.³⁻⁵

After arrival at the local hospital the pilots received a medical examination according to a guideline of the employers' liability insurer 'Berufsgenossenschaft Verkehr' (BG).

After being checked at this hospital where the medical staff did not exactly know what they were looking for, the First Officer recovered fully after a few days; it had been his first fume event at the age of 26.

The Captain's (MK) overall symptoms in the first week were:

- 'high' feeling for 5 days
- extreme fatigue
- extreme headaches
- sleep disorders
- metallic taste

followed by:

- lasting cognitive and neurological impairment
- lasting respiration problems with the DLCO at only 66%
- pulmonary issues with some calcified nodules in his lungs⁶
- fibrosis
- small fibre neuropathy

At the time of this presentation, almost two years later, the airline's insurer had sent a report denying that contaminated cabin air was the reason for his long-term health problems and stopped monthly compensation.

The BFU (accident investigation agency) has not released their report yet.

CONCLUSIONS

Following his experiences with the authorities and medical establishment MK has founded the organisation 'P-COC' (Patient Initiative Contaminated Cabin Air e.V.) to:

- build a network to connect everybody that is involved e.g. crewmembers, passengers, physicians, scientist, attorneys, politicians etc.

to demand:

- that all aircraft are immediately equipped with sufficient protection for crew and passengers i.e.: masks, filters etc.
- immediate information of the public about the problem of contaminated cabin air by the responsible

representatives of industry and politics, as well as a general information requirement for passengers by the airline in the case of an incident with contaminated cabin air

- the immediate implementation of all prevention measures, e.g. crew training on proper reporting, health checks etc.⁷
- the proper investigation of fume events by the Bundesstelle für Flugunfalluntersuchung (BFU) according to EU-Regulation 996/2010
- the proper handling of occupational accidents with contaminated cabin air by the BG Verkehr according to prevailing law
- the complete scientific research of all circumstances causing incidents with contaminated cabin air by using all available resources and creating additional, independent institutions to support the process.
- the continuous monitoring of the cabin air on commercial aircrafts on toxic components by using the latest technology available

6. Burdon J, Glanville A. Lung injury following hydrocarbon inhalation in BAe 146 aircrew. *J Occup Heal Saf - Aust New Zeal.* 2005;21(5):450-454. ICAO. Cir 344-AN/202. Guidelines on Education, Training And Reporting Practices Related To Fume Events. Montréal: International Civil Aviation Organization; 2015.

References

1. Abou-Donia MB, Abou-Donia MM, ElMasry E et al. Autoantibodies To Nervous System-Specific Proteins Are Elevated In Sera Of Flight Crew Members: Biomarkers For Nervous System Injury. *J Toxicol Env Heal A.* 2013;76(6):363-380.
2. Mackenzie Ross SJ, Harrison V, Madeley L, et al. Cognitive function following reported exposure to contaminated air on commercial aircraft: methodological considerations for future researchers. *J Biol Phys Chem.* 2011. doi:10.4024/30MA11A.jbpc.11.04
3. Michaelis S. Oil bearing seals and aircraft cabin air contamination. *Seal Technol.* 2016;4, April(4):7-10. doi:http://doi.org/10.1016/S1350-4789(16)30104-0
4. Winder C, Balouet JC. Aircrew Exposure to Chemicals in Aircraft : Symptoms of Irritation and. 2001;17:471-483.
5. Winder C, Michaelis S. Crew Effects from Toxic Exposures on Aircraft. In: *Handbook of Environmental Chemistry, Volume 4, Part H.* Springer-Verlag Berlin / Heidelberg; 2005:223-242. doi:10.1007/b107246

Origins of Contaminated Air

Tristan Loraine

Global Cabin Air Quality Executive, London, England

Corresponding author:

Tristan Loraine

tristan@tristanloraine.com

KEYWORDS

bleed air, oil, contaminated air events, lubricant, air filtration

ABSTRACT

The issue and debate around the contamination of the breathing air supply in aircraft has existed since the dawn of pressurized flight. Since the introduction of 'bleed air' in the late 1940s, aviation has seen a steady increase in reports of the air supply being contaminated. From US Air Force crews in the 1950s being adversely affected in flight, to passenger and crew exposures still occurring in 2017. This paper seeks to provide the reader with a brief overview of the history of this important on-going health and flight safety issue.

INTRODUCTION

Aviation as we know it was born in 1903 when the Wright brothers carried out their short but historic flight. Six years later in 1909, Louis Beirort became the first man to fly the English Channel. In 1909 Alcock and Brown carried out the first crossing of the Atlantic having flown 1,890 miles (3,040 km) in 15 hours 57 minutes. This was followed in 1927 when Charles Lindbergh made the first solo nonstop flight across the Atlantic from Roosevelt Field, Long Island, New York, to Paris, France. Lindbergh covered the 33 1/2-hour, 3,600 statute miles (5,800 km) in a single-engine purpose-built Ryan monoplane, Spirit of St. Louis. In 1939, the first jet-powered aircraft flew, the Heinkel He 178 and on 14th October 1947, Chuck Yeager broke the sound barrier in a Bell X1.

In just 44 years humankind had gone from a few hundred feet to faster than the speed of sound and beyond the

troposphere and into the stratosphere.

Lindbergh and other record breakers knew high altitude flight was needed for long sector flying to avoid the potentially serious consequences of adverse weather located in the troposphere. At altitudes above 10,000 feet (3,000 m) above sea level, there is a need to protect crew and passengers from the risk of a number of physiological problems caused by the low outside air pressure above that altitude. Pressurization could solve the problem of not having to supply supplemental oxygen to prevent hypoxia.

The troposphere is the lowest layer of Earth's atmosphere, and is also where nearly all weather conditions take place. It contains approximately 75% of the atmosphere's mass and 99% of the total mass of water vapor and aerosols. The average depths of the troposphere are 65,617 ft (20,000 m) in the tropics, 55,774 ft (17,000 m) in the mid latitudes, and 22,966 ft (7,000 m) in the polar regions in winter. The temperature of the troposphere generally decreases as altitude increases by about 2°C per 1,000 ft. The pressure of the atmosphere is maximum at sea level and decreases with altitude.

The experiences of the pioneer high altitude balloon and fixed wing pilots showed aviation that to survive high altitude flight, a pressurized cabin would be needed. The first aircraft to fly with a pressurized cockpit was the Engineering Division USD-9A that first flew in 1921. The first pressurized passenger airliner was Boeing Model 307 Stratoliner that flew in 1938. Cabin superchargers ensured the aircraft could be pressurized by providing enough air to ensure it had an 8,000 foot cabin whilst flying at 15,000 feet. AiResearch Cabin Blowers led the way and providing enough air to pressurize leading aircraft of the time such as the Boeing B-29, which first flew in 1942, and the Lockheed L-647/749 Constellation, which first flew in 1943.

The introduction of jet engines in the 1940s provided a new potential way to pressurize aircraft. The Lockheed F-80 Shooting Star that first flew in 1944 took air

from the engine blower section of the General Electric J33-A-23 Single-stage centrifugal flow engine to pressurize the cockpit. At 30,000 feet the cabin altitude was 18,000 feet.

In the early 1950s the J57 engine took jet engine design to new levels and air was bled off the compression section of the axial flow engine. These new engines operated at far higher internal temperatures and needed a new type of oil to replace the previously used mineral oil. These new oils developed under military specification MIL-L-7808 were man made synthetic oils known as Type One or Three centistoke oils.

P. R. Bassett in his 1935 paper 'Passenger Comfort in Air Transportation' had stated that "even a trace of smell causes extreme discomfort in the air". Patent specification 651.576 entitled 'Improvements in and relating to Aircraft with Pressurised Cabins' proposed that an air 'Purifier' be fitted between the engine air off take and the aircraft cabin but 70 years on the only aircraft flying with any form of bleed air filtration are DHL Boeing 757 aircraft that have cockpit filter units fitted to their Boeing 757 Rolls-Royce powered aircraft.

Although aircraft like the Boeing 377 Stratocruiser had carbon monoxide detectors and basic filters fitted, none of the early jet aircraft had any form of contaminated air warning systems fitted, which is still the case over 60 years later in civil passenger jet aircraft.

The introduction of these new oils in the J57 and other new modern jet engines led very quickly to a large number of reported contaminated air events on aircraft. Boeing in their document D-14766-2 from 1953 state in relation to oil contamination issues on their B-52 aircraft that "*The possible toxic effect of contamination is still unknown' and that 'Obvious increases in the level of contamination level were noted during changes in engine power conditions.'*"¹

Douglas in their 1954 XC-132 Engine Compressor Bleed Air Contamination Study relating to J-57 and T-57 engine contamination problems state: "*Apparently the*

occurrence is completely erratic, with no predictable pattern since contamination has occurred all modes of airplane operation, such as take-off, high altitude cruise, descent and taxi. So far there is no known condition or sequence of conditions, which will reliably reproduce the trouble."²

One of the first pilot reports of contaminated air was made on 15 May 1954 by William J. van Every.³ He stated: "*At approximately 1530 hours on 15 May 1954, I was flying aircraft number 52-1436, an RB-57A, in a three (3) plane formation from Shaw Air Force Base, South Carolina. Approximately 40 minutes after take-off while flying over an overcast at 7000 feet, I experienced blurred vision, became nauseated and experienced considerable dizziness. I recall no strange or unpleasant odors, nor did I taste anything out of the ordinary. I did feel a definite dryness of mouth and throat. This condition lasted possibly a minute or two. As I became more aware of the situation or nearly to the passing out point I recall dropping back from the formation and opening the clear vision window and unhooking the oxygen mask. Fresh air from this open window seemed to relieve the unpleasant conditions I felt.*"

Captain William Hardin made a similar report two days later: "*At approximately 1015 hours on 16 May 1954 I became sick while flying RB-57A aircraft 852-1444. I was flying at 10,000 feet occasionally climbing over clouds up to 12,000 feet, aircraft had no oxygen aboard. I was flying with pressurization on, dump valve closed and full cold position due to heat. After being airborne approximately 45 minutes I became sick (metallic taste) to stomach with dryness of mouth, throat and stomach. Pressurization was turned off and clear vision panel opened and I immediately began feeling better. Flight was continued for about 1 hour and 15 minutes with no further effects during flight or after flight.*"³

A 1955 paper by Ted A. Loomis, Captain, MC and Stephen Krop, Ph. D. entitled 'Cabin Air Contamination in RB-57A' states:³

- The present studies involving exposure of humans

to the cabin air at the engine test facility while the lubricant was sprayed into the intake of the engine demonstrated that illness can occur as a result of such exposure.

- Smoke or fog is not an adequate indication that excessive lubricant is being used by the engine as symptoms appeared before amounts of the lubricant great enough to produce smoke were present.
- It would be reasonable to expect similar illness following prolonged exposure to even lower concentrations of the lubricant (and/or its breakdown products) than were used in this study.

The aviation industry was concerned enough by the possibility of contaminated air that many early passenger jet aircraft used turbo compressors rather than bleed air to ensure the air could not become contaminated. These included aircraft such as the Boeing Dash 80 (Boeing 707), Douglas DC-8, Convair 880 and 990. The use of turbo compressors was suggested in a 1955 North American Aviation paper entitled 'Elimination of Engine Bleed Air Contamination'.⁴ The paper stated they had been aware of the oil contamination issue for the last two years, they suspected compressor bearing seals were the main source, they had taken an in-depth look at possible filters and concluded that: *'The Separate Compressor As A Solution – This method of eliminating contamination is considered to be the most positive... also the heaviest, most complicated and most expensive.'*

Despite well documented evidence of contaminated air events occurring, other European aircraft manufacturers using British Rolls-Royce engines opted to introduce unfiltered bleed air into the aircraft cabin for pressurization yet installed no form of contaminated air detection systems to warn when the air was contaminated. Aircraft such as the later versions of the Comet and the Sud Aviation SE 210 Caravelle. The last aircraft before the introduction of the Boeing 787 to fly without using bleed air was the Vickers VC-10, which flew in 1962. The Boeing 787, which first flew in

December 2009, was the first airliner to return to not using bleed air after 47 years of continuous bleed air use in aircraft. The Boeing 787 opted to use electrical compressors and to have a totally bleed free architecture.

Since 1962 when all aircraft have used bleed air there have been a growing number of reported contaminated air issues. A 1973 paper by Aviation Medicine and Safety Research entitled 'Analytical Considerations Concerned with Cephalalgia on the DC-10' states: *"it appeared to be quite probable that the source of the headaches could be contaminants derived from the engine bleed air source for cabin pressurization."*⁵ A 1984 BAe 146 Service Information Leaflet SIL 21-7 states: "If the system becomes contaminated by oil, unpleasant cabin odour may be alleviated by..." and goes on to make suggestions of how to manage the problem.⁶ In 1984 a US occupational health physician prepared a report for a flight attendant union suggesting *"Mobil Jet II has been implicated as a causative agent"* with adverse health effects in those exposed.⁷ It was reported in 1991 that captains in East West airlines were "making a PA announcement to passengers and apologizing for the 'sweaty socks' smell" linked to oil contamination of the air supply.⁸

The U.S. ban on in-flight smoking began with domestic flights of two hours or less in April 1988 and was extended to domestic flights of six hours or less in February 1990, and then to all domestic and international flights in 2000. The smoking ban led to a significant increase in reporting of contaminated air events after the smoking ban, as they could no longer be masked by smoking smells.

In 1999, the term 'aerotoxic syndrome' was suggested to explain the health effects being seen in crew and passengers from those exposed to contaminated air in aircraft.

A Sunday Times headline of 17th September 2017 stated that: 'EasyJet to filter toxic air in cabins' as a consequence of easyJet becoming the first airline in the world to order the new Pall Aerospace 'Total cabin air

filtration' system being developed by Pall Aerospace. The system is accompanied by a new sensor system to warn when the air is contaminated by engine oils, hydraulic fluids, or carbon monoxide.

There are over 20,000 commercial airliners flying today around the globe using a bleed air system to provide breathing air to occupants yet 99.9% have any form of bleed air filtration or contaminated air warning systems fitted.

References

1. Gutkowski G, Page R, Peterson M. *D-14766-2. B-52 Decontamination Program*. Seattle: Boeing; 1953.
2. Waddock R. *Report No. SM 15195. Engine Compressor Bleed Air Contamination Study. XC-132 Project*, . Santa Monica: Douglas Aircraft Company; 1954.
3. Loomis T, Krop S. *MLSR No. 61 - Cabin Air Contamination In RB-57A Aircraft*. Maryland: Army Chemical Center; 1955.
4. Reddall HA. *Elimination Of Engine Bleed Air Contamination - SAE Paper 1955 -550185*. Warrendale: Society of Automotive Engineers; 1955. doi:<http://dx.doi.org/10.4271/550185>
5. Gaume J. *Analytical Considerations Concerned With Cephalalgia On The DC-10*. Long Beach: McDonnell Douglas Corporation (Unpublished report); 1973.
6. British Aerospace. *BAe 146 Service Information Leaflet 21/7: December 1984 - Oil Contamination of Air Conditioning System*. British Aerospace; 1984.
7. Cone J. *Interim Report No. 1 & 2- Association of Professional Flight Attendants Health Survey. San Francisco General Hospital Medical Center. Occupational Health Clinic. September 1983, June 1984*. San Francisco: San Francisco General Hospital Medical Centre (Unpublished report); 1984.
8. Buist L. *Memorandum: BAe 146/300 SRS Aircraft -Passenger Cabin Smells and Odours: 11 June 1991*. East West Airlines

Air Accident Investigation Findings and Recommendations: Aircraft Contaminated Air Events

Tristan Loraine

Global Cabin Air Quality Executive, London, England

Corresponding author:

Tristan Loraine

tristan@tristanloraine.com

KEYWORDS

bleed air, accident investigation, recommendations, human health, contaminants

ABBREVIATIONS

AAIB	Air Accidents Investigation Branch
AIB	Air accident investigation bureaus
APU	Auxiliary power unit
BFU	German Federal Bureau of Aircraft Accident Investigation
ICAO	International Civil Aviation Organization

ABSTRACT

Over the last two decades, a number of reports have been published by various air accident investigation bureaus (AIB) related to aircraft bleed air contaminated air events. This paper provides a quick review of the key findings, conclusions and recommendations in these reports from nine different countries.

INTRODUCTION

Aviation safety is advanced by reports, investigations and a reported 'no blame' culture, however most contaminated air events are never reported. Of those that are reported, most are not investigated by AIBs and investigators often lack subject matter expertise.

The basis for air accident investigations are predicated on the International Civil Aviation Organization (ICAO) annex 13. As an example of air accident investigation

bureaus (AIB) investigation legal basis, the European regulation 996/2010 requires that all accidents and serious incidents be investigated. The safety investigation authority or AIB may decide to additionally investigate incidents "when they expect to draw safety lessons from them." The scope of the investigation and procedure to be followed depend on lessons that are expected to be drawn from them for the improvement of aviation safety, especially taking into account the need for the cost-efficient utilization of investigation resources in the European Union.¹

Under ICAO and the EU regulation 996/2010, an accident includes a person being seriously injured as a result of being in the aircraft. A serious injury includes an injury which is sustained by a person in an accident involving hospitalization for more than 48 hours, commencing within seven days from the date the injury was received or injury to any internal organ. A serious incident is defined as an incident involving circumstances indicating that there was a high probability of an accident. Listed examples of serious incidents include fires and smoke in the passenger compartment, events requiring the emergency use of oxygen by the flight crew (pilots), and flight crew incapacitation in flight.

AIBs differ somewhat in their interpretation of incidents that require investigation. The German BFU for example reports that "according to the Commission Regulation (EC) 996/2010 and the law relating to the investigation into accidents and incidents associated with the operation of civil aircraft, the BFU can only investigate cases relevant for aviation safety. These include fire or smoke on board, occurrences which force the flight crews to don their oxygen masks and any flight crew incapacitation during the flight. Observation of odours, or smoke, irritations or headaches only becomes part of an investigation if they originate from fire or incapacitation."² Many other investigation reports involve incidents where impairment occurred or a contaminated air event was reported. The extent of the investigation and reports vary widely as expected based upon the regulatory requirements listed above. The AIBs in Australia and Germany have both produced a general overview report

AIB investigations: Countries	Number of AIB recommendations
Australia	Australia x 7
Austria	Austria x 6
France	
Germany	Germany x 5
Iceland	Iceland x 1
Ireland	Ireland x 1
New Zealand	
Portugal	
Spain	Spain x 1
Sweden	Sweden x 4
Switzerland	
UAE	UAE x 8
UK	UK x 13
Total: 13 Countries	Total: 46 in 9 countries

Table 1 – Air Accident Investigation Bureau Investigation

on fume events, while a 2004 UK report broadened its review to look at a variety of aircraft reporting fume events.³⁻⁵

As shown in Table 1, AIB Investigation reports have been produced in 13 different countries. Out of these countries nine of them have made AIB recommendations or similar based on their investigation. The UK AAIB has made 13 recommendations in five different reports, while Germany has produced five recommendations in two reports and Austria and the UAE have made six and eight recommendations respectively in one report each. A total of 46 differing AIB recommendations have been identified.

Table 2 provides a breakdown analysis of the different types of recommendations. Nine recommendations relate to airworthiness, maintenance and certification, while eight refer to research on the oils and other bleed air supply contaminants and effects on human health. Seven

recommendations relate to the introduction of bleed air supply detection and warning systems. Other areas included amendments to checklists and use of oxygen and protocols for crew and passengers during and post event reporting, among others.

It is however not mandatory for the organizations to whom the recommendations are addressed to undertake the recommended action. The EU regulation for example states *“The safety recommendations resulting from an accident or serious incident investigation or other sources, such as safety studies, should always be considered by the competent authority and, as appropriate, acted upon to ensure adequate prevention of accidents and incidents in civil aviation.”*¹

Several examples of key recommendations include:

1. Sweden: RL 2001:41e R1 – that existing emergency checklists and emergency training programs are

Recommendation	No.	Recommendation	No.
Airworthiness/ maintenance/certification	9	Research- oils/contaminants and effect on health	8
Data analysis	3	Develop treatment protocol	1
Reporting	3	Research – identification of oil contaminants in cabin air	1
Education and training	3	Detection/warning systems	7
Checklist/mandatory oxygen (100%) use	5	Filtration	1
Mandatory use of PBE	1	Emergency evacuation/procedures	1
Crew/passenger protocol during/post event	5	Safety risk assessment	2
International database	2		

Table 2 – Categorization of Air Accident Investigation Bureau Recommendations

complemented regarding immediate steps to be taken when suspicion arises that the cabin air is polluted. The instruction for such occasions shall call for the immediate use of the oxygen mask selected to 100%.⁶

- UK: Safety Recommendation 2007-002 – It is recommended that the European Union Aviation Safety Authority (EASA) consider requiring, for all large aeroplanes operating for the purposes of commercial air transport, a system to enable the flight crew to identify rapidly the source of smoke by providing a flight deck warning of smoke or oil mist in the air delivered from each air conditioning unit.⁷
- Germany: Safety Recommendation 07/2014 – EASA should implement a demonstration of compliance of cabin air quality during type certification of aircraft (CS-25), engines (CS-E) and APU (CS-APU) such that the same requirements apply to all these products and permanent adverse health effects resulting from contaminated cabin air are precluded. Aircraft

engine and APU type certification should include direct demonstration of compliance of all substances liable to cause cabin air contamination. Certification should be based on critical values which preclude permanent adverse health effects on passengers and crew.⁵

- Spain: REC 15/2016 – It is recommended that the International Civil Aviation Organization (ICAO) monitors research and/or studies conducted by organizations representing civil aviation, authorities, industry and academic research institutions to determine the real impact that exposure to contaminated cabin air has on human health and takes actions to improve safety, as necessary.⁸

The same recommendation listed above relating to detection systems was made to the Federal Aviation Administration (FAA) as Safety Recommendation 2007-003.⁷ Both recommendations were repeated in a further AAIB investigation report related to a B757 incident as the report stated “to date the AAIB has not received

formal responses to these recommendations.”⁹

A wide variety of key findings and conclusions have been outlined in the AIB reports examined. A few examples are listed below:

- Only fume events involving fire/smoke or those requiring the use of oxygen or pilot incapacitation must be investigated with lesser events not requiring investigation as not effecting safety;
- Fumes in the cabin are not new and are currently the subject of much industry discussion;
- As conditioned air is sourced from engine compressors on turbine engines, it is vulnerable to contamination from engine oil leaks that allow oil to enter the compressor air path;
- This incident and others show that prompt action by the crew in donning oxygen masks at the first signs of adverse symptoms can have significant safety benefits;
- A lot of fume events caused comfort limitations for the occupants but posed no danger;
- Cabin air contaminations during fume events have caused health impairments in occupants and impaired cabin crew in their performance;
- Two pilot impairment occurs;
- Impairment seen as an occupational health and safety (OHS) issue;
- Margin of safety rarely reduced as pilots used oxygen;
- Fumes from engine oils and hydraulic fluids is occurring in the cabin and flight deck on numerous aircraft types;
- Smoke or fumes in the flight deck or passenger cabin present the crew with a potentially hazardous situation, which requires prompt action;
- Inconsistent reporting is thought to have affected the quality of the evidence;
- No means of rapidly ascertaining the source of the fumes/ smoke was available to the crew;
- Smoke protection for passengers is not a requirement on public transport aircraft;
- Maintenance difficulty in identifying the source;
- The regulations put the onus on the system design

for clean air, with little requirement placed on the constituents of the lubricating engine oils so as not to be harmful to, or affect, the occupants of aircraft;

- There was a lack of general information available on potential contaminants of the bleed air by engine oil, and their effects on human physiology.

An AIB report on a B757 related to transient oil fumes after takeoff and adverse effects experienced soon after, stated: *“During the descent, both crew members began to feel disorientated and found that they had to concentrate hard to carry out their normal duties. At this point the commander began to feel ‘confused’... The flight crew expressed concern that neither had detected the slow degradation in their performance as this only became fully apparent after they had donned oxygen masks and began to recover.”*¹⁰

Upon careful review, very different patterns of thinking can be seen. As an example:

- Sweden: *“The Incident was caused by the pilots becoming temporarily affected by probably polluted cabin air.”*⁶ In this case oil leakage was identified during ground and air investigations after the event. The captain subsequently lost his medical certificate to fly due to ill health.
- Switzerland: *“The serious incident is attributable to the fact that on approach to Zurich Airport the cockpit filled with fumes which caused a toxic effect, leading to a limited capability of acting of the copilot. These fumes were caused by an oil leak...”*¹¹ In this case oil leakage was reported during post event investigations.
- Germany: Very few cases, affected safety/impairment is an occupational health and safety (OHS)/comfort issue.⁵

Other factors leading to difficulty in post flight investigations include:

- Significant under-reporting.
- No contaminated air detection systems are available, despite CS/FAR 25.1309c requirement.

- Very low levels of oil leakage can lead to fumes.
- Levels identified in cabin air quality investigations are consistently low. However safe limits do not apply to the aircraft environment.
- It is very difficult to confirm low level oil leakage by currently available maintenance procedures.

CONCLUSIONS

In summary, the above AIB investigation reports have significant implications for flight safety as well as occupational and public health. The problem of contaminated air is definitely under-recognized. Specialist expertise for AIB investigations is required and investigations should look at the broader picture and if necessary, gather perishable evidence, look at operational, maintenance and human data and take into account all factors relevant to contaminated air exposures.

7. AAIB. *AAIB Bulletin: 4/2007 G-JECE EW/C2005/08/10*. Aldershot: Air Accidents Investigation Branch; 2007.
8. CIAIAC. *Report A-008/2013: Accident Involving a Boeing B-757-300, Registered D-ANOC, Operated by Condor at the Gran Canaria Airport on 22 March 2013*. Madrid: Comisión de Investigación de Accidentes e Incidentes de Aviación Civil.; 2013.
9. AAIB. *EW/C2006/10/08. AAIB Bulletin: 6/2009 G-BYAO*. Aldershot: Air Accidents Investigation Branch.; 2009.
10. AAIB. *AAIB Bulletin: 7/2007: EW/C2006/10/10*. Aldershot: Air Accidents Investigation Branch; 2007.
11. AAIB. *Report No. u1884. Investigation Report Concerning The Serious Incident To Aircraft AVRO 146-RJ 100, HB-IXN*. Payerne: Swiss Transportation Safety Investigation Board; 2006.

References

1. European Union. *Regulation (EU) No 996/2010 Of The European Parliament And Of The Council of 20 October 2010 on the Investigation and Prevention of Accidents and Incidents in Civil Aviation.*; 2010.
2. BFU. *Investigation Report:BFU 5X018-10-Airbus / A319-132. 19 December 2010*. Braunschweig: Bundesstelle für Flugunfalluntersuchung- German Federal Bureau of Aircraft Accident Investigation; 2015. [https://www.bfu-web.de/EN/Publications/Investigation Report/2010/Report_10_5X018_A319_Koeln-Bonn_Smell.pdf?__blob=publicationFile](https://www.bfu-web.de/EN/Publications/Investigation%20Report/2010/Report_10_5X018_A319_Koeln-Bonn_Smell.pdf?__blob=publicationFile).
3. AAIB. *EW/C2000/11/4. Aircraft Accident Report No. 1/2004.BAe 146-200, G-JEAK. Vol 1*. Aldershot: Air Accidents Investigation Branch; 2004.
4. ATSB. *An Analysis of Fumes and Smoke Events in Australian Aviation: A Joint Initiative of Australian Aviation Safety Agencies: Aviation Research Report:AR-2013-213*. Canberra: Australian Transport Safety Bureau and Civil Aviation Safety Authority; 2014.
5. BFU. *BFU 803.1-14. Study Of Reported Occurrences In Conjunction With Cabin Air Quality In Transport Aircraft*. Braunschweig: Bundesstelle für Flugunfalluntersuchung; 2014.
6. SHK. *Report RL 2001 : 41e. Incident Onboard Aircraft SE-DRE. Sweden, 12 November 1999*. Stockholm: Statens haverikommission (SHK) Board of Accident Investigation; 2001.

Case study: BA 286 & BA 12

Susan Michaelis

University of Stirling, Stirling, UK

Corresponding author:

Susan Michaelis

susan@susanmichaelis.com

ABBREVIATIONS

CDC Centre of Disease Control

ABSTRACT

A review of two Airbus A380 flights is provided that involved reported contaminated air via the aircraft air supply system. Details of the flight, short- and longer-term effects on the crew and key flight safety implications are provided. The pattern of effects identified are consistent with those seen in other contaminated air events, with a clear need for airline operational improvements and a suitable medical protocol to be developed.

INTRODUCTION

The pattern of effects in the two cited incidents are consistent with contaminated air exposure on aircraft and those identified in Michaelis *et al* (2017).^{1,2} It is therefore very likely that a contaminated air event related to the bleed air system occurred and not at all unsurprising that no fault was identified. There is a clear need for a suitable medical protocol for such events. Improved reporting is required, with the Global Cabin Air Reporting System (GCARS) that is in development being a recommended international reporting tool. There is an urgent need for aircraft air detection systems to be fitted as per CS 25.1309c. Flight safety was degraded in these incidents and numerous shortcomings were highlighted. Both short and long-term adverse health effects were reported. A more thorough investigation is definitely warranted as safety lessons can be learned.

Case studies

1. BA 286: Airbus A380

A British Airways flight, BA 286 departed San Francisco for London Heathrow on 25 October, 2016. There were 433 people on board the A380, consisting of 25 crew and 408 passengers. Approximately one hour after departure the captain reported to air traffic control that there were “toxic fumes, toxic gas type fumes” in the aircraft.^{3,4} While overhead Alberta, the initial decision was made to divert to Calgary, however this was amended to Vancouver (YVR) due to increased ground support for the large Airbus A380 at YVR.

A Canadian Civil Aviation Daily Occurrence System (CADORS) reports that “*due to sickness with some crew and passengers*” the aircraft dumped fuel, declared a PAN call and diverted to YVR.⁵ The report describes “*a strong noxious smell located near the number 4 main cabin door and upper flight deck galley.*” The report categorization was listed under smoke/fumes in aircraft, crew incapacitation, medical emergency, fuel, declared emergency/priority and diversion.

All 25 aircrew were sent to hospital as a precautionary action, with three crew and one passenger requiring medical attention. All were subsequently released.

British Airways and Airbus inspected the aircraft in YVR, but no fault was identified and the aircraft was flown back to the UK with flight crew and maintenance personnel only. In flight troubleshooting identified no faults and the aircraft was subsequently released for further service.⁵

The author as a qualified air accident investigator and an expert in cabin air contamination was asked by the Global Cabin Air Quality Executive (GCAQE) to undertake a debriefing session with a number of the crew in the UK over the following 10 days, while blood was drawn. The following facts were

Symptom category	Acute	Short-term	Medium-term	Long-term*
Neurological	15	12	9	5
Central Nervous System	13	11	8	2
Peripheral Nervous System	9	3	3	3
Neurobehavioral	12	8	8	3
Gastrointestinal	10	8	7	0
Respiratory	8	8	8	4
Cardiovascular	6	9	8	2
General	4	9	9	5
Irritant	8	4	2	0

Table 1 — Symptoms for BA 286 and BA 12

established.

Many of the cabin crew in various areas of the aircraft reported a strong noxious /intoxicating fume smell. Eleven of the 25 aircrew were affected to varying degrees ranging from nausea and a metallic taste to incapacitation. Oxygen was used by at least one of the pilots. A number of passengers reported the fumes, described by one as “someone with their shoes off” with some reporting adverse effects.³ Paramedics met the aircraft on arrival to monitor the crew and passengers requiring help. One passenger advised that they were told they would need to pay \$800 CAD to go to hospital as the airline did not have the cash available to assist them to be examined in hospital.³

Blood was drawn from 12 crew and three passengers in order for it to be tested by the Centre of Disease Control (CDC) in the US based upon their protocol looking for ortho-cresyl phosphate adducts to butyrylcholinesterase in human serum.^{6,7}

2. BA 12: Airbus A380

An Airbus A380 aircraft departed Singapore for London on November 9, 2016. On take-off some of the cabin crew reported a fume event described as ‘dirty/smelly socks’. The pilots contacted Medlink, upon which anxiety was suggested by the flight deck to be the cause. A cabin crew member who was assisting a cardiologist doctor/passenger onboard reported that this was denied by the doctor who assessed the affected aircrew. Ativan/lorazepam was suggested by Medlink but was refused by the affected cabin crew. The flight was continued for the 13-hour flight to London. Five cabin crew undertook the debriefing by the author and had their blood drawn in a similar manner to the BA286 crew.

RESULTS

The range of symptoms for both BA 286 and BA 12 can be seen in Table 1.

Long-term effects were ten months + after fume event / Only eight crew followed up to date.

Return to work timeframe	Number of people	Comments on range of long-term effects remaining at 10 months
Immediate -1 month	4	1- numerous 2 - some 1 - none
>1 month -6 months	1	1- some
>6 months-10 months	2	2 -numerous
Still off work	1	1 -numerous

Table 2 — Crew Long-Term Effects at 10-Month Follow-Up

Various other points of interest are listed below:

- A smell/ fume was identified by 12 of the 20 crew (three passengers) interviewed.
- The smell was described as that of dirty socks. Sweaty socks, toxic smell, glue, plastic smell, cheesy smell....
- Six crew were incapacitated
- Oxygen was used by nine+ cabin crew
- Most paramedics tests found no abnormalities
- All (limited) tests at the hospital were assessed as normal
- Previous events: three of the crew reported previous major events, two reported fume events as regular and one reported them as occasional
- Most of the crew advised there was no training for fume events
- Most of the crew had been flying for many years
- BA12 crew experienced increased range of effects and longer-term than BA 12, perhaps as the flight was not diverted.

Eight of the 17 crew were followed up ten months after the events. The findings are outlined in Table 2. All except one crewmember had returned to work, with a number of the crew reporting on-going longer-term effects. Three of the seven crew that had returned to work reported

numerous longer-term effects remaining, while three reported some effects remaining at the 10-month review.

Investigation

The official investigations undertaken by Airbus and the airline indicated that no fault was found (NFF) with the aircraft. Unofficially some of the crew advised that the Vancouver emergency services identified higher readings at the rear of the aircraft. The aircraft was ferried home the following day. No AAIB (Aircraft Accident Investigation Branch) investigation was undertaken as the airline and manufacturer advised that no fault had been found. This is despite the AAIB being required to investigate serious incidents under the EU Regulation 996/2010. Safety investigation authorities may decide to investigate incidents “when they expect to draw safety lessons from them.”⁸

Serious incidents include those requiring emergency use of oxygen by the pilots, flight crew (pilot) incapacitation in flight, fires and smoke in flight, injury to internal organs and hospitalization for more than 48 hours within seven days of the incident.

The investigation for BA 12 was reported to finding no fault or NFF. It was unofficially reported that staining was found in the No. 3 engine. No AAIB investigation was undertaken.

Limitations of the case study

A number of limitations apply to the information collated from the debriefings including:

- Not all crew responded. On BA 286, 12 of the 25 crew undertook the debrief, while only five of the 25 crew on BA 12 participated;
- The information received was not complete in all cases;
- There were no on-board detection systems despite the EASA certification standard CS-25 1309C requiring “Information concerning unsafe system operating conditions must be provided to the crew to enable them to take appropriate corrective action. A warning indication must be provided if immediate corrective action is required. Systems.”
- Crew reluctance to provide complete information due to employment pressure;
- Access to maintenance records not available;
- Crew difficulty in getting medical support. Crew advised their general physician advised this was an occupational issue necessitating them to see their airline doctor or that they would help but did not recognize aerotoxic syndrome as a valid medical disease. Airline doctors were reported to have advised aerotoxic syndrome and fume related illness was not valid and they could not help;
- This study warrants further investigation and support.

Blood testing

The CDC in Atlanta volunteered to test the crew and passenger blood based on their published protocol.⁶ All costs were to be covered by the CDC. The CDC however required a government authority from either Canada, the USA or the UK to request the testing to be undertaken by the CDC. No government authority in the three countries would give permission. Those contacted included Transport Canada, Transport Safety Bureau in Canada, Public Health Canada, NTSB, FAA, Public Health England, AAIB (UK), CAA (UK).

The CAA advised in May 2017 that it would not give permission to CDC for the following reasons as an agreed outcome between the CDC and CAA.⁹

- The oCP-BChE adducts test is a scientifically validated test, i.e. it has been shown to be an effective method for measuring oCP-BChE adducts
- The test has not yet been clinically validated, i.e. the normal range in the general population / target populations has not been established or correlated with exposure to ortho isomers of TCP and we therefore do not know the clinical significance of a result in an individual subject
- The test is potentially of clinical value and therefore we have an interest in trying to facilitate scientific research that would help to validate this
- This would initially require a study of exposed subjects in an environment where the concentrations can readily be monitored and with a suitable non-exposed control group; it is likely that this work would be undertaken in either production or maintenance facilities

There has not yet been an opportunity to take this work forward, but I hope that it will be possible to engage with industry and to develop a research project with CDC in the foreseeable future—unfortunately I cannot give any timescale at the moment. Given that the test is not yet clinically validated, the UK CAA is not able support the testing of blood samples taken from crew on flights where fume events have been reported.”

However, it should be noted that Liyasova (2011), Schopfer (2014), Tacal (2014) were all research projects that have subsequently been published.^{7,10,11}

Is No fault found unusual?

It is very common after aircraft fume events that the investigations report no fault is found (NFF). A few examples include:

- EASA (2017) – “Of particular interest are the secondary TCAC-events, as these are fed from deposits. Inspection the checking of the engines after a TCAC-event can therefore lead to no findings.... The exact causes for the spontaneous release of pollutants from such deposits are still unclear It is conceivable that mechanical or thermal stress or

the introduction of solvents such as water or de-icing agents can trigger such an event.” TCAC = Technical Cabin Air Contamination with the origin in deposited oil contaminants inside the bleed air system and the air conditioning system.¹²

- Airbus (2013) - “ With lower levels of contamination the reports are often only associated with odors in the cabin. ... It is often difficult to immediately identify the exact source of contamination and without obvious signs such as abnormally high oil consumption, it is not uncommon to apply inappropriate maintenance action. ... There are of course already documented trouble shooting procedures although these are again usually more efficient in the case of heavy oil leakage. In the case of very light oil contamination it is very difficult to confirm leakage by the defined inspection procedures.”¹³
- CAA (2017) - Engine bleed air related incidents: “such events can be transient and it may not be possible for airlines to determine the specific source.”¹⁴

CONCLUSIONS

The pattern of effects in the two cited incidents are consistent with contaminated air exposure on aircraft and those identified in Michaelis *et al* (2017).^{1,2} It is therefore very likely that a contaminated air event related to the bleed air system occurred and not at all unsurprising that no fault was identified. There is a clear need for a suitable medical protocol for such events. Improved reporting is required, with the Global Cabin Air Reporting System (GCARS) that is in development being a recommended international reporting tool. There is an urgent need for aircraft air detection systems to be fitted as per CS 25.1309c. Flight safety was degraded in these incidents and numerous shortcomings were highlighted. Both short and long-term adverse health effects were reported. A more thorough investigation is definitely warranted as safety lessons can be learned.

References

1. Michaelis S, Burdon J, Howard C. Aerotoxic Syndrome : a New Occupational Disease ? *Public Heal Panor*. 2017;3(2):198-211.
2. Howard, C V, Michaelis S, Watterson A. The Aetiology of “ Aerotoxic Syndrome ” - A Toxicological Pathological Viewpoint. *Open Acc J Toxicol*. 2017;1(5):1-3. doi:10.19080/OAJT.2017.01.555575
3. Global news. Mysterious British Airways illness causes emergency landing at YVR. October 25, 2016. 2016. <http://globalnews.ca/video/3026014/mysterious-british-airways-illness-causes-emergency-landing-at-yvr>.
4. British Airways. BA 286- Captain report to Air Traffic Control - 25 October 2016: (min 3.15). Aircraft to ATC. <https://m.youtube.com/watch?feature=youtu.be&v=odAHH5AkqRE>. Published 2016.
5. Transport Canada. CADORS Occurrence report: 2016P1892- 25 october 2016. CADORS. <http://tiny.cc/gsaahy>. Published 2016.
6. Johnson D, Carter MD, Crow BS, et al. Quantitation of ortho-cresyl phosphate adducts to butyrylcholinesterase in human serum by immunomagnetic-UHPLC-MS/MS. *J Mass Spectrom*. 2015;50(4):683-692. doi:10.1002/jms.3576
7. Liyasova M, Li B, Schopfer LM, et al. Exposure to tri-o-cresyl phosphate detected in jet airplane passengers. *Toxicol Appl Pharmacol*. 2011;256(3):337-347. doi:10.1016/j.taap.2011.06.016
8. European Union. *Regulation (EU) No 996/2010 Of The European Parliament And Of The Council of 20 October 2010 on the Investigation and Prevention of Accidents and Incidents in Civil Aviation.*; 2010.
9. Dowdall N. Email from Dr Nigel Dowdall, Civil Aviation Authority UK, to Dr. Susan Michaelis: BA 286 and CDC consent - 30 May 2017. *Email*. 2017.
10. Schopfer LM, Masson P, Lamourette P, Simon S, Lockridge O. Detection of cresyl phosphate-modified butyrylcholinesterase in human plasma for chemical exposure associated with aerotoxic syndrome. *Anal Biochem*. 2014;461:17-26. doi:10.1016/j.ab.2014.05.021
11. Tacal O, Schopfer LM. Healthy F-16 pilots show no evidence of exposure to tri-ortho-cresyl phosphate through the on-board oxygen generating system. *Chem Biol Interact*. 2014;215(1):69-74. doi:10.1016/j.cbi.2014.03.004
12. EASA. *Research Project : CAQ Preliminary Cabin Air Quality Measurement Campaign. Final Report EASA_REP_RESEA_2014_4*. Cologne: European Aviation Safety Agency; 2017. https://www.easa.europa.eu/system/files/dfu/EASA_CAQ_Study_Final_Report_21.03.2017.pdf.
13. Airbus. *Environmental Control System Decontamination. Reference 21.00.00018. First Issue Date 07 November, 2013. A318;A319;A320;A321*. Toulouse: Airbus; 2013.
14. CAA. CAA: Health Information for Passengers/Cabin Air Quality. <https://www.caa.co.uk/Passengers/Before-you-fly/Am-I-fit-to-fly/Health-information-for-passengers/Cabin-air-quality/>. Published 2017. Accessed October 22, 2017.

EASA and FAA Research Findings and Actions—Cabin Air Quality

Susan Michaelis

University of Stirling, Stirling, UK

KEYWORDS

cabin air, environmental control system, oil contamination, fume event

ABBREVIATIONS

APU	Auxiliary power unit
CAQ	Cabin air quality
EASA	European Aviation Safety Agency
FAA	Federal Aviation Administration
GCAQE	Global Cabin Air Quality Executive
OPC	Organophosphate compounds
TCAC	Technical cabin air contaminations
TCP	Tricresyl phosphate

ABSTRACT

A brief summary of the historical and recent initiatives undertaken by two of the key aviation regulators, EASA and the FAA is outlined below. This will put into context their roles in the ongoing international aircraft cabin air quality issue.

INTRODUCTION

The Global Cabin Air Quality Executive (GCAQE) presented the historical and current key actions undertaken by the Federal Aviation Administration (FAA) and European Aviation Safety Agency (EASA) in relation to aircraft air supplies contaminated by engine-generated compounds via the aircraft bleed air system.

The GCAQE undertook this initiative as EASA, the European aviation regulator had agreed to present their most recent research, but after agreeing to participate, EASA withdrew from both attending and presenting at the conference at short notice. The FAA, the US aviation regulator was asked to present their activities on the cabin air quality (CAQ) topic in February 2017,

but advised they were too busy to find a speaker or to attend.

FAA

In 1994 the FAA provided evidence to the US Senate hearings on airliner CAQ advising that “*all of the studies confirm to us that the air quality aboard an aircraft is at least as good as that commonly found in many other indoor workplaces or office environments.*”¹ The committee reported that “*despite findings of various studies that airliner cabin air is generally safe for healthy people*”, concerns continued to be voiced by flight attendants and passengers.¹

A 2001 review of cabin air quality undertaken by the US National Research Council (NRC) found that oil, hydraulic fluids and their decomposition products posed a moderate concern.² Recommendations included for the FAA to rigorously demonstrate the adequacy of the Federal Aviation Regulations (FARs) related to CAQ and for it to revise standards to protect the health and comfort of crew and passengers if required. The FAA was recommended to investigate and publicly report on the need for and feasibility of installing air-cleaning equipment for removing particles and vapors from the air supplied by the environmental control system (ECS) on all aircraft to prevent or minimize the introduction of contaminants into the passenger cabin during both normal operation and during air quality incidents. Additionally the FAA was recommended to require carbon monoxide (CO) monitor in the supply air ducts and to establish procedures for responding to elevated CO levels. It was also recommended that the FAA collect data related to health and air quality incidents to determine if a relationship existed between health effects or complaints and CAQ.

The 2002 FAA response to the NRC was extensive and advised that “*FAA rulemaking may not have kept pace with public expectation and concern about air quality and does not afford explicit protection from particulate matter and other chemical and biological hazards.*”³ The FAA reported that it would establish an Aviation Rulemaking Advisory Committee (ARAC) to review the existing

standards related to the CAQ and if found inadequate they would propose revisions and/ or new standards. The assessment was to be fairly extensive, suggesting the air quality regulations may evolve into a more comprehensive standard that adopts applicable parts of an existing consensus standard for environmental health. None of the NRC recommendations were met and the ARAC committee was never established and was postponed indefinitely.⁴

In 2003 US public law 108-176 directed the FAA to undertake studies recommended by the NRC related to ozone, pesticides, analysis for contamination of air supply duct filters and the establishment of a reporting system.⁵ The FAA Center of Excellence was established in 2003 with funding through to 2013. This involved numerous studies undertaken by the Airliner Cabin Environment Research (ACER) group, which became Research in Intermodal Transport (RITE) and the Occupational Health Research Consortium in Aviation (OHRCA). The ACER-RITE/OHRCA funded studies from 2003 to 2013 included in excess of \$23 million in FAA grants and \$28 million in matched industry funding. The studies included areas such as recirculation filters; incident monitoring and reporting; medical protocol for bleed air contamination; cabin flow dynamic models and sensors; contaminant transport in aircraft; sensors and prognostics to mitigate bleed air contamination; on-board monitoring and measurement methods; effect of partial pressures on passengers, ozone and flame retardants. In relation to the study addressing exposures to oil fumes and reported ill health, the FAA funded the work but failed to compel airlines to participate, so no definitive conclusions could be drawn.⁴

In 2004, the FAA published an airworthiness directive (AD) involving inspection and cleaning practices on the BAe 146 series aircraft. The AD was reported as *“necessary to prevent impairment of the operational skills and abilities of the flightcrew caused by the inhalation of agents released from oil or oil breakdown products, which could result in reduced controllability of the airplane.”*⁶

A joint NASA/FAA and USAF VIPR (Vehicle Integrated Propulsion Research) project was established in 2011 and consisted of three parts, some of which related directly to aircraft bleed air contamination. For example Jones *et al.* reported that oil contamination in the compressor will result in a fog of very fine droplets (10-150 nm) in the bleed air *“under most operating conditions.”*⁷ It was therefore suggested that *“the development of sensors for detecting oil contamination in aircraft bleed air should focus on ultrafine particle detection and sensing of low contamination levels may require sensitivity to extreme ultrafine particles 10 nanometers and smaller.”*⁷

In 2012 the FAA modernization Reform Act, H.R 658 legislated a study of bleed air quality in aircraft cabins and research and development for cleaning and monitoring technologies for the engine and auxiliary power unit (APU) generated bleed air.⁸ This additionally involved identifying oil based and hydraulic and other toxins in the bleed air supply, to determine the specific amount and duration of toxic fumes in the cabin air that constitutes a health risk to passengers, develop a systematic reporting standard for smoke and fumes events in aircraft cabins and to identify potential health risks to individuals exposed to toxic fumes during flight. The FAA was to require domestic air carriers to allow monitoring of the air in a way that imposes no significant costs on the carrier and does not interfere with the normal operation of the aircraft. The FAA responded to Congress in 2013 as directed.⁹ The required activities were rejected by the FAA as it considered the work was already undertaken or not required. The FAA advised cabin air contamination events were too infrequent, the potential toxicity was speculative and that common standards for cabin air contaminants were lacking, thus inhibiting advanced cleaning and detection technologies. The FAA reported it would *“continue to consider cabin safety risk and sponsor research in this area appropriate to the risk level.”*⁹

The US Congress passed a further law under the FAA Reauthorization Act of 2018.¹⁰ This included making educational materials available via the FAA website

for pilots, flight attendants and maintenance workers on how to respond and report smoke and fume incidents onboard aircraft. The FAA was also directed to undertake research to develop techniques to monitor the bleed air under ACER, including: identifying and measuring the constituents and levels from bleed air events; assessing potential health effects of such constituents on passengers and air crew; identifying air supply monitoring and warning systems for bleed air contamination and potential techniques to prevent fume events. The FAA was required to report back to Congress not later than 18 months on the feasibility, efficacy, and cost-effectiveness of certification and installation of systems to evaluate bleed air quality.

Additionally, in 2018, the FAA issued a Safety Alert for Operators (SAFO).¹¹ The SAFO was issued *“to identify a need to enhance flight crew procedures that mitigate the risk to passengers and crew in the event of odors, smoke and/or fumes.”*¹¹

EASA

In 2009 EASA issued an Advanced Notice of Proposed Amendment (A-NPA) relating to *“Cabin Air Quality Onboard Large Aeroplanes.”*¹² This was to encourage discussion around sources of CAQ degradation. The primary issue of concern was listed as smoke/fume events in the cockpit and /or cabin of which it was stated: *“the vast majority of these events are associated with an abnormal leakage of engine or APU lubrication fluid (aviation engine oil).”*¹²

A Comment Response Document (CRD) to the A-NPA was issued in 2011.¹³ It stated that there was no safety case justifying an immediate and general rulemaking action because:

- There were no accidents (injuries / loss of life / major aircraft damage) with cabin air contamination as root cause;
- Serious incidents involving impairment or incapacitation of crew were rare. A focus was placed on *“dense visible fumes or concentrations of toxic products sufficient to incapacitate crew/passengers.”*

In such cases it was considered that existing procedures and equipment, including oxygen masks, were sufficient to mitigate any potential safety risk;

- The minor *‘nuisance’* of temporary bad smell events—due inappropriate maintenance or mechanical failures—were acknowledged as under-reported and not considered a threat to aviation safety. The frequency was unknown, but suggested to be less common than one in 10,000 flights.

The CRD also stated that a causal relationship between reported health effects and oil / hydraulic fluid contamination was not yet established. Therefore, with no conclusive scientific evidence available the Agency was unable to justify a rulemaking task to change existing designs or certification specifications. EASA advised health effects were not within its primary scope. However, it would continue to monitor the topic and put forward recommendations to further improve the knowledge in the fields of toxicity and health impact of oil fumes and bleed air filter and monitoring technologies.

The final decision in 2012 terminated the rulemaking task 25.035 *‘Cabin air quality on board Large Aeroplanes’* without amending EASA regulations, based on the reasons outlined in the CRD above.¹⁴

In 2014 EASA launched two research projects that were published in 2017. The first of the two projects related to a *“Research Project : CAQ Preliminary Cabin Air Quality Measurement Campaign.”*¹⁵ Sixty-nine measurement flights were performed on eight types of aircraft. Sixty-one of the flights were on bleed air aircraft, with eight undertaken on the bleed free Boeing B787 Dreamliner. Samples were taken at defined flight phases (taxi-out, take off and climb, descent and landing, complete flight). The findings included that traces of meta and para tricresyl phosphate (TCP) isomers and other organophosphate compounds (OPC) were found in most samples. The observed frequency, pattern and concentration levels were similar to findings of other indoor environments. Two types of TCP contamination were defined in two ways:

A) Ubiquitous permanent TCP release

Ubiquitous background low-level TCP can be found in all aircraft types including the B787. The source of this permanent release of TCP was suggested to be textiles, floorings, circuit boards, plastics and outside air, with the levels found said to be similar to other indoor environment and not at levels associated with harm.

B) TCP sourced to oil contamination of aircraft bleed air

1. Non-permanent event triggered TCP /engine oil release into the cabin— Technical Cabin Air Contamination-events (TCAC): 67% of the (500+) samples identified that the TCP contamination occurred sporadically during taxi out, takeoff and climb, descent and landing. These were sourced to oil triggered events in bleed air aircraft and identified as:
 - Primary TCAC-event. These TCP releases were sourced to seal failures and oil overfill and were said to be very rare.
 - Secondary T-CAC events. These TCP levels were sourced to TCP deposits in the bleed air system and air supply ducting related to the permanent low-level oil leakage from the APUs and engines (primary sources). The secondary event TCP release was said to be responsible for the more frequent smell events with non-toxic odourous compounds released into the cabin, of which the frequency was unknown. Inspection of the engines after an event will lead to no findings and the events can be triggered by thermo-mechanical influences on the deposits or the introduction of solvents such as water or deicing fluids.
2. Permanent engine oil /TCP (contaminant) release into the cabin— This type of contaminant release relates to event free scenarios with creeping oil component deposits sourced to bleed air. There is a permanent low-level TCP/oil entry via the bleed

air supply due to chronic seal failure. “Most engines might have a certain turbine oil leak rate”, but this was not identified in this study with the techniques utilized, either with the TCP not reaching the cabin or reaching the cabin but at levels below the limits of detection for the technology utilised. Future testing technology was not noted as requiring improvement and the TCP levels were said to be too low to effect CAQ.

In conclusion the study found:

- The ubiquitous low-level TCP leakage can be differentiated from oil triggered events (Technical cockpit/cabin air contamination);
- Ubiquitous low-level TCP can be from other sources including outside air;
- Permanent low-level TCP can be from the oil / bleed air system;
- Technical cabin air contaminations (TCAC) events have their origin in the bleed air technology;
- High cabin air exchange rates make the cabin less polluted than homes and offices;
- Most of the reported smell events cannot have technical (oil-related) causes due to their known rareness of occurrence;
- Oil triggered events are too low to cause harm to health - acute or chronic neurological effects. Hyperventilation and other causes are under consideration;
- Medical procedures should only be undertaken once the an exact classification of the CAC-event has been established;
- Cabin air contaminant levels are not likely detectable by currently applied bioanalytical methods;
- “The so-called ‘aerotoxic syndrome’ remains completely incomprehensible.”;
- Risk mitigation procedures should be at a reasonable cost benefit ratio;
- Oil investigations using conventional methods are no longer possible because of low levels of contaminants and rare occurrence rates;
- Future ‘large scale study’ should provide data “to end the misguided discussion on CAQ once and for all.”

In 2015 EASA commenced a “*Research project: AVOIL – Characterisation of the Toxicity of Aviation Turbine Engine Oils After Pyrolysis.*”¹⁶ The study reported that “*If seals within the engine are not performing effectively, oil and possibly thermal degradation products of oil can result in contamination of the bleed air. Besides contaminated bleed air, the ECS itself and the ducts can also be a secondary source of contaminants.*” Over 127 compounds were identified in all the oils and during different simulated flight phases with substantial changes in composition occurring during the lifetime of an oil. Six hundred thirty-four peaks were recorded of which 27% could be matched using the National Institute of Standards and Technology (NIST) library. Other findings include:

- High levels of aldehydes and CO;
- TCP was detected but not TOCP;
- No neuronal effects from neuroactive pyrolysis products were found using 30 minute or 24 hour *in vitro* exposures. Exposures of 48 hours or greater identified that neuronal activity was markedly decreased by the majority of TCP isomers and mixtures. Prolonged exposure to pyrolysis products may aggravate their potential neurotoxicity;
- Human sensitivity variability is largely unknown;
- Effects of chemicals combined with other occupational stressors is largely unknown;
- Some of the symptoms may not be caused by exposure to chemicals due to the wide variety and lack of specificity of symptoms reported;
- Conditions in cabin air may differ from the standard conditions on which exposure limits are normally based;
- Future research should focus on neuronal effects of prolonged and repeated exposures, toxicology of chemical substances identified (exposure levels, dose, molecular targets, no effect concentrations); use of exposure limits; effects relating to mixture toxicology; review of symptoms in air crew to investigate if a syndrome can be defined.

EASA suggests that based upon its two previous and other studies, all measurements on board aircraft during

normal operating conditions have shown that the cabin and cockpit air is very good compared to other indoor environments. While according to EASA, no causal association has been identified between cabin air contamination by oil mists and ill health, some incidents had shown a temporal relationship and therefore “*an association was nevertheless plausible and worth of further investigation.*”¹⁷

Therefore in 2017 EASA and the European Commission launched a further larger scale \$2 million study to focus primarily on oil contamination. “*The general objective of this research study is to enable step-advances in the investigation on the quality of the air on board commercially operated large transport aeroplanes and its potential adverse consequences on crew/passenger health in light of the relevant European legislation on quality of indoor air and professional exposure limits.*”¹⁷ The comprehensive strategy outlined under this EU FACTS cabin air quality study, covers both inflight, ground and laboratory testing, chemical analysis, neurotoxicity assessment, biomarkers, risk assessment and countermeasures and mitigation.¹⁸ The FACTS study will primarily focus on oil contamination incidents, i.e. abnormal events and exposure to low-dose mixtures.

DISCUSSION

While cabin air contamination by engine oils and other fluids has a long history, the regulatory approach has been unnecessarily delayed via the above actions. Much of the research has not yielded mitigating actions and protection for human health and flight safety. Importantly, major concerns have been raised about the recent EASA studies and the current FACTS study scope.¹⁹ The concerns addressed the tender process, industry stakeholder input, independence of study and oversight participants and the main aims and methodology of the research. The primary concerns are that the study fails to address chronic low-level exposure to the mixture, the reliance on occupational and indoor air quality guidelines and failure to take into account the current independent science.²⁰

CONCLUSIONS

The FAA and EASA have failed to ensure air quality in aircraft is clean as required by the regulations. The inactions or actions taken have ignored independent science, delayed or negated the implementation of mitigation strategies and have failed to take a precautionary approach.

References

1. US House of Representatives. Airliner Cabin Air Quality : Hearing before the Subcommittee on Aviation of the Committee on Public Works and Transportation, House of Representatives, One Hundred Third Congress, second session, May 18, 1994. https://archive.org/stream/airlinercabinair00unit/airlinercabinair00unit_djvu.txt.
2. NRC. *The Airliner Cabin Environment and the Health of Passengers and Crew.*; 2002.
3. ACERRT -The Airliner Cabin Environment Report Response Team. *Report to the Administrator on the National Research Council Report , “ The Airliner Cabin Environment and the Health of Passengers and Crew .”* Washington DC: Federal Aviation Administration; 2002.
4. Murawski J. The U . S . Regulatory Response to Oil Fumes in the Cabin and Flight Deck of Commercial Aircraft. In: *ICE International Aviation Conference - 9-10 March 2009.* ; 2009:1-4.
5. US Congress. *Public Law 108-176 (2003): Vision 100-Century of Aviation Reauthorization Act. Sec. 815. Air Quality in Aircraft Cabins.* Washington: US Congress; 2003. <https://www.gpo.gov/fdsys/pkg/PLAW-108publ176/html/PLAW-108publ176.htm>.
6. FAA. *AD 2004-12-05: Airworthiness Directive.* Washington DC: Federal Aviation Administration; 2004.
7. Jones B, Roth J, Hosni M et al. The Nature of Particulates in Aircraft Bleed Air Resulting from Oil Contamination. LV-17-C046. In: *2017 ASHRAE Winter Conference—Papers.* Kansas State University; 2017.
8. US Congress. *Public Law 112 - 95 (2012). FAA Modernization and Reform Act of 2012 - H.R. 658 – Section 320, S. 917.* Washington: US Congress; 2012. <https://www.congress.gov/bill/112th-congress/house-bill/658>.
9. FAA. *Federal Aviation Administration. Aviation Safety, AVS-1: Report to Congress Pub. L. No. 112-95, 126 Stat. 11 (2012) FAA Modernization & Reform Act Of 2012. Section 917 Research & Development of Equipment to Clean and Monitor the Engine and Auxiliary Power.* Washington: FAA; 2013. https://www.faa.gov/about/plans_reports/congress/media/Report_to_Congress_on_Engine_and_APU_Bleed_Air_Supplied_on_Pressurized_Aircraft.pdf.
10. US Congress. *Public Law No: 115-254 (2018): H.R.302 - FAA Reauthorization Act of 2018: SEC. 326. Aircraft Air Quality.* Washington: US Congress; 2018. <https://www.congress.gov/bill/115th-congress/house-bill/302/text#toc-H881FE59377DD4F22AE02B998EA733D79>.
11. FAA. *FAA SAFO: Safety Alert For Operators.* Washington DC: Federal Aviation Administration; 2018. http://www.faa.gov/other_visit/aviation_industry/airline_operators/airline_safety/safo.
12. EASA. *A-NPA-2009-10. Cabin Air Quality Onboard Large Aeroplanes.* Cologne: European Aviation Safety Agency; 2009.
13. EASA. *Comment Response Document (CRD) To Advance Notice Of Proposed Amendment (A-NPA) 2009-10 - Cabin Air Quality Onboard Large Aeroplanes.* Cologne: European Aviation Safety Agency; 2011. https://www.easa.europa.eu/system/files/dfu/CRD_to_A-NPA_2009-10.pdf.
14. EASA. *Decision No 2012/001/R of the Executive Director Of The European Aviation Safety Agency of 27th January 2012.* Cologne: European Aviation Safety Agency; 2012.
15. EASA. *Research Project : CAQ Preliminary Cabin Air Quality Measurement Campaign. Final Report EASA_REP_RESEA_2014_4.* Cologne: European Aviation Safety Agency; 2017. https://www.easa.europa.eu/system/files/dfu/EASA_CAQ_Study_Final_Report_21.03.2017.pdf.
16. EASA. *Research Project: AVOIL. Characterisation of the Toxicity of Aviation Turbine Engine Oils after Pyrolysis. Final Report EASA_REP_RESEA_2015_2.* Cologne: European Aviation Safety Agency; 2017. <https://www.easa.europa.eu/the-agency/procurement/calls-for-tender/easa2015hvp23>.
17. European Commission. *Call for Tenders N° MOVE C2/2016-363 -Research Study: Investigation of the Quality Level of the Air inside the Cabin of Large Transport Aeroplanes and Its Health Implication. Tender Specifications.* Brussels: European Commission - DG Mobility and Transport; 2016.
18. EASA-EU Commission. *FACTS- Aircraft air quality study.* 2017. <https://www.facts.aero/index.php/approach>.
19. GCAQE. *GCAQE Letter to Lambros Papadias Head of Inquiries Unit 3- EU Ombudsman- Complaint 1802/2016/CEC -“Investigation of the Quality Level of the Air inside the Cabin of Large Transport Aeroplanes and Its Health implication:No MOVE/C2/2016-36” FACTS Cabin Air .;* 2018.
20. Howard, C V. *European Commission FACTS CAQ Scientific Committee Meeting, Cologne 29/11/17.*; 2017. https://gcaqe.org/wp-content/uploads/2017/12/V_Howard_EASA_EU_FACT_SC_meeting_29Nov17.pdf.

Mechanisms and Regulatory Implications of Oil Leakage into the Cabin Air Supply

Susan Michaelis,¹ John Morton²

¹ University of Stirling, Stirling, UK

² European Sealing Association, Haute Savoie, France

Corresponding author:

Susan Michaelis

susan@susanmichaelis.com

KEYWORDS

bleed air, oil, seal failure, contamination, certification standards

ABBREVIATIONS

AMC	Acceptable means of compliance
APU	Auxiliary power unit
CS	Certification standards
EASA	European Union Aviation Safety Agency
FAA	Federal Aviation Administration
FAR	Federal aviation regulations

ABSTRACT

There are certification and airworthiness requirements relevant to the provision of clean breathing air for the aircraft crew and passenger compartments. A Masters of Science (MSc) research degree,¹ was undertaken to assess whether there is any gap between the certification requirements for the provision of clean air in crew and passenger compartments, and the theoretical and practical implementation of the requirements using the bleed air system. Low level oil leakage into the aircraft cabin in normal flight operations is a function of the design of the engine lubricating system and bleed air systems, both utilizing pressurized air as required. The use of the bleed air system to supply breathing air has regulatory implications that require changes to be implemented.

INTRODUCTION

There are extensive reports regarding concerns about contamination of the aircraft bleed air supply (fume

events) extending back to the early 1950s. This coincided with the introduction of synthetic jet oils that replaced mineral oils and the introduction of higher performing, higher temperature and pressure turbine engines.² Varying types of reports have continued to the present day such as military, airline, manufacturer and crew reports. Furthermore, there have been airworthiness directives, regulator initiatives, legal and insurance claims, scientific committee studies, published literature and media reports. The 'vast majority' of fume events are associated with an abnormal leakage of engine or auxiliary power unit (APU) oil.³ Frequency of exposure to engine oils, are suggested to range from rare and infrequent to frequent with seals leaking as a normal function of their design and operation, whilst oil seals can be reliant upon compressed air for their sealing functionality. However, under-reporting is common and impairment has been reported in around 30% of the reported events. Exposure to a range of hazardous substances and pyrolysis by-products, from engine oils and hydraulic and deicing fluids contaminating the aircraft air supply, is increasingly recognized as potentially adversely impacting flight safety. Despite no real time monitoring to detect compressor bleed air contamination, a growing number of studies have confirmed the presence of low levels of oil substances in the air supply system in normal operations between 25% and 100% of flights. While the significance of exposure continues to be questioned, an increasing number of global initiatives continue to be undertaken.

There are two key ways in which oil leakage outside of the bearing chamber is reported to occur. Outside the specialist engineering and air/oil sealing community, the wider aviation industry community commonly suggests oil leakage occurs only as a result of seal failure or operational deficiencies, such as seal wear or oil overfilling and as such is very rare. The alternative view is that oil seal leakage occurs at low levels during normal phases of flight, indicating that all engines leak low levels of oil from the bearings through the seals during transient power changes and while the engines are still achieving optimum temperatures and pressures. The specialist sealing and engineering community tend to support

the later view, however their views are not commonly reported.

The lower level leakage has generally been viewed as normal and safe, associated with minor discomfort only, with the larger events such as seal bearing failure or wear possibly affecting occupant health or flight safety.⁴

There are clear regulatory standards and guidelines related to the aircraft air quality and differing views as to how the air can become degraded. It was therefore decided to raise a research question addressing oil leakage out of the bearing chamber to determine if this was an occasional maintenance or failure issue or a function of normal engine operation.

The aim of this work was to assess if there is any gap between aircraft certification requirements for the clean air in crew and passenger compartments of transport aircraft using the bleed air system and the theoretical and practical implementation of the requirements.

METHODS

The research consisted of three elements:

1. A review of the certification regulations, standards and guidance/compliance material;
2. Assessment of the documented understanding of bleed air contamination of the aircraft cabin air supply;
3. Research addressing the real-world implementation of the certification requirements requiring clean bleed air.

In order to understand the practical real-world implementation of the requirements using the bleed air system, two separate interview processes were utilized:

1. Semi structured interview undertaken with European Union Aviation Safety Agency (EASA) and Federal Aviation Administration (FAA) airframe and engine/APU airworthiness departments about the process

by which they certify and ensure clean aircraft air requirements are met with the use of bleed air.

2. Semi structured interviews undertaken with ten experienced aviation engineering professionals and two seal supplier experts about their professional judgement on how oil may leak past oil-bearing seals into the air supply under various flight operational conditions.

RESULTS

Key relevant airworthiness certification standards/regulations and guidance/compliance material relate to the following areas. A complete list can be found in the original research.¹

Airframe level

- CS/FAR 25.1309 – Equipment and systems design ‘hazardous’ and ‘major’ failure conditions must be extremely remote and remote respectively under the EU certification standards (CS). The acceptable means of compliance (AMC), are an established way of meeting the CS standards. The AMC establish that ‘hazardous’ failure conditions occur not more than 1×10^{-7} /flight hour (/fh) or a few times during the total life of all the aeroplanes of type. These include failure conditions causing pilots to be unable to be relied upon to perform their jobs accurately or completely or for a few other occupants to sustain serious injury. AMC ‘major’ failure conditions should not occur more than 1×10^{-5} /fh and are unlikely to occur to each aeroplane but may occur several times during the total life of a number of aircraft of type. These include impaired crew efficiency, discomfort to the pilots and physical distress or injuries to other occupants. The US federal aviation regulations (FAR) are little different apart from terminology based on major failure conditions reducing the capability of the crew to cope with adverse conditions to being improbable ($\leq 1 \times 10^{-5}$ – $> 1 \times 10^{-9}$ /fh). Minor or probable failure conditions listed under the EU AMC are those occurring above 1×10^{-5} /fh causing a slight increase in crew workload or some inconvenience to

occupants.

- CS and FAR 25.831 relate to the airworthiness ventilation and heating for the cabin. They require that each crew compartment has enough fresh air enabling crew to perform their duties without undue discomfort or fatigue. The FAR is very similar but requires a sufficient amount of uncontaminated air and references reasonable passenger comfort. Crew and passenger compartments must be free of harmful or hazardous concentrations of gases or vapours. Only carbon monoxide (CO), carbon dioxide (CO₂), ozone (O₃) levels and fresh airflow rates are listed.
- Warning systems must be provided to alert the crew to unsafe system operating conditions and to enable them to take corrective action under FAR and CS 25.1309C.
- An unsafe condition includes events that occur more frequently than the safety objectives allow, or that may reduce the ability of the crew to cope with adverse operating conditions, impair crew efficiency or cause discomfort/injuries to occupants EASA AMC 21. A.3Bb
- There are various other voluntary standards or recommended practices that have been published over the years.

Engine level

- CS E (engine) 510 and CS APU 210 engines and APU safety analysis require that 'hazardous' engine/APU effects are extremely remote, 10^{-7}/engine flight hour (/efh) or APU operating hour (APU o/h) up to 10^{-9}/efh. This includes toxic products in the engine or APU bleed air intended for the cabin sufficient to incapacitate crew or passengers. Degradation of oil leaking into the compressor airflow is listed as such toxic products under the AMC. The safety analysis must include compressor bleed air systems. 'Major' engine/APU effects must not be greater than remote (10^{-5}/efh or APU o/h) under the CS. The AMC 'major effects' includes toxic products in the bleed air sufficient to degrade crew performance. The US FAR, CFR 14 33.75 engine safety analysis

and related guidance material is very similar. A US APU Technical Standing Order (TSO- C77b) requires that failures do not generate an unacceptable concentration of toxic products in the bleed air.

In dealing with such low probabilities, absolute proof is not possible with reliance placed on good engineering judgment, previous experience, sound design & test philosophies.

- CS E-690 requires contamination or purity tests of the bleed air when it is directly used in the cabin and an analysis of defects that could cause this to occur.

Oil sealing

Around 25% of the engine core airflow is extracted and utilized to supply engine internal air and various aircraft systems. This secondary air, also known as bleed air is primarily tapped off the compressor and used for cooling the engine, and accessory components, bearing chamber oil cooling and sealing, control of turbine tip clearances, cavity ventilation bearing load controls, cabin pressurization, ventilation, anti-icing and other services. The extracted secondary/bleed air is controlled and minimized as it reduces power and efficiency of the engine. To do this a number of oil and air seals are required.

A recirculatory oil system provides oil under high pressure for various purposes including lubrication, cooling and sealing. The minimum amount of oil performs these duties taking into account the permissible consumption of oil, usually around 0.1-0.5 US quarts per engine per hour.

Main shaft bearings grouped together in bearing chambers require a continuous supply and removal of oil. Pressurized air from the compressor is used to prevent oil leaking through the bearing seals and to cool and ventilate the bearing sumps. Pressurized air is used to maintain the bearing compartment at a lower pressure than the surroundings, causing an inward flow and preventing an outward leak. Oil seals have various functions including to prevent moisture and dirt entering the chamber, prevent outward leakage of oil (prevents fumes in cabin, fires, loss of performance), control

air leakage in (improves performance) and reduce oil consumption.

There was high awareness of oil contamination of the bleed air supply in the 1950s and early 1960s, however the desire to reduce the costs associated with an extra compressor for the air supply, bleed air was accepted as being of similar quality to outside air. This led to the acceptance of using bleed air to supply the ventilation air required for the cabin.

There are various factors affecting seals. All dynamic seals are designed to leak. How much they leak depends on many factors including the style / type of seal, the hydrodynamic effects; the balance ratio or tooth patterns, the variabilities of the lubricating regime, general operating conditions (speed, temperatures and pressures), wear and distortion.

There are two main types of seals used in aero engines:

Labyrinth seals or non-contacting clearance seals operate with tight clearances. The controlled leakage of air or liquid over restrictions reduces pressure over the seal. Fluid can flow in either direction depending on pressure, momentum and design. Performance deteriorates with time, wear and change in operating conditions, with clearances increasing for example with 'rubs'. Labyrinths are renowned for being low cost and simple.

Mechanical (face, positive contact) carbon seals operate with a micro seal face separation (typically 0.25-1 μm), providing low (non-visible) leakage. The oil film in the face separation is a factor of the hydrodynamics effects acting on the seal, and is a designed compromise between being thick enough to provide lubrication and long seal life, but as thin as possible to minimize leakage. Pressure and temperature distortion during operation can impact the parallelism of the flat seal faces, thereby reducing or increasing leakage. Seal face material condition or surface roughness can influence the oil film condition, while gradual wear of the sealing faces will occur. This type of seal is more complex and expensive.

Common assumptions regarding oil leakage include:

1. Higher pressure in the gas path than in the bearing chamber will keep the oil in the bearing chamber;
2. Seals leak only when a failure occurs;
3. Reverse pressures are to be avoided so as to prevent leakage.

However, oil may flow both with and against the positive pressure gradient with both types of seals. Positive pressure gradients are difficult to attain at near ambient pressures that are used in sealing bearing chambers. Reverse pressures over the seals, unless designed for, allow oil to flow in the opposite direction with both types of seals. Labyrinths operate with a clearance while mechanical face seals allow the face to open up. All dynamic seals will leak, with seals designed to limit leakage or emissions.

Upon closer review, specialist sealing and aero industry awareness of oil seal leakage is well established. Manufacturers have differing views on which seals offer greater advantages and disadvantages, with sealing technology in this industry suggested to not have kept pace with other major engine component advances.⁵ However advancement in sealing technology are being developed, however these styles of conventional seals will be around for a long while.⁶

Research

The following responses were given as a result of the two interview studies undertaken. Full responses can be seen in the original research.⁷

Engineers

- Oil leakage from the bearing chamber can be both internal and external to the engine/APU. Leakage may be a part of the normal oil consumption out via the oil system breather or may enter the core airflow with the potential to enter the cabin bleed air.
- Leakage past the seals can occur as a function of the seal design as they are not an absolute design. Leakage occurs with changing pressure differentials,

thermal, axial and radial (mechanical) changes in engine structures; changes in engine speed and power and design parameters not taking account of all engine conditions. Operational factors such as seal wear, installation and maintenance can also affect leakage.

- Various phases of flight affect leakage such as changes in engine performance- changing pressure differentials and balances over the seals with differing transient engine power, application and ambient conditions affecting seal efficiency and leakage rates; mechanical variations in structures over the engine operating range and low power settings such as start, spool up, top of descent, descent.
- Both carbon face and labyrinth seals leak for varying reasons with some leakage inevitable as it is inherent in the design. Labyrinth seals rely more so on pressure differentials, while mechanical seals require lubrication between the sealing surfaces allowing for leakage across the faces, and are more subject to wear, and are temperature critical. Leakage occurs both with and against the pressure drop with both types of seals.
- There are no specific published limits for oil contamination and there are differing views on when action is required to be taken. Some regard action is required only if oil leakage is above permissible limits, while others regard low level leakage is part of the system design and fails to meet the published design requirements. Regulatory enforcement is regarded as a low priority with available standards ignored.
- Oil leakage is seen in two differing ways: oil leaving the intended areas, loss over the seals or resides in greater amounts than intended. Alternatively, leakage is seen as leakage above the permissible consumption limits and pressure differentials, with lower-level leakage or emissions ignored.
- Under-reporting of oil leakage is generally accepted as occurring.
- Mitigating oil leakage should be given high priority including improved maintenance, better designs, filtration, electric systems and real time monitoring.

Regulators

- With regards to engine/APU certification, there is no specific process that the manufacturers must follow to demonstrate compliance. Bleed air quality compliance under CS E510 and FAR 33.75 addresses hazardous engine effects, including toxic products, such as oil in the bleed air capable of incapacitating crew or passengers at an 'extremely remote' rate of $<10^{-7}$ - $>10^{-9}$ /efh. There are no specific regulatory limits provided, however EASA references SAE recommended practice (4418) as a means to demonstrate compliance. Bleed air purity testing is required under CS E 690 and CS APU 320, however no specific guidance is given, while the FAA lists oil leakage into the compressor airflow as a toxic product, with no further guidance given.
- With regards to the airframe certification, the regulators require enough fresh air or sufficient uncontaminated air to avoid discomfort, fatigue, a minimum airflow, with CO, CO₂ and O₃ considered only. The FAA requires more recent certification programs to address the National Research Council's (NRC) cabin air quality recommendations and to consider a range of other optional standards and guidelines and sources of data to show that incapacitation will not occur. EASA reports there is an interactive process between the regulator and the manufacturers, but provided no details.

DISCUSSION

Regulations, standards and guidance material related to cabin air quality exist which ought to be acceptable in demonstrating compliance. There are however limitations in the descriptive terminology and the presentation of the requirements between the standards and guidance material. This could enable the compliance requirements and AMC to be interpreted in a number of ways or with lesser priority. For example, the engine safety analysis standard refers to toxic products in the bleed air sufficient to incapacitate, while oil leakage into the airflow causing degraded crew performance is listed in the AMC non mandatory guidance material. This may well explain why a lesser focus is placed on oil causing impairment.

The specific details relating to what is considered toxic products sufficient to incapacitate or degrade performance, the air requirements not causing adverse effects or failing to refer to substances other than CO, CO₂ and O₃ and further details on warning systems are absent. This allows room for interpretation and failure to adhere to the standards and guidance material.

There is a clear discrepancy in the understanding of oil contamination of the bleed air supplied to the cabin. The general understanding within and outside the aviation industry, primarily supports leakage due to failed bearing seals, operational factors such as worn seals or overfilled oil reservoirs. There is a less well-known view that oil leaks at background levels as a function of the design using the pressurized bleed air system. The literature involving the seals and aero experts is not widely available, but clearly shows oil leakage at lower levels occurs. Pressurized compressor air is used to seal the bearing compartment, but is responsive to variations in engine operating conditions. Both types of commonly used bearing compartment seals⁷ allow low level oil leakage across the seal, with various operating factors effecting leakage levels further.

The engineering and sealing experts identified a variety of factors allowing low-level oil leakage to enter the compressor air and the bleed air system in normal flight including:

- Changes in pressures and balances during different engine operating and ambient conditions/transient performance changes reduce seal efficiency;
- Thermal, axial and radial changes in engine structures cause changes in gaps needing to be sealed over whole engine operating range;
- Low internal pressures at various phases of engine operation;
- Standards and designs modeled on steady state conditions, not transients;
- Seals are not an absolute design, enabling leakage;
- Seal wear/component degradation.

Based upon the responses given by the engineering and

seals experts and the regulators, there is a discrepancy between the design standards and their implementation using the bleed air system. 'Major' engine/APU effects should not occur greater than remote or 10⁻⁵/efh. Under the guidance material, these include oil leakage into the compressor airflow sufficient to degrade crew performance. The emphasis by the regulators is placed on the regulatory or standard component addressing 'hazardous' effects of toxic products able to cause incapacitation, while almost ignoring the guidance component and major effects. Airframe regulations/standards do not allow failure conditions which reduce the ability of the crew to cope with adverse operating conditions to be more than improbable or 'major'/remote. Under the guidance material, these include impairment to crew efficiency, discomfort to flight crew or physical distress to other occupants and should not be more frequent than 1x10⁻⁵/fh. Such failure conditions may occur several times during the total life of a number of airplanes of type, but unlikely to occur to each airplane. The literature associates the lubricants and their substances with adverse effects.⁸⁻¹⁵ These can be expected to occur more frequently than remotely or improbably (10⁻⁵/ flight hour, engine or APU flight hour), based on 1) the design; 2) hazard recognition under the various chemical databases and literature and 3) frequency reported. Impaired crew efficiency or degraded crew performance can and is expected to occur with exposures. The frequency based on the design meets the definition of 'probable' (10⁻³-10⁻⁵) or above which allow no adverse effects on the flight crew or discomfort to others only through to no effect on flight crew or inconvenience on others only. Exposure to oils via the bleed air system does not meet this. Major effects are expected which must be improbable or remote, yet they are probable and not infrequent.

CS 25.831 requires the air supply to have sufficient fresh or uncontaminated air so as to not cause undue discomfort or fatigue and must be free of harmful or hazardous concentrations of gasses or vapors. However adverse effects are expected and occurring. The regulator emphasis is placed on the ventilation rates and CO, CO₂, while ignoring the discomfort component and

all other chemical substances. More recently, reliance on selected industry actions, studies and standards have been regarded as acceptable means of compliance.

The lack of detection systems and warning indicators to identify oil fumes in flight fails to meet CS/FAR 25.1309C addressing unsafe system operating conditions. There are conflicting views on how low-level oil leakage in normal operations is regarded and it is clear the problem remains unaddressed. However, the system design enabling oil leakage as a part of its function, cannot meet the stipulated airworthiness requirements.

CONCLUSIONS

Low-level leakage of oil fumes containing hazardous and harmful substances occurs in normal flight via the aircraft bleed air supply. Resulting adverse effects are occurring and creating a risk to flight safety. There is a gap between the aircraft certification requirements for the provision of clean air in crew and passenger compartments using the bleed air system and the documented theoretical and practical implementation of the requirements. Key conclusions include:

1. *Regulations and standards:* Low-level oil leakage over the bearing seals into the bleed air is an expected normal condition at various phases of flight. The required bleed air quality is not being met, as the standards and compliance material are not specific enough to ensure suitable bleed air quality, or application. The focus is placed almost entirely on the prevention of incapacitation, while ignoring impairment, with the clean air requirements open to interpretation.
2. *Design:* Although many suggest the certification requirements for clean air supplies are being met, careful review and research shows this not to be the case. Oil leakage past the bearing seals associated with impaired or degraded performance occurs more frequently than the 'major' remote or improbable regulatory and compliance criteria allow. Oil leakage associated with impairment is probable or above and

is an 'unsafe condition.'

3. *Compliance:* The lack of detection systems to identify the air quality in flight causes ongoing compliance problems. Additionally, the ventilation requirements are not specific enough to ensure occupants will remain free of adverse effects.
4. *Preventative control measures:* Low-level and transient oil emissions are not adequately taken into account when considering acceptable leakage levels. The designs are based on steady state conditions, there are no filtration or detection systems to identify and prevent exposure with rigorous controls lacking.
5. *Retrospectively:* Previous certification requirements were not specific enough to prevent oil leakage into the air supply.
6. *Expertise and communication:* Oil contamination of the air supply is a highly specialist area, with inadequate communication between all relevant parties to ensure compliance and airworthiness.

Recommendations

- Review of standards and guidance material;
- Preventative measures: Normal and abnormal operations: detection systems and flight deck warning, filtration.
- Oil leakage not to be related to rare failure conditions or maintenance factors only;
- Frequency of oil leakage explained by design factor;
- Retrospective certification for bleed air quality;
- Future aircraft – Bleed free designs;
- Far greater emphasis placed on the clean air regulator compliance including low-level oil emissions in normal flight.

protocols-for-crews-exposed-to-engine-oil-fumes-on-aircraft/.
Accessed August 31, 2017.

References

1. Michaelis S. Implementation Of The Requirements For The Provision Of Clean Air In Crew And Passenger Compartments Using The Aircraft Bleed Air System. MSc Thesis. 2016. <http://www.susanmichaelis.com/caq.html>. Accessed August 28, 2017.
2. Johnson R, Swickert M, Bisson E. *NACA TN 2846. Effective Lubrication Range for Steel Surfaces Boundary Lubricated at High Sliding Velocities by Various Classes of Synthetic Fluids*. Washington: National Advisory Committee for Aeronautics; 1952.
3. EASA. *A-NPA-2009-10. Cabin Air Quality Onboard Large Aeroplanes*. Cologne: European Aviation Safety Agency; 2009.
4. SAE. *AIR 4766/2- Airborne Chemicals In Aircraft Cabins*. Warrendale: Society of Automotive Engineers; 2005.
5. AGARD. Seal Technology in Gas Turbine Engines. In: *AGARD Conference Proceedings No. 237- Seal Technology In Gas Turbine Engines*. Vol London: NATO-AGARD; 1978.
6. Chupp R, Hendricks R, Lattime S et al. NASA/TM-2006-214341. Sealing In Turbomachinery. NASA. 2006. <http://ntrs.nasa.gov/archive/nasa/casi.ntrs.nasa.gov/20060051674.pdf>. Accessed August 31, 2017.
7. Michaelis S. Implementation Of The Requirements For The Provision Of Clean Air In Crew And Passenger Compartments Using The Aircraft Bleed Air System. 2016. <http://www.susanmichaelis.com/caq.html>. Accessed August 28, 2017.
8. Guerzoni F. *Presentation to SAE E34 Propulsion Lubricants Conference Cardiff, 1999. The Debate Over Aircraft Cabin Air Quality And Health: Implications For Aviation Turbine Lubricants*. Shell Global Solutions; 1999.
9. Boeing. *Boeing MSDS No. 138541. Material Safety Data Sheet- MIL-PRF-23699*. Rev 08/09/2007. Seattle: Boeing; 2007.
10. European Commission. *Regulation (Ec) No 1272/2008 Of The European Parliament And Of The Council Of 16 December 2008 On Classification, Labelling And Packaging Of Substances And Mixtures (CLP)*; 2009. <http://echa.europa.eu/web/guest/information-on-chemicals/cl-inventory-database>.
11. ExxonMobil. Material Safety Data Sheet: Mobil Jet Oil II. *ExxonMobil MSDS*. 2017. <http://www.msds.exxonmobil.com/IntApps/psims/psims.aspx>. Accessed July 31, 2018.
12. ICSC. International Programme On Chemical Safety. 2016. <http://www.who.int/ipcs/publications/icsc/en/>. Accessed August 31, 2017.
13. Michaelis S. Health and Flight Safety Implications from Exposure to Contaminated Air in Aircraft - PhD Thesis. 2010. <http://handle.unsw.edu.au/1959.4/50342>.
14. Michaelis S, Burdon J, Howard C. Aerotoxic Syndrome : a New Occupational Disease ? *Public Heal Panor*. 2017;3(2):198-211.
15. Harrison R, Murawski J, Mcneely E et al. OHRCA: Exposure To Aircraft Bleed Air Contaminants Among Airline Workers - A Guide For Health Care providers. 2009;(April). <http://www.ohrca.org/medical->

GCAQE Meeting Introduction

Margaret of Mar

Countess of Mar
Westminster, England

Corresponding author:
Margaret of Mar
MARM@parliament.uk

KEYWORDS

fume events, care pathway, evidence, legal liability, financial liability, risks

ABBREVIATIONS

CAA Civil Aviation Authority

Welcome everybody.

We are going to have a very good two days—of that I am certain. To start with, today is my birthday. On the basis that it is never too late to learn, I intend to continue with my education; an invitation I extend to so many of the experts upon whom we have to rely to make such important decisions on our behalf.

Firstly, I want to congratulate EasyJet for their momentous decision to test the Pall Aerospace filtration system in their aircraft. I have no doubts that the system will benefit pilots, crew, and passengers, and, of course in the long term, the EasyJet bank balance. I have no doubt the outcome will be successful.

The Sunday Times carried an accompanying announcement by the Civil Aviation Authority (CAA) of a “care pathway” for victims of fume events at a specialist clinic at St Thomas’ Hospital, London, however, this filled me with skepticism. St Thomas’ have form on organophosphate poisoning which doesn’t cover them with glory, but that debate is for another day.

Over the last weeks and months I have been doing a lot of thinking around this conundrum. This has been helped greatly by my meeting with an American bioethicist, Diane O’Leary. One of the advantages of working in a job like mine is that you meet all sorts of wonderfully sharp-minded people. Several of you are in our midst today.

Diane has pointed me in a completely different direction to that assumed by the establishment to be the only one upon which they will act upon our submissions. I think that we will all have to acknowledge that it will be extremely difficult to obtain enough scientific evidence to prove conclusively that the ill health being experienced by some pilots, crew and passengers is the result of exposure to chemically contaminated air in aircraft. It cannot be for want of trying. For the 11 years that I have been patron of GCAQE I have asked hundreds of parliamentary questions for written answer; I have asked oral questions and, with Susan Michaelis and Tristan Loraine, I’ve had meetings with Ministers and members of the CAA. I’ve also written letters to all and sundry. Obfuscation has been the continued objective of officials from the CAA, the Department for Transport, the Health and Safety Executive, the Department of Health and Ministers from those departments.

The recent response from Dr Simon Clarke, Head of the Transport Sector of the Health and Safety Executive, to an invitation to Martin Temple to attend this meeting, is a prime example of the mind-set of the officials. He says: “*We can see nothing in this most recent or previous evidence that provides clear and consistent evidence of causal long-term health effects on air crew related to cabin air quality in line with standard epidemiological and toxicological assessment.*” Clearly, they belong to the ‘closed minds brigade’.

There was a research study conducted by Cranfield University where, perversely, in over 100 test flights, there was not one fume event recorded. Based on the published results of this research, the nearest we have got to any admission is the statement from the Committee on Toxicity of Chemicals in Food and the Environment, also known as the COT, in their

position paper published in 2013. Here they admit that “...uncertainties remain, and a toxic mechanism for symptoms cannot confidently be ruled out.” They suggest that the cost/benefit of further research must be calculated before further research, which they acknowledge is a factor, is commissioned.

Now we get to the kernel of the problem. It strikes me that, no matter how much scientific evidence you provide as to causation, it will never be enough because to admit that there is a problem is also to admit legal and financial liability. We know that the airline operators have a legal responsibility to provide a safe working environment for their employees. We also know that if they can be shown to have failed in their duty there are likely to be claims for compensation.

There is a familiar saying – ‘If you find yourself in a hole, stop digging’. I am suggesting that it is time the manufacturers, the airline operators, the CAA and government to follow EasyJet and stop digging and I will explain why.

The question is this: do the authorities and the airline manufacturers and operators have an ethical duty to act now, given the current state of the difference of opinion about the presence of a problem, or is it all right to continue with the status quo? What does the current state of uncertainty indicate in terms of the right course of action?

One subject upon which we can all agree is the finances. If we acknowledge that the airlines have a great deal of power when it comes to influencing policy decisions of this kind, then we should be able to agree that, if there is a health threat caused by unfiltered cabin air, then concerns about that threat should outweigh concerns about addressing the problem on the basis of scientific evidence. After all, as we have heard in the past, and I know that we will hear again in the next two days, there are relatively inexpensive filters which will do the job.

I believe that there is an obligation to err on the side of caution. We should start by listing all those likely to be

affected: pilots and crew, passengers and ground staff. We should then list the potential harms and benefits to each from delaying action rather than acting promptly. We know that there are both short- and long-term risks of moderate to severe health problems for pilots and crew and that there is a likely short term risk of mild to moderate health problems to passengers. There is also some risk of very serious harm to passengers and crew as a result of poor decision making based on the neurological compromise of the pilots.

Do these risks outweigh the benefits of continuing to research the problem – a process which is necessarily slow because of a lack of funding, before we take action? The only benefits appear to be cost-related; that is costs related to public health efforts, to research and the costs to the airlines. There is a great benefit to caution. If, as the airline operators, the CAA and government claim, there is no problem with cabin air at all, then researching the problem slowly allows us to get a very clear picture of the details before acting in a way that is rash and unsupported.

I will give you an example. We have one flight, pilots, crew and a set of passengers. As the flight is about to take off, we discover that there is an unclear level of risk of air contamination. It might be contaminated to the extent that would compromise the pilot’s decision making. It might pose a short-term health risk for passengers and crew. Perhaps continued exposure would pose long term health risks to the pilot and crew. It might pose a lifelong risk to an unborn fetus. Would it be ethical to let that flight take off without immediately looking into the problem?

It seems not. If we become aware of this kind of potential threat at exactly this level of certainty for any particular flight before take-off, I am sure that we would all recognize that the flight should not be allowed to take off until we can make sure the air is safe to breathe. When the problem applies to a particular group of human beings we can see readily the need to respond to uncertainty in a protective way.

It looks simple to me. The benefits of acting now, for the sake of caution, far outweigh the benefits of acting slowly. What is the ethical response to uncertainty in this case? Is it acceptable to respond to uncertainty by allowing the risk to persist, or is there an ethical obligation to respond to uncertainty in a protective way that errs on the side of caution? Sometimes it is hard to see the answer to the question at the level of patient groups and policy when it is generally easy to see at the level of individuals. It is then that we can assume that the same obligations hold at the level of policy.

Perhaps we are blinding ourselves with the obsession for science.

Hair Analysis: An Innovative Biomonitoring Tool to Assess Human Exposure to Tri-Cresyl-Phosphate (TCP)

Vincent Peynet

Institut de Recherche et d'Expertise Scientifique (IRES), Strasbourg, France

Corresponding author:
Vincent Peynet
contact@ires-lab.com

ABBREVIATIONS

TCP Tri-Cresyl-Phosphate

ABSTRACT

Organophosphate flame retardants, especially Tri-Cresyl-Phosphate (TCP), are found in aircraft cabin air. They are strongly suspected to be related with aerotoxic syndrome that affects aircraft crews. Exposure information is stored in hair structure during hair synthesis and therefore hair matrix is a powerful biomonitoring tool to assess human exposure to xenobiotics over several months.

Analytical protocol was developed and validated to accurately measure level of 5 TCP isomers in hair matrix. The method was applied to investigate TCP exposure of crew members (N=46) and non-crew control group (N=35). A threshold value is proposed to attest for over-exposure to TCP.

INTRODUCTION

A recent study performed by EASA to assess cabin air quality demonstrated contamination by many organic compounds.¹ Among cabin air pollutants, organophosphate flame retardants were measured at significant levels in the air. Due to their well-known neurotoxicity, they are strongly suspected to be related to aerotoxic syndrome that affects aircraft crews. Beside Tri-Butyl-Phosphate (TBP, CAS 126-73-8), Tri-Phenyl-Phosphate (TPP, CAS 115-86-6) and Tri-Chloro-iso-Propyl-Phosphate (TCPP, CAS 13674-84-5) that are widely used in furniture and plastic, specific forms of

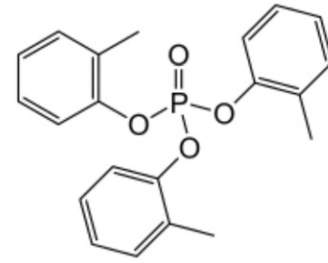
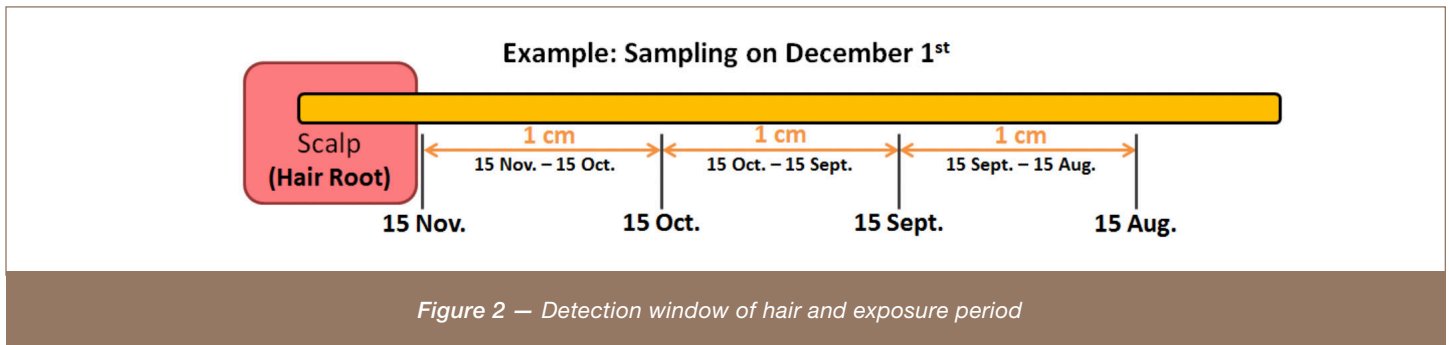

Figure 1—Chemical formula for Tri-ooo-Cresyl-Phosphate isomer

Tri-Cresyl-Phosphate (TCP) are used in Mobil Jet Oil II, the most widely used aircraft oil. Symptoms of aerotoxic syndrome are reported to occur after a fume event when air cabin is contaminated with oil residues and acutely expose aircraft crew and passengers to highly toxic substances that are in the oils. Initially, Mobil Jet Oil II contained higher levels of the TCP ortho isomers (Figure 1) than currently present in the TCP formulation used today. The reduction in the ortho isomer content was in part due to concerns being raised about its toxicity in relation to Organophosphate-induced delayed neuropathy (OPIDN). TCP composition of Mobil Jet Oil II was accurately determined in the work of Megson in 2016 and established the presence of 4 TCP isomers (3 - 5%): TmmmCP, TmmpCP, TmppCP, TpppCP with a specific ratio pattern.² The same kind of pattern was found in EASA Air Cabin contamination Study.

Blood and urine are considered as reference matrices for the biomonitoring of exposure to xenobiotics. However, their detection windows are very limited and biological samples need to be taken quickly after exposure: few hours for blood and a day for urine. Moreover, sampling blood requires medical assistance (venepuncture), blood and urine need to be frozen (-18°C or -60°C) and keep frozen during transport to the laboratory. As they are still “active” biological matrices, analysis should be done as soon as possible to avoid any degradation of the xenobiotic with high biohazard risk (Virus, HIV, hepatitis) for laboratory personnel. These limitations make blood and urine not suitable matrices for easy and user-friendly



biomonitoring tool.

As an alternative biological matrix, hair has been widely used for several decades to assess human exposure to alcohol, drug of abuse and environmental contaminants (persistent organic pollutant, pesticides...).³⁻⁵ Hair growth rate is about 1 cm per month. Hair root is irrigated with blood vessels. During hair synthesis in the scalp, xenobiotic present in blood stream incorporate the internal structure of hair. Compared to blood and urine, hairs are easier to sample, to ship (less than 20g with envelop and sampling form, ambient temperature) and to store (+5°C / -18°C, limited space needed). Moreover, exposure information stored in hair is very stable over time and analysis of 1 cm hair length is used to assess the average exposure over 1-month period (*Figure 2*). Even if the relationship between concentration found in hair and the average exposed dose cannot be obtained for humans, quantity measured in hair reflect the intensity of exposure and people with highest concentration are assumed to be more exposed. Study performed on rats demonstrated such relationship and can be reasonably assumed for human.⁶

IRES laboratory developed sampling procedure, collection kit and analysis protocol for the determination of TCP in hair to attest for exposure. Briefly, hair strand is cut to keep the first 3 cm of proximal (closest to the scalp) or specific segment length. Selected hair segment are washed to remove potential external contamination (environmental surface contamination) and grinded to get a fine powder. Accurate mass of hair's powder is extracted with organic solvents and the extract is analysed with gas

chromatography coupled with tandem mass spectrometry detector (GC-MSMS). In terms of performance, five isomers of TCP (ToooCP, TmmmCP, TmmpCP, TmppCP and TpppCP) are measured in hair; the method has a limit of quantification (LoQ) of 2 pg/mg of hair and uncertainty ranging from 25% at LoQ and 20% at higher level.

A measurement campaign was performed to validate the protocol with real samples and obtain statistical information about TCP residues for crew members (N=46) and non-crew control group (N = 35). Results (*Figure 3*) attested exposure to at least one TCP isomer for more than 1 person out of 2 (53.2% for TmmpCP isomer) and TCP isomers found in Mobil Jet Oil II have the highest occurrences. Lowest occurrence was found for ToooCP (15.5%).

Due to small number of subjects (N = 81), only limited statistical interpretation were made. For data analysis, subjects with highest exposure level (highest concentration) were excluded using Grubb's test. Less than 5% samples (N = 4, 3 from Crew group and 1 from non-crew group) were excluded.

There are no significant difference between the two groups regarding occurrence and exposure level. Results obtained for non-crew group population strongly suggest environmental exposure to TCP and need to be investigated further in particular to determine the origin of exposure as TCP is not a flame retardant commonly used in domestic goods.

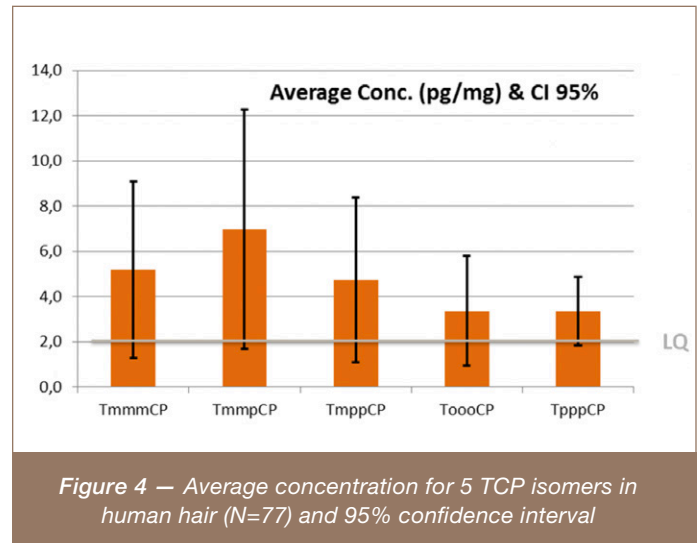
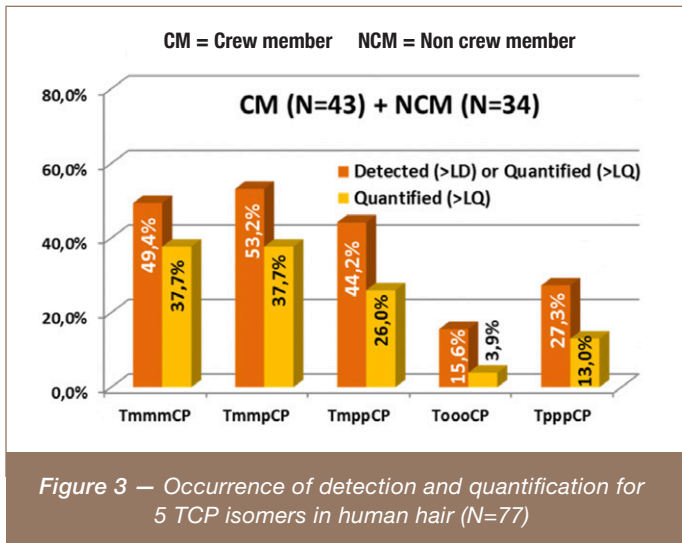

The TCP isomers pattern observed Mobil Jet Oil II is very close to the pattern found for occurrence ratio and average hair concentration (N = 77). This observation demonstrates with high probability human exposure to Mobil Jet Oil II.

Based on average concentration level and standard deviation, a threshold value was calculated with 95% confidence to attest for over-exposure to TCP. Hair taken from wife or husband (non-crew) of over exposed crew (N = 2) were tested for TCP over the same time period and no TCP was found. Difference observed strongly suggests occupational exposure to Mobil Jet II oil residues.

A sampling procedure and sensitive, accurate and reliable analytical protocol were successfully developed and validated for field investigation and promise to be a powerful biomonitoring tool for large scale campaign to search for correlation between TCP exposure and aerotoxic syndrome pathologies. Complete home testing kits are now available worldwide to assess human exposure to TCP.

Acknowledgment

This work was financially supported by AVSA (Association des Victimes du Syndrome Aérotoxique). www.syndrome-aerotoxique.com

References

1. EASA. *Research Project : CAQ Preliminary Cabin Air Quality Measurement Campaign. Final Report EASA_REP_RESEA_2014_4*. Cologne: European Aviation Safety Agency; 2017. https://www.easa.europa.eu/system/files/dfu/EASA_CAQ_Study_Final_Report_21.03.2017.pdf.
2. Megson D, Ortiz X, Jobst KJ, Reiner EJ, Mulder MFA, Balouet J-C. A comparison of fresh and used aircraft oil for the identification of toxic substances linked to aerotoxic syndrome. *Chemosphere*. 2016;158:116-123. doi:10.1016/j.chemosphere.2016.05.062
3. Auwarter V, Sporkert F, Hartwig S, Pragst F, Vater H, Diefenbacher A. Fatty acid ethyl esters in hair as markers of alcohol consumption. Segmental hair analysis of alcoholics, social drinkers, and teetotalers. *Clin Chem*. 2001;47(12):2114-2123.
4. Cooper GAA, Kronstrand R, Kintz P. Society of Hair Testing guidelines for drug testing in hair. *Forensic Sci Int*. 2012;218(1):20-24. doi:<https://doi.org/10.1016/j.forsciint.2011.10.024>
5. Covaci A, Tutudaki M, Tsatsakis AM, Schepens P. Hair analysis: another approach for the assessment of human exposure to selected persistent organochlorine pollutants. *Chemosphere*. 2002;46(3):413-418.
6. Appenzeller BMR, Hardy EM, Grova N, et al. Hair analysis for the biomonitoring of pesticide exposure: comparison with blood and urine in a rat model. *Arch Toxicol*. 2017;91(8):2813-2825. doi:10.1007/s00204-016-1910-9

Moving Towards Total Cabin Filtration: Realtime Monitoring

Chris Savage, Stephen Simpson, Paul Roux

Pall Corporation, New Port Richey, USA

Corresponding author:

Chris Savage

christopher_savage@europe.pall.com

KEYWORDS

air quality sensors, fume events, cabin air, contaminants, volatile organic compounds

ABBREVIATIONS

VOC Volatile organic compounds

ABSTRACT

It is difficult for airline crews to identify odors that cause expensive delays and unscheduled maintenance. The Pall Cabin Air Quality Sensor (CAQS) identifies the source of an odor by utilizing aerospace qualified microelectronics technology, enabling focused maintenance, increasing up-time and reducing cost.

INTRODUCTION

Pall has been serving the aerospace industry for over 70 years with innovative, enabling products. Pall was the first company to develop and introduce hospital-grade (H14) HEPA filters in the aircraft cabin air recirculation line and Pall Aerospace now proudly leads the way in the development and introduction of sensors that will identify contaminants present in the cabin that have been introduced in the fresh air supply.

Statistics show that about a third of delays are due to events not associated with weather or air traffic control (ATC). These delays include fume events, where noxious odors are detected in the cockpit or passenger cabin and whilst it is recognized that fume events happen infrequently, it can be difficult to identify the source which can lead to significant maintenance activities and the aircraft being out of operation.

The frequency of reported air quality incidents has increased over the years and this increase is due not to age-related deteriorating aircraft performance but more to an increased awareness of cabin air quality among flight crew and passengers and also improved crew training related to reporting procedures for fume events.¹

While volatile organic compounds (VOCs) are generated from many sources, including sources inside the cabin, the VOCs from engine fluids, primarily lube oils, create the most concerns in the industry. These VOCs can stem from oil leaking past seals into the hot engine bleed air. The vaporization, partial oxidation, or combustion of that oil creates VOCs, some of which are or can become toxic.^{2,3} Since engine bleed air is used for the fresh air supply, these VOCs can then enter the cabin and cockpit. Fume events are disruptive because identifying an errant smell is time consuming and crew members are not always able to detect the source. According to a report by the German BFU, 65% of all odors reported in the cabin are unknown or not determined, therefore a sensor that can confirm if the odor emanated from the fresh air supply or not would be a very valuable tool in facilitating the maintenance activities and returning the aircraft to service in a shorter space of time.

Cabin air quality sensor

Boston Micro Systems, a division of Pall Aerospace have developed a MEMS (Micro Electro Mechanical Systems) based sensor that is capable of identifying selected VOCs that are present in the aircraft cabin. Pall have demonstrated the sensor's capability in the laboratory and are now manufacturing advanced prototypes which will be available for flight trials.

The sensor is designed to meet the following aims:

- Improves efficiency of maintenance activities by enabling rapid location of failures
- Enables predictive maintenance (identifying trend of VOC levels in line with impending failures)
- Enables pilot decision to fly post fume event (without the need for aircraft maintenance or engineers to inspect prior to flight)
- Ensures a pro-active approach by improving overall cabin air quality for crew and passengers

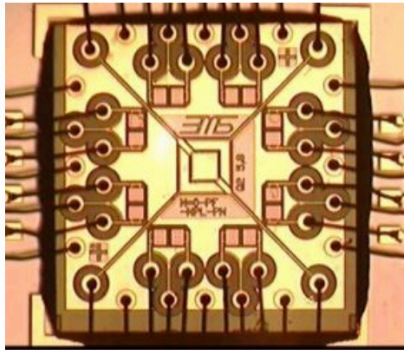

Figure 1 — The sensor module

The technologies on which the sensors are built are well proven and are used in such well known and established products such as mobile telephones. Pall's MEMS division originally took this core technology and adapted it to enable the detection of moisture in the semiconductor fabrication process gasses to concentrations as low as parts per trillion (PPT), this is necessary to ensure a high manufacture yield. The technology was further developed to enable the detection of explosive compounds which then evolved to detection of cabin air contaminants.

Operating principle

The sensor is an electronic nose; this means that it enables identification of complex mixes of compounds (such as those that form "burnt oil") rather than specific molecules (e.g. toluene). The sensor module, which is no more than 2.3 mm square (Figure 1), is comprised of eight individual sensors. Each sensor has two layers: 1) a pre concentrator which collects the contaminants from the air stream and 2) the resonating layer which generates the responses from which the contaminants can be deduced (Figure 2). The contaminants are released from the pre concentrator with a periodic flash of heat. The released contaminants then interact with the chemo-selective coating on the sensor downstream and the contaminant "smell" is identified by factors such as the change in the sensor resonance (Figure 3).

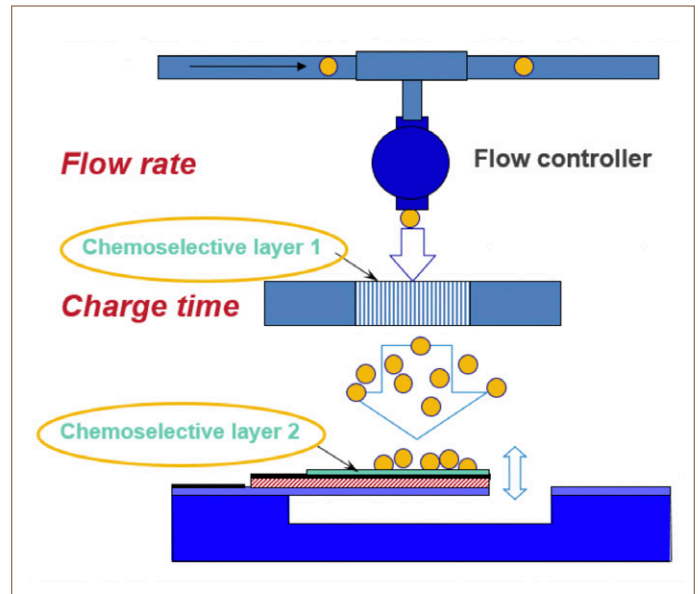

Figure 2 — The resonating layer

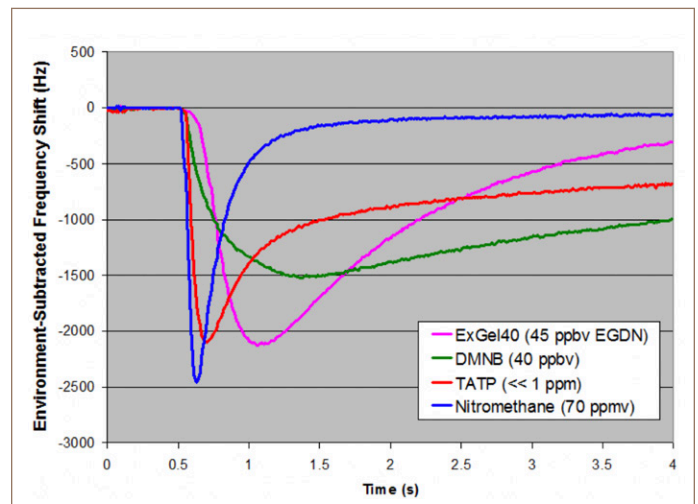

Figure 3 — Identification of contaminants

These properties are then used to generate pattern recognition algorithms which enable accurate identification of the fluid in multi-dimensional feature space. Figure 4 shows the increase in resolution that occurs when just moving from 2D to 3D feature space. Specifically, two sensors alone are not enough to

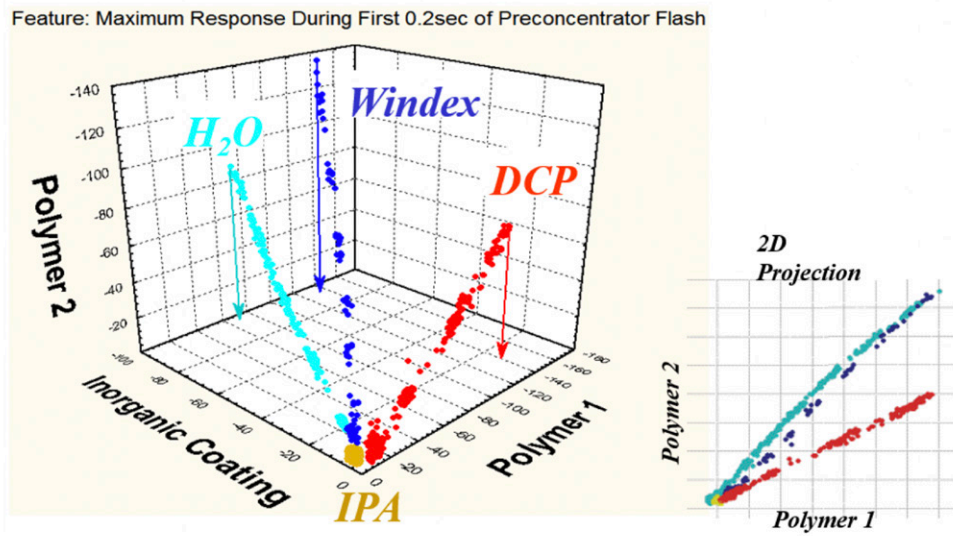

Figure 4 — Increase in resolution moving from 2D to 3D

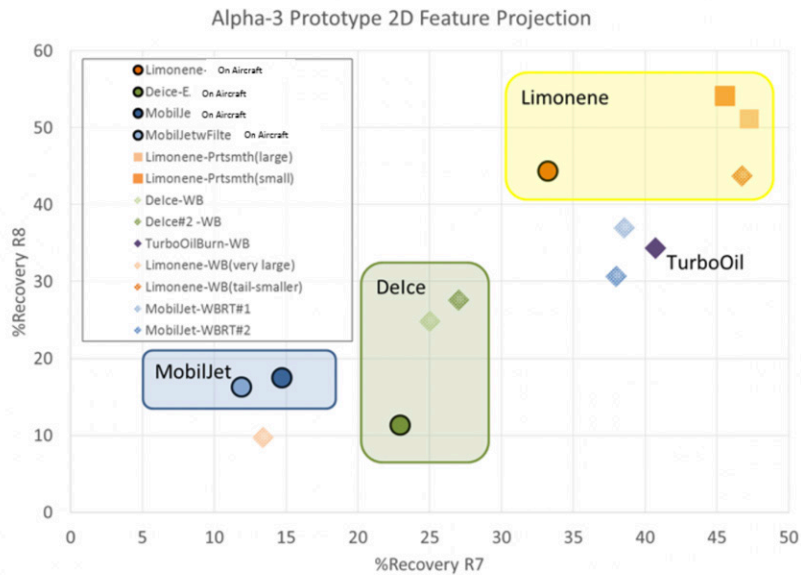

Figure 5 — Identification of contaminants

discriminate water and Windex while the distinction is immediately clear when just one more sensor is added to the detection array.

This same approach has been used in detecting the target fluids in the cabin air during ground-based testing on an A320 and Figure 5 demonstrates that the sensor uniquely identifies the contaminants even in 2D and the differentiation will be further enhanced when the pattern recognition algorithms are finalized.

Pall are still in the process of defining the fingerprint of the normal cabin air environment to establish a generic profile (pattern) so that any deviations from this can be reliably identified so the sensor will not register a fume or smell event when it is actually a change in the background and part of a normal flight profile. Mark 1 production sensors will be manufactured in Q1, 2019 and these will further characterize the cabin air.

References

1. BFU. *BFU 803.1-14. Study Of Reported Occurrences In Conjunction With Cabin Air Quality In Transport Aircraft*. Braunschweig: Bundesstelle für Flugunfalluntersuchung; 2014.
2. Eastman Aviation Solutions. Skydrol SDS. <https://www.eastman.com/Brands/EAS/Skydrol/Pages/Home.aspx>.
3. ExxonMobile. Material Safety Data Sheets. <https://www.msds.exxonmobil.com/IntApps/psims/psims.aspx>.

Aircraft Cabin Air and Engine Oil— An Engineering View

Dieter Scholz

Hamburg University of Applied Sciences, Hamburg, Germany

Corresponding author:

Dieter Scholz

info@profscholz.de

KEYWORDS

aeronautics, airplanes, aircraft, aerospace engineering, turbofan engine, aircraft cabins, cabin air, passenger, oil, air conditioning, bleed air

ABBREVIATIONS

CO	Carbon monoxide
L/D	Lift to drag ratio
VOC	Volatile organic compounds

ABSTRACT

Almost all passenger jet aircraft today use potentially contaminated bleed air for cabin ventilation. A detailed look at the design of engine bearings, their lubrication and sealing reveals that jet engines leak small amounts of oil by design and not only in failure cases. An equation is derived to calculate the concentration of a possible cabin air contamination. Results show good agreement with measured concentrations of hydrocarbons in aircraft cabins under normal conditions. The solution to the problem of cabin air contamination is a bleed free design. Other partial remedies are briefly discussed.

INTRODUCTION

Passengers like short trip time, but even more they demand inexpensive tickets, which are only possible at aircraft costs low enough to allow for airline profits. Aircraft must have a price sufficiently high to allow for aircraft manufacturer profits. If aircraft fly fast, their productivity is high and their price depreciated each year is shared among more passengers. Also fuel costs have to be low. Therefore, drag has to be low, and thrust to

overcome drag has to be produced efficiently.

The aerodynamic efficiency of an aircraft is expressed with the lift to drag ratio (L/D). L/D is called glide ratio. In cruise, aircraft lift equals aircraft weight, and drag is low when L/D is high. The *maximum* glide ratio is independent of density and as such altitude. However, a favorable *actual* glide ratio depends on a favorable (medium) lift coefficient. As we have seen, cruise speed needs to be high (but should be below the speed of sound for economic and legal reasons). This means that (at given wing area selected for approach and landing) optimum aircraft performance requires flight at low density (high altitude) to achieve the favorable lift coefficient. When flying at high cruise altitude (≈ 11 km), engines will have lost much of their thrust due to the low density. This has to be compensated during aircraft design with a larger (heavier) engine. This drawback is only partially compensated by the lower temperatures at altitude that make the engine a little more efficient.

At cruise altitude humans cannot survive. This is due to the atmospheric pressure which is only 20% of that at sea level and as such much too low for breathing. The low atmospheric temperature adds to the problem. For obvious comfort reasons, passengers are not asked to wear an oxygen mask throughout the flight. Instead the cabin is pressurized to a sufficient 74% of sea level pressure (which is equivalent to an altitude of 8000 ft).

A jet engine consists of a compressor, a combustion chamber and a turbine. Since the 1950s, outside air is brought to the higher pressure required for the cabin by means of the engine's compressor of passenger jets. Air is simply taken away from within the compressor. This air is called bleed air. A separate compressor could be used, but a compressor already in place does not add costs and hence does not add to the aircraft's price. Why and how much cabin air can potentially be contaminated by bleed air is discussed in this paper.

In summary, the potential problem of contaminated cabin air is due to financial reasons:

1. To be economic, aircraft have to fly fast and hence high. This requires pressurizing the cabin.
2. For inexpensive cabin pressurization, engine compressors on each engine are used. The engine compressor is an available commodity. Any other design consists of more components and is therefore more expensive.

Air conditioning

Air conditioning in aviation means temperature control, pressure control and ventilation.¹

The cabin is vented with a certain percentage (e.g. 50%) of fresh outside air. CS-25.831 details how much fresh air is required for each passenger and pilot – in normal case and in failure cases.² The remaining part of the air for cabin ventilation is provided as air from the cabin itself – filtered and recirculated back into the cabin. Recirculating cabin air gives additional ventilation (beyond certification requirements) without the need of new (expensive) compression. In addition, recirculated air contains some passenger exhaled humidity – much in contrast to ambient air, which is almost dry at cruise altitude.

If outside air is compressed only up to cabin pressure (753 hPa) – which means setting the cabin to an equivalent maximum allowed altitude of 8000 ft (CS-25.841) – it will have about 70°C. This is more than the typical 21°C in a cabin and needs cooling. Cooling is done in the air conditioning system with further compression, with heat exchange to the environment and with expansion to regain at least some energy in a so-called air cycle process. At the heart of this process is the air cycle machine, consisting of a compressor coupled to a turbine. Traditionally, the process runs on energy taken with even higher bleed air pressure (more than 3000 hPa) from the engine compressor. This results in air temperatures reaching 400°C or more. Hence, bleed air cooling is even more paramount. Clearly, any cooling means dumping heat overboard and results in a low efficiency of the process.

Alternative (electric) cabin air cooling compresses air

to only 753 hPa (8000 ft cabin altitude) or for additional comfort to 812 hPa (only 6000 ft cabin altitude). The reduced compression saves about 1 kW per passenger.³ A separate compressor is used with oil-free air bearings. The air is taken directly from the outside via air inlets on the fuselage. The air cycle machine is powered by electric motors. The electricity comes from generators connected to the aircraft's engines.⁴ Shaft power to drive the generators can be obtained from an aircraft engine with an efficiency of amazing 70%.⁵ This is due to the fact that shaft power off-takes increase the engine's turbine inlet temperature towards the design maximum and hence increase the efficiency of the engine while producing thrust. Shaft power off-takes are about twice as efficient compared to bleed air extraction. An electric air conditioning system can be economical at a high fuel price because it trades higher depreciation (from a higher aircraft price due to more components) against reduced fuel costs. The described alternative air conditioning solution flies today only on the Boeing 787. Airbus could follow. The technology is already available at Airbus and was checked in test flights. As of today, Airbus is still undecided about a bleed versus a no-bleed decision for an air conditioning system of a possible all-new aircraft.

Engine seals and oil

The engine shafts are supported by lubricated bearings. They are sealed against the air in the compressor often with labyrinth seals. Subsequently, it will be explained why these jet engine seals leak oil by design in small quantities. Leakage of carbon seals is only 10% of the amount experienced with labyrinth seals.⁶ However, leakage should not occur – no matter how small – because the oil contains problematic additives. Three percent of the engine oil usually consists of tricresylphosphate (TCP). Some TCP isomers are known for causing nervous system effects among other symptoms. The oil gets pyrolyzed (chemically modified) at the elevated temperatures in the compressor, leaving more than 100 substances behind, some of them are hazardous and among them are various Volatile Organic Compounds (VOC).⁷

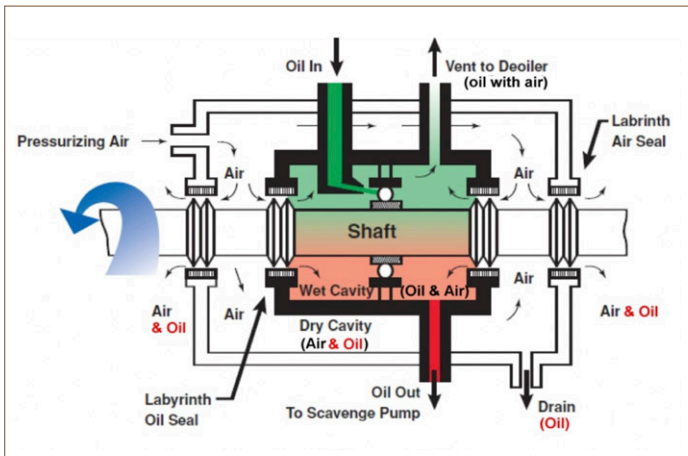

Figure 1— Typical bearing lubrication and sealing in a jet engine. The Figure is based on Exxon (2017).⁸ Shown is a double walled seal design.

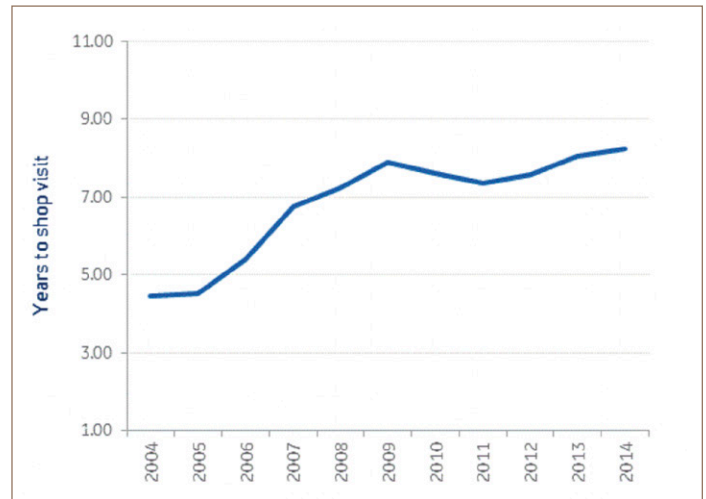

Figure 2 — CFM56-7B Time to first shop visit.¹⁰

Labyrinth seals require bleed air going from the dry cavity to the wet cavity. The airflow should keep the oil back, which has a normal tendency to scatter and to flow out of the wet cavity (through the seal in the inner wall). As can be expected, the air cannot fully keep the oil back from flowing into the (so called) “dry cavity”. This is indicated in Figure 1 by an (oil) drain. The oil drain allows the “dry cavity” to be continuously emptied from accumulating oil. Now that it is understood that the “dry cavity” contains some oil, it is also clear that the air flowing through the seal in the outer wall (from inside towards the outside) will carry some oil out into the engine compressor. In the engine compressor the oil mixes with compressed air, of which a small portion is bled off into the cabin. When only a single wall design is used, air and oil leak directly through the seal into the compressor.

Smaller clearances in the seal require less air flow, but eccentricity and relative movement between components requires designing the seal with some minimum clearance. If clearances are too small labyrinth seals can be damaged. For a given clearance, sealing will be better with larger air flow, but pressurized air comes at a cost due to increased fuel consumption and therefore air flow will be limited.

“Labyrinth-seal clearances naturally increase as an engine ages. As this occurs – due to rubbing under vibration, gyroscopic torque, rough landings or any g-load factor, the engine air flow increases, resulting in even higher oil consumption” and hence leakage into the bleed air.⁶ In addition, during a period of 10 years (2004 to 2014) maintenance practice changed such that engines stay on the wing almost twice as long without shop visit and seal replacement (Figure 2). This means that the aviation industry accepts increasingly higher oil leakage and as such higher contamination levels in the cabin. Once again we are back to economics. For other aspects of jet engine seal design and operation see also Michaelis (2016).⁹

An alternative source for the compressed air is the Auxiliary Power Unit (APU). Like the aircraft’s jet engine, it is a gas turbine, built much in the same way when it comes to bearings and seals. For this reason, also compressed air from the APU is potentially contaminated.

Engineering standards from SAE contain guidance about sound engineering design principles for air conditioning systems of air planes.³ Also certification standards give some guidance, however, more general. In essence,

bleed air systems used to supply the air conditioning system as we see them on today's passenger jet aircraft should not be built the way they are.

Cabin air and oil

The amount of oil leakage and the resulting concentration of pyrolyzed engine oil in the cabin air can be estimated from first principles. These are the steps, thoughts and example parameters:

- Oil is mixed with air in the bearing chamber (Figure 1). If this mixture would be vented, the oil consumption would be extraordinary. In order to retain most of the oil, an air/oil separator also called deoiler or deaerator is used. The device separates air and oil with rotation and centrifugal force. Nevertheless, some oil escapes with the vented air overboard.
- All calculations are done for the whole aircraft.
- Consider the number of engines: $n_{eng} = 2$
- Determine the engine oil consumption per flight hour from airline maintenance records: \dot{m}_{oil}
- Oil consumption is a minimum of 0.3 l/h per engine. Here two engines: $\dot{V}_{oil} = 0.6$ l/h
- $\dot{m}_{oil} = 0.1673$ g/s with an oil density of 1.0035 kg/l
- Estimate the ratio of oil out of all seals versus the total oil out (including especially that oil leaving the air/oil separator, also called deoiler or deaerator): $x_{seal} = 1\%$ (conservative estimate)
- Determine number of all bearings or seals: $n_{bear} = 5$ (CFM56)
- Determine number of bearings or seals upstream of first bleed port: $n_{bear,up} = 3$ (CFM56)
- Calculate upstream bearing ratio:

$$x_{bear,up} = n_{bear,up} / n_{bear} = 3/5 = 0.6$$

- Get the Bypass Ratio (BPR) of the engine: $\mu = 5.7$ (CFM56-5B1)
- Get engine frontal area from engine inlet diameter or fan diameter: $S_{eng} = \frac{4}{\pi} D_{eng}^2$, $D_{eng} = 1,73$ m
- Get aircraft cruise Mach number: $M_{CR} = 0.76$ (A321)
- Get aircraft cruise altitude: $h_{CR} = 11$ km
- Get speed of sound at cruise altitude (from ISA Table or calculated): $a(h_{CR}) = 295$ m/s
- Get density at cruise altitude: $\rho_{CR} = 0.364$ kg/m³ and in the cabin (at 8000 ft): $\rho_{cab} = 0.963$ kg/m³
- The steady state oil concentration in the cabin is equal to the oil concentration of the inflow.
- Finally, we have the equation of the oil concentration in the cabin (derivation in Scholz 2017³):

$$\frac{m_{oil,cab}}{V_{cab}} = \frac{\dot{m}_{oil} x_{bear,up} x_{seal}}{S_{eng} n_{eng} M_{CR} a(h_{CR})} \cdot \frac{\rho_{cab}}{\rho_{CR}} (1 + \mu)$$

with sample data: $\frac{m_{oil,cab}}{V_{cab}} = 17$ µg/m³

The estimate shows the same order of magnitude as measured in flight (Figure 3).

Cranfield and EASA measurements (Figure 3) are not very conclusive when looking for the amount of pyrolyzed oil concentrations (hydrocarbons) in the cabin. However, when asking only for the order of magnitude this is found: A concentration of about 10 µg/m³ could be considered as background reading present in the cabin and is e.g. due to emissions of VOCs from cabin items and flame retardants. Another 10 µg/m³ ... 20 µg/m³ of hydrocarbons may be explained by oil leaking into the cabin through engine seals.

Solutions to the problem

The problem can only be solved fully by avoiding bleed air for aircraft air conditioning and to select an alternative air conditioning system with a direct intake of ambient

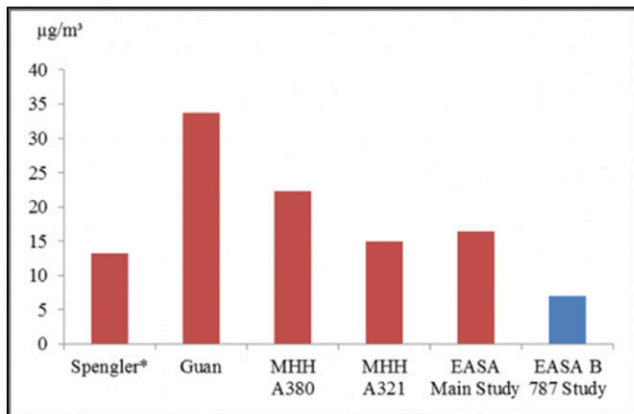

a

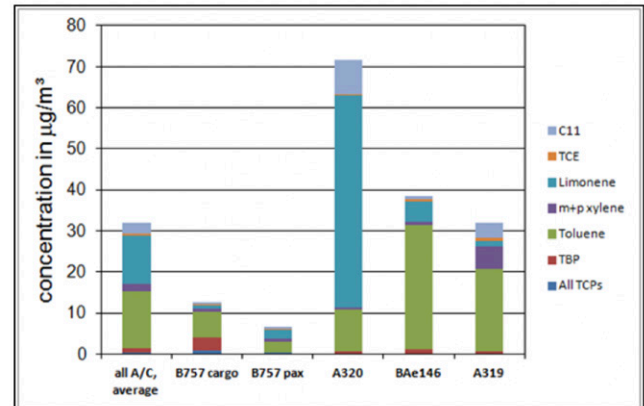

b

Figures 3a & b — Left: Sum of aromatic hydrocarbons. Comparison of different studies (median). In-flight measurements. Highest values from three investigated airlines.¹¹ The 10 µg/m³ measured in case of the 787 could be considered background reading from cabin items like furniture that also emit VOCs. Right: Sum of the concentration of measured VOCs. Note: Also other VOCs could have been present, but are not given in the study. Therefore: Sum of VOC concentration could be higher than shown.¹²

air (see section ‘Air conditioning’). The second-best solution is complete cabin air filtration with carbon filters in the supply ducts from the engine. It reduces the concentration of whatever contamination by 80%. Technically the easiest way to install carbon filters to filter VOCs in existing aircraft is in the recirculation path, where HEPA filters are already in use. Unfortunately, air filtration only in the recirculation path is less efficient. It reduces the concentration of whatever contamination by 40%.³

Immediate action should be taken without waiting for the ultimate industry solution of the problem which may not come. Individuals can do something about detection and avoidance. This is especially important during cabin air contamination events (CACE). CACE that manifest themselves as smell event of fume events can be detected by human senses (nose and eyes). Other contaminations may pass unnoticed. For this reason, pilots (or crew in general) should read the carbon monoxide (CO) concentration from a personal CO detector as an objective indicator in addition to the observations from their senses. A measured CO

concentration will always be low. Therefore, it should be compared not against the limit value of 50 ppm (CS 25.831) but rather against values obtained under normal conditions (e.g. 2 ppm). If pilots are alerted of a cabin air contamination and systematic trouble shooting has been done without improvement to the cabin air, pilots should consider to descend to 10000 ft, reduce speed and ventilate the aircraft by means of the ram air inlet (if fuel reserves and terrain clearance allow for it). The ram air inlet is the only source of fresh air in flight, independent of engines or APU. If smoke is present, checklists tell pilots to put on their oxygen mask. In such a case, also cabin crew should consider wearing a personal breathing mask protecting against nerve gas.³

CONCLUSIONS

Aircraft engine seals leak oil by design in small amounts. This already follows from looking at the design of bearing and seals. An equation was derived to calculate the concentration of a possible cabin air contamination. The seal leak ratio may be set to 1% as long as no better values are available. If a certain oil consumption

(given in l/h) is considered troublesome on one aircraft, it may not be considered likewise on another aircraft, which has other parameters of size, BPR and bearing positions relative to bleed ports. Hence, the equation from this paper may be used to compare oil consumption of different aircraft with respect to their cabin air contamination potential. This could be the topic of further research activities.

time-wing-advan. Published 2016.

11. EASA. *Comment Response Document (CRD) To Advance Notice Of Proposed Amendment (A-NPA) 2009-10 - Cabin Air Quality Onboard Large Aeroplanes*. Cologne: European Aviation Safety Agency; 2011. [https://www.easa.europa.eu/system/files/dfu/CRD to A-NPA 2009-10.pdf](https://www.easa.europa.eu/system/files/dfu/CRD%20to%20A-NPA%202009-10.pdf).

12. Crump D, Harrison P, Walton C. *Aircraft Cabin Air Sampling Study; Part 1 and 2 of The Final Report: Cranfield*. Cranfield: Institute of Environment and Health, Cranfield University; 2011. <http://dspace.lib.cranfield.ac.uk/handle/1826/5305>

References

- 1.** SCHOLZ D. Aircraft Systems. In: PLATZER M, AGRAWAL B, eds. *Standard Handbook for Aerospace Engineers*. New York: McGraw-Hill and SAE International; 2018.
- 2.** European Aviation Safety Agency. Certification Specifications and Acceptable Means of Compliance for Large Aeroplanes – CS-25. <https://www.easa.europa.eu/certification-specifications/cs-25-large-aeroplanes>. Published 2017.
- 3.** SCHOLZ D. Aircraft Cabin Air and Engine Oil – An Engineering View. In: *International Aircraft Cabin Air Conference 2017*. ; 2017. <http://CabinAir.ProfScholz.de>
- 4.** SINNETT M. No-Bleed Systems: Saving Fuel and Enhancing Operational Efficiencies. *Boeing AERO Mag*. 2007. http://www.boeing.com/commercial/aeromagazine/articles/qtr_4_07/article_02_1.html.
- 5.** SCHOLZ, Dieter; SERESINHE, Ravinka, STAACK I, LAWSON C. Fuel Consumption due to Shaft Power Off-Takes from the Engine. In: *4th International Workshop on Aircraft System Technologies*. Hamburg; 2013. <http://Off-Takes.ProfScholz.de>
- 6.** Exxon. *Jet Engine Oil Consumption (Understanding Why Rates Vary)*.; 2016. <https://www.exxonmobil.com/en/aviation/knowledge-library/resources/jet-engine-oil-consumption>.
- 7.** EASA. *Research Project: AVOIL. Characterisation of the Toxicity of Aviation Turbine Engine Oils after Pyrolysis. Final Report EASA_REP_RESEA_2015_2*. Cologne: European Aviation Safety Agency; 2017. <https://www.easa.europa.eu/document-library/research-projects/easarepresea20152>
- 8.** Exxon. *Jet Engine Oil System, Part 2 (Bearing Sump Lubrication)*.; 2017. <https://www.exxonmobil.com/en/aviation/knowledge-library/resources/jet-engine-oil-system-2>.
- 9.** Michaelis S. Implementation Of The Requirements For The Provision Of Clean Air In Crew And Passenger Compartments Using The Aircraft Bleed Air System. 2016. <http://www.susanmichaelis.com/caq.html>.
- 10.** Aviation Week. CFM56 Engine's Performance, Extended Time-on-Wing Advantage. [journalhealthpollution.org](https://aviationweek.com/optimizing-engines-through-lifecycle/did-you-know-cfm56-engines-performance-extended-</div><div data-bbox=)

Installation and Data Acquisition from a Real Time Air Quality Sensor (RTAQS) Monitoring Pilot Breathing Air

Grant M. Slusher, Jennifer A. Martin, Brian A. Geier, Kathy L. Fullerton, Claude C. Grigsby, Darrin K. Ott

Air Force Research Laboratory, 711th Human Performance Wing, RHXBC, UES Inc, Dayton, USA

Corresponding author:

Grant Slusher

slusher.grant.m@gmail.com

jennifer.martin.39@us.af.mil

KEYWORDS

gaseous sensors, air quality sensors, sensor suite, pilot air quality

ABBREVIATIONS

GC/MS	Gas chromatography–mass spectrometry
TD	Thermal desorption
OBOGS	Onboard oxygen generation system

ABSTRACT

This study revolved around the flight testing of a sensor suite built to address the need for detection elements to protect United States Air Force pilots. A set of gaseous sensors specific to O₂, CO₂, CO, NO_x species, and hydrocarbons both laboratory and flight testing. Additionally, thermal desorption (TD) tube was collected for contaminant discovery through gas chromatography mass spectrometry analysis. Thirty-two sorties were flown. Of the sensors O₂, CO, and CO₂ returned measurable values. Overall, both the sensor readings and the TD tube sampling were successful in monitoring the breathing air supplied to the pilot.

INTRODUCTION

An increase in fighter jet pilot physiologic incidences over the past ten years has warranted the request for a system to monitor the breathing air produced onboard. Air crew approaching mass media outlets with reports of physiological events has highlighted

the need to address the current deficiencies in sensing capabilities. From a forensic standpoint no system exists to eliminate potential causative factors of these events. To respond to this increased frequency of incidence the United States Air Force (USAF) assembled a team of specialists to identify a potential cause(s). The team consisted of 711th HPW/USAFSAM military, civilians, and contractors focusing on collecting samples of breathing air along with sensing from the breathing line in real time. The 711th collaborative group worked to assess the effectiveness of already existing technology. Ultimately a collaboration between the 711th, NASA Glenn Research Center (GRC), and Makel Engineering materialized to leverage developing gas sensor technologies. The direct interface between 711th and Makel engineering lead to a prototype known as the Real Time Air Quality Sensor (RTAQS) that included sensors specific to O₂, CO₂, CO, NO_x species, and hydrocarbons paired with a TD tube sampling system. This prototype was tested in the exposure chamber, and its performance evaluated against “real world” pressure and contaminant events. Eventual collaboration with the Test Pilot School of Edwards Air Force Base created a rare opportunity to install the device on a two-seat training F-16.

METHODS

The RTAQS was installed in an altitude chamber where the concentration of O₂ was increased to 50% and run through a profile of stepped altitudes up to 20,000 ft equivalent pressure. For the remainder of the sensors MultiRAE standard gasses were fed through to confirm positive response and functionality.

Edwards’ engineers with the Test Pilot School converted a map case to an envelope to install the RTAQS unit. In addition, they designed a specialized lid that would allow flight line personnel to access the communications port for data download, and the top mounted TD tube for replacement on a per flight basis. While TD tubes were replaced for each flight, larger data downloads from the sensors’ logger occurred at two-week intervals. Those data were then provided to the 711th HPW along with the coordinated flight integrity data for overlay.

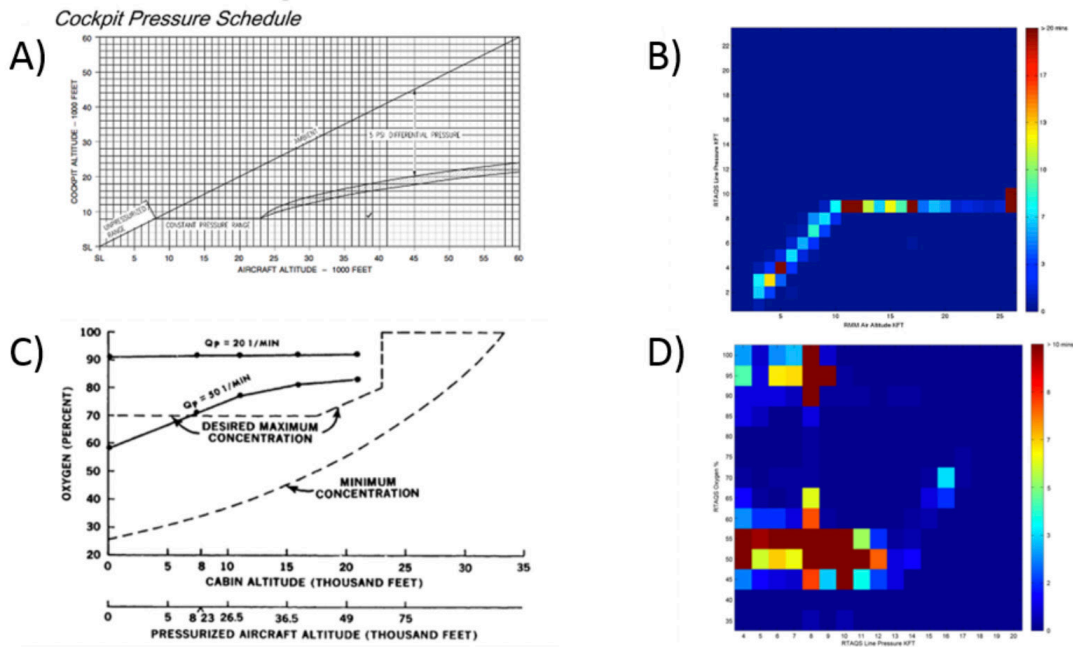

Figure 1 — Programmed versus observed pressures and O₂ concentrations. The figures above compare the expected pressures (A) versus the observed line pressures (B). Also, based on the expected O₂ concentration (C) we can determine how well the observed adheres to the set profile (D).

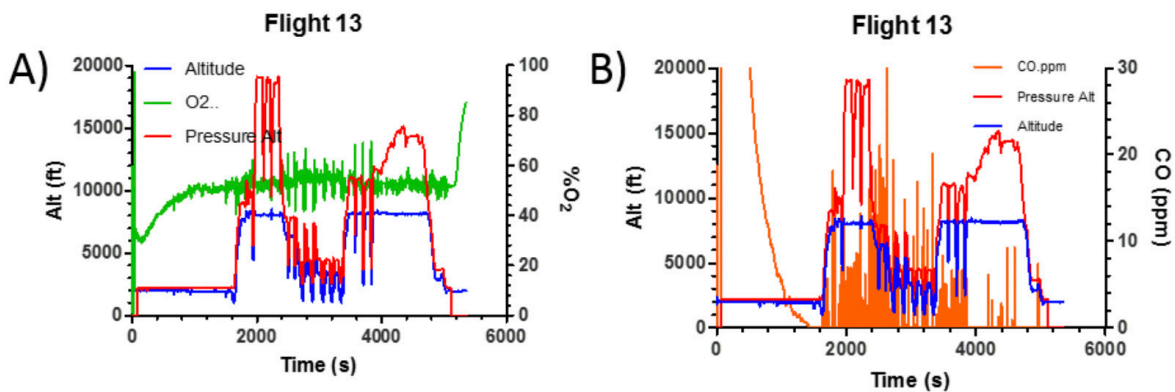

Figure 2 — Flight profiles compared against O₂ and CO concentration. Relationships between spikes in both O₂ (A-green) and CO (B-orange) appear synchronous with rapid ascents and descents as recorded throughout the flight.

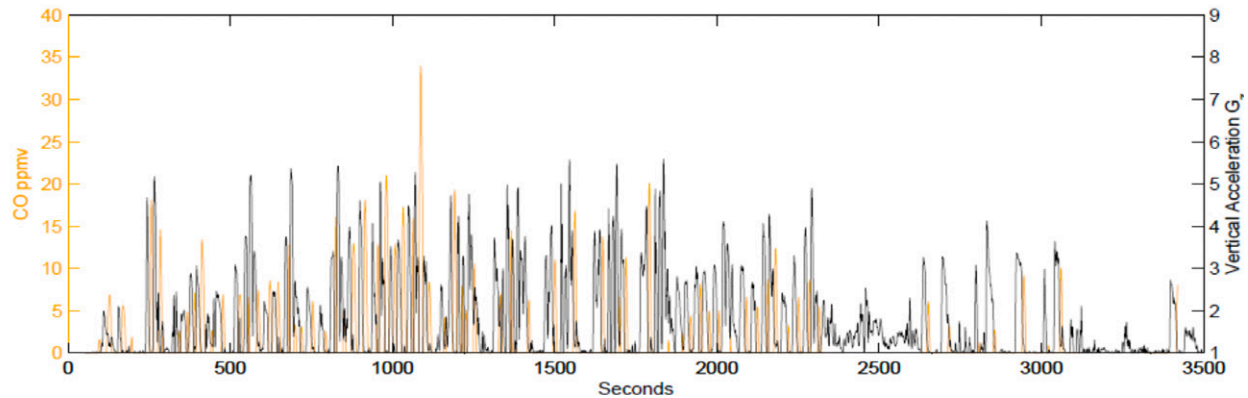

Figure 3 — Carbon monoxide plotted against the absolute vertical acceleration. During analysis it was found that G load (black) and O₂ variation were predictive correlates of the appearance of CO spikes (orange).

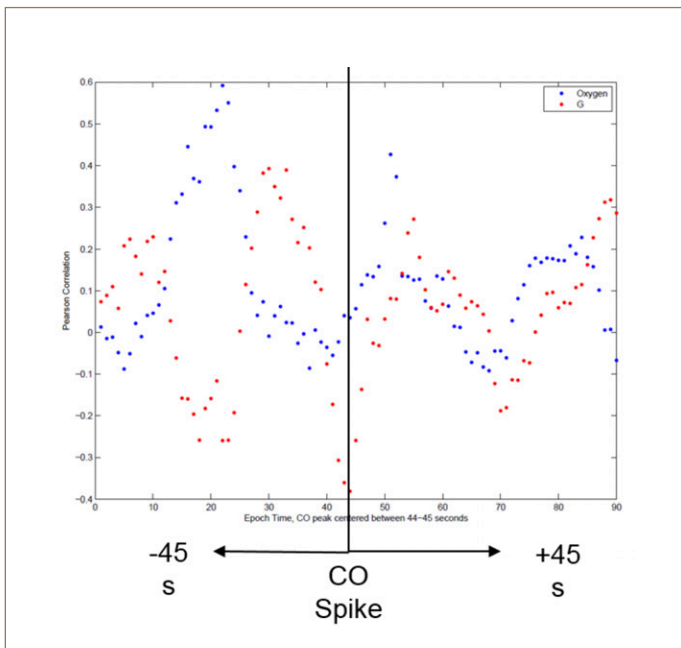

Figure 4 — Correlative model suggesting it's possible to predict occurrence of a CO spike based on O₂ and G-load.

TD tubes returned to the 711th were loaded onto a TD auto sampler and analyzed using gas chromatography–mass spectrometry (GC/MS). The EPA method TO-17 was used to identify a set of 65 specified compounds. While concentrations were derived for each, they were not valid as the sample volume acquired to each tube exceeded the calibrated volume of the GC/MS system.

All data were then analyzed by an in-house statistician looking for relationships between the sensor readings of the RTAQS and the data taken from the jet's in-flight characteristics.

RESULTS

Thirty-two (32) sorties were completed with the unit installed on the aircraft. Of those 32-sensor data was successfully acquired from a total of 20. Due to operator failure to power up the system sensor data was not collected from the remaining 12. Of the 20 successful, ten had accompanying flight integrity data downloaded directly from the jets' onboard computer. Thermal desorption tubes were successfully collected in 16 of the sorties where sensor data was acquired.

Aggregate graphs of both the pressure in the breathing line, and the O₂ concentration supplied to the pilot

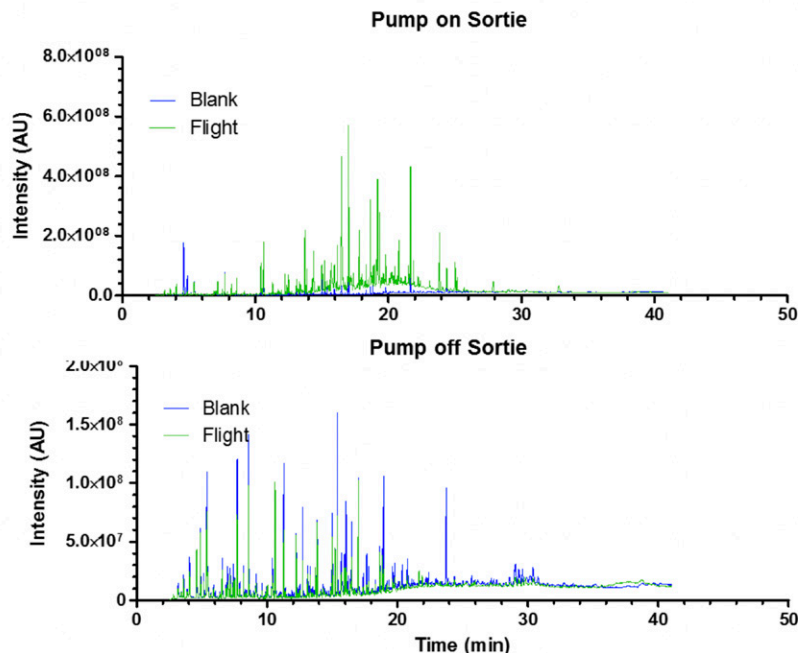

Figure 5 — Chromatographic data from TD-Tubes collected during the test sortie. For each sortie a passive “background” sample (blue) accompanied the flight tube (green) to control for non-flight exposures. In certain cases, the unit was not powered up and thus did not collect to the TD tube. There is an observable difference between the blank and flight tube for the “Pump on Sortie”, but negligible intensity difference for the “Pump off Sortie”.

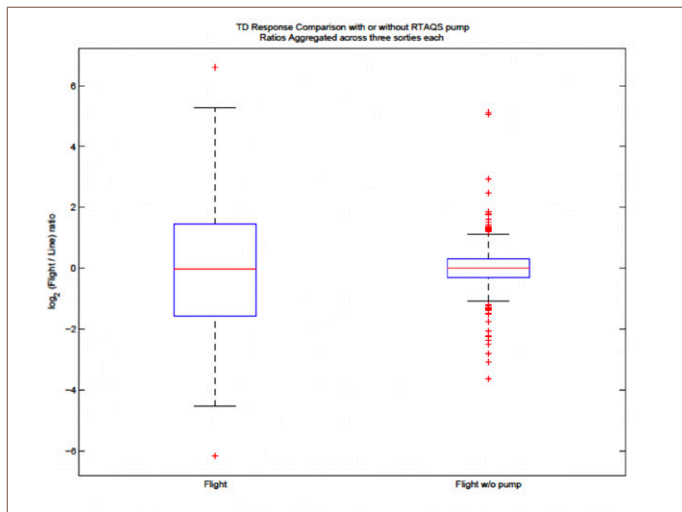

Figure 6 — Difference between flight tubes and blank tubes with regards to enrichment of compounds collected to TD-Tube. It should be noted that TD tubes associated with flights where the unit was not powered on by flight crews are similar to their “background” counterpart in the fold change of the total ion chromatogram.

showed relative agreement between the published programmed values,¹ and the observed values (Figure 1). In a small portion of sorties the O₂ levels reached the 90th percentile (possibly dictated by the “maximum mode” of the OBOGS). Breathing line pressure also traced the flight profile (Figure 2). Minor oscillations occurred in the O₂ readings that synchronized with changes in the absolute altitude of the jet. Carbon monoxide readings were also correlative with changes in G-load and vertical acceleration (Figure 3 and Figure 4). After GC/MS analysis direct comparisons were made between the flight TD tube and its accompanying “background” tube to confirm anything was collected (Figure 5 and Figure 6).

CONCLUSIONS

This was the first flight testing of a combination sensor suite and sampling media. While these data are interesting with regards to the O₂, CO, and sampled

contaminants it is difficult to draw direct conclusions with regards to the OBOGS performance. It should be noted that the F-16 flown for the duration of this study was a non-incident aircraft, and that no physiological events took place throughout the study. Only one CO spike exceeded the set TWA (50 ppm) values with 50.2 ppm. This spike lasted a matter of seconds while the TWA values are derived from constant exposure for an eight-hour work day.

Instead, these data can be treated as a training set for future test sorties. By increasing the N for test sorties the focus would be placed on three major points discussed above. First, pressure and O₂ would continue to be directly compared to the programmed expected values of the airframe. This would differ depending on the jet type, but would still be regulated based on the engineered specifications. Second, the same correlations between CO and the jet's flight profile would be tested to answer the following questions: 1) is there a repeatable spike in CO with increasing G-load or ascent/descent, and 2) are the same variables correlative in different aircraft or must a separate model be built? Finally, we've identified a list of compounds from the TD tubes collected to base future sensor development on. These compounds are all EPA method TO-17 compounds and quantifiable under the right sampling regime. We were unable to quantify for this test due to the lack of control over the sampling time, but for future reference, steps have been taken to reduce the flow rate over the tube and provide a functional sampling volume.

References

1. Horch T, Miller R, Bomar J, et al. *The F-16 Onboard Oxygen Generating System: Performance Evaluation and Man Rating.*; 1997.

A Win-Win-Win Path for Flight Safety, Health, and Corporate Profits

Colin L. Soskolne^{1,2}

1 University of Alberta, Edmonton, Canada

2 Health Research Institute, University of Canberra, Canberra, Australia

Corresponding author:

Colin L. Soskolne

colin.soskolne@ualberta.ca

KEYWORDS

flight safety, occupational health, epidemiology, public health, bias, cabin air quality

ABBREVIATIONS

INEP International Network for Epidemiology in Policy

ABSTRACT

When evidence of harm mounts and denial dominates thus suppressing truth, health scientists must work to defend those harmed and prevent future harms. Their advocating for truth would result in improved safety and health for crew and passengers, and crises would be minimized. Other implicated parties include those dominating policy usually with a financial interest; responsible action from them would result in enhanced reputation with commensurate business advantages; it also would result in reduced economic burdens from compensatory damages. Those with responsibility for aircraft maintenance and insurance also would be spared cost overruns. Human rights and justice must prevail.

Context of this keynote address

Epidemiology is the science of population health and well-being. Epidemiologists study the distribution and determinants of disease in populations and apply the knowledge gained to the control of health problems. The focus is on preventing harms to populations (i.e., morbidity; premature mortality; and well-being). Epidemiology is, in fact, the applied science that informs rational health policy by bridging toxicology (results from animal experiments) to the human response to toxicants.

Epidemiological analysis and interpretation of data can result in controversy. Reports based on poor science, or misleading reports from special interest groups, can foment uncertainty, confuse the public and policy-makers, and lead to delayed or damaging policies that negatively impact people and the living systems on which they depend.

The *International Network for Epidemiology in Policy* (INEP), formerly known as the *International Joint Policy Committee of the Societies of Epidemiology* (IJPC-SE) works at the interface of research and policy. We strive to bring clarity to the science of epidemiology, paving the way to rational evidence-based policy. We work to promote and protect public health by serving as an ethical and effective counterweight to the misuse of epidemiology.

INEP is a not-for-profit consortium of 24 (at time of going to print) national and international volunteer, professional epidemiology organizations, spanning six continents, that have joined together to ensure health for all through ethical, independent and transparent science. It works collaboratively and transparently to address health-related issues and minimize harm. It hosts forums and develops position statements and policy briefs with recommendations to protect and improve public health. Through its collective efforts, INEP brings the benefit of a unified professional voice in the public interest.

Ultimately, rational policy will be influenced by evidence. The generation of evidence by trained scientists is expected to follow scientific and ethical principles such that valid science results. INEP (formerly IJPC-SE) was one of the endorsers of the 2017 Aircraft Cabin Air Quality Conference.

History of scientific misconduct and dishonesty

Misconduct and dishonesty in science have been known since the times of, among others, Galileo and Newton in the basic and physical sciences. The conventional wisdom of science being a strictly logical process, with objectivity the essence of scientists' attitudes, errors being speedily corrected by rigorous peer scrutiny and

replication, is an idealized construct. And, since the advent of applied health sciences, like epidemiology, the opportunities for misconduct and dishonesty have grown. Today, the driver of these likely is more the financial incentives rather than in former days when job security and glory may have been more what motivated such conduct.

The work of epidemiology involves navigating through all types of bias that influence research in public health. Because it is possible to manipulate experimental and control groups in ways that introduce bias and thus fail to serve the public interest through the pursuit of truth (as expected of scientists), it is ever more recognized that ethical training and oversight are crucial.

Our ethics and values determine in large part our behaviors and the choices that we make as scientists, being that scientists are also human and subject to human frailties. The four fundamental principles of bioethics, one being no more important than the other, are:

- *Respect for autonomy* – requires respect for individual rights and freedoms
- *Beneficence* – requires doing good
- *Non-maleficence* – requires doing no harm
- *Social and distributive justice* – requires the fair and equitable allocation of risks and benefits to all without discrimination

All biomedical studies must consider, in advance of any study, the impact of the study being proposed from the vantage point of these four principles. In public health research, additional principles apply and also must be considered, including the need to:

- *Protect the most vulnerable*
- *Engage with the community*
- *Apply the Precautionary Principle*, and
- *Conduct oneself with integrity*

In all of this, given the many competing interests involved in population and community health research, we must

not be naïve about the forces at play that influence both science and policy.

Great vigilance and personal integrity are required to counter the influence of financially interested parties and corrupt/morally bankrupt governments where a sizeable proportion of elected representatives are beholden to powerful moneyed interests. In particular, the seduction by moneyed interests in using academics to downplay or deny the seriousness of the hazards must be recognized. These are the studies that will infiltrate the scientific literature to cast doubt and foment uncertainty. Libraries of books and movies, including documentaries and docudramas, are accessible that have explored and exposed these misdeeds.

Biases that can be introduced into applied research, either wittingly or unwittingly, and that are counter to the public interest are:

- *Publication Bias* – selective material infiltrates the peer-reviewed literature
- *Suppression Bias* – questions/findings that upset powerful interests are suppressed
- *Repression Bias* – questions/findings that we know might upset powerful interests we refrain from asking/presenting
- *Funding Bias* – only that which powerful interests want studied will be studied

These and other biases, if allowed to go unchallenged, present the policy maker with a conundrum. By increasing uncertainty, the policy-maker's ability to implement health policy is made all the more difficult. The tobacco example is perhaps the best known in that it took some 50 years, and with many sick people and premature deaths along the way, before policy could be introduced to more effectively control people's access and exposure to tobacco. It has been demonstrated through freedom of information just how the industry mounted disinformation campaigns, lied, manipulated, and deceived both the public and policy makers, and how they co-opted or appropriated scientists to lie. The real tragedy is that, while business does what business

sees itself as needing to do to increase profits, scientists accept their money and then proceed to please their sponsor. We must remain vigilant as to whether this is what is happening in the area of cabin air quality.

How manipulation operates

When a scientist discovers a finding that does not support the *status quo* and goes contrary to the interests of a powerful stakeholder, the “Four D’s” are applied, in that what they are reporting will not result in action, but rather will be confronted with:

- *Deny* – denial that the findings could be correct;
- *Delay* – in that more research will be called for;
- *Divide* – in that commissioned work will result in biased findings; and
- *Discredit* – if the scientist persists, he/she will be discredited.

This paradigm (i.e., the “Four D’s”) was applied many times over in the case of each of the following substances before policy was ultimately changed:

- Tobacco
- Nickel
- Benzene
- Lead
- Asbestos
- Climate Change

The question now is: When will cabin air quality be rationally addressed, given that it has and continues to be subjected to the “FOUR D’s”?

For those who wittingly, and for large sums of money, prostitute themselves by casting aside their scientific values (i.e., the pursuit of truth in the public interest), a toolkit of techniques is available to them to skew results and contribute to the production of junk science:

- Under-powered studies
- Inadequate follow-up methods
- Inadequate follow-up time
- Inappropriate biomarkers of exposure
- Contaminated controls

- Unbalanced discussion
- Selective disclosure of competing interests
- Biased/selective interpretation
- Mechanistic information is ignored for inferring effects
- Exaggerated differences are made between human and toxicology studies, the insistence being on separating effects seen in animals from effects in humans
- The fact that molecular structures predicting hazard potential is ignored
- The insistence on first demonstrating effects in local populations of exposed people despite demonstrated effects in humans elsewhere
- The failure to make explicit the implicit value judgements that go into deciding appropriate standards of evidence for drawing policy-relevant conclusions (i.e., suppressing dominant interests and values)

Conformist thinking

To understand the role of influence and its impact, we must recognize that we all operate within the framework of:

- A dominant paradigm
- A contextual narrative

With this recognized, what role can impartial science play in the public interest?

Working at the nexus of research and policy, there are many forces, or drivers, at play in working to inform policy in order to maintain and improve population health. Ideology is one class of such drivers; financial conflicting interests is another. Both are integral to our personal contextual narratives (i.e., the dominant paradigm that defines the story of our lives: that which gives meaning to us as individuals in society, reducing our objectivity).

Leadership requires the ability to think beyond the constraints of the dominant paradigm. Yet, the pressures are relentless from vested interests that maneuver

their way onto review panels, influence boards of our professional associations, and infiltrate the published literature with junk science.

Expert witness tensions arise between the plaintiff and defense sides of the argument in tort actions where the rubber hits the road concerning policy decisions. Regarding engine and aircraft fluids — consisting of tricresyl phosphate (TCP), other hazardous substances, including by-products of pyrolysis — along with cases of fume events reported to date, and illness reports proximate to these events with observed long-term sequelae, the Precautionary Principle would seem warranted: “Where there is a risk from a certain agent, the presence of uncertainty shall not be used as a reason for postponing cost-effective measures to prevent such exposure.”

THE “FOUR D’s” classically applied to cabin air quality

Not only is the European Aviation Safety Agency (EASA) in DENIAL, they are DELAYING action by sponsoring further research. They deny any health effects from fume events, despite the reality of sick people resulting from such events with acute illness proximate to exposure events, and with longer-term effects seen in some cases; they dismiss “aerotoxic syndrome” as even possible. Their linear reductionist approach, invoking the argument of low-level OPC in cabins, appears to provide them the basis for ruling out any human health effects from fume events, and also from low-level exposure to cabin air, even in the absence of fume events.

Their bias toward finding no-effect is apparent in their project description using words such a “misguided” in ruling out alternative hypotheses in their study. One is left wondering if, with their approach, they will measure the most relevant exposures and endpoints.

Recent wisdom shared from Morris Greenberg tells us that, under the Precautionary Principle, “... *the discharge of gases and fumes into an aircraft cabin can be justified only after prior investigation finds the practice to be innocuous. The chemical cocktails to which passengers and crew are exposed will vary qualitatively and*

quantitatively, so that, even if a standard examination methodology has been employed, their effects need not be identical between incidents.”

From a human safety and health perspective, the obligation of the industry is to avoid supply air contaminating cabin air. With the design of one aircraft more recently, the problem has been largely avoided. Given what is already known, while more research may be of interest to advance knowledge to achieve greater precision in our estimates of effect, we have sufficient experience to act now to protect cabin crew, pilots, and passengers by engineering the problem out and acknowledge previous harms caused.

Of note, the German Airline Association’s Trade Group (BDL), among others, was invited to participate in this seminal conference. Their own Position Statement claims “*Regarding the topic of cabin air, it has repeatedly been stated in the past few years whether the health of the passengers and crews as well as the safety of the flight could be endangered by the penetration of burned oil residues into the cabin air. It is therefore important to the airlines to know whether there are actually reliable findings from scientific investigations that confirm these statements and whether there is a problem that necessitates changes in flight operations or the maintenance or manufacture of aircraft.”*

If BDL had seen a glaring inconsistency between its decision to not participate in this conference and with the above words, they may have aligned their actions with their words by sending a representative and some of the German aviation industry to participate in the conference. Instead, by boycotting or shunning an opportunity to have a seat at the table, the opportunity to advance science is denied. Science advances through transparent, open discussion, and access to data.

CONCLUSIONS

- Systemic, institutionalized bias constrains science to conform to the dominant paradigm;
- Susan Michaelis and team are to be saluted for their

leadership in moving us all beyond the confines of the dominant paradigm;

- We all lose when the trajectory on which we find ourselves is flawed and unsustainable;
- A WIN – WIN – WIN outcome is most likely when the pursuit of truth is sought with a mind open to adapting to empirical realities; and
- The GCAQE is leading to a favorable outcome in which flight safety, health, and corporate profits all win.

We must persistently hold corporate leaders' feet to the fire on their obligation to protect worker and passenger safety and health based on valid evidence, decency, common sense; only then will rational policy prevail.

Acknowledgements

My participation was made possible thanks to the generosity of:

- Global Cabin Air Quality Executive (GCAQE)
- Air Canada Pilots Association

Disclosure

In the interests of transparency:

- I have served as an expert witness in litigation (not related to this topic) on behalf of plaintiffs in the past, monies from which generally went into a University-managed research account.
- As a professional legacy, between 2012 and 2016, I bankrolled the INEP (formerly known as IJPC-SE) to become a self-sustaining public interest charity serving as a veritable David vs. Goliath in the pursuit of truth against moneyed influence in health policy.
- My comments are my own and are not necessarily endorsed by INEP.

Moving Towards Total Cabin Filtration: Filtering the Fresh Air Supply

David Stein, Stephen Simpson, Paul Roux

Pall Corporation, New Port Richey, USA

Corresponding author:

David Stein

david_stein@pall.com

KEYWORDS

clean air technology, filtration, fume events

ABBREVIATIONS

CAT	Clean air technology
HEPA	High efficiency particulate air
VOCs	Volatile organic compounds
A-CAF	Advanced cabin air filters

ABSTRACT

On occasion, engine related contamination is able to enter the aircraft cabin as part of the fresh air supply, this can result in reduced air quality and expensive delays and schedule disruptions. Pall Aerospace are developing a filtration system, Clean Air Technology (CAT) that will remove this contamination from the fresh air supply before it is able to reach the cabin or cockpit.

Pall has been serving the aerospace industry for over 70 years with innovative, enabling products. Pall was the first company to develop and introduce hospital-grade (H14) High Efficiency Particulate Air (HEPA) filters in the aircraft cabin air recirculation line and Pall Aerospace now proudly leads the way in the development and introduction of advanced cabin air filters designed to remove additional contaminants present in the cabin such as odors and volatile organic compounds (VOCs).

Airlines are constantly looking at ways to improve their operation. Statistics show that about a third of delays are due to events not associated with weather or air traffic control (ATC). These delays include fume events, where

noxious odors are detected in the cockpit or passenger cabin.

The frequency of reported air quality incidents has increased over the years and this increase is due not to age-related deteriorating aircraft performance but more to an increased awareness of cabin air quality among flight crew and passengers and also improved crew training related to reporting procedures for fume events.¹ For example, one airline experienced a 5-fold increase in the number of reported incidents after completion of crew training; however, this number was subsided once mitigation procedures were introduced.

While VOCs are generated from many sources, including sources inside the cabin, the VOCs from engine fluids, primarily lube oils, create the most concerns in the industry. These VOCs can stem from oil leaking past seals into the hot engine bleed air. The vaporization, partial oxidation, or combustion of that oil creates VOCs, some of which are or can become toxic.^{2,3} Since engine bleed air is used for the fresh air supply, these VOCs can then enter the cabin and cockpit. Fume events are disruptive because identifying an errant smell is time consuming and crew members are not always able to detect the source.

Despite the relative rarity of fume events, they occur frequently enough that the cost of disruption (~ \$50,000) is of concern to many airlines.⁴ For example, FAST, the Airbus technical magazine, pointed out in 2013 that “a noticeable cabin odor can be generated from ingesting only a very small amount of oil.” Bad smells worry passengers, and crews may delay take-off until these dissipate. The longer the odor lingers, the longer the delay. In the worst cases, a flight will be cancelled or, if already airborne, diverted, which can cost an airline a significant amount of money. The British government estimated a fume event occurs roughly once in every 2,000 flights, which equates to 50 fume events per day worldwide. A 2002 report by the U.S. National Research Council quoted 1.29 air quality events per 1,000 flights for the Airbus A320 and in a report by Dr Shahadi it was estimated over five bleed air related events occur every

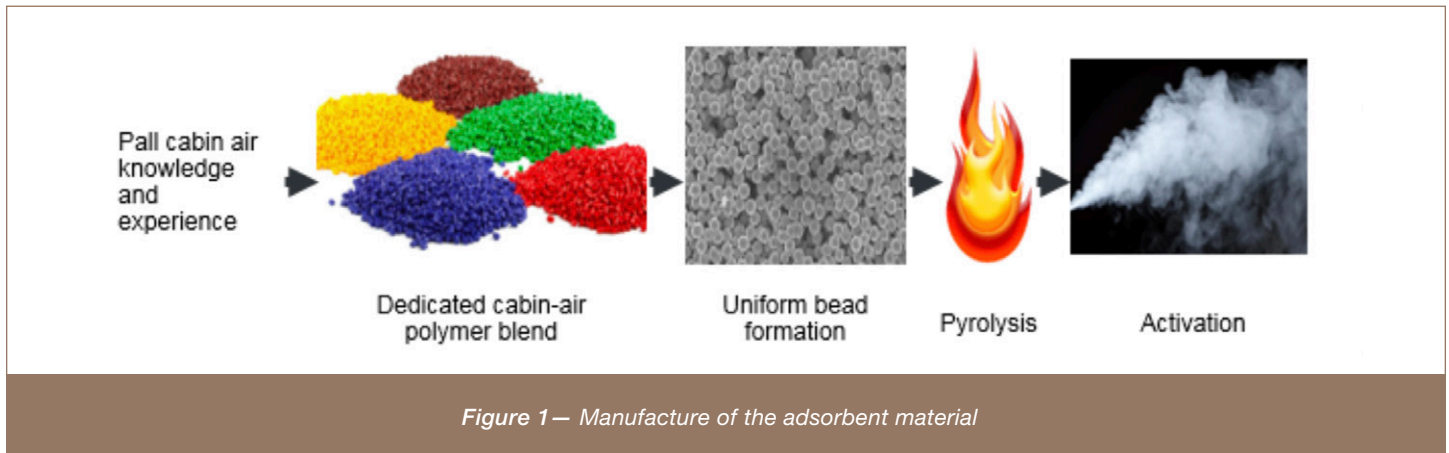

day in the US.⁵

A-CAFs

A number of airlines have taken steps and introduced new procedures to improve cabin air quality. These new steps include the installation of advanced cabin air filters (A-CAF). These filters minimize schedule disruption by shortening the dissipation period of an odor. Laboratory tests and test on an aircraft of a US airline have shown that odors dissipate three times faster in a cabin protected by A-CAF compared to cabins that do not have A-CAF installed.

Pall’s A-CAF products are specifically designed for aerospace applications. Pall partnered with a specialty chemical manufacturer to develop a synthetic carbon adsorbent material that targets the contaminants of concern in aircraft bleed air while maintaining performance over a long life to meet the existing changeout interval of the original HEPA filters and airline maintenance schedules. The synthetic carbon also has a low sensitivity to humidity and is presented in the filter such that it has an extremely low pressure drop, both of which enhance to its high life.

Figure 1 shows the high-level process of how the adsorbent material is manufactured. A select blend of polymers is chosen based on the adsorption performance requirements of the target VOCs. These

polymers are formed into spherical beads using a proprietary process, and the beads are then pyrolyzed and activated using high temperature steam. These beads are then formed into a low pressure drop and stable matrix.

These synthetic carbon adsorbent materials outperform many conventional materials such as natural-substrate activated carbon due to higher surface area per unit mass as well as the tailored surface chemistry created by the choice of starting material and the activation process. Pore size and pore size distribution is important as these are direct measures of the amount of surface area available for VOC adsorption (larger pores mean less surface area which means less VOC capacity) while surface chemistry controls the “stickiness” of the pore wall for different ranges of VOCs.

Most VOC molecules are extremely small; for example, Toluene is ~0.2 nm therefore a high volume of micro and mesopores provide the optimum adsorbent performance. The accepted method of assessing pore size and volume is using BET analysis. Pall’s bespoke synthetic carbon adsorbent has more micropore and macropore surface area as compared to standard, coconut shell activated carbon and over 22% more internal surface area (~1339 m²/g vs ~1,092 m²/g). Table 1 shows the calculate BET values.

Figure 3 shows SEM images of standard coconut

Sample ID	Surface area (m ² /g)	Micro pore area (m ² /g)	Meso pore area (m ² /g)	Total pore volume (cc/g)	Micro pore volume (cc/g)	Avg. pore dia. (Å)	Data correlation to model
Synthetic carbon	1339 ± 67	1174	165	0.645	0.441	19.3	99.90%
Coconut shell	1092 ± 57	945	147	0.53	0.359	19.4	99.90%
% Synthetic to coconut shell	23%	24%	12%	22%	23%	N/A	N/A

Table 1 – BET Values

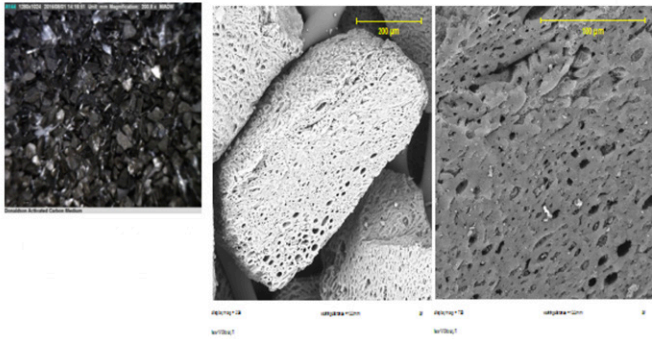

Figure 3 – SEM Images of Standard Coconut Carbon

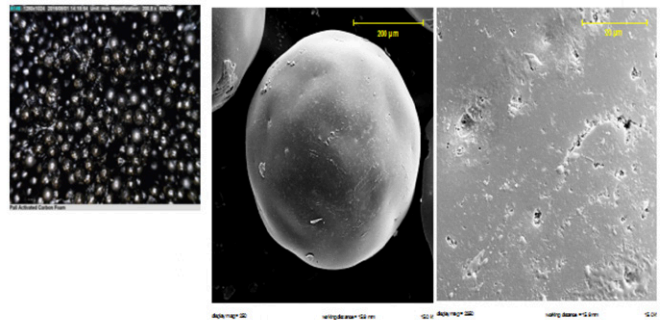

Figure 4 – Pall's Bespoke Synthetic Carbon Adsorbent

carbon and Figure 4 shows Pall's bespoke synthetic carbon adsorbent. Figure 5 shows a transmission electron microscope (TEM) image of the two materials. The difference in pore size distribution and the "wasted space" of the natural carbon is immediately evident in the images.

Pall tested full sized filters made from both natural activated carbon and our bespoke adsorbent using test parameters equivalent to those found in commercial, single aisle aircraft. Figure 6 shows the relative performance of the two filters over a period of an hour. This test shows the divergence in efficiency between the two materials. The bespoke adsorbent is still over 90% efficient after exposure while the natural carbon is less

than 60% efficient.

Advanced cabin air filters are more expensive than traditional HEPA cabin air filters, therefore it is important that they demonstrably achieve their performance goals.

The A-CAF filters must fit in the same form factor as the original recirculation filters, which necessitates a small reduction in the capacity of the HEPA filter. As an important requirement for the airlines is to maintain a similar changeout interval, significant on-wing testing has to be performed to ensure that the addition of the VOC adsorbent material did not impact product life. The only true means of establishing the changeout interval

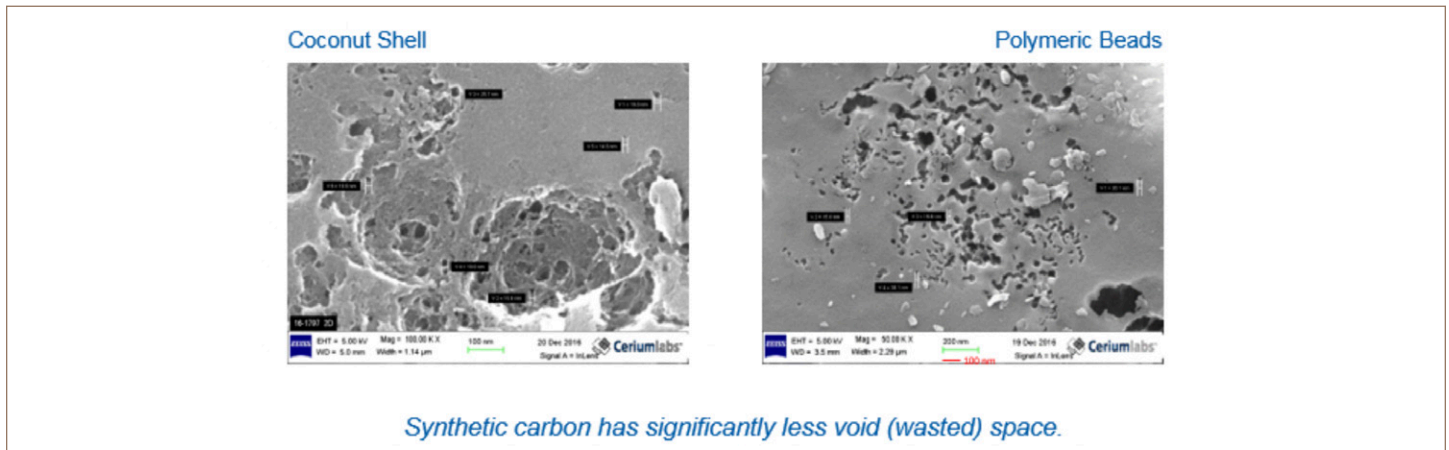

Figure 5 — A TEM image of the two materials

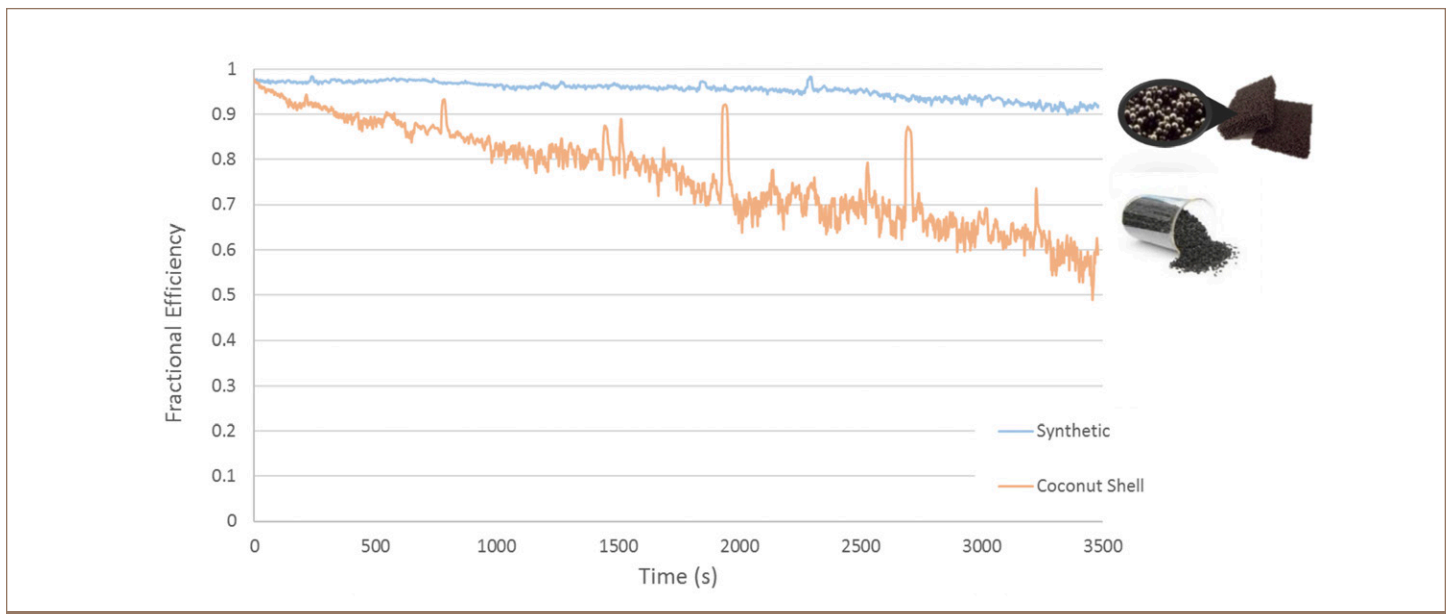

Figure 6 — Relative performance of the two filters

is to determine the performance of a number of filters over thousands of hours in service. Figure 7 shows the results of these types of tests for an A330 A-CAF. All of the data points shown represent tests on filters used on commercial aircraft. The blue line shows the data that was generated from the original trials in the late 1990's which were used by Airbus to set the changeout interval. Results from trials on the latest standard of filters are

shown in the red band and it can easily be seen that the life of the HEPA layer of today's A-CAF filters, due to improved manufacturing processes as well as the elimination of smoking, will easily meet the HEPA-only MPD interval of 5,000 hours.

The other factor in determining the life of the filter is the carbon efficiency. Figure 8 shows tests on filters used

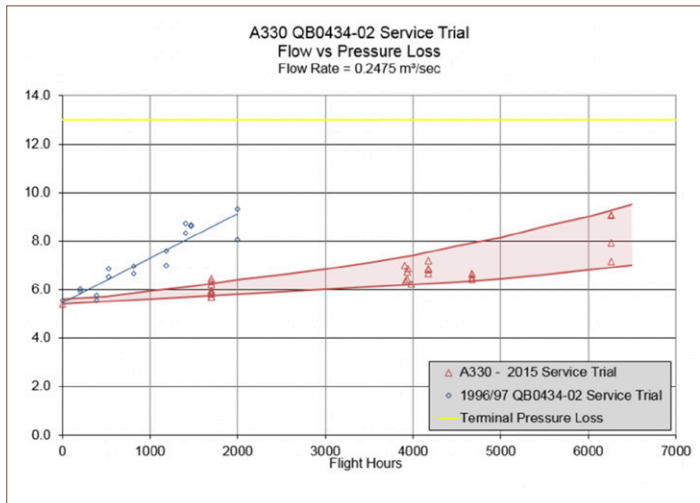

Figure 7 – Results of these type of tests for an A330 A-CAF

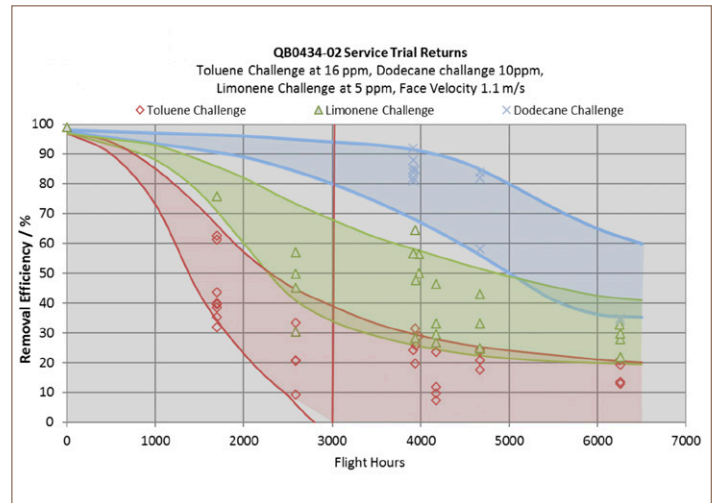

Figure 8 – Tests on filters used on commercial aircraft

European Short Haul: 660 Flight Hours - Reported Fume Event

Total 69049 µg/g

Methoc Compound	Quantity µg/g	% of Total	Comments
1 CS2 Est Cyclopentasiloxane, decamethyl-	33209	48.10	Cosmetics, hair spray, skin care products
2 CS2 Est Limonene	4145.8	6.00	Cosmetics, fragrances, cleaning agents
3 CS2 Est Cyclohexanol, 5-methyl-2-(1-methylethyl)-, (1.alpha.,2.beta.,5.alpha.)-(.-)-	2569.5	3.72	Topical medicines, perfumes
4 CS2 Est Cyclohexasiloxane, dodecamethyl-	1761.1	2.55	Personal care products, solvent
5 CS2 Est Dodecane	1751.9	2.54	Jet fuel related
6 CS2 Est Isopropyl myristate	1719.9	2.49	Solvent for perfumes, skin care products
7 CS2 Est Undecane	1465.6	2.12	Aircraft fluid related
8 CS2 Est Tridecane	1355	1.96	Jet fuel related
9 CS2 Est Cyclotetrasiloxane, octamethyl-	1122.7	1.63	Cosmetics, personal care products, cleaning agents
10 CS2 Est Homosalate	1115.5	1.62	Common component of sunscreen
11 CS2 Est Decane	1029.7	1.49	Jet fuel related
12 CS2 Ex Tributyl phosphate	990.9	1.44	Component of aircraft hydraulic fluid
13 CS2 Est 2,2,4-Trimethyl-1,3-pentanedil diisobutrate	837.6	1.21	Plasticiser, adhesives and sealants
14 CS2 Est Pentadecane	827.1	1.20	Jet fuel related
15 CS2 Est 2-Ethylhexyl salicylate	775.4	1.12	Cosmetics and sunscreens
16 CS2 Est o-Xylene	734.4	1.06	
17 280 TD Toluene	676.5	0.98	
99 280 TD 6-Methylthio[2,3-b]pyridine	1.8	0.00	
100 280 TD Benzophenone	1.3	0.00	
280 TD Phosphoric acid, tris(2-methylphenyl) ester	1.3	0.00	Tri-Cresyl Phosphate
102 280 TD 7-Hexadecene, [Z]-	1.2	0.00	
103 120 TD Isopropyl Alcohol	1.2	0.00	
104 120 TD 4-Methyldocosane	1	0.00	
105 120 TD Ethanone, 1,1-(2,6-dimethyl-3,5-pyridinediyl)bis-	1	0.00	
106 280 TD Phthalic acid, isopropyl propyl ester	1	0.00	
107 280 TD 1-Pentadecene	0.7	0.00	
108 280 TD 9,10-Anthracenedione, 1,4-dimethyl	0.7	0.00	
109 120 TD 1-(2-Hydroxyethoxy)-2-(vinylthio)ethane	0.6	0.00	
110 120 TD 1-(2-Hydroxyethylthio)-2-(2-vinylthioethoxy)ethane	0.5	0.00	
111 280 TD o-Terphenyl	0.5	0.00	
112 280 TD 2H-Benzimidazol-2-one, 1,3-dihydro-5-methyl-(Dimethyl)[4-(2-phenyl-1,9b-dihydro-5-oxa-3,3a-diazacyclopenta[aj]naphthalen-4-yl)phenyl]-amine	0.1	0.00	
113 280 TD 1,2-Benzenedicarboxylic acid, mono(1-methylethyl) ester	0.1	0.00	

Table 2 – Analysis of the Filters

on commercial aircraft. The blue line is again the original trial data and this shows that the carbon efficiency when challenged with toluene is reduced to zero at around 2500 hours and this was the data used by Airbus in setting the original changeout interval. The red band shows most recent performance of the A330 A-CAF when challenged with Toluene against service hours and the green band shows the performance of the same filters when challenged with Limonene. In both cases the performance of the filters is much better than the original trial and this is due to optimization of the adsorbent and also to the elimination of smoking which reduces the adsorbent life.

Limonene was chosen as a test agent as it has a boiling point of 176°C which is more representative of the engine-based VOC's that are found in the cabin than toluene which boils at 110°C.

The VOC that have been deemed the most harmful boil even higher at over 250°C and although not shown on the chart the efficiency of the carbon against these VOC's is an order higher again, these higher boiling point VOC also do not desorb at the temperatures they filter operates at in the cabin.

The VOC removal efficiency of any adsorbent degrades over life. The estimated time to clear a fume event increases from ~2.5 minutes with a fresh filter to (~ one cabin air exchange interval) to ~5.5 minutes after 6,000 flight hours (~2 cabin air changes).

Part of the service Pall provide to the airlines is an analysis of the filters to determine what contaminants have been removed and retained on the filter from the cabin and cockpit. A sample of this data is shown in Table 2. Key to note are a) TBP, a product of hydraulic fluid, is always present on every filter tested and b) TCP has been identified on filters from aircraft that have experienced a fume event.

PUREcabin

It is important to note that installation of A-CAF will not stop the source of the problem and prevent odors and VOC's in the bleed air entering the cabin.

However, there are developments underway that will prevent engine related odors from reaching the cabin and cockpit and Pall is pleased to provide this short status update on our efforts.

A-CAF improves filtration of the recirculated air. While this creates a significant improvement in the cabin air quality, it does not address the source of the contaminated air in the cabin.

Fume events, engine related odors, and engine generated VOCs can be stopped from entering the cabin and cockpit if the fresh air supply is filtered. Pall is developing a total cabin filtration system (fresh and recirculated). Such a system will dramatically improve cabin air quality and eliminate the problems and issues associated with VOCs in the cabin air. Pall expects to have our first such product available for the A320 by the end of 2018.

Pall is also developing a sensor technology that can identify the presence of VOCs in the bleed and cabin air and identify their source. The sensor will be able to categorize and odor and identify its source. We also anticipate that it may be possible to predict the onset of a mechanical issue and enable preventative maintenance to take place.

References

1. BFU. *BFU 803.1-14. Study Of Reported Occurrences In Conjunction With Cabin Air Quality In Transport Aircraft*. Braunschweig: Bundesstelle für Flugunfalluntersuchung; 2014.
2. Eastman Aviation Solutions. Skydrol SDS. <https://www.eastman.com/Brands/EAS/Skydrol/Pages/Home.aspx>.
3. ExxonMobil. Material Safety Data Sheets. <https://www.msds.exxonmobil.com/IntApps/psims/psims.aspx>.
4. Ausick P. The High Cost of Cancelled Airline Flights. <https://247wallst.com/services/2014/10/29/the-high-cost-of-cancelled-airline-flights/>. Published 2014.
5. Shehadi M, Jones B, Hosni M. Characterization Of The Frequency And Nature Of Bleed Air Contamination Events In Commercial Aircraft. *Indoor Air*. 2015;26:478-488. doi:<http://dx.doi.org/10.1111/ina.12211>

GCAQE Closing Speech

Keith Taylor

Green MEP for South East England, London, UK

Corresponding author:

Keith Taylor

keith.taylor@europarl.europa.eu

KEYWORDS

contaminated air, bleed air, exposure, standards, systems

ABSTRACT

Keith Taylor, Green MEP for the South East, delivered the closing speech at the International Aircraft Cabin Air Conference on Wednesday 20 September 2017. The conference, at Imperial College London, was hosted by The Global Cabin Air Quality Executive (GCAQE) in association with Pall Aerospace, Unite the Union, the British Professional Pilots union (PPU), and the University of Stirling. The two-day event brought together industry experts, cabin crew unions, and researchers to discuss the health concerns surrounding passenger and crew air supply contamination feared to be responsible for several deaths of pilots and crew and hundreds of incidents where pilots have fallen ill, sometimes at the controls. Frequent flyers and young children could also be affected. Earlier that week, EasyJet announced its plans to fit filters, manufactured by Pall Aerospace, to its cabin air systems in a move seen as an acknowledgment of the health concerns surrounding 'aerotoxic syndrome' – which has been long been denied by airlines. Keith Taylor is a member of both the European Parliament's Environment and Public Health and Transport and Tourism Committees.

Closing speech

Good afternoon Ladies and Gentlemen, I'm Keith Taylor, the Green MEP for South East England and it is a pleasure to be here. I'd like to thank the organizers at GCAQE for inviting me to speak with you all at the end of this important conference.

It has been very eye-opening for me to learn about some of the issues you've been discussing here over the past two days and I hope that the outcome of getting you all together is that it will be a useful springboard for action

to continue to tackle some of the biggest challenges ahead on improving cabin air quality.

Some of you have first-hand experience of the impact contaminated air can have and you can truly appreciate the urgency with which this issue needs to be addressed.

But I also understand there are some stakeholders vital to moving forward on this issue still absent from the discussion and this is perhaps one of the greatest obstacles to making flights safer for the crew and passengers alike.

Using bleed air from the engine in the cabin and cockpit enables passengers to breathe on board an aircraft, and this is an approach that has been used by the aviation industry for decades. But since the outset, information has been available to the industry - as uncovered by the US military in the 1950s - that there are adverse effects associated with exposure to heated engine oils.

Despite the risks, the civil aviation industry opted for this ventilation system and in the past 30 years especially, it has become increasingly evident that this was a dangerous choice.

This is because there is no filtration process in place between the bleed air from the engine and the cabin, and indeed because the engine seals leak, low levels of contamination have been witnessed on many flights and more large scale 'fume events' or toxic leakages have also been reported, as explained by some of the speakers at this conference.

The issue of exposure is very complicated - there can be both short-term and long-term impacts and the symptoms are wide ranging - from blurred vision and dizziness, to nausea, vomiting, respiratory difficulties, irritation to skin, eyes - the list goes on. As with many health risks, the impacts are greater for those more vulnerable - the very young, the very old.

And it is particularly worrying that the risks stretch to those who aren't born yet. Pregnant women on board flights jeopardize the health of their fetus, but there is

simply a lack of awareness that this issue even exists - let alone how dangerous it really is. This is unacceptable and action must be taken to draw more attention to these risks as a matter of urgency.

From what I have learnt of the issue, it appears that there are five key areas that warrant immediate further attention. I've called them the five S's.

Science

The first is science - A lot of independent, peer-reviewed research has been undertaken in recent years which demonstrates that this is a genuine issue. But industry has been a step removed from this process, choosing to fund its own studies and often not asking the right questions. This detracts from the urgency of the situation and slows down progress to address the issue.

There is a need to do more research, we need to be asking the right questions, with methodologies suitable to provide sufficient answers and this process needs to be transparent. But as well as exploring what is in the air, we need a better understanding of what happens after exposure events - both chronic repeat exposure and leak events and we need to know more about the effects of a mixture of toxins. Above all, industry must engage with the findings.

Standards

Then we have standards - The standards that are in place are not up to the job. Whilst the containers of the substances used in the fuel contain health warnings, these warnings do not translate into passenger and crew safety information and this is a major oversight.

The current standards also do not address the complexity of the impact that a mixture of toxins may have when combined. They have not been tested under high altitude conditions. In some cases, benchmarks or exposure limits do not even exist - in short, they are entirely unfit for purpose.

Systems

The next issue is concerned with the systems in place

on the aircraft to both detect and warn against potential exposure. The regulations are clear, where there is a likely threat, detection and warning systems should be fitted to enable an informed response to the risk.

No airline has such equipment in place to address the potential exposure to heated engine oil fumes. This presents both occupational and public health liabilities and there is a moral and legal obligation here to address this shortcoming.

Solutions

But there are solutions - there are relatively simple technological fixes which would remove the problem entirely from the industry - the filtration system presented here at the conference represents a relatively low-cost measure that could be retrofitted onto the aircraft in use today. It would be a travesty for the industry to not take this solution seriously.

And as seen by the introduction of the Dreamliner, it is entirely possible to have a separate compressor for the cabin air, without needing to rely on bleed air at all. New craft should have this system fitted as standard.

Sharing

Finally, we need more sharing - This is a little-known issue, but that needs to change. Passengers and crew alike should be aware of the dangers that face them when boarding a flight. Whether we are talking about a leak event, or the low-level exposure that they are at risk of on any given craft to any given destination, people need to know. There is a need for a larger scale public awareness effort on this issue. Similarly, there needs to be more pressure put on decision-makers to act.

You have all taken the time to come and share your scientific knowledge, your expert opinions and your personal experiences, but where are EASA, where is the European Commission, where is the FAA, the airline CEOs and those responsible for ultimately ensuring the welfare of airline employees and the travelling public? They aren't here.

And it is this - more than anything - that stands in the way of making progress on all five of these areas. Industry and policymakers need to engage with this issue, be more open to change, be more transparent about the current situation and what needs to be done to rectify it.

As Professor Soskolne pointed out, we've seen with tobacco, asbestos, and countless other industries, change will come, but it will be a fight and it will take time. This issue has been unaddressed for far too long and the time to change is now.

The European Union enshrined the precautionary principle into law in 2012 and it is an approach which should certainly be used in this context. Even if we don't have all the answers and there are gaps in the science, if there is even a chance that the current system is leading to health impacts, especially long-term health impacts, then reasonable steps should be taken to mitigate against these risks. It is unacceptable for the industry to take any other stance on this.

CONCLUSIONS

As a member of the Transport and Tourism Committee in the European Parliament, I've been an active advocate of the need to urgently improve air quality across our towns and cities. And increasingly governments are starting to take the health threats posed by ambient air pollutants seriously. But it has been a hard battle and it is far from over.

Here, cleaning up the aviation industry does not only have to do with the urgent need to address the emissions created by the plane in the outside air, but the air being breathed inside too.

Thinking long term about the sustainability and health related challenges of the industry, both issues need to be taken much more seriously and I am committed to working with my fellow MEPs in Brussels to raise the profile of the issue and to lobby my peers to take action on this dangerous health threat as a priority.

Organophosphate-Based Chemicals, Axonal Transport, and Cognitive Dysfunction

Alvin V. Terry Jr.

Augusta University, Augusta, USA

Corresponding author:

Alvin V. Terry Jr.

aterry@augusta.edu

KEYWORDS

organophosphates, aerotoxic syndrome, acute toxicity,

ABBREVIATIONS

OP Organophosphates

ABSTRACT

Organophosphates (OPs) are toxic chemicals that are almost ubiquitous in our environment and they pose a significant health risk to millions of people worldwide. While the acute toxicity of OPs has been studied extensively, the effects of repeated exposures to levels of OPs not associated with acute toxicity, especially on cognitive function are poorly understood. Using animal models and *in vitro* methods we have established that repeated (subacute) exposures to some OPs can lead to protracted deficits in several domains of cognition, and that impairment in axonal transport may represent a potential underlying mechanism of these adverse effects.

INTRODUCTION

Organophosphates (OPs) are found in hundreds of useful products including pesticides, defoliants, fire retardants, industrial solvents, lubricants, plasticizers, and fuel additives.¹ Unfortunately, many OPs are highly toxic and deleterious health effects of OPs in humans have been documented.^{2,3} In the case of acute poisoning, the mechanism of both the acute symptoms of OP toxicity and the long-term neurological consequences of acute toxicity is well established. Specifically, inhibition of acetylcholinesterase (AChE) by the OP leads to marked

elevations in synaptic acetylcholine levels which in turn lead to excessive stimulation of both muscarinic and nicotinic acetylcholine receptors.^{4,5} Depending on the exposure level, some of the acute effects of OPs including excessive secretions, cardiorespiratory depression, and seizures can be life threatening. These acute effects of OP exposure can also lead to a variety of long-term neurological and psychiatric consequences in survivors. In contrast to acute OP poisoning, the long-term consequences of repeated exposures to levels of OPs below the threshold for acute “cholinergic” toxicity are less clear and controversial. This type of exposure is relatively common in agricultural workers and pesticide sprayers and it has been associated with persistent alterations in psychomotor speed, executive function, visuospatial ability, working and visual memory.⁶ Lower level, repeated exposures to OPs have also been associated with a variety with adverse symptoms in other contexts. For example, low-level exposures to OP-based insecticides (e.g., chlorpyrifos, dichlorvos) as well as nerve agent-OPs (sarin and cyclosarin) following the destruction of an Iraqi munitions storage complex at Khamisiyah, Iraq, in March 1991 have been implicated in the etiology of Gulf War illness (GWI), which affects up to one-fourth of the veterans from the first gulf war. GWI is characterized by a complex set of symptoms including unexplained fatigue, respiratory difficulties, musculoskeletal pain, gastrointestinal distress, skin rashes, headaches, and a variety of neurological and neuropsychiatric problems including cognitive impairment.⁷ In addition, repeated exposures to the OP, tri-cresyl phosphate (TCP), used as an anti-wear additive to jet engine oil, has been implicated in “aerotoxic syndrome” a term used to describe acute and persistent symptoms reported by aircrew following exposures to fumes in aircraft cabins. Symptoms include ear/nose/throat irritation, skin conditions, nausea and vomiting, respiratory problems, headaches, weakness and fatigue, nerve pain, tremors, and cognitive.^{8,9}

Need for prospective studies

It is important to note that there are a number of confounding factors that can limit the interpretations of the human studies described above, particularly when

attempts are made to make causal connections between illness symptoms and specific underlying biological mechanisms. Most of the human literature on OP exposures is based on retrospective investigations, case reports, and epidemiology and in each of the conditions, the study subjects were likely exposed to multiple substances as well as additional environmental insults or conditions (e.g., heat, stress, smoke, high altitude). Other factors that could confound the interpretations of the aforementioned studies include the inability to establish clear dose-effect relationships and the length of the periods of exposure to particular OPs. Therefore, a critical need exists for prospective studies (that can only be conducted ethically in non-human model systems) to determine what neurobiological consequences can indeed be linked directly to repeated exposures to particular OPs and when adverse effects can be linked, to establish dose-effect and exposure-time relationships and well as the underlying biological mechanisms of the adverse effects.

Summary of studies conducted in our laboratory

Based on the information provided above, one major goal of our laboratory is to prospectively investigate (in model systems) the effects of repeated exposures to OPs at doses/concentrations not associated with acute toxicity. Our behavioral results in rodents to date indicate that this type of exposure can result in a variety of cognition-related deficits that have been reported in humans including impairments in spatial learning and memory, sustained attention, and cognitive flexibility.¹⁰⁻¹⁵ We have also investigated potential mechanisms of the cognitive symptoms described above and have observed OP-related alterations in neurotrophin receptors and cholinergic proteins in brain regions that are important to cognitive function (e.g., cortex, hippocampus).^{11,13} Moreover, we have observed OP-related decreases in axonal transport in several studies, observations that may explain the alterations neurotrophin receptors, cholinergic proteins, and cognitive impairments. For example, we have observed decreases in the transport of vesicles in sciatic nerves ex vivo,¹¹ impairments in the movement of mitochondria and membrane bound organelles (MBOs) in axons in primary neuronal

culture,¹⁶⁻¹⁸ and deficits in the transport of a manganese (Mn^{2+})-based contrast agent in the optic nerve pathway of living rats using a magnetic resonance imaging (MRI) method.¹⁹ Given the fundamental importance of axonal transport to neuronal health and function, these observations led us to hypothesize that OP-related deficits in axonal transport may contribute to many of the long-term neurological and psychiatric effects that have been attributed to OPs.

CONCLUSIONS

The results of our prospective animal experiments to date with the insecticide OP, chlorpyrifos (CPF) and the nerve agent, diisopropylfluorophosphate (DFP), have established that repeated exposures to OPs to levels that are below the threshold for acute toxicity can lead to protracted deficits in spatial learning, memory, and sustained attention. Moreover, our experiments suggest that impairments in axonal transport may represent a potential underlying mechanism of these adverse effects of OPs. In future studies, our laboratory will further investigate the mechanism of the OP-related impairments in axonal transport to identify therapeutic targets so that more effective treatment strategies can be developed for OP-related illnesses.

References

1. Soltaninejad K, Shadnia S. History of the Use and Epidemiology of Organophosphorus Poisoning. In: Balali-Mood M, Abdollahi M, eds. *Basic and Clinical Toxicology of Organophosphorus Compounds*. London: Springer; 2014.
2. Worek F, Thiermann H, Wille T. Oximes in organophosphate poisoning: 60 years of hope and despair. *Chem Biol Interact*. 2016;259(Pt B):93-98. doi:10.1016/j.cbi.2016.04.032
3. Masson P, Nachon F. Cholinesterase reactivators and bioscavengers for pre- and post-exposure treatments of organophosphorus poisoning. *J Neurochem*. 2017;142 Suppl 2:26-40. doi:10.1111/jnc.14026
4. Ecobichon DJ. Pesticide use in developing countries. *Toxicology*. 2001;160(1-3):27-33.
5. Pereira EFR, Aracava Y, DeTolla LJJ, et al. Animal models that best reproduce the clinical manifestations of human intoxication

with organophosphorus compounds. *J Pharmacol Exp Ther.* 2014;350(2):313-321. doi:10.1124/jpet.114.214932

6. Mackenzie Ross SJ, Harrison V, Madeley L, et al. Cognitive function following reported exposure to contaminated air on commercial aircraft: methodological considerations for future researchers. *J Biol Phys Chem.* 2011. doi:10.4024/30MA11A.jbpc.11.04

7. Research Advisory Committee on Gulf War Veterans' Illnesses. *Gulf War Illness and the Health of Gulf War Veterans: Research Update and Recommendations, 2009-2013.* Washington DC; 2014.

8. Harrison V, Mackenzie Ross S. An emerging concern: Toxic fumes in airplane cabins. *Cortex.* 2016;74:297-302. doi:10.1016/j.cortex.2015.11.014

9. Howard, C V, Michaelis S, Watterson A. The Aetiology of " Aerotoxic Syndrome " - A Toxicological Pathological Viewpoint. *Open Acc J Toxicol.* 2017;1(5):1-3. doi:10.19080/OAJT.2017.01.555575

10. Middlemore-Risher ML, Buccafusco JJ, Terry AVJ. Repeated exposures to low-level chlorpyrifos results in impairments in sustained attention and increased impulsivity in rats. *Neurotoxicol Teratol.* 2010;32(4):415-424. doi:10.1016/j.ntt.2010.03.008

11. Terry AVJ, Gearhart DA, Beck WDJ, et al. Chronic, intermittent exposure to chlorpyrifos in rats: protracted effects on axonal transport, neurotrophin receptors, cholinergic markers, and information processing. *J Pharmacol Exp Ther.* 2007;322(3):1117-1128. doi:10.1124/jpet.107.125625

12. Terry AVJ, Stone JD, Buccafusco JJ, Sickles DW, Sood A, Prendergast MA. Repeated exposures to subthreshold doses of chlorpyrifos in rats: hippocampal damage, impaired axonal transport, and deficits in spatial learning. *J Pharmacol Exp Ther.* 2003;305(1):375-384. doi:10.1124/jpet.102.041897

13. Terry AVJ, Buccafusco JJ, Gearhart DA, et al. Repeated, intermittent exposures to diisopropylfluorophosphate in rats: protracted effects on cholinergic markers, nerve growth factor-related proteins, and cognitive function. *Neuroscience.* 2011;176:237-253. doi:10.1016/j.neuroscience.2010.12.031

14. Terry AJ. Functional Consequences of Repeated Organophosphate Exposure: Potential Non-Cholinergic Mechanisms. *Pharmacol Ther NIH Public Access.* 2012;134(3):355-365. doi:10.1038/jid.2014.371

15. Terry AVJ, Callahan PM, Beck WD, et al. Repeated exposures to diisopropylfluorophosphate result in impairments of sustained attention and persistent alterations of inhibitory response control in rats. *Neurotoxicol Teratol.* 2014;44:18-29. doi:10.1016/j.ntt.2014.04.069

16. Middlemore-Risher M-L, Adam B-L, Lambert NA, Terry AVJ. Effects of chlorpyrifos and chlorpyrifos-oxon on the dynamics and movement of mitochondria in rat cortical neurons. *J Pharmacol Exp Ther.* 2011;339(2):341-349. doi:10.1124/jpet.111.184762

17. Gao J, Naughton SX, Beck WD, et al. Chlorpyrifos and chlorpyrifos oxon impair the transport of membrane bound organelles in rat cortical axons. *Neurotoxicology.* 2017;62:111-123. doi:10.1016/j.neuro.2017.06.003

18. Gao J, Naughton SX, Wulff H, et al. Diisopropylfluorophosphate

Impairs the Transport of Membrane-Bound Organelles in Rat Cortical Axons. *J Pharmacol Exp Ther.* 2016;356(3):645-655. doi:10.1124/jpet.115.230839

19. Hernandez CM, Beck WD, Naughton SX, et al. Repeated exposure to chlorpyrifos leads to prolonged impairments of axonal transport in the living rodent brain. *Neurotoxicology.* 2015;47:17-26. doi:10.1016/j.neuro.2015.01.002

ICAO Circular 344 Guidelines on Education, Training and Reporting of Fume Events

Antti Tuori

IFALPA, Montreal, Canada

Corresponding author:

Antti Tuori

antti.tuori@fimnet.fi

KEYWORDS

fume events, crew member exposure, awareness raising, circular

ABBREVIATIONS

AMTs Aircraft maintenance technicians

ABSTRACT

The ICAO published Circular 344 “Guidelines on education, training and reporting practices related to fume events” at the end of 2015. The scope of the guidance is limited to education, training and reporting of fume events by flight crew, cabin crew, and aircraft maintenance technicians (AMTs). In addition, the management should also receive the basic training. The idea is to enable crews and AMTs to prevent, recognize and respond to the presence of fumes/odour. The circular does not address occupational health issues. The overall content of the circular was presented at the conference.

At the 38th session of the International Civil Aviation Organization (ICAO) General Assembly, the International Transport Workers’ Federation (ITF) and the International Federation of Air Line Pilots’ Associations (IFALPA) invited the Technical Commission to consider the flight safety implications of crew member exposure to oil fumes/odor sourced to the aircraft air supply system. ITF and IFALPA also requested the ICAO Council to develop guidance material to improve awareness and training of flight crew, cabin crew, and AMT related to the management of fume events.

As a result of this work, an ICAO Circular 344 “Guidelines

on education, training and reporting practices related to fume events” was published at the end of 2015. Notable is, that the scope of the guidance is limited to education, training and reporting of fume events by flight crew, cabin crew, and aircraft maintenance technicians (AMTs). This enables them to prevent, recognize and respond to the presence of fumes/odor. The circular does not address occupational health issues; nor does it address on board exposure to smoke or fire.

The Circular is divided into six different chapters, see below. Introduction and Basic Education is aimed for all stakeholders, including the management (flight crew, cabin crew, AMTs, and management). As each aviation professional group (i.e. flight crew members, cabin crew members, AMTs) has a specific role in recognizing and responding to fumes, particularly to those that are air supply system-sourced, a group-specific training is provided to them. One important chapter is on reporting of fume events, and this includes an example of the reporting form. Finally, there is a chapter for AMTs on trouble shooting, and a short chapter on investigation.

Chapter 1. Introduction

Chapter 2. Basic education

- For all the stakeholders (pilots, cabin crew, maintenance, management)

Chapter 3. Training

- Group specific training, i.e. parts for pilots, cabin crew and AMTs

Chapter 4. Standardized reporting

- An example of reporting fume is presented

Chapter 6. Event Investigation

- Basic description of the issues to be considered in the fume event investigation

The aim of the circular is to enhance flight safety through raising awareness of fume events as well as training on how to cope with such an event.

REACH Substance Evaluation of TCP

Petra van Kesteren,¹ W.P. Jongeneel,² N.G.M. Palmen,² M. Beekman¹

¹ Bureau REACH, National Institute for Public Health and the Environment (RIVM), Bilthoven, the Netherlands.

² Centre for Safety of Substances and Products, National Institute for Public Health and the Environment (RIVM), Bilthoven, the Netherlands.

Corresponding author:

Petra van Kesteren

petra.van.kesteren@rivm.nl

KEYWORDS

REACH, substance evaluation, human health, risk management

ABBREVIATIONS

ECHA	European Chemicals Agency
REACH	Registration, Evaluation, Authorisation and Restriction of Chemicals
TCP	Tris (methylphenyl) phosphate

ABSTRACT

REACH (Registration, Evaluation, Authorization and Restriction of Chemicals) is a European regulation to improve the protection of human health and the environment from the risks that can be posed by chemical substances. The substance evaluation is a specific process under REACH, carried out by Member States, to clarify whether the use of a substance poses a risk to human health or the environment. The Netherlands started a substance evaluation on tris(methylphenyl) phosphate (TCP) in 2014. This evaluation resulted in a formal request for information related to i.e. neurotoxicity and exposure assessment, which shall be provided by the manufacturers of TCP.

INTRODUCTION

Registration, Evaluation, Authorization and Restriction of Chemicals (REACH) is a European regulation adopted to improve the protection of human health and the environment from the risks that can be posed by chemicals.¹ REACH places the burden of proof on

companies. To comply with the regulation, companies must identify and manage the risks linked to the substances they manufacture and market in the EU. They have to demonstrate to the European Chemicals Agency (ECHA) how the substance can be safely used, and they must communicate the risk management measures to the users. Registration is required to substances that are manufactured or imported in quantities of one ton or more per year per registrant.

The substance evaluation is a specific process under the REACH regulation. Its aim is to clarify whether the manufacture or uses of a registered chemical substance poses a risk to human health or the environment. The substance evaluation process is triggered as a result of risk-based concerns that have not been adequately addressed in the registration process. It involves an assessment of the data in all registration dossiers from all registrants specific to the same substance. The aim is to identify whether new information is needed from the registrants to address and evaluate the concern. Substance evaluation is carried out by the member states; ECHA has a coordinating role in the substance evaluation process.

A substance evaluation follows several steps, including the evaluation of the registration dossier(s), drafting a decision, commenting periods for proposing amendments by the registrants, other member states and ECHA, and reaching unanimous agreement by the Member State Committee (MSC). The Decision contains the grounds for the risk-based concern and the justification for the information request. After agreement, the Decision is sent to the Registrant(s) and new information shall be provided before the given deadline. These newly provided data are evaluated by the evaluating Member State within 12 months of receiving the information and conclusions are drawn relating to potential follow-up actions. Possible follow-up includes a request for new information, regulatory risk management actions or no action when the initial concern has been satisfactorily addressed and no further concern remains.

The Netherlands started a substance evaluation on

tris (methylphenyl) phosphate (TCP) in 2014. The initial concerns were a concern on the persistence, bioaccumulation and toxicity (PBT) and wide dispersive use. Additional concerns that were included during the evaluation were related to substance identity and human health, and attention was paid to exposure assessment and derivation of derived no effect levels (DNELs). A draft decision was made and after taking all the steps following procedure the decision was agreed upon by the MSC in 2016.

The ECHA's Decision includes six requests,² summarized here:

1. *In vitro* dermal absorption study using OECD 428.
2. 90-day repeated dose neurotoxicity study in the rat, by inhalation nose only, according to test OECD 424, using a representative composition of the registered substance. Adaptations and additions to the test are described.
3. Justification for the deviation from the ECHA Guidance in the derivation of the DNELs.
4. An exposure assessment for the exposure scenario of pilots and cabin crew to the registered substance during flights, including a calculation of the inhalation and dermal exposure and calculation of the RCR by combining the RCR (inhalation) and RCR (dermal).
5. Provide all available information on the content and anonymized results of questionnaires, medical and clinical investigations and industrial hygiene assessments among TCP exposed workers, and the study of a possible causal relationship between TCP exposure and neurotoxic complaints.
6. Detailed information on worker exposure for all scenarios, to allow an assessment of the adequacy of the risk management measures in place for the registered substance to be made. Specifications were indicated.

The deadline for providing the requested information is 2

August 2018. When the new information is provided, the Netherlands, as evaluating Member State, will evaluate the data and decide whether the new information submitted meets the requests in the decision. Further, if the evaluating Member State Competent Authority (MSCA) considers that further information is still needed to clarify the concern, a new draft decision may be written.

References

1. ECHA. European Chemical Agency. <https://echa.europa.eu/nl/home>.
2. ECHA. Information on chemicals. <https://echa.europa.eu/nl/information-on-chemicals/evaluation/community-rolling-action-plan/corap-table/-/dislist/details/0b0236e180694747>.

Tricresyl Phosphate Measurement Methods Used to Identify Flight Crew and Passenger Exposure

Chris van Netten

University of British Columbia, Vancouver, Canada

Corresponding author:

Chris van Netten

chris.van.netten@ubc.ca

KEYWORDS

monitoring, neurotoxic agents, sampling strategies, wipe samples

ABBREVIATIONS

TCP

Tri-Cresyl Phosphate

ABSTRACT

Measurement TCP isomers in aircraft environments indicates jet engine oil exposure from bleed air. The neurotoxic, and other, effects associated with these agents make it imperative that exposure measurements are done accurately. Wipe samples are an indicator of the presence of, rather than exposure to, agents. Air sampling is an indicator of inhalation exposure but varies between methods. The VN air sampler was ideal to capture rare bleed air events.

Carbon monoxide, formaldehyde, and ultrafine particulates need monitoring. Axonal transport of ultrafine particles by the olfactory nerve was postulated as one possible route of exposure of the CNS to TCP.

INTRODUCTION

The measurement of Tri-Cresyl Phosphate (TCP) isomers in aircraft has been very important in identifying bleed air as a source of TCP contamination. The highly specific isomer profile of jet turbine oils provides a direct link to turbine oils as the source of this air contamination.

Since TCP isomers are known to affect the central and peripheral nervous systems, accurate measurements

need to be made in order to assess the level of exposure and the risk that is associated with that exposure. In addition to TCP exposure, a large number of additional agents, referred to as pyrolysis products, which have been identified and are also associated with bleed air events. Measuring TCP in aircraft therefore serves two major purposes, it indicates exposure to a neurotoxic agent as well as to pyrolysis products from engine oils that are generated along with TCP release during a bleed air event.^{1,2}

Typical TCP isomer patterns from jet turbine oils are shown in Figure 1. When this pattern is found in aircraft it identifies the source of TCP i.e., jet turbine oils.³

Various sampling strategies have been used to identify TCP isomers in aircraft. These include, filters from the environmental control systems within the aircraft, clothing from occupants, coalescer bags, dust samples, hair samples, sedimentation cards, surface wipe samples, and air samples. Of these, wipe samples and air samples will be further explored in this article.

Wipe samples

Surface wipe samples can be a good indicator of what has sedimented from the air onto a surface and hence what individuals breathing the air were exposed to. This means that we need to know that the surface being wiped was free of contaminants prior to flight. This is only possible with the use of sedimentation cards. Wipe samples from surfaces within the aircraft, unless shown not to be exposed to TCP prior to flight, only show potential exposure which can be over an extended period of time depending on housekeeping procedures used in the aircraft. Wipe sample procedures have been standardized, the procedure can be found in the ASTM website.

It can be observed that the surface wiped from the A380 #3 was an order of magnitude lower in contaminants than A380 #4. Having no information as to who, how well, and where, these samples were collected, no further conclusions can be drawn from these samples at this point.

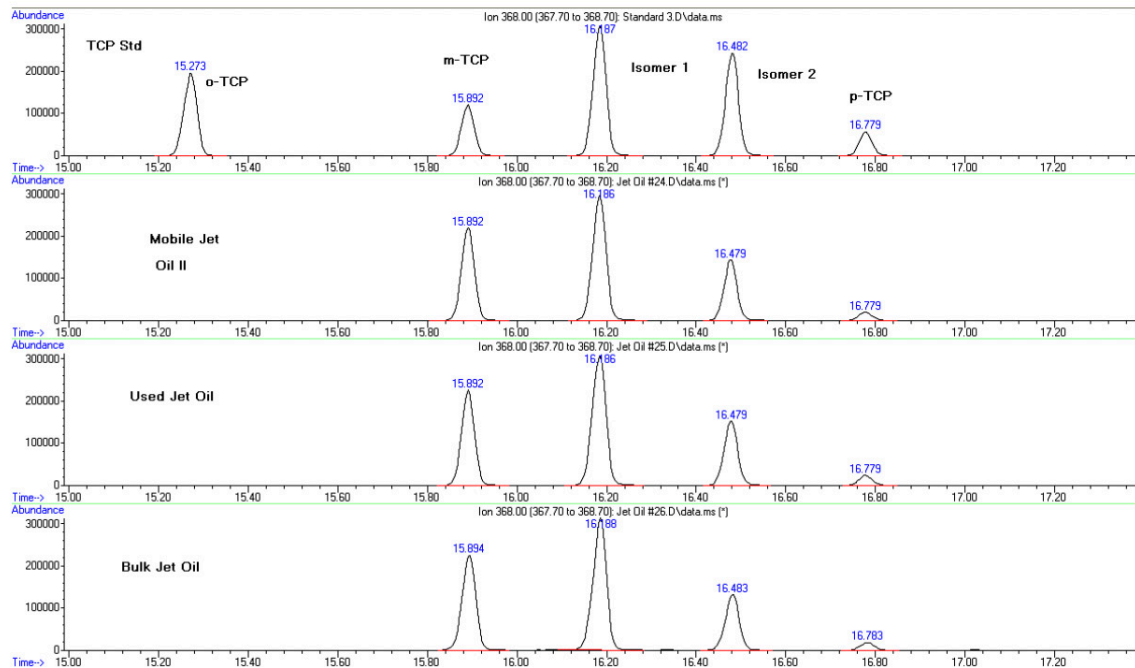

Figure 1 – TCP isomer patterns from jet turbine oils

The specific ion monitoring mode (SIM) for the TCP, i.e. the 368 ion, of these two samples show some interesting results.

It can be observed from the lower trace that all the peaks from the standard are represented indicating that jet turbine oil was the source of contamination. In addition, one can see the presence of a number of additional peaks that have the same molecular weight of TCP. These additional peaks are likely the other TCP isomers that were not found in the turbine oils. If this is indeed the case the presence of these isomers might indeed be evidence of molecular rearrangement of the four original TCP isomers in turbine oil. The physical conditions at the bleed port of the engine are such, i.e. 170 psi and 350°C, that molecular rearrangement is possible. This is further substantiated by the presentation from David Johnson who describes additional conditions present in the micro-environment of the actual bearing lubricated

surface. He concluded from his research that molecular disintegration and rearrangement are likely to occur under these conditions.

Before we can come to those conclusions based on these chromatograms one needs to eliminate a couple of variables, such as the possible presence of these additional isomers in the Eastman 2197 jet turbine oil. An analysis of this oil has not been done yet in our laboratory. Another variable that needs attention is the possibility that the plastic surface, that was wiped, was a source of these additional isomers.

The 12 wipe sample analyses from 12, A380 aircraft indicate that ten were positive for TCP isomers range 3.2-41.4 nanograms per wipe, all 12 wipes samples were positive for tributylphosphate (TBP), a component of hydraulic fluid, range 5.6-108.9 ng/wipe. Seven wipes showed a “hint” of the additional isomers discussed above.

A380 #3

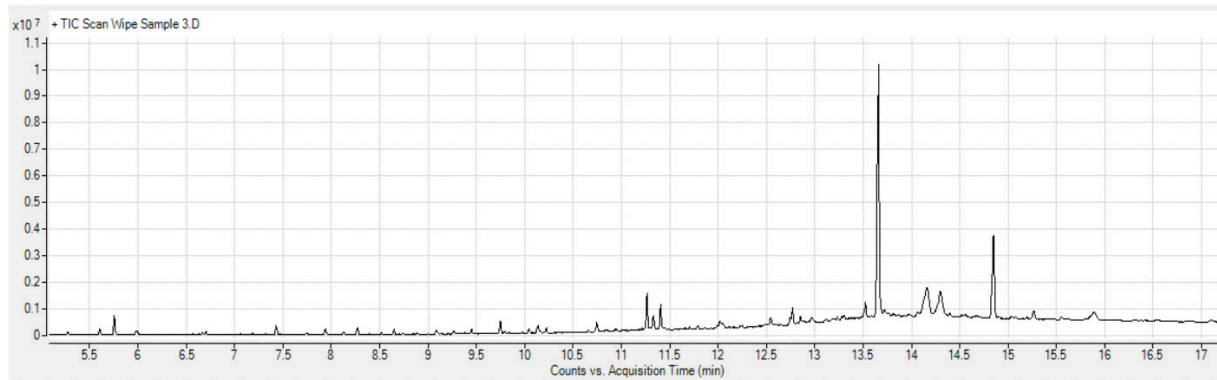

A380 #4

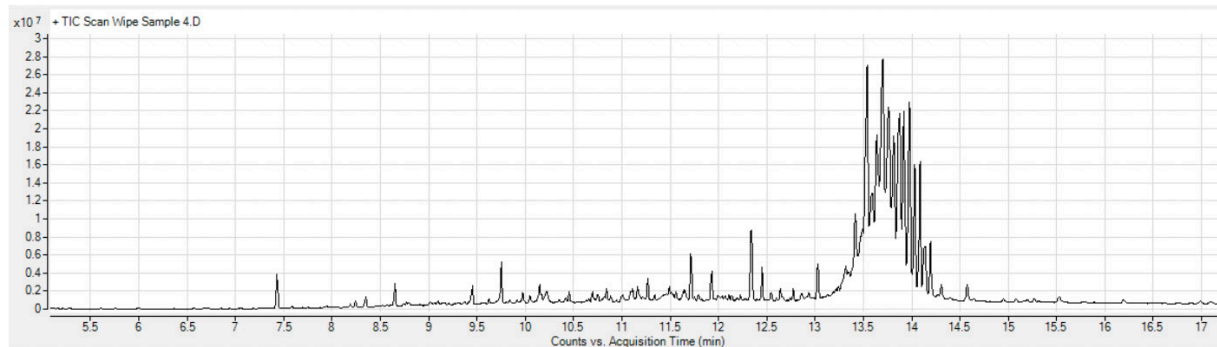

Figure 2 — Analysis of wipe samples. The results from the full scan gas chromatography–mass spectrometry (GCMS) analysis of wipe samples from interior surfaces of two A380 aircraft that were given to our laboratory for analysis.

Direct air sampling

Air sampling for volatile organic compounds (VOCs) are usually done using sorbent tubes filled with a large number of different sorbents such as Tenax, Chromosorb, charcoal, etc.⁴ Non-volatile and semi-volatile compounds are usually collected on a number of substrates, such as quartz (fiberglass) filters. Recently two reports have been published that make reference to the use of sorbent tubes to measure TCP isomers

in the air of aircraft,⁵ and TNO in the Netherlands.⁶ Their descriptions of the methods used to monitor TCP in aircraft air are not specific enough to allow the reader to replicate their procedures leaving it open for speculation. In order to find out what they possibly could have measured, or not measured, we generated a TCP environment in an environmental chamber where we compared Chromosorb 106 tubes ability to capture TCP from the air along with the VN sampler, which uses 37

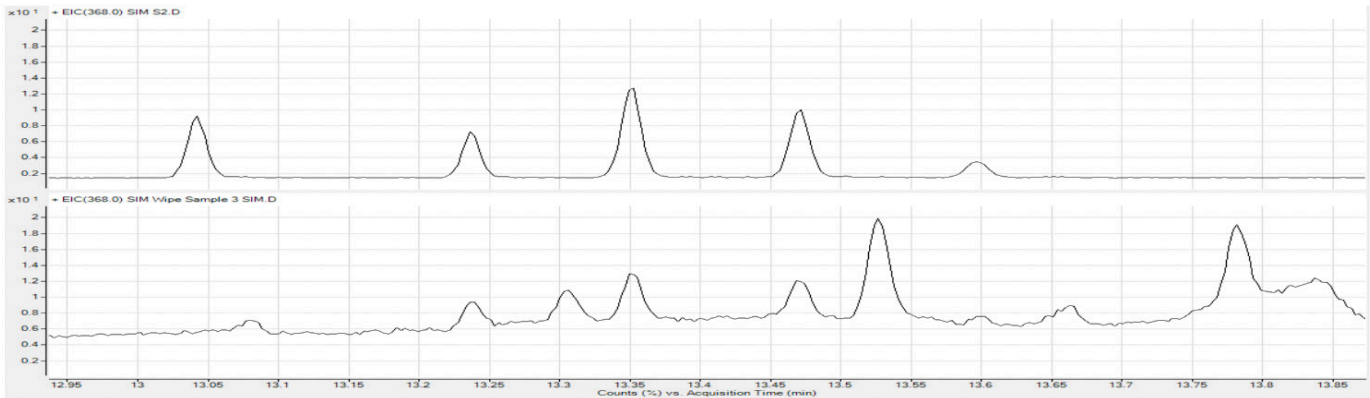

Figure 3 — SIM of Ion 368, of a wipe sample from an A380 aircraft. Top trace is the laboratory standard, lower trace shows the results from the wipe sample

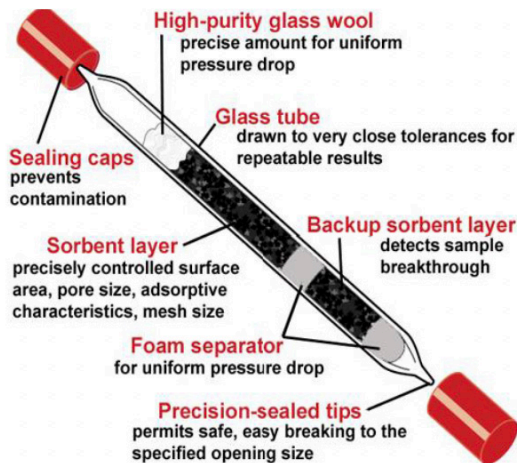

Figure 4 — Example of a sorbent tube



Figure 5 — Environmental setup to compare TCP capturing efficiency

mm Quartz filters (Whatmann).

Typical diagram of a sorbent tube, such as used by some to measure airborne TCP is shown in Figure 4. Environmental setup to compare TCP capturing efficiency is shown in Figure 5.

It was observed that the amount of TCP trapped on the sorbent, Chromosorb 106, was only 8.1-8.3% compared to the amount that was collected under the same conditions on the Quartz filter. If all contents of the Chromosorb tubes were analyzed, i.e. sorbent and fiberglass, the sorbent tubes were only 52- 60% as efficient as the fiberglass filters. The separators in the

tubes did not contain foam as shown in Figure 4 but were fiberglass. Foam separators have been shown in the past to be contaminated with a chlorinated organophosphate called Fyrol-PCF.⁷

Filter arrangements normally include a pump attached by means of a tygon tube to a cassette filter holder which can be placed in an area to be monitored. After exposure, the technician removes the cassette filter holder from the tygon tubing and covers the in, and outlets, with small plastic plugs. As this arrangement is quite cumbersome and requires the presence of a trained technician, a self-contained sampling pump and filter assembly was therefore developed and tested for use in aircraft which can be used by anyone.⁸ This air sampler is shown in Figure 6.

This patented air sampler, often referred to as the “VN sampler” has been tested and complies with the FAA regulations for use during all phases of flight (CKC).

Reference to this sampler by De Boer *et al.* in the peer reviewed journal *Chemosphere* is incorrect as they refer to the sampler as using Chromosorb 106 sorbent tubes.⁹

The VN sampler has been, and currently is, used by pilots who have experienced an abnormal smell event within the aircraft without being able to provide objective evidence that this actually occurred during flight. Pilots travel with these samplers on a stand-by basis to be activated when they sense an abnormality in the air.

Recently two samplers were returned to our lab for analysis. These samplers came from an A380, the captain of which sensed a peculiar abnormal smell. Upon analysis we identified high levels of an abnormal agent Bis(2-ethylhexyl)adipate. A search of this agent in the literature identified it as an aircraft lubricant and a plasticizer.

The results from this observation clearly show that the often-used argument by the industry, that it is virtually impossible to obtain and capture accurate data during these highly sporadic events, is faulty. To date, with only

a small number of these samplers flying across the globe on standby, we have captured a number of smell events and identified their source. Some of these were traced to hydraulic fluid, another to disinsectants overuse, a third to TCP bleed air and the current Bis(2-ethylhexyl)adipate which has not been traced to a source as yet. In order to do this one requires the cooperation of the maintenance division of the operator of this aircraft. It can be concluded from these observations that not all air quality events in the aircraft are related to bleed air. It can also be concluded that the capture of abnormal air quality in aircraft is not difficult. The frequency of abnormal events in aircraft, based on the data from van Netten,¹⁰ ranged at that time, from 0.09 to 1.29 per 1000 flight cycles, and Shehadi 2016, from 0.21 to 0.78 per 1000 flight cycles. In order to capture a large number of events, one can provide, as an example, 200 pilots with one sampler each. Assuming that each pilot, on the average, experiences two flight cycles per day, that would amount to 400 flight cycles having been monitored. After 100 days 40,000 flight cycles are monitored. Using the lowest frequency of 0.21/1000,¹¹ this would capture 8.4 events. At the higher frequency of 0.78/1000 flight cycles this would capture 31.2 events. This would provide a rich, objective, data base to help the understanding of abnormal air events in aircraft. This data, which is currently missing, can be used to provide a realistic basis for simulation experiments.

Other agents of interest that need to be monitored are gases, specifically, carbon monoxide (CO) and formaldehyde. Of these CO is the deadliest of the two as this gas causes incapacitation without warning unlike formaldehyde which is a respiratory irritant causing flu like symptoms, sore throat and headaches. Figure 7 shows the temperature dependence of the generation of formaldehyde and carbon monoxide from various oils and fluids.

Additional areas of exposure that need to be monitored

It has been observed by Yang *et al.* that airborne TCP is associated with ultrafine particulate matter, particles <0.1 nanometers.¹² This is consistent with our observations and actual measurements in our environmental chamber,



Figure 6 — Air sampler

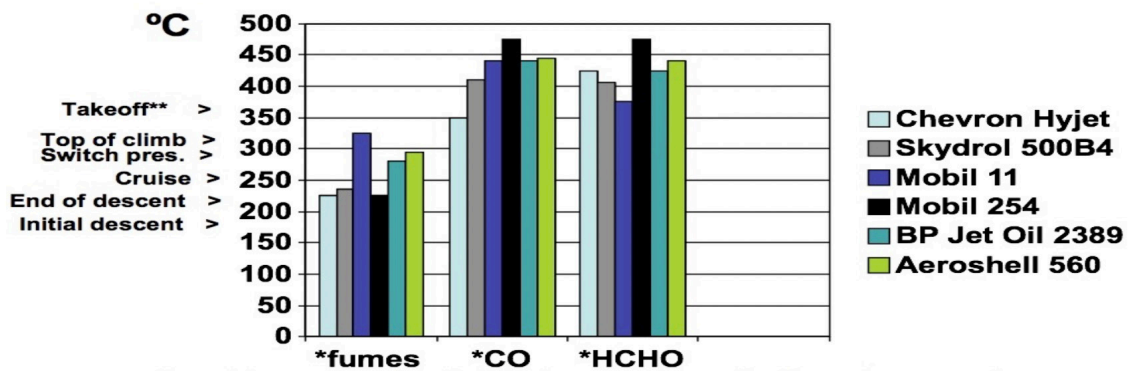

*Lowest temperature where the following parameters can be observed or measured
Fumes= visible fumes, CO = Carbon monoxide
HCHO = Formaldehyde.

**Engine temperatures during different phases of flight were obtained from: Boeing, July 13, 2001 in NAS, The Airliner Cabin Environment and the Health of Passengers and Crew, 2002,

Figure 7 — Heat stability of some hydraulic fluids and jet engine lubricating oils at 760 mm Hg

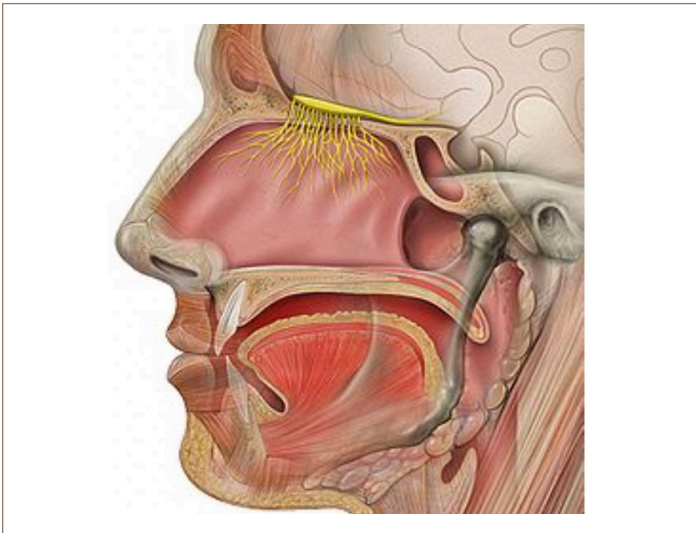

Figure 8 — The olfactory nerve

that airborne TCP exists as an aerosol and can be trapped on fiberglass filters. These nano particles can bypass the blood brain barrier by using axonal transport of the olfactory nerve.¹³⁻¹⁶ Axonal transport by the olfactory nerve has been used in medicine to deliver specific drugs to CNS targets.¹⁷

It is interesting to note that the olfactory nerve, Figure 8, ends in the olfactory tubercle which ends right at the region of the brain that is responsible for cognition, depression, and Parkinson's disease like syndromes, i.e. symptoms that have been reported by numerous pilots after exposure to alleged bleed air events.¹⁸⁻²⁰

Acknowledgments and Disclaimer

The authors wish to thank the US Aviation Administration for the use of their HP GC/MS. This research was supported with personal funds. Wipe sample analysis was paid for by BASSA.

The ideas expressed in this article are those of the author only and in no way reflect the views of agencies the author has been, or currently is, affiliated with, including FAA, AFA, EASA, NAS.

References

1. Van Netten C, Leung V. Hydraulic fluids and jet engine oil: Pyrolysis and aircraft air quality. *Arch Environ Health*. 2001;56(2):181-186. doi:10.1080/00039890109604071
2. Van Netten C, Leung V. Comparison of the constituents of two jet engine lubricating oils and their volatile pyrolytic degradation products. *Appl Occup Environ Hyg*. 2000;15(3):277-283. doi:10.1080/104732200301593
3. Hecker S, Kincl L, Mcneeley E, et al. *Cabin Air Quality Incidents Project Report*. Occupational Health Research Consortium in Aviation (OHRCA); Airliner Cabin Environment Research (ACER); 2014.
4. SKC. SKC Website. https://www.skcinc.com/catalog/product_info.php?products_id=58 <http://www.skcltd.com/index.php/sorbent-tubes/9-uncategorised/183-tenax-sorbent-tubes>. Published 2015.
5. Crump D, Harrison P, Walton C. *Aircraft Cabin Air Sampling Study; Part 1 and 2 of The Final Report: Cranfield*. Cranfield: Institute of Environment and Health, Cranfield University; 2011.
6. Houtzager M, Havermans J, Bos J. *TNO 2013 R11976- Investigation Of Presence And Concentration Of Tricresyl Phosphates In Cockpits Of KLM Boeing 737 Aircraft During Normal Operational Conditions*. The Hague: TNO; 2013.
7. van Netten C, Brands R, Park J, Deverall R. *Tri (2-Chloroisopropyl) Phosphate - An Unexpected Organochlorine Contaminant in Some Charcoal Air-Sampling Sorbent Tubes*. Vol 52.; 1991. doi:10.1080/15298669191364938
8. van Netten C. Design of a small personal air monitor and its application in aircraft. *Sci Total Environ*. 2009;407(3):1206-1210. doi:10.1016/j.scitotenv.2008.07.067
9. de Boer J, Antelo A, van der Veen I, Brandsma S, Lammertse N. Tricresyl phosphate and the aerotoxic syndrome of flight crew members - Current gaps in knowledge. *Chemosphere*. 2015;119(Suppl:S58-61). doi:http://doi.org/10.1016/j.chemosphere.119 (2015) S58-S61
10. NRC. *The Airliner Cabin Environment and the Health of Passengers and Crew.*; 2002.
11. Shehadi M, Jones B, Hosni M. Characterization Of The Frequency And Nature Of Bleed Air Contamination Events In Commercial Aircraft. *Indoor Air*. 2015;26:478-488. doi:http://dx.doi.org/10.1111/ina.12211
12. Yang F, Ding J, Huang W, Xie W, Liu W. Particle size-specific distributions and preliminary exposure assessments of organophosphate flame retardants in office air particulate matter. *Environ Sci Technol*. 2014;48(1):63-70. doi:10.1021/es403186z
13. Oberdorster G, Sharp Z, Atudorei V, et al. Translocation of inhaled ultrafine particles to the brain. *Inhal Toxicol*. 2004;16(6-7):437-445. doi:10.1080/08958370490439597
14. Peters A, Veronesi B, Calderon-Garciduenas L, et al. Translocation and potential neurological effects of fine and ultrafine particles a critical update. *Part Fibre Toxicol*. 2006;3:13. doi:10.1186/1743-8977-3-13

15. Terzano C, Di Stefano F, Conti V, Graziani E, Petroianni A. Air pollution ultrafine particles: toxicity beyond the lung. *Eur Rev Med Pharmacol Sci*. 2010;14(10):809-821.
16. Shiga H, Taki J, Yamada M, et al. Evaluation of the olfactory nerve transport function by SPECT-MRI fusion image with nasal thallium-201 administration. *Mol imaging Biol MIB Off Publ Acad Mol Imaging*. 2011;13(6):1262-1266. doi:10.1007/s11307-010-0461-3
17. Shiga H, Yamamoto J, Miwa T. *Olfactory Nerve Transport of Macromolecular Drugs to the Brain - A Problem in Olfactory Impaired Patients*. Vol 55.; 2012.
18. Coxon L. Neuropsychological assessment of a group of BAe 146 aircraft crew members exposed to jet engine oil emissions. *J Occup Heal Saf - Aust New Zeal*. 2002;18(4):313-319.
19. Abou-Donia MB, Goot FRW Van De, Mulder MFA. Autoantibody markers of neural degeneration are associated with post-mortem histopathological alterations of a neurologically injured pilot. *J Biol Phys Chem*. 2014;3(May):34-53. doi:10.4024/05AB14A.jbpc.14.03
20. Reneman L, Schagen SB, Mulder M, Mutsaerts HJ, Hageman G, de Ruiter MB. Cognitive impairment and associated loss in brain white microstructure in aircrew members exposed to engine oil fumes. *Brain Imaging Behav*. 2016;10(2):437-444. doi:10.1007/s11682-015-9395-3

Use of Exposure Standards in Aviation

Andrew Watterson, Susan Michaelis

University of Stirling, Stirling, UK

Corresponding author:

Andrew Watterson

a.e.watterson@stir.ac.uk

KEYWORDS

occupational exposure limit, expose standards, hypoxic environment, bleed air

ABBREVIATIONS

TCP	Tricresyl phosphate
OEL	Occupational exposure limit
TLV	Threshold limit value

ABSTRACT

The use of occupational exposure limits and threshold limit values in the aircraft environment is examined in relation to aircraft air supplies contaminated by engine oils, hydraulic and other fluids used in aircraft.

INTRODUCTION

In recent years there have been an increasing number of aircraft air quality studies either in the cabin air or the bleed air supply. These have very often suggested that the levels are better than in homes, offices, schools and are below regulated standards and occupational exposure limits. Several examples follow:

- UK Department of Transport study (2011): *“There was no evidence for target pollutants occurring in the cabin air at levels exceeding available health and safety standards and guidelines.”*¹
- ACER/ASHRAE (2012) *“The air quality and environmental conditions in the passenger cabin of commercial airplanes are comparable or better than conditions reported for offices, schools and*

*residences, with a few exceptions.”*²

- EASA (2017): *“The results show that the cabin/cockpit air quality is similar or better than what is observed in normal indoor environments (offices, schools, kinder gardens or dwellings). No occupational exposure limits and guidelines were exceeded.”*^{3,4}
- KLM/TNO (2017): *“Exposure to [tricresyl phosphate] TCP was evaluated against internal exposure limits. It was concluded that the calculated exposure was below these limits, with one exception.”*⁵
- Industry study (2018): *“The maximum concentrations of TCP detected in this study were less than 2 ug/m³ for the reported single events and less than 0.05 ug/m³ for non-event flights, which is far below the occupational exposure limit (OEL) of 100 ug/m³ and the threshold limit value (TLV) of 20 ug/m³, which was most recently derived for the more toxic ToCP”* by the ACGIH.⁶

The application of the various occupational exposure limit (OEL) thresholds and comparison to other environments however requires careful review. To put the use of exposure limits in context, US based threshold limit values (TLVs) *“have been, and still are, the most influential OELs in the world,”*⁷ and are commonly used internationally as a source for national OEL recommendations.⁸

Use of threshold limit values (TLVs)

The American Conference of Governmental Industrial Hygienists,⁹ a non-governmental scientific association, propose guidelines known as threshold limit values (TLVs) for use by industrial hygienists in making decisions regarding safe levels of exposure to various hazards found in the workplace.

The ACGIH are not a standards setting body, however they provide a number of guidelines on how the proposed thresholds limit values should be used.⁹ These include that TLVs are: not regulatory or consensus standards; should only be used by people trained in industrial hygiene; one of multiple factors to be considered; health based limits that nearly all workers

may be repeatedly exposed to without adverse effects; not fine lines between safe and dangerous; not an indicator of toxicity, disease, adverse effects; some individuals may experience discomfort or more serious adverse effects at or below the threshold limit. Reasons for increased individual susceptibility may include age, gender, ethnicity, genetic factors, lifestyle choices, medications and pre-existing medical conditions. Some individuals (e.g. sensitized workers) may become more responsive to one or more chemical substances following previous exposures and altered effects may occur during different periods of fetal development and throughout an individual's reproductive lifetime. Changes in susceptibility may occur at different work intensity when there is a differing cardiopulmonary demand.

TLVs are related to airborne concentrations and are not to be used for extended periods or for non-workers, or for proving or disproving a disease in an individual. Air sampling may be insufficient to quantify skin exposure levels.

Sampling results obtained under unusual conditions (normal is 25C, 760 torr barometric pressure at MSL) cannot easily be compared to published TLVs, and extreme care should be exercised if workers are exposed to very high or low ambient pressures. Unusual work schedules greater than eight hours per day require particular care when applying TLVs. TLVs are only available for limited substances and not all are up to date.

Importantly TLVs apply to single substances, with special consideration required to be given to the application of TLVs in assessing health hazards that may be associated with a mixture of two or more substances. The TLV additive formula is not applicable to complex mixtures with many components such as thermal decomposition products. No physiological effects of oxygen deficiency are expected at oxygen partial pressures > 132 torr or below 5000 feet as shown in Figure 1.

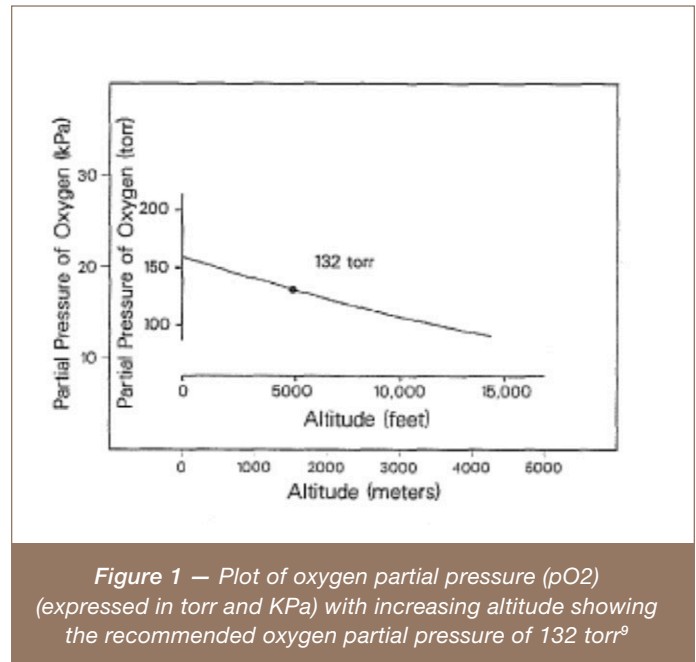

Use of other occupational exposure limits

Guidelines on the use of OELs used internationally are very often difficult to source with the OELs often not binding and with very few updated. Questions on their application arise when flying over different states or countries. As an example, the UK based work exposure limits are only applicable between 900-1100 mb, equivalent to 3241 feet to minus 2290 feet.

Use of OELs/ TLVs in the aviation occupational setting

There is wide awareness within the aviation industry and associated sectors that OELs /TLVs should not be applied to the aircraft cabin environment. A few examples applicable to the use of OELs/TLVs as well as the specific case of the use of the threshold limit used for one specific chemical are cited below.

1. Use of exposure limits in aircraft environment
 - Aerospace Medical Association: "OSHA standards (and others throughout the world) are not applicable to aircraft cabin air. Rather they were designed for the industrial workplace."¹⁰
 - Industry: "The airliner cabin is a unique environment

since it is simultaneously occupied by passengers (ie: a segment of the general public) and flight attendants (ie: a segment of the worker population). The standards and guidelines for public exposure are more stringent than occupational levels. Thus it is not appropriate to use occupational standards or guidelines as criteria for the cabin environment.”¹¹

- ASHRAE: “Except for industrial workplaces and certain specialized environments, such as spacecraft, indoor air quality standards do not exist for most indoor or confined environments, including aircraft cabins.”¹²
- SAE: “Occupational and public exposure limits apply only to exposures to a single chemical at a time. They do not reflect the actual situation in aircraft cabins, where contaminants may be present in a blend, and the possible effects of altitude on toxicity mechanisms. Also, exposure standards or limit values do not exist for all chemical species, or the various possible isomers.”¹³
- Manufacturer: “Existing standards also do not address the specific environment of the aircraft cabin in detail, if at all. The aircraft cabin environment is unique when compared to other indoor spaces...”¹⁴
- EASA: “The conditions in cabin air may differ from the standard conditions on which exposure limits are normally based, for example the air pressure, humidity and longer working hours. These aspects need further consideration. In addition, also possible effects relating to mixture toxicology need further investigation.”¹⁵
- Industry: “Typical concentrations found in aircraft can cause transitory symptoms in healthy individuals questioning the adequacy of current standards.”¹⁶
- UK House of Lords: “What exposure standards currently apply to any synergistic effects of simultaneous exposure to numerous chemicals which may be experienced by aircraft passengers and crew during a contaminated air event in a reduced pressure environment? Answer: None”¹⁷

2. Application of exposure limits—general

- HSE: “WELs are British occupational exposure limits

and are set in order to help protect the health of workers...WELs are approved only for application to people at work”¹⁸

- FAA: “The chemicals found in the carbonaceous material may not necessarily be individually toxic at the found concentrations, but if they are mixed together at those concentrations, the mixture might be highly toxic.”¹⁹
- ## 3. Use of exposure limit for tri-ortho-cresyl-phosphate (TOCP)
- Mobil: “One might incorrectly imply that TOCP standards are adequately protective for products containing TOCP. However, TCP consists of a mixture of isomers.... This calls into question the adequacy of exposure standards which rely only upon the evaluation of the concentrations of the tri-o-isomer of TCP in the atmosphere. It is possible that the standard promulgated by US OSHA has been based upon the assumption that the tri-o-isomer was primarily or solely responsible for the neurotoxic properties of TCP.”²⁰
 - Mobil: “There was very little difference between the activities of TCP & TOCP.....We are under the impression that a commonly held opinion is that TCP with TOCP levels below 1% is not neurotoxic. Our results indicate that TOCP level in TCP is not a reliable indicator of potential neurotoxicity.... There is confusion over the appropriateness of using the TOCP level as an indicator of neurotoxic potential. After considering the weight of all available evidence, both published and our new data, we concluded that EPA and other users of TCP as a lubricant additive should be informed of our results.”²¹
 - Scientist: ““Previous calculations of the toxic human dose were based on the amount of ortho cresol contained in a preparation and related this amount to TOCP, in belief that the bound proportions of meta-cresol and para-cresol have no effect on the toxicity of the total preparation. However since the meta and para isomers that are present can cause the formation of the mono-ortho and diortho esters.... The toxicity of the mixed esters is much greater than

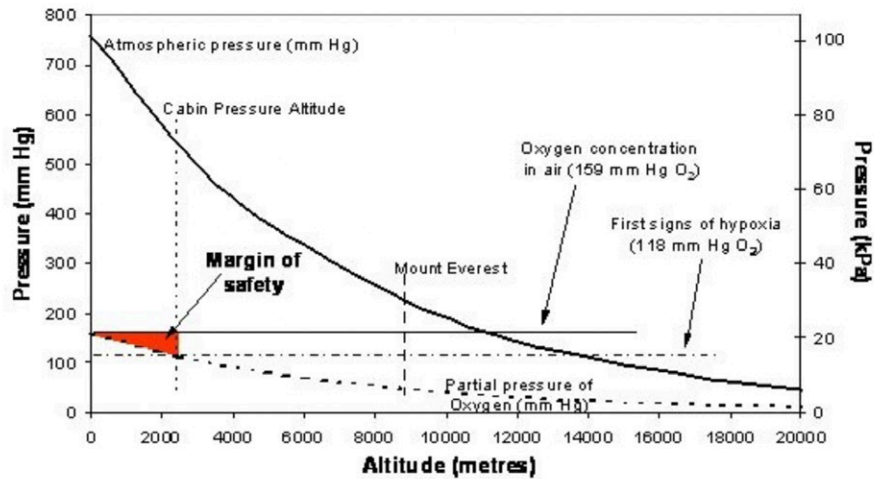

Figure 2 — Pressures and oxygen concentrations at altitude²⁴

the TOCP, the old method of calculation, is invalid.”²²

- WHO: “Because of considerable variation among individuals in sensitivity to TOCP, it is not possible to establish a safe level of exposure ... Both the pure ortho isomer and isomeric mixtures containing TOCP are, therefore, considered major hazards to human health.”²³

Hypoxic environment

The minimum oxygen concentration for work is around 136 mm Hg O₂ in air at sea level. A minimum partial pressure of oxygen of 118 mm Hg (equivalent to an altitude of around 8000 feet/ 2438 m), is required to prevent the aircraft cabin becoming hypoxic during normal operations. There is little margin of safety in people working at altitude and as such workers may be beginning to become hypoxic (Figure 2).²⁴

On-going industry position

Despite the clear appreciation on how exposure limits should be used and the limitations regarding their use in the aviation setting, many working within the aviation industry continue to rely on the use of measurements referenced to OELs and TLVs. For example the current

European FACTS cabin air quality study describes the main purpose being to investigate the quality of the air and the impact on crew and passenger health “in light of the relevant European legislation on the quality of indoor air and professional exposure limits.”^{25,26} A focus continues to remain on TCP and ToCP rather than the complex mixture.^{6,27,28} Although there are no OELs or TLVs for the non ortho isomers of TCP it is still suggested that the “The TCP concentrations (para and meta isomers only) detected on all investigated flights were well below the internationally established toxicological thresholds for harm to human health.”¹⁶

Complex mixtures

The inappropriate reliance on exposure limits and thresholds, rather than the complex mixture has been increasingly recognized. Exposure to mixtures of contaminants well below levels recommended in currently available exposure standards may still generate adverse effects as the contaminants can act in synergy or the standards may not have incorporated more recent scientific or medical evidence.²⁹ The application of conventional occupational health and safety procedures to the specialized aircraft environment are inappropriate.²⁹

The use of a 'one chemical at a time' approach, rather than focusing on the toxicology of complex mixtures will not address human health problems being identified in the aircraft cabin.³⁰

CONCLUSIONS

Threshold limit values and occupational exposure limits should not be applied to the aircraft cabin environment, particularly in relation to aircraft contaminated ventilation air supplies, commonly known as bleed air. This environment is subject to reduced partial pressure of oxygen and involves complex heated mixtures. The environment is unique without the possibility to escape and is one in which both passengers and aircrew are present. The aircraft cabin should not be compared to ground-based workplaces. Avoidance under the hierarchy of controls should be a key factor considered.

References

1. Crump D, Harrison P, Walton C. *Aircraft Cabin Air Sampling Study; Part 1 and 2 of The Final Report*. Cranfield: Institute of Environment and Health, Cranfield University; 2011.
2. Spengler J, Vallarino J, Mcneely E et al. *RITE-ACER-CoE-2012-6. In-Flight / Onboard Monitoring : ACER 's Component for ASHRAE, 1262, Part 2*. Boston: RITE/ACER; 2012.
3. EASA. Press release: CAQ - Preliminary cabin air quality measurement campaign EASA_REP_RESEA_2014_4: <https://www.easa.europa.eu/document-library/research-projects/easarepresea20144>. Published 2017.
4. EASA. *Research Project : CAQ Preliminary Cabin Air Quality Measurement Campaign. Final Report EASA_REP_RESEA_2014_4*. Cologne: European Aviation Safety Agency; 2017. https://www.easa.europa.eu/system/files/dfu/EASA_CAQ_Study_Final_Report_21.03.2017.pdf.
5. de Ree H, Agterberg H, Houtzager M, et al. Exposure of Airline Staff to TCPs from Engine Oil. LV-17-C045. In: *2017 ASHRAE Winter Conference—Papers*. ; 2017:1-8.
6. Schuchardt S, Koch W, Rosenberger W. Cabin air quality – Quantitative comparison of volatile air contaminants at different flight phases during 177 commercial flights. *Build Environ*. 2019;148:498-507. doi:10.1016/j.buildenv.2018.11.028
7. Piney M. *OELs and the Effective Control of Exposure to Substances Hazardous to Health in the UK (Version 3)*; 2001.
8. Winder C. Misuse of the exposure standard concept: editorial. *J Occup Heal Saf Aust New Zeal*. 1998;14(2):p107-110.
9. ACGIH. *TLVs and BEIs - Threshold Limit Values For Chemical Substances And Physical Agents*. Cincinnati: American Conference of Governmental Industrial Hygienists; 2015.
10. Rayman R. Cabin Air Quality: An Overview. *Aviat Sp Environ Med*. 2002;73(3):211-215.
11. Nagda N, Rector H, Li Z, Space D. Aircraft cabin air quality: A critical review of past monitoring studies. In: Nagda N, ed. *Air Quality & Comfort in Airliner Cabins, ASTM STP 1393*. West Conshohocken, PA: American Society for Testing and Materials; 2000.
12. ASHRAE. *Standard 161-2013. Air Quality Within Commercial Aircraft*. Atlanta: ASHRAE; 2013.
13. SAE. *AIR 4766/2- Airborne Chemicals In Aircraft Cabins*. Warrendale: Society of Automotive Engineers; 2005.
14. Dechow M, Nurcombe C. Aircraft Environmental Control Systems. In: Hocking M, ed. *Air Quality in Airplane Cabins and Similar Enclosed Spaces*. Vol 4H. The Handbook of Environmental Chemistry. Berlin: Springer; 2005:3-24.
15. EASA. *Research Project: AVOIL. Characterisation of the Toxicity of Aviation Turbine Engine Oils after Pyrolysis. Final Report EASA_REP_RESEA_2015_2*. Cologne: European Aviation Safety Agency; 2017. <https://www.easa.europa.eu/the-agency/procurement/calls-for-tender/easa2015hvp23>.
16. Weisel CP, Fiedler N, Weschler CJ, et al. Human Symptom Responses To Bioeffluents, Short-Chain Carbonyls/Acids and Long-Chain Carbonyls in a Simulated Aircraft Cabin Environment. (Boeing/FAA ACER funding). *Indoor Air*. 2017;38(1):42-49. doi:10.1111/ijlh.12426
17. House of Lords. *Hansard Question: Countess of Mar [HL 1761], October 2005*. London: House of Lords, Parliament of the UK; 2005.
18. HSE. *EH40 / 2005 Workplace Exposure Limits EH40 / 2005 Workplace Exposure Limits (as Amended)*. UK: Health and Safety Executive; 2011:1-74.
19. Chaturvedi A. *DOT/FAA/AM-09/8. Aerospace Toxicology: An Overview*. Oklahoma City: Federal Aviation Administration, CAMI; 2009.
20. Craig PH, Barth ML. Evaluation of the hazards of industrial exposure to tricresyl phosphate: a review and interpretation of the literature. *J Toxicol Environ Health B Crit Rev*. 1999;2:281-300. doi:10.1080/109374099281142
21. Mobil. *Letter from Mobil Research and Development Corporation to US EPA- Notification of Tricresyl Phosphate (TCP) - July 21, 1988*; 1988.
22. Henschler D. Die Trikresylphosphatvergiftung. Experimentelle klärung von problemen der ätiologie und pathogenese (Tricresyl phosphate poisoning. Experimental clarification of problems of etiology and pathogenesis). *Klin Wochenschrifte*. 1958;36(14):663-674.
23. WHO. International Programme On Chemical Safety (IPCS). Tricresyl Phosphate -Environmental Health Criteria 110.

- 24.** Winder C, Balouet J-C. The toxicity of commercial jet oils. *Environ Res.* 2002;89(2):146-164. doi:10.1006/enrs.2002.4346
- 25.** European Commission. *Call for Tenders N° MOVE C2/2016-363 -Research Study: Investigation of the Quality Level of the Air inside the Cabin of Large Transport Aeroplanes and Its Health Implication. Tender Specifications.* Brussels: European Commission - DG Mobility and Transport; 2016.
- 26.** EASA-EU Commission. FACTS- Aircraft air quality study. 2017. <https://www.facts.aero/index.php/approach>.
- 27.** de Ree H, van den Berg M, Brand T et al. Health Risk Assessment Of Exposure To TriCresyl Phosphates (TCPs) In Aircraft: A Commentary. *Neurotoxicology.* 2014;45:209-215.
- 28.** Wolkoff P, Crump DR, Harrison PTC. Pollutant exposures and health symptoms in aircrew and office workers: Is there a link? *Environ Int.* 2016;87:74-84. doi:10.1016/j.envint.2015.11.008
- 29.** Winder C. Hazardous Chemicals on Jet Aircraft : Jet Oils and Aerotoxic Syndrome. *Curr Top Toxicol.* 2006;3:65-88.
- 30.** Howard C V, Johnson DW, Morton J, Michaelis S, Supplee D, Burdon J. Is a Cumulative Exposure to a Background Aerosol of Nanoparticles Part of the Causal Mechanism of Aerotoxic Syndrome ? *Nanomedicine Nanosci Res.* 2018;139(1). doi:10.29011/JNAN-139.

Mind the Gap? Identifying, Managing and Preventing Some Aircraft Crew Occupational Health and Safety/Flight Safety Problems

Andrew Watterson, Susan Michaelis

University of Stirling, Stirling, UK

Corresponding author:
Andrew Watterson
a.e.watterson@stir.ac.uk

KEYWORDS

crew health, organophosphate, regulations, cabin air, memorandum of understanding

ABBREVIATIONS

CAA	Civil Aviation Authority
OP	Organophosphate
MOU	Memorandum of understanding

ABSTRACT

The paper explores a number of obstacles to and key approaches on the recognition and management of occupational health problems, relevant inter-actions and possible multi-causality in the context of aircraft crew health and safety. The dominant approach has all too often been – ‘don’t look, don’t find, where is the problem?’ Control and removal of these problems has failed even where there is a regulatory system that theoretically applies the standard occupational health and safety management hierarchy. Some solutions to address this failure and examples of good practice both within Europe and internationally are then identified and analyzed.

INTRODUCTION

The identification of occupationally-caused and occupationally-related diseases is all too often a very lengthy process. This impacts on official recognition, prescription and scheduling of the disease by governments, compensation for victims and most importantly preventative actions. The result is that

those with occupational diseases from a process or product are often left behind decades after an industry/occupation and its materials and technology change or cease. The dominant approach to many occupational diseases has all too often been – don’t look (or don’t have the means to look), don’t find (or don’t have the means or knowledge to make sense of findings or omit crucial findings), where is the problem – and in the process important information from crew can be discounted or simply dismissed as ‘hysteria? Sometimes the techniques to identify potential problems or make sense of a variety of data relating to them have been lacking. National health and safety regulations are usually underpinned by basic principles of removing hazards at source and, if that is not possible, adopting a hierarchy of approaches linked to substitution of less hazardous materials, isolation, engineering controls and personal protective equipment. Yet these principles have sadly all too often been subverted by industry, governments and complicit or captured regulators as the former head of the United States Occupational Safety and Health Administration, David Michaels, has carefully and recently documented.¹

Table 1 illustrates how such approaches have either crudely or at times in a more subtle manner been adopted to air quality threats to crew linked to their possible organophosphate exposures (OPs).^{2,3}

This is against a backdrop of a range of aviation regulations, standards and guidance material dealing with cabin air quality affecting crew and passengers in various ways. Examples of these include CS/FAR 1309 Equipment and Systems Design – Airframe: CS E510.... FAR 33.7 – Safety analysis engine/APU – Bleed air- Incapacitation /Impairment; CS E 690.... – Bleed air purity engines & APU; CS & FAR 25.831 a/b - Airworthiness - Ventilation and Heating (CO, CO₂, O₃); AMC 21.A.3B(b) – Unsafe condition – Impairment/discomfort – Increased frequency; (EU) 2015/1018 - Reporting; for example on contaminated air- could endanger aircraft/occupants. In addition, a range of occupational or occupationally-related regulation on health and safety within the EU either apply or would

Cut information

- Ignore studies on chemical exposures 1950s-2000 and lessons from long history of OP research linked to application of caution and vulnerable groups
- Downplay complex mixture interactions
- Ignore or downplay science on very low level exposures
- Ignore or downplay incident reports
- Fail to explore alternative engineering and materials approaches to problems
- Underestimate exposure times of crew
- Ignore 'false negatives' trap linked to limited epidemiology

Stretch information

- Exaggerate extent to which existing limited research has addressed problems
- Over-estimate general responses to OPs and miss vulnerable groups in non-acute exposures
- Argue occupational diseases are psychological/psychiatric in origin
- Indicate no problems and have no adequate means to check if there are any
- Set up reporting schemes for incidents but fail to fully investigate reports

Table 1 – The Procrustean Regulatory and Policy Approach to Assessing Air Cabin Quality Threats Relevant to OHSM?

be relevant to aircrew and passengers on the ground and perhaps in the air in some circumstances. These include the following directives: the OSH Framework Directive EU 89/391; Directive – EU 98/24/EC – chemical agents; Directive – 2004/37 EC – Carcinogens; Directive – 2000/79/EC – Working time- mobile workers – mobile staff in civil aviation will have safety and health protection appropriate to the nature of their work.

DISCUSSION

To what extent can such regulations, directives and guidance be applied to cabin air, at what stages in a plane's travel from one airport to another? Can they be enforced? Are they enforced? How does inter-agency collaboration work when covering different stages of 'flight'? Do agencies have the knowledge, skills, staff, resources and time to enforce? The answers to these questions are not fully available and can vary depending upon who provides the information. Mechanisms exist to do this depending on interpretation and application of guidance as for example Figure 1 which illustrates the UK and Northern Ireland memorandum of understanding (MOU) with the CAA and related guidance.^{4,5}

The MOU is only as effective as its scope and application. The Civil Aviation Authority (CAA), the aviation regulator, takes the aviation health and safety lead and provides advice to Government/media/passengers on health issues which must present staff at times with potential conflicts of interest because government and passenger interest can conflict. The CAA would be expected to assess dermal and inhalation exposures and altitude and exposure issues. It may be offered technical expertise by others working and researching in the field as for example happened with free blood testing, but such offers have been turned down. Effectively there appears to some to be an opaque if not closed loop between for example CAA, HSE Public Health England, EASA, the UK Committee on Toxicity (COT) and the Industrial Injuries Advisory Council on air quality advice and information used and any recognition of occupational ill-health due to cabin air. The HSE will cover non-air crew workers who are on the ground and have no intention of flight but can raise concerns with CAA when aircraft are in GB airspace. To outside observers, it seems they are given lesser priority where other regulators are better placed.

Under the 2008 MOU, there has been to our knowledge



Memorandum of Understanding between the Health and Safety Executive, Health and Safety Executive Northern Ireland and the Civil Aviation Authority for aviation industry enforcement activities

In general, HSE, HSENI and CAA have jurisdiction over the following areas:

CAA	HSE	HSENI
<ul style="list-style-type: none"> Aviation safety activities covered by the Civil Aviation Act 1982 Air Navigation Order 2016 Civil Aviation (Working Time) Regulations 2004 	<ul style="list-style-type: none"> Work activities covered by the Health and Safety at Work etc. Act 1974 and its relevant statutory provisions <p><i>Management of Health and Safety Regulations</i> <i>CPL Regulations 1272/2008</i></p>	<ul style="list-style-type: none"> Work activities covered by the Health and Safety at Work (Northern Ireland) Order 1978 and its relevant statutory provisions

CAP 1484

Chapter 1: CAA and HSE safety duties and interface arrangements

Subject	CAA safety and airspace regulation group	CAA aviation health unit	CAA aviation occupational health and safety	HSE
Exposure to hazardous substances within the aircraft	Effect of substances on ability of crewmembers to operate the aircraft. Safe flight and landing.	Advice to Government and others on the possible health implications of exposure to hazardous substances on crew and passengers.	Risks to occupational health and safety to crew members from exposure to hazardous substances are being adequately controlled on board the aircraft.	Risks to occupational health and safety of non-crew members are being adequately controlled.

March 2017

Page 14

Figure 1 — UK and Northern Ireland Memorandum of Understanding between HSE, HSENI and CAA and Memorandum of Understanding Guidance. (Text in italics represents authors contribution)

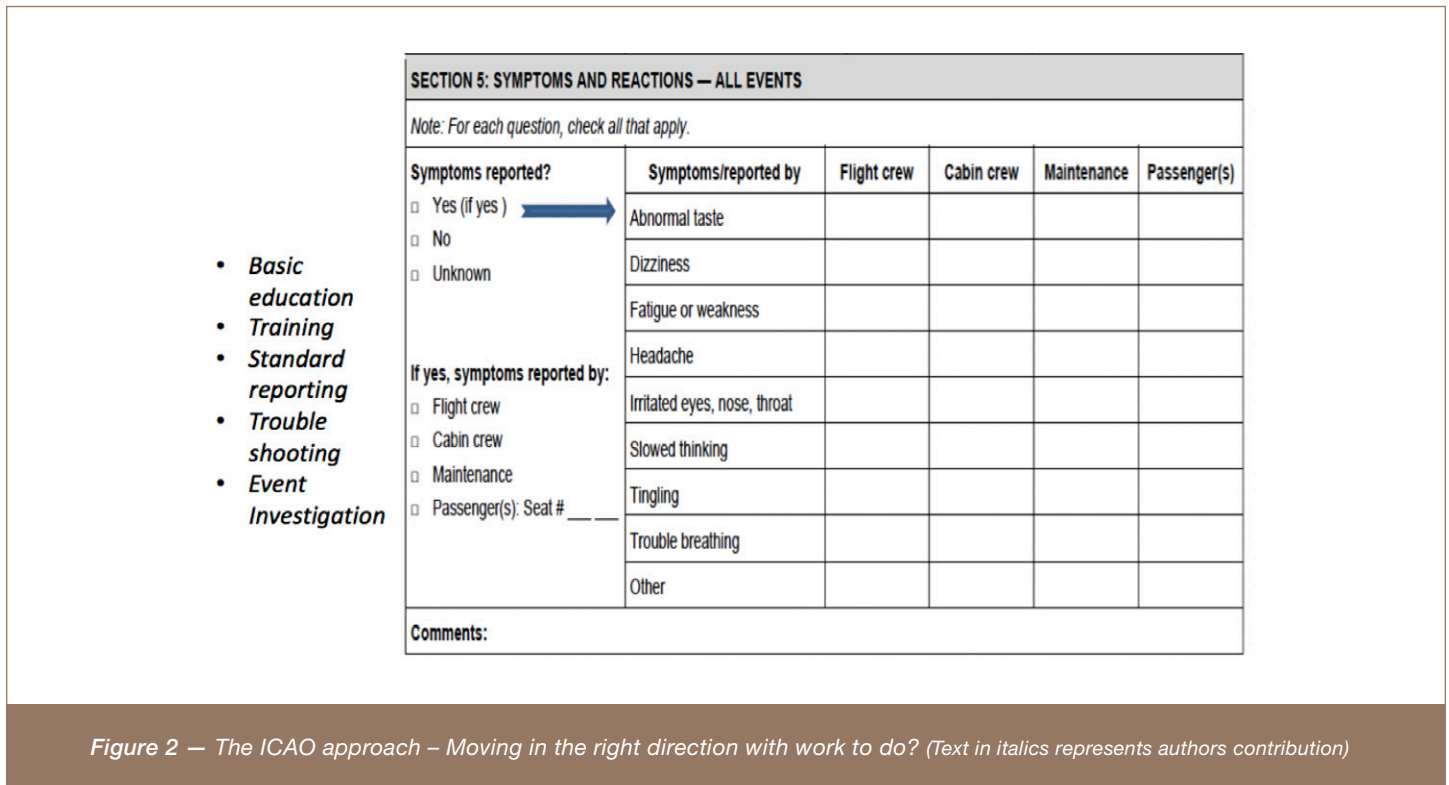

Figure 2 — The ICAO approach – Moving in the right direction with work to do? (Text in italics represents authors contribution)

no or no effective Control of Substances Hazardous to Health Regulations enforcement by HSE or CAA enforcement of the Working time regulations relating to chemical exposure. Workplace exposure standards for chemicals used by HSE in the UK would not be applicable in flight which is a major concern especially with effects of complex mixtures at altitudes above 5000 feet.

What should be done to fix the many gaps in regulatory oversight, transparency, information, accessibility and flow, occupational disease recognition and monitoring, standard setting, application, effective occupational and environmental hygiene controls, design, inter-agency cooperation and effective coverage of air crew, passengers and ground crew with regard to chemicals and processes known to cause or suspected to cause cabin air pollution? Better application of existing laws and regulations and their logical extension to air as well as ground exposures could be done partly through well resourced, trained and staffed regulators being

more active in monitoring and enforcement and also through tweaking existing regulations. Such an approach should be cost effective as well as raising health and safety standards for both workers in the industry and passengers as knowledge of exposures to toxic chemicals in the industry grows.

In addition, building on, properly evaluating and applying widely the good practice on occupational health and safety management systems that is developing for the industry under such initiatives as the ICAO's Guidelines on Education, Training and Reporting Practices related to Fume Events 2015 will be valuable (Figure 2).⁶

It must of course not be viewed as a tick box exercise but lead to action at all appropriate levels where problems are identified. It would underpin the proposed improved regulatory framework and mechanisms. The OHSAS 18001 that incorporated key aspects of ISO 45001 which now replaces it as the new international standard for occupational health and safety indicated

some necessary generic features for raising health and safety standards relevant to cabin air.⁷ These include effective systems integration and greater attention to worker ‘wellness’ and collection of occupational health data linked to increasing crew participation, recording and perceptions. Evidence suggests that all too often the critical resource of air crew on fume incidents has been marginalized or dismissed rather than used in ways that OHSAS indicates. In addition, the approach requires a linkage to mechanisms to improving responses on technology and materials; increasing attention paid to suppliers, contractors and health and safety bodies relevant to issues identified; identifying substances with known/ potential risks to human health at various levels; ongoing and new hazard identification activity including non-routine as well as routine work and product design and emergency situations such as a ‘fume’ incidents.

What is clear, however, is that the issue has been seriously neglected all too often by industry and regulators at both national and international level. Only the actions of individual pilots and cabin crew and their trade union and professional bodies in the first place over many years have led to recognition of the problem that only now are beginning to increase recognition of the issue.⁸⁻¹⁰

Our_work/About_us/Files/HSE CAA Memorandum of Understanding.pdf.

6. ICAO. *Cir 344-AN/202. Guidelines on Education, Training And Reporting Practices Related To Fume Events*. Montréal: International Civil Aviation Organization; 2015.
7. British Standards Institute (nd). *BS OHSAS 18001. Occupational Health and Safety Management*. <https://www.bsigroup.com/en-GB/ohsas-18001-occupational-health-and-safety/>.
8. EASA. *Research Project : CAQ Preliminary Cabin Air Quality Measurement Campaign. Final Report EASA_REP_RESEA_2014_4*. Cologne: European Aviation Safety Agency; 2017. https://www.easa.europa.eu/system/files/dfu/EASA_CAQ_Study_Final_Report_21.03.2017.pdf.
9. WSOCTV. 9 Investigates: Toxic air on board passenger jets - March 6, 2017. 2017. <http://www.wsocvtv.com/news/9-investigates/today-at-5-toxic-air-onboard-passenger-jets/498575431>.
10. Loraine T. How Safe Is Your Cabin Air? “Toxic air on planes is a danger for passengers.” *Daily Telegraph*. <http://www.telegraph.co.uk/travel/news/How-Safe-Is-Your-Cabin-Air-Toxic-air-on-planes-is-a-danger-for-passengers/>. Published June 18, 2015.

References

1. Michaels D. *Doubt Is Their Product: How Industry’s Assault on Science Threatens You Health*. Oxford: Oxford University Press; 2008.
2. Loomis T, Krop S. *MLSR No. 61 - Cabin Air Contamination In RB-57A Aircraft*. Maryland: Army Chemical Center; 1955.
3. Winder C, Balouet J. *Aerotoxic Syndrome : Adverse Health Effects Following Exposure To Jet Oil Mist During Commercial Flights*. In: Eddington I, ed. *Towards a Safe and Civil Society. Proceedings of the International Congress on Occupational Health Conference. 4-6 September, 2000. Brisbane*. Vol ICOH; 2000.
4. CAA, HSE, HSENI. *CAA/HSE/HSENI Memorandum of Understanding Guidance: CAP 1484*.; 2017. https://publicapps.caa.co.uk/docs/33/CAP_1484_MAR17.pdf.
5. HSE, HSENI C. *Memorandum of Understanding Between The HSE, HSENI and CAA for Aviation Industry Enforcement Activities*.; 2016. https://www.caa.co.uk/uploadedFiles/CAA/Content/Standard_Content/