

6th CIRP Global Web Conference
“Envisaging the future manufacturing, design, technologies and systems in innovation era”

Machining of Micro Dimples for Friction Reduction in Cylinder Liners

B. Denkena; T. Grove; C. Schmidt*

Leibniz Universität Hannover, Institute of Production Engineering and Machine Tools, An der Universität 2, 30823 Garbsen, Germany

**Corresponding author. Tel.: +49 (0)511 - 76219372; fax: +49 (0)511 - 7625115. E-mail address: schmidtch@ifw.uni-hannover.de*

Abstract

In combustion engines a large percentage of mechanical losses result from friction, for example within the cylinder liner. In order to reduce the friction between cylinder liner and piston, micro dimples in the surface decrease the internal friction of combustion engines. These dimples hold back lubricant from being pressed out of the tribological contact zone which enhances the friction behaviour. Competing processes such as laser material removal allow micro dimples to be generated at high productivity. Therefore the process time of machining micro dimples needs to be reduced in order to maintain low production costs. For this purpose a rotating single-toothed tool is used in an axially parallel turn-milling process. The aim of this paper is to show the investigation of productive machining and the effect of the micro dimples in heavy duty cylinder liners. The cutting behaviour is investigated by analyzing micro dimples cut at high speed concerning their burr formation and geometrical deviations.

© 2018 The Authors. Published by Elsevier B.V. This is an open access article under the CC BY-NC-ND license

(<https://creativecommons.org/licenses/by-nc-nd/4.0/>)

Selection and peer-review under responsibility of the scientific committee of the 6th CIRP Global Web Conference “Envisaging the future manufacturing, design, technologies and systems in innovation era”.

Keywords: Micro Dimples; Engine Friction; Cylinder Liner; Turn-milling

1. Introduction

In today's combustion engine development much effort is invested in topics related to efficiency. This includes the reduction of friction losses within the piston group, which consists of cylinder liner, piston and piston rings. As the contact area between piston rings and cylinder liner sums up to 50 % of the engine's friction losses, this tribological system offers a high potential for an efficiency-increase [1]. The friction of this system can be reduced by the application of micro dimples on the liner surface. As these micro dimples influence the lubrication condition in the piston group, they show negative or positive effects depending on their location in the piston's stroke direction. The micro dimples hold back lubricant from being pushed out of the contact zone, which leads to a tribological improvement in mixed friction at low relative speeds [2; 3]. However, at higher speeds, which occur in the middle part of the liner, micro dimples impair the hydrodynamic friction by increasing the lubricant film

thickness that leads to higher hydrodynamic friction. These effects are generated on a single cylinder research engine test rig that is equipped with a crank angle resolved floating-liner measurement system [4].

This paper discusses the current results of the process development that focuses on the machining process's productivity increase.

1.1 Approach and experimental setup

The investigated micro dimples are machined by an axially parallel turn-milling process on the Gildemeister CTX 520 lathe at the Institute of Production Engineering and Machine Tools (IFW) and tested on a Floating-Liner system at the Institute for Technical Combustion (ITV) at Leibniz Universität Hannover. Moreover, cutting experiments concerning the effect of different cutting speeds are conducted on plane workpieces using a DMG DMU125 milling center. The tests on plane workpieces allow the analysis of micro dimples in a more

detailed way as no measurement on the inside of a cylindrical workpiece is necessary.

Nomenclature

n_t	rotational speed of the tool
n_{wp}	rotational speed of the workpiece
λ	rotational ratio of n_t to n_{wp}

2. Machining of micro dimples in cylinder liners

Various production processes can generate microscopic structures such as dimples on the inner surface of a cylinder liner. The common industrially used methods to generate micro dimples are laser material removal and thermal spraying of porous layers. These processes are highly productive [5; 6]. However, they are not able to generate a surface that is ready to use. Both need at least a finish-honing process as a following step in the cylinder liner’s process chain [7]. Another, yet less productive possibility is machining micro dimples with cutting tools [8]. In contrast to other processes, micro dimples can be machined by cutting processes that are located at the end of the process chain after the finish-honing. This is because the burr-generation at the micro dimples’ edge, which is a central issue in laser material removal, can be avoided by the adaption of the cutting process. Furthermore, the application of cutting processes being performed on standard machine tools avoids the necessity of laser- or spraying equipment [9].

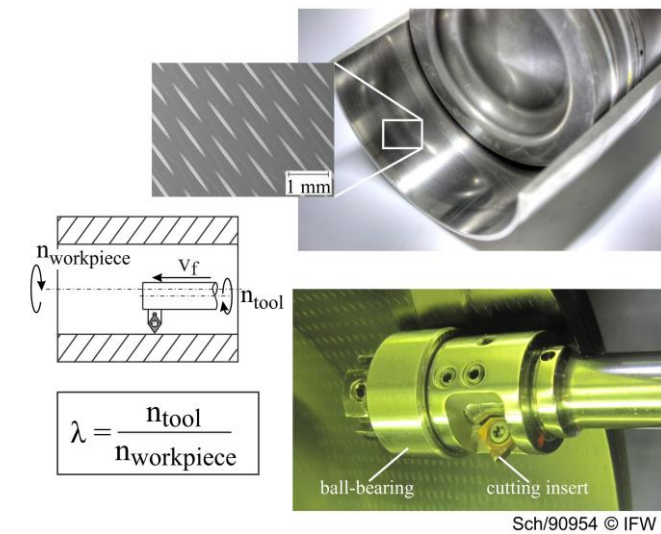

Fig. 1: Process principle and examples for machining micro dimples

An axially parallel turn-milling process with a single-toothed milling tool is used to cut micro dimples on finish-honed cylinder liners. Fig. 1 shows the process’s kinematics and the tool. The casted GJL250 test cylinders have an inner diameter of 130 mm and a length of 240 mm. In order to machine all areas of the liner in axial direction, the tool’s length is 140 mm. Micro dimples are generated by a single tool engagement as shown in Fig. 2. For this reason both, workpiece (cylinder liner) and milling tool, need to rotate in a defined rotational ratio λ of n_t to n_{wp} . By a variation of the tool’s rotational speed and its diameter, the number and geometry of the micro dimple can be set.

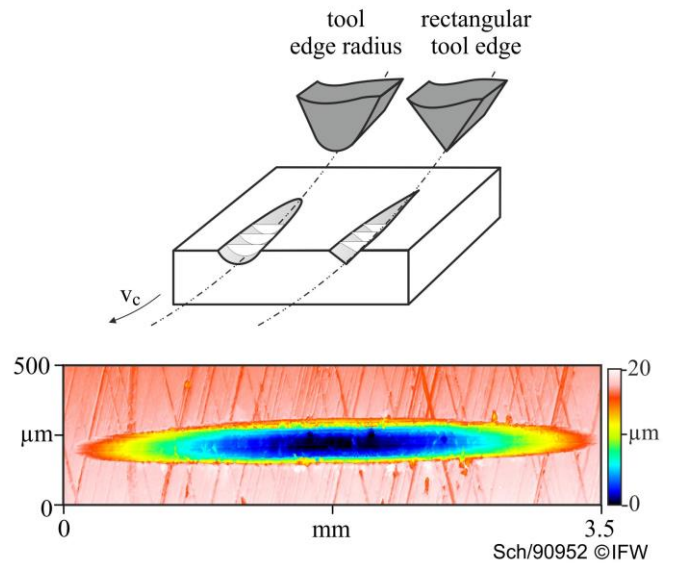
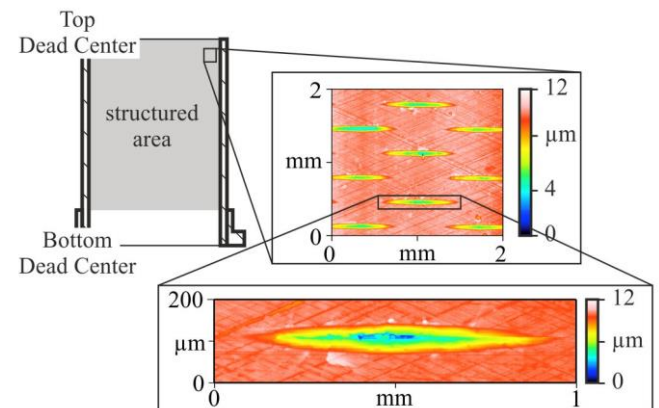

Fig. 2: Example of machined micro dimples with different geometries

The liner needs to be fixed on a hydro clamping mandrel because of the tool’s small engagement depth of 10 μm that needs to be realized evenly throughout the workpiece’s rotation. The cutting process is aligned to the honed area so the liner has to be clamped on the inner surface guaranteeing a concentricity below 20 μm . The remaining error of concentricity results from the clamping errors and workpiece form errors. This remaining error of the concentricity of 20 μm is compensated by the tool which is pressed to the liner’s inner surface with a ball-bearing to guarantee a consistent depth of cut. The tool with its ball-bearing is shown in Fig. 1.



micro dimple layout:	material:	
$a_p = 7 \mu\text{m};$	GJL250	
$s_{ax} = 0.3 \text{ mm};$	cylinder liner:	
$s_{tan} = 1.5 \text{ mm};$	honed, $R_z = 2,5 \mu\text{m}$	
dimple-offset = 50 %	$D = 130 \text{ mm};$	
surface coverage = 16 %	$L = 240 \text{ mm}$	Sch/90943 © IFW

Fig. 3: Layout of cylinder liner and dimple's arrangement

The micro dimple’s arrangement is set by the process variables, which are the feed rate f_{ax} and the rotational ratio λ . The rotational ratio λ defines the number of tool-engagements per workpiece-rotation, which equals the number of micro dimples in circumferential direction and thereby their circumferential distance. The micro dimples’ axial distance is

set by the tool's axial feed rate f_{ax} that equals the axial distance s_{ax} of the micro dimples. The circumferential and axial distance of the micro dimples combined result in the micro dimple's share of the cylinder liner surface S_{mt} . In the current investigations this share is varied between 0 % and 50 % which show the highest benefit, based on previous investigations [2; 3; 4]. The corresponding micro dimple layouts are shown in Fig. 3.

The micro dimple's distance in circumferential direction is set to 1 mm and the axial distance is varied between 0.15 and 2 mm. The circumferential distance yields at a rotational ratio λ of below 300. The corresponding rotational speeds are $n_t = 16 \text{ min}^{-1}$ and $n_{wp} = 4,424 \text{ min}^{-1}$. As they need to be in a defined ratio to each other the maximum rotational speed of the tool, which is $4,500 \text{ min}^{-1}$ limits the process productivity. The current process time for machining 60 mm of micro dimples each on the top and bottom dead center (TDC, BDC) of the cylinder liner sums up to 10 minutes. In order to increase the process productivity, the tool's rotational speed needs to be raised from $4,500 \text{ min}^{-1}$ to over $10,000 \text{ min}^{-1}$, as processes like laser material removal reach higher productivity compared to the machining process [10]. As a result the process's environment needs to be adapted for high productivity machining of micro dimples. This involves higher rotational speeds in the cutting process. For machining micro dimples in cylinder liners an external tool-spindle with tool rotational speed of up to $16,000 \text{ min}^{-1}$ will be integrated into the lathe.

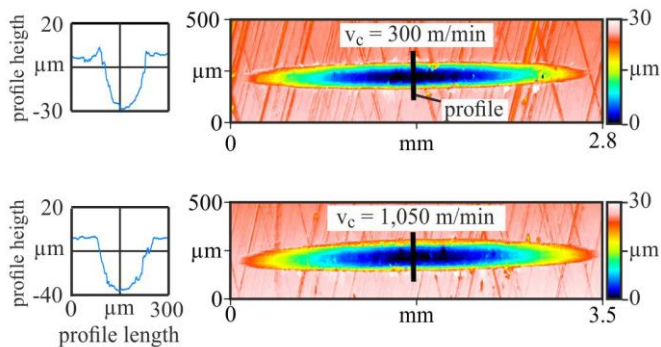

tool:
cermeted carbide
 $\phi = 80^\circ$
 $r_e = 100 \mu\text{m}; r_\beta = 5 \mu\text{m}$
 $\alpha = 7^\circ; \gamma = 13^\circ$

workpiece:
coplanarly ground block
material: GJL250
cutting speed:
 $v_c = 300; 1,500 \text{ m/min}$

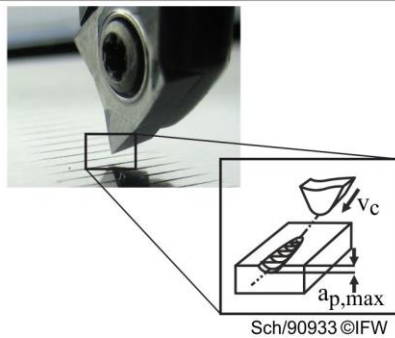

Fig. 4: Micro dimples machined at different cutting speed

The significant increase in the tool's rotational speed leads to highly elevated cutting speeds of over $1,200 \text{ m/min}$. So far, this has not been scientifically investigated for interrupted cuts and small engagement depths. At this cutting speed the material removal behaviour at small single tool engagements is not known today [11]. Consequently analogy tests are conducted in order to investigate the material removal behaviour while

cutting micro dimples at high cutting speeds of up to $v_c = 1,050 \text{ m/min}$.

These are carried out using a single-toothed fly-cutting tool on a plane EN-GJL-250 cast iron workpiece. The tests are conducted on a DMG DMU125 milling center. This milling center allows to generate dimples on plain surfaces at high cutting speed. Fig. 4 shows surface measurements of micro dimple cut at cutting speeds of 300 m/min and $1,050 \text{ m/min}$.

The surface measurements show that micro dimples can be machined at cutting speeds above $1,200 \text{ m/min}$ without quality losses. The micro dimples' quality, i.e. the geometry, is not impaired by higher cutting speeds. Besides the micro dimples' geometry the amount of burr, that is generated at the dimples' edge is a factor that is considered. Fig. 4 shows that the high speed process gives the potential to better dimple shapes than the lower speed. For the cutting speed $v_c = 300 \text{ m/min}$ a small amount of burr occurs with a height of 5 to $10 \mu\text{m}$, as it is shown in Fig. 4. The different quantities of burr result from relatively high amounts of elastic material deformation and low process temperatures [11; 12]. With the increased cutting speed nearly no burr is produced. At higher cutting speed the workpiece material's deformation rates rise, leading to decreased elastic deformation and generation of segmented chips [13; 14]. Due to the orthogonal chip flow less material is accumulated on the dimple edge and less burr is generated.

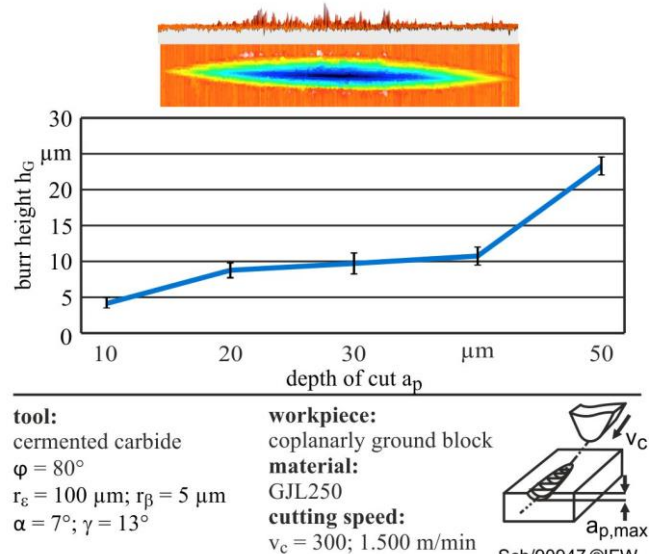

Fig. 5: Amount of generated burr at the micro dimple's edge

These results indicate a good machinability of cast iron for cutting micro dimples at high cutting speeds [15; 16].

Besides the cutting speed v_c the depth of cut a_p is an important variable in machining micro dimples. The micro dimples' depth varies from $7 \mu\text{m}$ to up to $50 \mu\text{m}$. As the used cutting insert has got an edge radius of $100 \mu\text{m}$, the angle between tool and workpiece at the micro dimple's edge changes noticeably. This has got an effect on the amount of burr that is generated at the micro dimple's edge, as Fig. 5 shows. The next step will be the investigation of the tool's dynamic behaviour at high rotational speeds.

3. Measured Friction Forces

The cylinder liners provided with micro dimples are tested on a Floating-Liner test bench in order to evaluate their effect on the friction behaviour [4]. The Floating-Liner system enables to analyze the crank angle resolved piston group friction under fired conditions up to rotational speeds of 1,300 rpm and pressure of 15.5 IMEP. The crank angle resolution is necessary to investigate the different alignment of the dimple distribution.

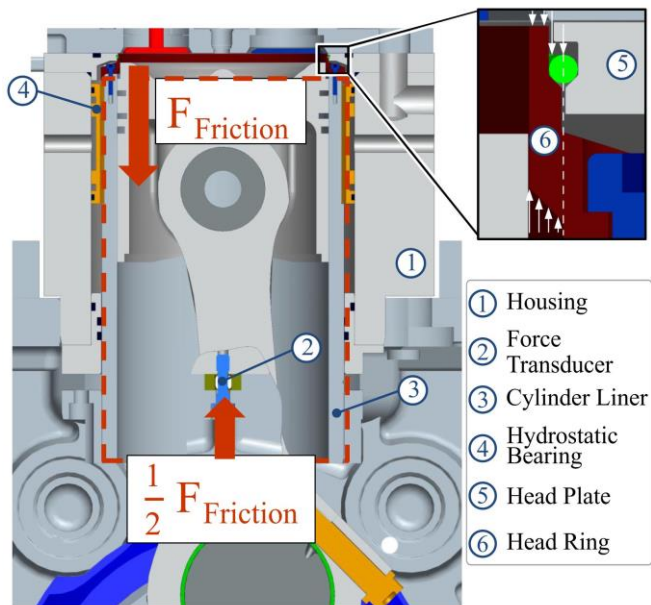

Fig. 6: Floating-Liner system [4]

The liner is movably mounted in stroke direction and based on two electric force transducers (see Fig. 6). The test bench is based on a one cylinder diesel research engine with special designed cylinder housing and a complex sealing gasket. It is fully conditioned to ensure precise operation.

Next, Floating-Liner measurement results will be discussed. The Floating-Liner allows the measurement of friction forces between cylinder liner and piston group. These are used to give evidence about the tribological behaviour in the contact area in engine operation. The friction force measurement is crank angle resolved. This allows the friction forces to be analyzed depending on the piston's position in the cylinder liner. 0° is the TDC, -180° and 180° equals the BDC. Corresponding to the liner's position the relative velocity between liner and piston oscillates from zero at the top and bottom dead center to an maximum which prevails centrally between these dead centers.

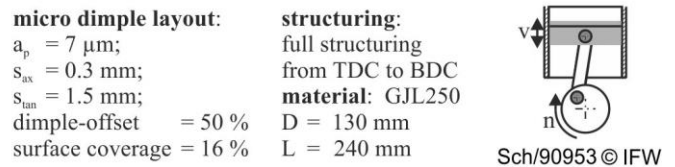
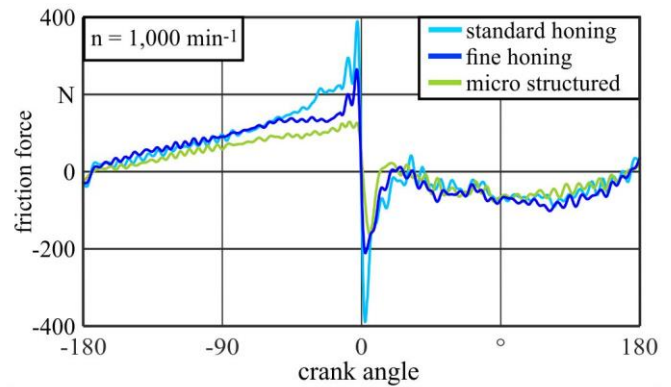

Fig. 7: Friction force of three different cylinder liners [4]

Fig. 7 shows the friction forces of two cylinder liners with different honing roughness. The two levels of honing roughness are a standard honing with an average surface roughness of $R_z = 5 \mu\text{m}$ and a fine honing with $R_z = 2.5 \mu\text{m}$. Additionally the friction forces of a honed cylinder liner with machined micro dimples is investigated. The micro dimples are machined to a honed cylinder liner with $R_z = 2.5 \mu\text{m}$. The friction forces are plotted over half an engine revolution at 1,000 rpm without compression. As it can be taken from the measurements, friction behaviour changes differently depending on the piston's position in the liner. However, the the micro structured liner shows noticeably smaller friction forces, especially near the top dead center at 0° crank angle. This gets most clearly when looking at the force change at the top dead center. In the fine honed liner this sums up to 800 N, whereas the fine honed and micro structured liner only shows a friction skip of 380 N. However, at the bottom dead center (-180° ; 180°) the micro dimples show no benefit. This may be caused by the uniform arrangement of the micro dimples along the cylinder liner in stroke direction. As the conditions (pressure, temperature, oil-volume) change rapidly from TDC to BDC, the area share of the micro dimples needs to be varied in order to guarantee an optimum lubricant film thickness for each area. This leads to the challenge of defining a micro dimple layout, which is beneficial on all piston positions in the liner. The conclusion drawn from the present results is that not only the micro dimple's layout (fully structured vs. only TDC and BDC) should vary in stroke direction, but also that the micro dimples area share must be varied.

4. Conclusion

Micro dimples improve the tribological behaviour of lubricated tribological systems by raising the lubricant supply in the contact area. It was shown that micro dimples can be machined on the inner surface of finish-honed cylinder liners made of GJL-250. The presented machining process allows to generate micro dimples without follow-up finishing processes in the process chain. However, the machining process needs

further development in order to raise its productivity. Another important issue for the future is the machinability of other, hard-to-cut liner-materials or thermally sprayed coatings.

Tests on a Floating-Liner measurement system show that the micro dimples can reduce the friction between liner and piston rings. However, further detailed investigation is required concerning the specific effects of the micro dimples because their advantageous or disadvantageous effect clearly depends on the micro dimple's arrangement in stroke direction. This will result in micro dimple layouts with changing area shares in stroke direction that come to a maximum around the top dead center and the bottom dead center.

Acknowledgement

The presented investigations were undertaken with support of the German Research Foundation (DFG). The authors would like to thank the DFG for its financial support of the project "Tribologisch maßgeschneiderte Zylinderlaufbuchse durch spanend gefertigte Mikrostrukturen". Within this project the cylinder liners were provided by MTU Friedrichshafen GmbH and the Floating-Liner Tests were conducted at the Institute for Technical Combustion (ITV) at Leibniz Universität Hannover. The authors would like to thank the project partners for the good cooperation in this project.

References

- [1] Welzel, F.: Tribologische Optimierung von Zylinderlaufflächen in Verbrennungsmotoren aus fertigungstechnischer Sicht. Dr.-Ing. Dissertation, Universität Magdeburg, 2014.
- [2] Denkena, B., Köhler, J., Kaestner, J., Götsching, T., Dinkelacker, F.; Ulmer, H.: Efficient Machining of Micro dimples for Friction Reduction, ASME Journal of Micro- and Nanomanufacturing, Vol. 1 (2013).
- [3] Kästner, J.: Methode zur spanenden Herstellung reibungsminimierender Mikroschmiertaschen. Dr.-Ing. Dissertation, Universität Hannover, 2014.
- [4] Pasligh H., Oehlert K., Dinkelacker F., Ulmer H.: Crank angle resolved floating-liner friction measurements on microstructured cylinder liner surfaces. In: Bargende M., Reuss HC., Wiedemann J. (Hrsg.) 16. Internationales Stuttgarter Symposium. Proceedings. Springer, Wiesbaden, pp. 133-145, 2016.
- [5] Manzat, A.; Gadow, R.: Investigation on the tribological behavior of thermally sprayed cylinder liner coatings. 14. Internationales Stuttgarter Symposium. Proceedings. Springer, Wiesbaden, pp. 477-492, 2014.
- [6] Chen, C.-Y.; Chung, C.-J.; Wu, B.-H.; Li, W.-L.: Microstructure and lubricating property of ultra-fast laser pulse texture silicon carbide seals. Applied Physics A, 107; pp. 345-350, 2012.
- [7] Flores, G.; Wiens, A.; Waiblinger, M.: Machining and Characterization of Functional Surfaces of Thermal-Coated Cylinder Bores. Coating Technology for Vehicle Applications, pp. 149-161, Springer Verlag, 2015.
- [8] Graham, E.; Park, C. I.; Park, S. S.: Force modeling and application of inclined ball end milling of micro-dimpled surfaces. Int. Journal of Advanced Manufacturing Technology, 70, pp. 689-700, 2014.
- [9] Etsion, I; Sher, E: Improving fuel efficiency with laser surface textured piston rings, Tribol.Int.42 (4), pp. 542–547, 2009.
- [10] Etsion, I: State of the Art in Laser Texturing, Journal of Tribology, 127 (1), (1), pp. 248-253, 2005.
- [11] Neugebauer, R.; Drossel, W.; Wertheim, R.; Hochmuth, C.; Dix, M.: Resource and Energy Efficiency in Machining Using High Performance and Hybrid Processes. 5th CIRP Conference on High Performance Cutting 2012, pp. 3-16, 2012.
- [12] Klocke, F.: Manufacturing Processes I. Springer-Verlag, 2011.
- [13] Jackson, M.: Micro and Nanomanufacturing. Springer-Verlag, 2007.
- [14] Gentili, E.; Tabaglio, L.; Aggogeri, F.: Review on Micromachining Techniques. Advanced Manufacturing Systems and Technology 486, 2005.
- [15] Berns, H.; Theisen, W.: Ferrous Materials, Springer-Verlag, 2008.
- [16] Ducobu, F.; Filippi, E.; Riviere-Lorphevre, E.: Chip Formation and Minimum Chip Thickness in Micro-milling.