

## Energy efficient machine tools

Berend Denkena (1)<sup>a</sup>, Eberhard Abele (1)<sup>b</sup>, Christian Brecher (1)<sup>c</sup>, Marc-André Ditttrich<sup>a</sup>, Sami Kara (1)<sup>d</sup>, Masahiko Mori (1)<sup>e</sup>

<sup>a</sup> Institute of Production Engineering and Machine Tools (IFW), Leibniz University Hannover, Hannover, Germany

<sup>b</sup> Institute of Production Management, Technology and Machine Tools (PTW), TU Darmstadt, Darmstadt, Germany

<sup>c</sup> Laboratory for Machine Tools and Production Engineering (WZL) of RWTH Aachen University, Aachen, Germany

<sup>d</sup> Sustainability in Manufacturing & Life Cycle Engineering Research Group, School of Mechanical and Manufacturing Engineering, University of New South Wales, Sydney, Australia

<sup>e</sup> DMG Mori Co. Ltd., Tokyo, Japan

### ARTICLE INFO

#### Article history:

Available online 31 July 2020

#### Keywords:

Energy efficiency  
Machine tool  
Metal cutting

### ABSTRACT

The growing global energy demand from industry results in significant ecological and economical costs. Aiming to decrease the impact of machining operations, an increasing number of research activities and publications regarding energy efficient machine tools and machining processes can be found in the literature. This keynote paper provides an overview of current machine- and process-related measures to improve the energy efficiency of metal cutting machine tools. Based on an analysis of the energy requirements of machine tool components, design measures to reduce the energy demand of main and support units are introduced. Next, methods for an energy efficient operation of machine tools are reviewed. Furthermore, latest developments and already available energy efficiency options in the machine tool industry are discussed. The paper concludes with recommendations and future research questions for more energy efficient machine tools.

© 2021 The Authors. Published by Elsevier Ltd on behalf of CIRP. This is an open access article under the CC BY license (<http://creativecommons.org/licenses/by/4.0/>)

## 1. Introduction

Worldwide electricity generation mainly relies on the use of fossil fuels. As a result, it accounts for about a quarter of the global greenhouse gas emissions. According to the Intergovernmental Panel on Climate Change (IPCC), CO<sub>2</sub> emissions have to be decreased by approximately 25% until 2030 and need to reach net zero in 2070 to achieve the 2 °C climate goal [108]. This goal, along with the threatening scarcity of non-renewable resources for energy generation, is in dispute with a seemingly insatiable hunger for energy and low energy prices. During the last 30 years, the worldwide energy demand has nearly doubled due to globalisation, a growing population and an expanding industry [102,203] (Fig. 1).

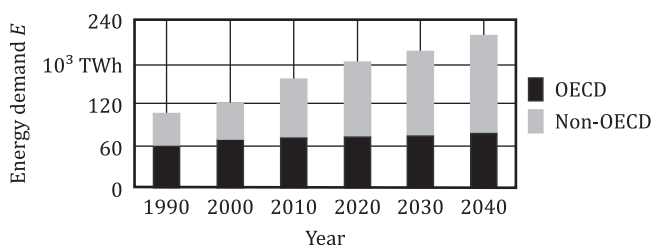

**Fig. 1.** Development of the global energy demand based on [203], including all energy forms generated from petroleum and other liquids, natural gas, coal, as well as nuclear or renewable sources.

E-mail address: [denkena@ifw.uni-hannover.de](mailto:denkena@ifw.uni-hannover.de) (B. Denkena).

<https://doi.org/10.1016/j.cirp.2020.05.008>

0007-8506/© 2021 The Authors. Published by Elsevier Ltd on behalf of CIRP. This is an open access article under the CC BY license (<http://creativecommons.org/licenses/by/4.0/>)

An increasing burden on the ecosystem in the form of carbon emissions, the destruction of natural habitats for raw material extraction and global warming are only three of the repercussions of the required energy supply [145]. These effects in combination with an increasing ecological awareness represent major challenges for the industry [46], which accounted for a 38% share of the global electrical energy demand in 2018 [103]. Based on various studies, a share of 5 to 10% of this 38% is estimated to be the respective energy demand of machine tools [183,204]. Furthermore, the German machine tool market distribution indicates that 70 to 80% of these machine tools are cutting machine tools [208]. In summary, cutting machine tools account for 1 to 3% or 200 to 700 TWh of the global electrical energy demand, trends ascending. On average, this corresponds to Germany's total electrical energy demand in 2016 [205]. In addition to this, machine tools are often characterised by large energy losses. For this reason and because of a fairly easy influence of their energy demand, machine tools are a sensible starting point for energy efficiency measures in the manufacturing industry, even though they inherit long amortisation periods and high implementing costs.

As indicated by an exemplary study on the production systems used by an automobile manufacturer, the average power range of cutting machine tools has increased drastically in the last decades (Fig. 2) [225]. This development is caused by a growing number of installed electronic components since the 1970s to meet the need for high-performance machine tools. Due to ever-increasing productivity and accuracy requirements, further growth is likely [123,225]. However, it should not be neglected that an evaluation solely based on the power rating is not appropriate. Rather, the actual energy

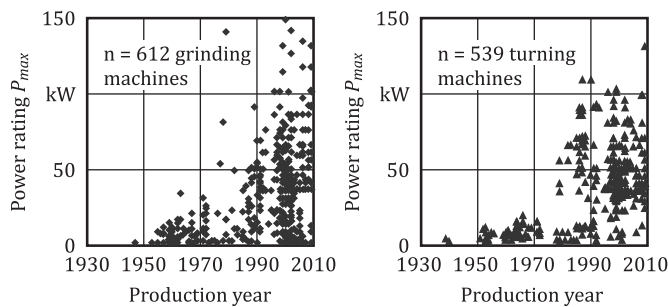

Fig. 2. Power rating of machine tools based on [225].

efficiency must be evaluated, since an increased power demand paired with a high cutting performance does not necessarily lead to efficiency losses. For this purpose, an evaluation basis is required, which is set out in the beginning of this paper. Based on this evaluation approach, measures to increase the energy efficiency of cutting machine tools during their life span are presented. The measures are structured according to two approaches, namely, optimising the main and support units of the machine tool concerning their energy requirements, and energy saving through operational efficiency measures, e.g. by adjusting process parameters. Based on an energy demand breakdown of typical metal cutting machine tools, critical components with a high energy savings potential are identified. These units are examined in more detail, followed by an in-depth description and evaluation of specific measures to increase their energy efficiency. The second part of the paper describes approaches and process strategies for energy efficient operation of machine tools. Since excellent reviews about the manufacturing system level, such as the energy efficient production scheduling, already exist, these aspects are excluded from this paper. To illustrate the practical significance of energy efficiency in industry, an overview of energy efficiency measures that have already been implemented by machine tool manufacturers follows. In this context, different case studies are presented to determine the energy savings potential for practical production scenarios. The paper concludes with a summary of the main findings and gives an outlook for future research.

## 2. Definitions

The evaluation of energy efficiency measures depends strongly on the drawn system boundaries and the definition of energy efficiency itself. Therefore, system boundaries are defined and a calculation rule for energy efficiency of machine tools is proposed in the following chapter.

### 2.1. System boundaries

The measures described here relate to cutting machine tools and their main and support units as well as their operation. Upstream and downstream processes such as raw material extraction or recycling are neglected. Further, only measures that directly influence the operation are considered. For this reason, mechanical design measures such as lightweight construction of machine tool components are excluded from the scope of the paper.

As can be seen in Fig. 3, the main units include the machine frame as well as rotary and feed axes. Machine axes, in turn, consist of drives, including motors and inverters, guideways and bearings. Apart from the main spindle, the drive components usually actuate rotary tables, slides or other auxiliary systems, e.g. for tool or pallet changes. Additionally, the main components include the performance and information controls as part of the machine control system [200]. Support units usually include various auxiliary systems to supply all sorts of media, i.e. coolant, cutting fluid, lubricant, mineral oil or compressed air, to the machine tool. Accordingly, typical auxiliary components are the machine cooling, the cutting fluid supply, as well as hydraulic and pneumatic systems. Moreover, support units further cover subsystems for the recirculation and preparation of the introduced auxiliary

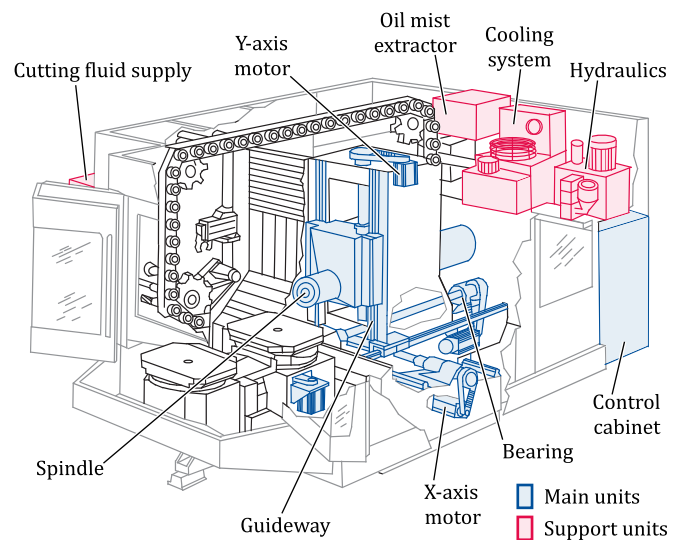

Fig. 3. Typical structure of a cutting machine tool based on [59,77,200].

materials, namely retraction pumps, oil mist extraction systems, chip conveyors, filter systems and heat exchangers.

Because of the large variety of machine tool types, different specifications must be taken into account depending on the desired machining process, e.g. milling, drilling, turning or grinding, work-piece spectrum, e.g. size or material, and machining operation. Nonetheless, the individual main and support units are not fundamentally different from each other even for distinct machine tool configurations. Therefore, the typical structure of a machine tool from Fig. 3 is applicable in most cases and consequently chosen for this paper.

### 2.2. Energy efficiency

To improve the energy efficiency of a machine tool, the term energy efficiency has to be defined first. In common linguistic usage, efficiency is defined as the relationship between output and input [65]. Analogously, several authors have defined energy efficiency and energy efficiency indicators [46,130,135,188]. The ISO 14955 standard for the environmental evaluation of machine tools defines energy efficiency as the “ratio or other quantitative relationship between an output of performance, service, goods or energy, and an input of energy” [109]. This statement is in line with Patterson’s definition from 1996, which fundamentally describes energy efficiency for the industrial sector as the relationship between useful process output and energy input into a process [163].

On the component level, various definitions for energy efficiency of individual systems are already established, which again deviate from the suggested energy efficiency indicator for the entire machine tool. For example, the energy efficiency of a motor is the ratio of mechanical output power to electrical power input, the energy efficiency indicator for a cooling unit is defined as the ratio of provided cooling capacity to electrical power input. On the system level, the choice of reference and machining operation has a decisive impact on the resulting energy efficiency measures. A consideration of additional operating states of the machine tool, such as start up or idle mode, introduces additional layers of complexity in determining the energy efficiency. Hence, a well-defined frame of reference is crucial to achieve an objective assessment of a machine tool’s energy efficiency and to ensure comparability between different machine tools. Therefore, an assessment standard is developed in the following. Putting Patterson’s definition of energy efficiency into the context of this paper, i.e. applying the definition to metal cutting machine tools, the energy input into a process corresponds to the electrical energy drawn by the machine tool over the course of the machining operation. The electrical energy in turn is the product of the operation time and the electrical power demand. Thus, the total power demand  $P_{Total}$  is chosen as input for energy efficiency calculation. The power

demand for the cutting movement itself is selected as useful output, which is represented by the spindle power demand  $P_{Spindle}$ . In summary, this results in the following term for the assessment of the energy efficiency of machine tools:

$$\eta_{MT} = \frac{P_{Spindle}}{P_{Total}} \quad (1)$$

As indicated by equation (1), an increase in energy efficiency is achieved by maximising the cutting performance while at the same time minimising the overall power demand of the machine tool. In practice, this means utilising the work spindle's full power range and selecting process parameters in such a way that the removed chip volume is maximised. Moreover, the base load and power requirements of the support units must be reduced. In this regard, a number of measures has been developed by several authors and is presented and evaluated within the framework of this paper.

At this point, it must be emphasised that optimal operating conditions are assumed in the evaluation. Primarily, this means a high spindle utilisation. However, to meet quality requirements, machine and process cooling are usually necessary due to inevitable thermal effects, which in turn reduce efficiency. Depending on the application, an optimum operating point must therefore be identified. Implemented energy efficiency measures provide only minor improvements, when the machine tool is operated inefficiently.

### 3. Energy demand of machine tools

In one of the first studies on energy efficiency of machining, De Filippi et al. [81] found that the energy demand of the machining process is significantly higher than the required energy for the chip formation. According to Zhou et al. [227], the variable part accounts for 20 to 30% of the total energy requirement in machining. These findings are supported by other studies, e.g. [22] or [89]. In addition to the need for electrical energy, other media such as compressed air, cold water or cooling lubricant are often required. The exhaust air as well as other introduced media must be extracted from the workspace to be treated and eventually stored for resupply. Depending on the external boundary conditions, the supply with media is centralised or decentralised in a plant [131]. In the case of a decentralised supply, all support units are within the system boundaries of the machine tool. Typically, electrical energy and compressed air are the most relevant energy inputs [109].

In this section, an overview of factors influencing the energy demand of machine tools is given. Subsequently, an energy breakdown of machine tool components is presented based on the reviewed literature. Finally, an evaluation of the energy saving potentials is presented.

#### 3.1. Factors influencing the energy demand

A number of factors influence the energy demand of machine tools, which are summarised in Fig. 4. The fixed energy demand, which includes the energy required for idle running of the machine,

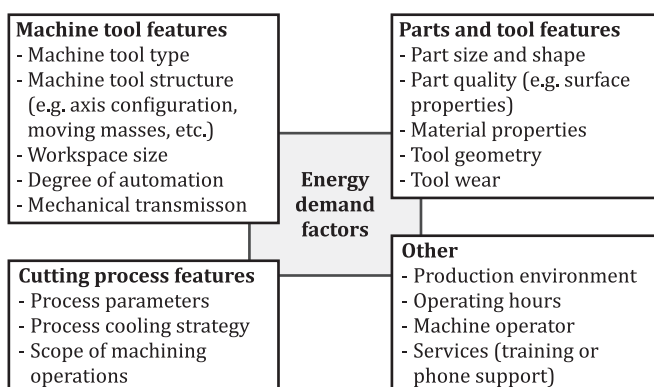

Fig. 4. Factors of energy demand, adapted from [227].

is determined by the machine tool's features, e.g. size, arrangement of axes, moving masses and degree of automation. The variable part of the overall energy demand, which encompasses all energy demands that are required for the actual processing of the material, consequently depends on part characteristics, tool features, cutting parameters and process cooling strategy [227]. It must be noted that there are interactions and coupling effects between these factors and that they can have an influence on both fixed and variable energy demand at the same time. For example, Neugebauer et al. showed that additional and larger support units are required with increased workspace size, which ultimately leads to a higher overall energy demand [157]. Consequently, the choice of the machine tool significantly affects the energy demand.

However, there are other factors which have a (more or less pronounced) impact on the energy requirements of machine tools. For instance, Bittencourt proposes an alternative classification of influencing factors into six main categories: machine tool, measurement, workpiece material, method of production and control, production environment and machine operator [30]. In this context, Mert et al. also discussed whether the operator can positively influence the energy efficiency of machine tools through appropriate services, e.g. training or telephone support [147]. In addition, the operating time of the machine tool naturally influences the energy demand [26]. Based on shift models, runtimes and load factors, the machine tool remains in specific energetic states for different periods of time. Depending on whether small or large series production is considered, there is also a different distribution of the machine states and consequently times in different energy states. In both cases, however, standby concepts can be used for longer production pauses [36].

Varying process parameters influence not only the energy requirement but also the tool wear and quality of the workpiece. Here, an optimisation of the process parameters with regard to an energy optimal solution does not always meet the demand for minimum costs [172]. Furthermore, the choice of the cooling strategy has a significant influence on the energy requirement, but can also influence the workpiece quality, so that it is difficult to make a clear statement regarding the advantages of a particular strategy in terms of energy efficiency [97,122]. The optimisation of process parameters in machining processes has been investigated many times in the past and particularly depends on the target variable to be optimised, as shown in Chapter 6.

#### 3.2. Assessment of the energy demand

In most cases, the true energy demand of a machine tool depends not only on its specification, but also on the considered application, see Fig. 4. The power rating of a machine tool consequently offers little information about its actual energy demand in use. Hence, the quantification of the true energy demand of machine tools is indispensable for the identification and implementation of specific energy efficiency measures in the industry, as stated in the ISO 14955-1 standard [109,121].

In principle, a distinction must be made between existing machine tools and those to be designed. For systems that do not yet physically exist, simulative approaches often represent the only option to estimate the true energy demand in use (see Chapter 6). For existing machine tools, power measurements are a more reliable method to determine the actual energy requirements. Although, it is possible to apply simulation-based approaches for existing machines to reduce the measuring effort.

The metrological determination of the energy demand requires specified system boundaries. It may also be necessary to consider other media that result in relevant energy flows, such as compressed air, coolant or cutting fluid [109]. Before the actual energy measurements, time studies are required to obtain typical usage scenarios of machines under consideration and to identify relevant energy states to be measured [62]. Operating hours, for example, may be determined by reading of spindle hours, machine data acquisition or manufacturing execution systems [26]. The ISO 14955-2 standard provides a set of rules for the correct measurement of energy and media requirements [110]. In addition to the already existing ISO

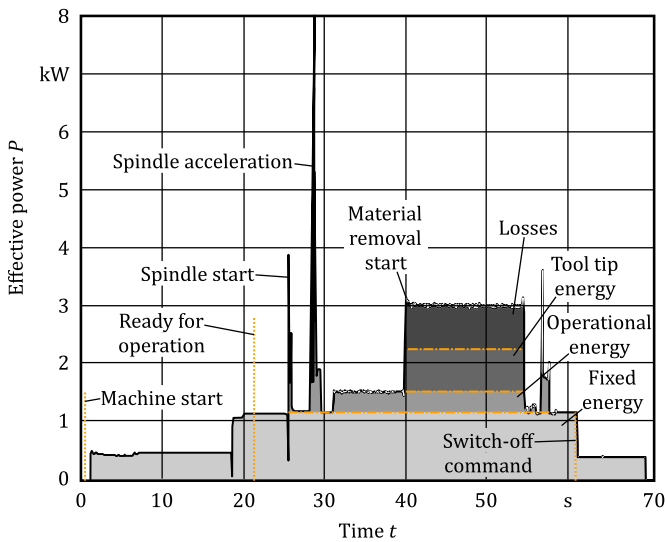

Fig. 5. Power profile of a turning process based on [136,137].

standards, the ISO 14955-3 is currently under development [111]. It aims to assess relevant energetic machine states and the transitions between them based on individual reference scenarios. Based on energy studies, the measured power profiles (see Fig. 5) can be used to determine the actual energy demand and derive suitable energy efficiency measures based on the identified energy intensive components and processes [62,85].

Nevertheless, there is normally a trade-off between the need for detailed data and the associated costs and time to collect it when measuring the energy demand of any real system [7,199]. In addition to measurements and simulations, estimation methods can be applied to determine the expected energy demand. Beck et al., for instance, provide a method to quickly and cost-effectively identify energy efficiency measures for machine tools using technical documentations, historical and future production data as well as expert knowledge without having to perform measurements [26].

### 3.3. Energy breakdown of machine tool components

Machine tools consist of both main units and support units as shown in Chapter 2. In addition to the work spindle, main units also include feed drives, bearings and guideways. Usually, the work spindle has the most significant influence on the energy demand [10]. Support units run permanently to maintain desired machine and process conditions, i.e. machine temperature and cutting conditions with regard to cooling and lubrication in particular. Other secondary functions include chip removal, oil mist extraction, fluid preparation and distribution as well as providing hydraulic pressure and compressed air. Due to today's accuracy requirements, it is not surprising that support units have a decisive influence on the overall energy demand of machine tools [38, 96,131,226].

There are several ways to classify the energy demand of machine tools. Zhou et al., for example, distinguish five different categories for classification, with each category containing further subcategories that allow for the complete allocation of a machine tool's total energy demand [227]. In addition to the distinction based on the operation status, energy attribute and main energy consumption components, a distinction is also made between functional movement and composition system. The functional movement category considers the various motion sequences of a machine tool, e.g. positioning or rotation of the cutting tool and the workpiece (without tool engagement), actual cutting kinematics, or auxiliary movements for tool and workpiece handling. The composition system category refers to the individual components and subassemblies of the machine tool, e.g. main transmission, feed or auxiliary systems.

The energy attribute is regularly subdivided into fixed and variable energy demand. However, machine tools regularly feature

different energy states that exceed the simplified subdivision into fixed and variable energy demand. Fig. 5 shows an exemplary power profile of a machine tool in a turning process. The active power was measured at the main switch from the switch-on time until the complete shutdown. The measurement results illustrate a particularly high base load, i.e. the fixed energy demand required to ensure the operational readiness of the machine, which is typical for modern machine tools. Additional energy (labelled operational energy) is required to move the feed axes and rotate the main spindle as in the case of an air cut. Only a rather small proportion of the introduced energy is used for the actual material removal process (tool tip energy). In addition, further losses occur during machining, e.g. in the form of heat as the result of increased friction and ohmic losses. Notably, a certain amount of time passes after the switch-off command until all components are inactive and the power draw of the machine tool drops to zero [136,137]. The fixed and operational energy demand can be determined by power measurements while performing air cuts. The tool tip energy, however, is usually determined by calculations based on the expected cutting forces. The specific energy losses in the machining process can be estimated by subtracting the previously determined energy components from the measured total energy, as demonstrated by Li and Kara [136].

Usually the most relevant states are standby, operational (ready for processing) and working (processing), which are the focus of the following section. In addition, there are also energy transitions such as powering up or warm up, which, however, account for a smaller proportion of the energy demand [109,207]. Nevertheless, the relevant energy states vary depending on numerous factors, and different terminologies are used to describe the same energy state, e.g. processing, working or cutting state for the energy state in which machining takes place [109,207,226].

With regard to the characteristics of the electrical power demand of machine tools, stationary and non-stationary power profiles of the various components are distinguished [131]. The addition of the components' power profiles results in the power profile at the main connection, as shown in Fig. 5. A qualitative representation of different power profiles including exemplary machine tool components is shown in Fig. 6. The oil mist extraction, for example, has a stationary power demand independent of the machine condition and is permanently active in most cases. Other components may also show non-stationary power profiles, e.g. a compressor with a 2-point control. This example shows, that non-stationary behaviour does not necessarily mean a variable energy demand, but can also represent a fixed energy demand. A cutting fluid pump may have different power demand levels at different operating points and the power profile of a spindle clearly shows the acceleration and deceleration processes [131].

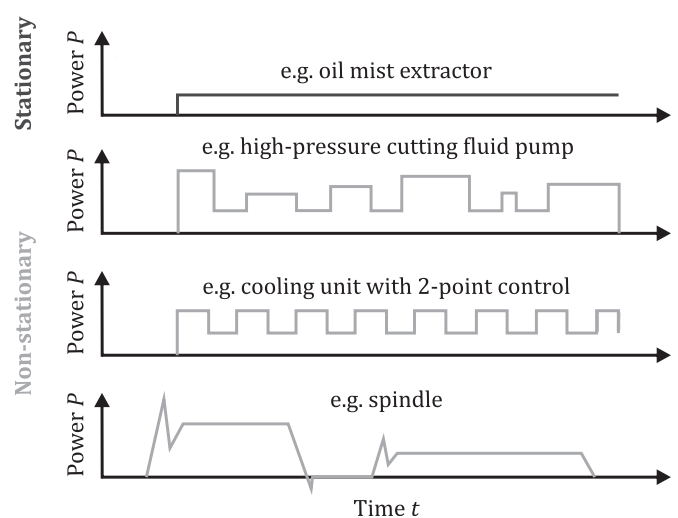

Fig. 6. Qualitative power profiles of different machine tool components based on [131].

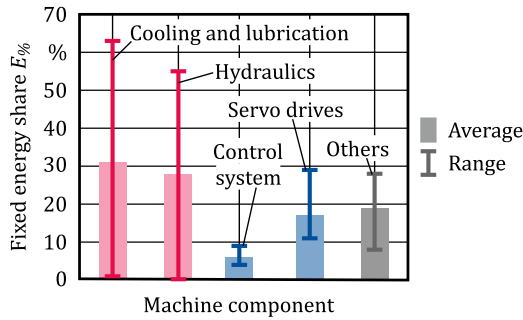

Fig. 7. Average, minimum and maximum fixed energy shares of six reviewed machine tools based on [137].

Fig. 7 shows the share of fixed energy demand of individual components for different machine tools. Two grinding machines, two lathes and two machining centres with different work spindle configuration were examined. The hydraulic, cooling and lubrication systems in particular account for a high proportion of the overall energy demand. In addition, the energy shares of individual components occur in a wide range, which is explained by the individual and highly varying configuration of machine tools in general.

Fig. 8 illustrates an additional example for the power distribution of a vertical lathe. The presented data emphasises the relevance of support units regarding energy requirements as they account for more than 70% of the overall power demand. Furthermore, the figure provides the ratio of usable heat to waste heat, whereby the usable heat is fluid bound and collected in the machine cooling system. The waste heat, on the other hand, is the heat that is emitted to the environment via conduction, convection and radiation. The ratio of usable to waste heat primarily depends on the provided infrastructure for waste heat recovery and utilisation rather than the actual machine tool configuration. For the considered use case, approximately 46% of the heat losses are repurposed for other processes, e.g. through thermal crosslinking with cleaning machines by using a heat-pump, when they are dissipated in a fluid bound manner [100,117,118].

In recent years, several research projects have extensively addressed the energy efficiency of machine tool components and support units in particular [8,32,53,96,126] as well as the simulation of the energy demand [3,4,19,80,210]. Fig. 9 shows the total energy demand as well as the shares of the main and support units for a selection of investigated machine tools.

Based on these investigations, it can be stated that the support units most commonly account for a dominant part of the overall energy demand, although there are variations in the shares of the

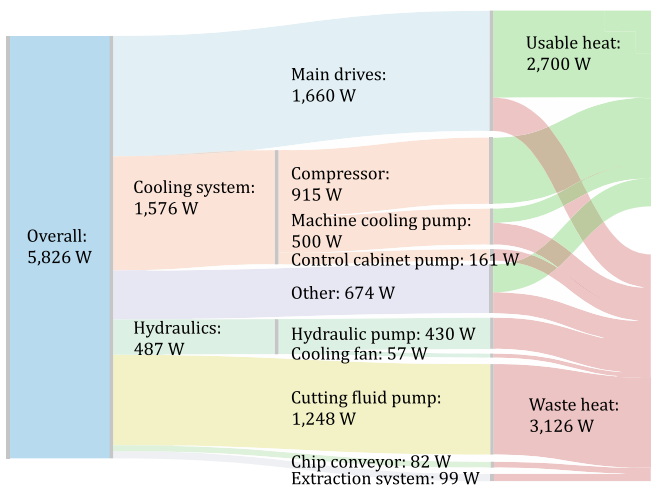

Fig. 8. Average electric power demand of a lathe type EMAG VLC 100 Y in machine mode working based on [118].

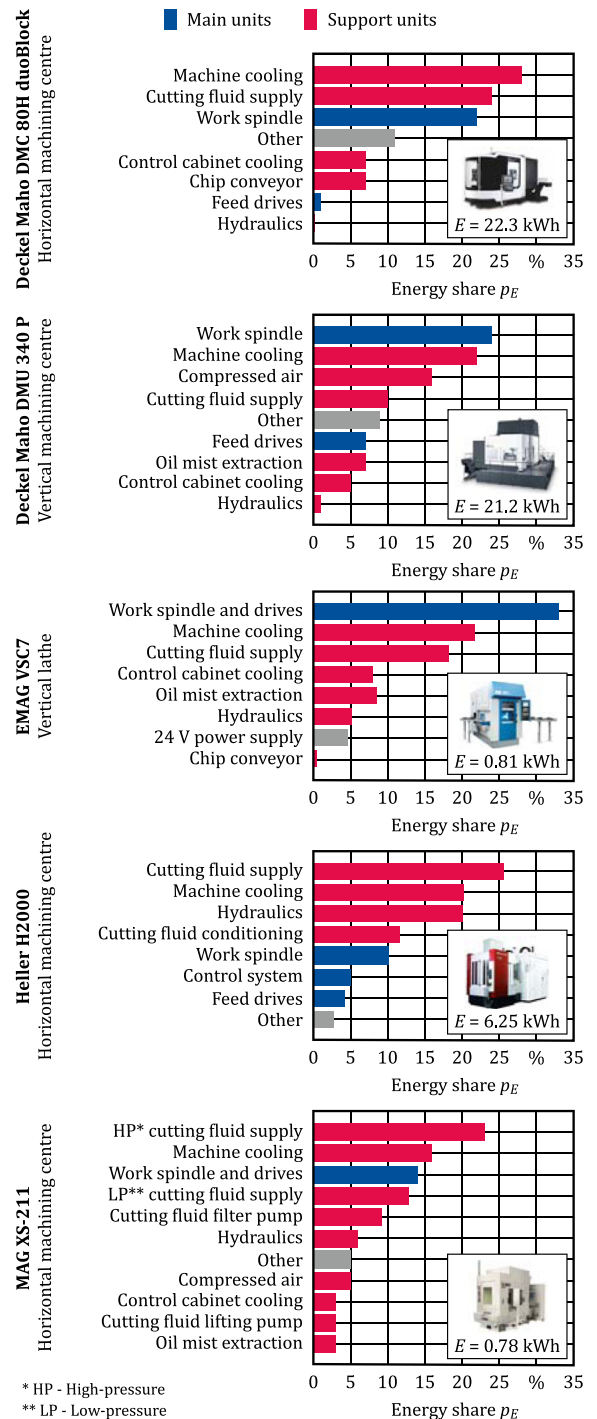

Fig. 9. Share of energy demand of main and support units of five considered machine tools for machining of a reference workpiece based on [4,8,32,53,101].

components. The variations of the overall energy demand and the energy distribution result from the individual configurations of the machine tools selected for the respective application. Even though the main spindle and drives account for more than 30% of the total energy requirement of the vertical lathe EMAG VSC7, the support units are still responsible for the majority of the energy demand. It is shown that machine cooling accounts for the second largest or even the largest share of the required energy for the considered cases. The differently configured cutting fluid systems require another considerable share of the overall energy input. The case of the vertical machining centre Deckel Maho DMU 340 P clearly shows that the compressed air supply can also account for a large part of a machine tool's total energy demand.

### 3.4. Evaluation of energy saving potentials

To evaluate potential energy savings on machine tools, an overview of typically occurring energy losses is necessary. Neugebauer et al. first distinguish between load-independent and load-dependent losses, which have to be analysed at a system level [157]. Subsequently, a further distinction is made between four loss types: electric, damping, friction and flow losses. Minimising these losses is of course beneficial, but offers relatively low energy saving potentials due to the advanced state of development of most machine tool components. Beck et al., on the other hand, distinguish a total of eight types of energy losses, particularly addressing losses due to idle machine states, incorrect component dimensioning and inefficient technology application [27]. According to their approach, all losses are dissipated as waste heat and only a minor proportion of the overall energy input is used for the value adding process.

In addition to the technically inherent losses of individual components, typical causes for energy waste in machine tools are oversizing, idle times and overproduction, e.g. in the form of excessive pressure levels in the cutting fluid system [39,87,157,177,214]. Oversizing of main units and especially auxiliary equipment presents the most common reason for poor energy efficiency. Based on unrealistic estimates of the load cases, machine components are usually oversized to ensure their functionality. Consequently, the design for an excessively overestimated load case leads to inefficient operating points for the main and support units in actual machining processes with significantly lower loads [27]. Hence, optimising the units' design and mode of operation holds a significant potential to increase the overall energy efficiency of machine tools. Here, the key to high energy efficiency is to provide energy and media according to actual process requirements. This solution approach can be also applied to the issue of overproduction. However, the reduction of the machine components' energy requirements must be achieved without compromising the process stability and machining result [137,161,226].

It should also be noted that the efficiency of induction motors increases with the power rating, see Fig. 10. Thus, the efficiency of oversized motors is not inherently worse. However, induction motors have their maximum efficiency at a designated operating point. Hence, the efficiency advantage of larger motors decreases with increasing distance to the designated point of operation [177]. A needs-based dimensioning may also lead to lower investment costs [87]. To increase efficiency beyond the needs-based provision of energy and the use of efficient components, the recovery of unavoidable waste heat can further increase the overall efficiency of components and entire machine tools [117].

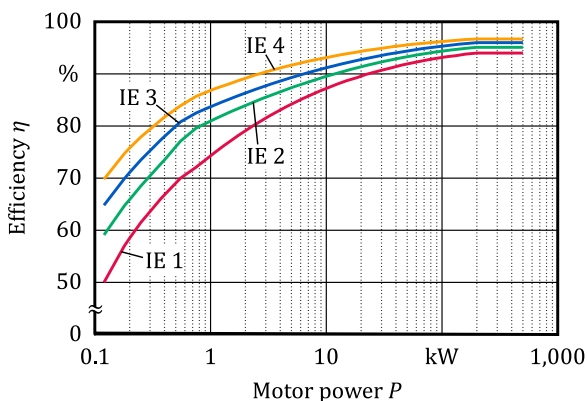

Fig. 10. Efficiency classes for electro-mechanical drives (derived from IEC 60034-30-1:2014 [104]).

### 3.5. Interim conclusion

Most notably, it can be stated that the energy demand of machine tools is significantly higher than the energy required for the actual value-adding chip removal process. The primary reasons for this are losses within the machine tool and the use of auxiliary units for

machine and process conditioning, which do not directly contribute to the value creation. The actual energy requirement and energy distribution of machine tools depend on various factors, e.g. the machine configuration, the type of machining, the process cooling strategy and the operating parameters. Hence, the identification of a machine tool's true energy characteristics as well as the technical and economic evaluation of potential energy efficiency measures regularly requires time-consuming measurements or simulations. Against the background of the subordinate relevance of energy costs, the widespread implementation of energy efficiency measures has not taken place so far.

In principle, energy savings potentials can be attributed to two approaches, namely the technological optimisation of individual components and the energy efficient process design including the demand-oriented supply of media and energy. In the following, the main units relevant for value creation are discussed with regard to their energy efficiency, whereby the work spindle usually has a dominant influence on the energy demand. Subsequently, the peripheral support units are discussed, with cooling and lubrication units as well as hydraulics having a decisive influence on the overall energy requirements and therefore being focused. After presenting optimisation potentials at main and support unit level, Chapter 6 describes the energy efficiency potentials resulting from the interaction of these units during the operation of machine tools.

## 4. Main units

The design of the main components depends directly on the desired process. Generally, main units include the following components: drive systems for feed drives and work spindles, mechanical translation units for indirectly driven systems (e.g. ball screw drives, rack and pinion drives as well as toothed belts and gearboxes), bearings and guideways. Fig. 7 reveals that the energy demand of servo drives may account for one tenth to nearly one third of a machine tool's total energy demand, depending on the process. In the first part of this section, efficiency improvement measures for electrical motors and inverters are reviewed, some of which also apply to motors for auxiliary equipment. The second part focusses on the impact of bearings and guideways on the energy efficiency of machine tools.

### 4.1. Drives and control units

Main electrical drives create linear and rotational movements of tools and workpieces. Therefore, the components are directly dependent on the processing power. For processes with high processing power requirements, the efficiency of main drives has a significant impact on the total energy efficiency of the machine tool. For the general optimisation of the efficiency of motors, including feed drives and main spindle drives, efficiency classes and their test procedures have been defined in the standards IEC 60034-30-1:2014 [104] and IEC 60034-2-1 [105]. These standards prescribe specific efficiency values for the electrical and mechanical power, see Fig. 10, and combine older national standards such as EFF classes and NEMA standards. Based on these standards, several governments, including all members of the European Union, stipulate several minimum efficiency classes for specific applications. For example, the European Commission prescribes the use of at least IE 3 motors for midrange power applications without inverters (0.75 to 375 kW, except pole changing motors, motors for special thermal conditions or motors with more than 8 poles) in the regulation no. 640/2009 [79]. A further increase over the IE 4 class of the efficiency requirements for new motors can lead to a decline of induction motors in machine tool applications due to their limited efficiency [14,84,212]. These motors are often used for work spindle drives and auxiliary systems. Alternatives that are more efficient are synchronous reluctance motors or synchronous motors. Technical requirements and energy models for the design of drive systems containing motors and inverters or alternative systems, such as soft starters, are defined in the standards EN 50598 [60] and EN 61800-9-1 VDE 0160-109-1:2018-1 [61]. In

contrast to the previous standards, the main idea is to also consider mutual effects between motors and inverters such as time harmonics in drive systems. In this context, possible generic improvements can be separated into software- and hardware-based changes.

Software-based changes mainly consist of changes in the motor control. By minimising the pulse width modulation (PWM) frequency and, thus, reducing the charging and discharging effects in the semiconductor switches, the power losses can be decreased. Because of the high bandwidth requirements of motor controls in machine tools, a possible approach is to adapt the PWM frequency to the expected load [146,220]. Another approach is to reduce the main flux of induction motors dependent on the expected load [11,32,124]. Other approaches include changing the PWM pattern [128] or finding a trade-off between control bandwidth, permissible vibrations and energy efficiency [109]. Consideration of reluctance effects of synchronous motors with two inductances is the state of the art. Therefore, further research needs to be carried out for a more efficient torque ripple control by use of non-linear control techniques [50].

Hardware-based changes for motors contain approaches to handle the trade-off between reduced torque ripple for large dynamic systems, cost of production and small power losses. Concentrated windings often have a lower copper resistance than distributed windings, but they also cause a higher cogging torque [29]. A similar effect can also be observed in skewing of the rotor and stator [49]. The main reason is the high cost for rare earth permanent magnets that reduces the number of used synchronous motors in production machines, hence resulting in lower energy efficiency [129]. To decrease inverter losses, research focuses on improving circuits to reduce switching losses, such as resonant circuits [223], as well as on the optimisation of semiconductor switches. By filtering the PWM excitation as well as time harmonics, iron losses can be reduced in the motor [196]. An alternative concept to filters is to use multi-level converters [190,192].

Another approach to increase the energy efficiency of electro-mechanical drives is the use of a recuperation system. Recovery systems for braking energy are state of the art for larger drive systems [64]. But for smaller drives (typically low kilowatt range), the braking energy is usually dissipated through braking resistances, as these are cheaper to produce. Different suppliers also offer the possibility to increase the capacity of the capacitors of the DC intermediate circuit and have a large tolerance of the DC voltage. This method reduces the usage of braking resistances [179]. To reduce the space for control cabinets, several companies offer decentral inverters, which are directly connected to the motor. Since it needs its own DC intermediate circuit including a rectifier, it can decrease the energy efficiency compared to a multi-axes inverter system.

#### 4.1.1. Main spindle drives

The work spindles drive tools as well as workpieces and significantly influence the added value production due to their proximity to the cutting process. Typical design variants of main spindle drives are integrated motor spindles (motor on tool clamp), indirectly driven spindles (via belt drive or gearbox between motor and spindle) or hybrid spindles (a combination of both). Integrated motor spindles are mostly used due to their high stiffness. In comparison to indirectly driven spindles, they have no gears or belt drives, which creates a high demand for cooling capacity for high torque applications. In particular, the axial displacement due to thermal effects has to be limited to minimise tolerance deviations on the workpiece. An indirectly driven spindle is thermally better separated from the process; however, the limited mechanical efficiency of the gearbox reduces the spindle's overall efficiency even further [181]. Statistics in [10] reveal that most spindle motors are induction motors followed by synchronous motors. As described above, the high requirements of the energy efficiency classes will lead to the replacement of induction motors by more efficient motors in the long run. A study is done in [9,193] to test synchronous reluctance motors with and without permanent magnets to find alternatives to the more expensive synchronous motor. Both fulfil the requirements of IE 4, but both also have a higher torque ripple and require more complex inverter systems. The

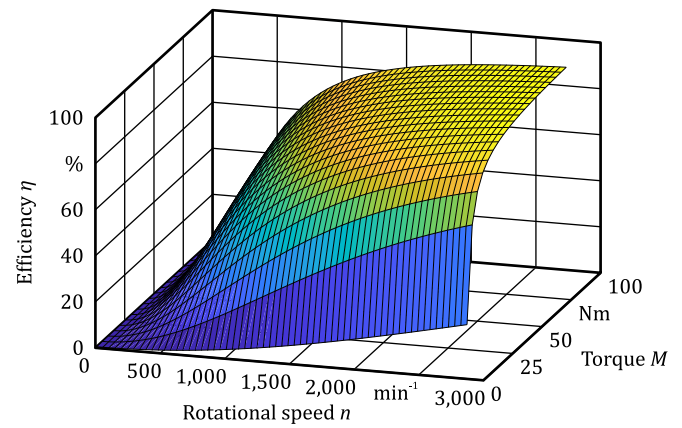

Fig. 11. Efficiency diagram of an exemplary 25 kW spindle induction motor (calculated by the WZL).

lower thermal dissipation of a more efficient motor also decreases the cooling demand, which further reduces overall energy requirements [6]. An analysis of the spindle market has shown a trend to higher spindle power and speed to increase the productivity of machining centres [193], which contradicts the reduction of energy losses in the main spindles. Fig. 11 shows the characteristic efficiency diagram of an induction motor and clearly illustrates the limited range for energy efficient operation. With induction and synchronous motors, a high energy efficiency can be achieved for high loads and rotational speeds. However, the energy efficiency drops drastically for small torques and low speeds. Despite a broader range of processing procedures, an energy optimal design would require that the motor is utilised near the rated operating point [201]. It also includes a specific limit for speed, maximum inertia and stiffness. A comparison between two main spindle designs for a milling process is provided in [2]. A detailed model to evaluate the load losses of a spindle is developed in [100].

Software-based changes for main spindle drives can be separated into the two categories of control system and operation. For optimising the control system, a look ahead algorithm is developed in [99], that controls the main flux of the induction motors in main spindle drives. By reducing the main flux, a higher torque-producing current must flow for the same torque, which weakens the controllability on the one hand, but also reduces the electrical losses of the induction motor for small loads on the other hand. Dependent on the expected load (estimated via expected cutting forces), the flux is increased or decreased respectively. Due to the inductive behaviour of induction motors, the flux can only be increased very slowly. The study also investigates the reduction of the PWM frequency. The energy loss during operation can be optimised by increasing the productivity of the machine. It includes a short run-up phase of the spindle to accelerate and decelerate the spindle rotor as little as possible [140]. In principle, it is advised to operate the spindle only as short as possible, which includes synchronising spindle acceleration and deceleration with rapid speed stages of feed drives [73,152]. The identification of optimal cutting parameters and operational parameters for work spindles is discussed in Chapter 6.

#### 4.1.2. Feed drives

Compared to the energy intensive auxiliary components, such as the cooling system or hydraulic unit, and the work spindle, individual feed drives have a rather low electrical energy requirement [227]. Nevertheless, feed drives play an essential role in energy efficiency because of their extensive use in automated production machines and their proximity to the process. This is because of their ability to determine how fast a specific process can be run and how many settings are needed for each process. Machines which combine several processes due to their structure of feed drives can decrease the idle-running time and, thus, the machine's energy demand (see the investigation for turning and milling machines in [150]). In [107], it was discovered, that a double spindle system can reduce the required

energy by up to 80% when compared to the use of two individual machines. Lightweight construction measures for movable components such as slides and work tables further help to decrease the energy demand of feed drives [184, 202].

The efficiency of feed drives in milling, grinding and turning machines also depends very much on the drive system structure. For instance, gantry or master-slave systems usually create a certain force between their components, increasing the idle current flow of all operating motors and, thus, their losses. A hybrid concept consisting of linear motor and ball screw drive is developed in [162]. An energy efficient linear motor creates the rapid speed movements and increases the dynamic ability of the system, while the ball-screw drive supports the high forces. Hence, the force of the linear motor and the torque of the motor from the ball screw drive are kept small, which further reduces the losses and the necessary cooling of the linear motor.

Because the peak power of machine tools and the highest energy demand of feed drives occurs during rapid movements, a trade-off has to be made between maximum productivity and efficiency of the feed drives. High acceleration and velocity of feed drives create high torque-producing currents, which result in increased copper losses. However, as described in Section 4.1.1, the efficiency of the whole machine tool can be increased by increasing the productivity (e.g. reducing rapid movements, optimising the tool path, minimising tool changes) [93,165]. Due to the high energy demand of auxiliary systems and the comparatively small energy requirements of drive systems, the application of high feed rates and acceleration in cutting operations has the potential to increase the overall energy efficiency of the production system [158]. Further improvements can be achieved by changing the interpolator and control. In [91], the equivalency of the different axes of a parallel kinematic is used to find specific paths of movements of the axes that create the lowest energy demand. Laptev et al. propose a non-linear control technique approach (sliding mode control) for the current control of feed drives [133]. Advantageous is that the non-linear behaviour of the pulse width modulation can be controlled more efficiently. In some operating points, active power can be decreased by more than 30%.

#### 4.2. Bearing principles

Bearings and guideways transmit forces and guide rotational and linear movements. Today, these components are usually equipped with rolling elements. Basic requirements are high accuracy and stiffness, as well as minimum friction, excellent heat transfer, damping characteristics and protection against wear [15]. Regarding energy efficiency, it is essential to minimise the friction losses by an appropriate bearing design and sufficient lubrication. In other approaches, energy efficiency is characterised by thermal losses [144]. The occurring losses in the bearings strongly depend on the operational conditions [93].

The work spindle bearings dissipate much energy mainly due to high friction between the rolling elements and the inner and outer ring caused by high rotational speeds and loads. The proportional energy losses due to friction in the bearings for different operational conditions of a motor spindle are presented in Fig. 12. With increasing rotational speeds, the motor power and the friction losses usually rise [198].

Jedrzewski modelled energy losses in spindle bearings based on a holistic approach [114]. He divided the losses into independent factors such as speed and preload and dependent factors such as oil viscosity, deformation and heat output. He found that the power losses in the spindle bearings in a rigid arrangement are significantly affected by the length and the material of the spacer [115]. With a new lubrication injection system for the inner ring, much higher speeds can be reached in comparison to the usual oil-air lubrication [13]. The state of the art of energy efficient spindle bearings shows that the improvement of their frictional behaviour is a significant objective.

The design of the bearing is usually based on the friction torque. With increasing load, the contact surface and normal forces increase, which leads to a higher elastic deformation and higher friction. To achieve an even load distribution and increased stiffness, spindle

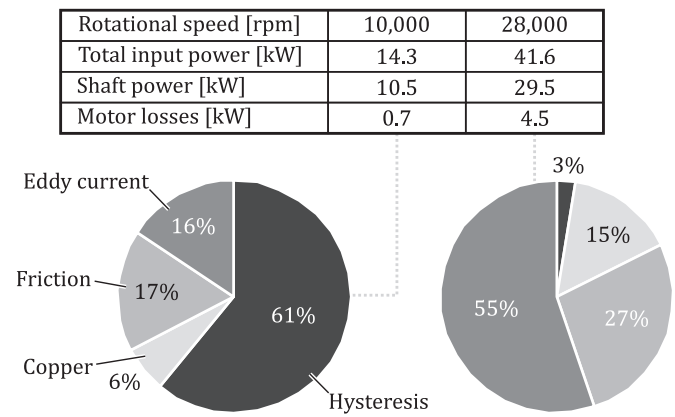

Fig. 12. Proportional energy losses in an investigated motor spindle for different operational conditions [198].

bearings must be preloaded, which, in turn, increases friction [37]. Higher rotational speeds result in higher relative velocities in the lubrication film and higher friction. These influencing factors show that the spindle bearings in machine tools have limited applications towards achieving energy efficiency. The frictional behaviour can be improved by lubrication, by appropriate bearing selection and arrangement and by an optimisation of the contact geometry [35,178]. To reach higher speeds, the use of oil-air-lubrication for the bearings is widespread. This approach requires an additional air pressure system, which in return increases the energy demand. The amount of oil plays an important role: Too much oil results in high splash losses and too little oil leads to an insufficient lubrication film, high friction and wear [186]. In addition, the incoming air dissipates the resulting heat. For lower requirements on the rotational speed, grease lubrication can be used. In this case, there are no further supply systems for the lubrication necessary, which leads to a lower energy demand.

In the past, hydrostatic bearings were also used as shaft bearings for spindles. The advantages of this bearing type are lower friction, higher running accuracy and stiffness, as well as no risk for stick-slip effects. Because of the high manufacturing effort and high energy demand of the additional hydraulic system, this technology has not been used in the field of conventional machine tools [42]. In ultra-precision machining, e.g. for the manufacturing of fuel cell components or metal components for mobile phones, aerostatic bearings are widely used [74]. In comparison to hydrostatic bearings, this bearing type has an even higher running accuracy as well as a lower friction and heat generation. As a result, permissible speeds can reach up to 100,000 rpm. Similar to hydrostatic bearings, the manufacturing costs are high and the additional air pressure system involves an increased energy demand [42].

Due to their very low frictional torque and high running accuracy, electromagnetic bearings are also suitable for high rotational speeds. The load-carrying capacity is achieved through electromagnetic forces, which are created through an electromagnetic field between the rotor and the stator of the bearing and adjusted by a control unit. By guiding the rotor on certain eccentric tracks to a degree, imbalances can be compensated by the active bearing. In contrast to aerostatic bearings, the air gaps in electromagnetic bearings are relatively large with up to 0.5 mm, which reduces the manufacturing effort. On the other hand, the use of active components, i.e. electromagnets, sensor systems, control and power electronics, results in relatively high energy requirements. The actual energy demand depends on the size and electrical design of the electromagnets, as well as the used current amplifier technology. However, the power draw of electromagnetic bearings and guides is usually independent from rotational speed or feed rate. Furthermore, the base load of the active system, e.g. the required energy to enable levitation or provide a bias current to create a preload, is usually significantly higher than the expected load resulting from the process. Due to these characteristics, electromagnetic bearings are more suitable for high speed cutting in machine tools [42].



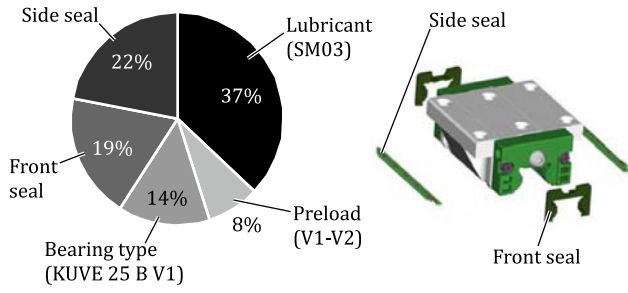

Fig. 13. Proportion of the shifting force in a four-row ball circulation unit (type: KUVE 25 B) [75].

Overall, the additional supply systems are one of the main reasons for the low energy efficiency of the alternative bearing principles in comparison to ball or roller type spindle bearings. As a result, they are rarely employed in machine tools in comparison to conventional spindle bearings.

Linear guideways enable translational feed motion during the manufacturing of components. Rolling elements are usually applied with high loads and much lower rotational speeds in comparison to work spindle bearings. In [198] it is stated that the axis drive accounts for approximately 19% of the total energy demand of the machine tool. The composition of the shifting force for a linear guide of the type KUVE 25 B is given in Fig. 13. The diagram shows that the lubricant (37%) and the seals (41%) have the biggest influence on the friction behaviour of the guide.

Ispaylar stated that besides the friction in the rolling contact point, the friction in the deflectors and inlet zone has to be considered. The friction in the wipers in particular, which makes up approximately 50% of the overall friction in the guideway, is the primary influence on the losses [112]. Kunc developed a parameterised friction model. With the friction force  $F_{fric}(v,L)$  measured from four loaded cases referenced to an unloaded case, a speed-dependent load factor characteristic can be estimated, which is presented in Fig. 14 [40]. Consequently, an increased preload also results in increased friction losses. With regard to stick-slip effects, this influence has also been validated by Rahmani et al. [171]. Furthermore, Denkena et al. developed and verified a jerk-decoupled feed axis model with spring-damper-elements [58]. With an energy-optimised dimensioning, the energy losses related to the jerk influence can be minimised by up to 50% [98].

Besides linear direct drives, feed drives can also be constructed with ball screws, which transfer rotary motion to linear motion. Ball screw drives consist of a spindle, rolling elements, a nut and a ball return system, as well as sealing elements as shown in Fig. 15. They have a high efficiency which can reach up to 95% depending on the

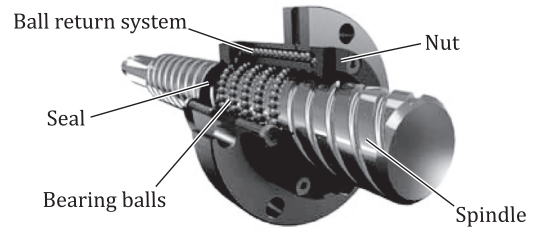

Fig. 15. Structure of a ball screw drive [155].

operational condition [168,215]. Naturally, the efficiency decreases with increased preload due to friction losses [209].

Regarding the friction behaviour in spindle bearings and linear guideways, there is already vast knowledge about modelling and optimisation of their operational behaviour. Nevertheless, considering the steadily increasing requirements for the performance of the machine components, the improvement of these friction characteristics is ongoing research.

4.3. Interim conclusion

Even though support units often dominate the energy requirements of machine tools, work spindles and feed drives regularly account for a considerable portion of the overall energy demand (see Fig. 9). Although it is generally possible to reduce the weight of movable machine tool components through topology optimisation and lightweight materials in order to reduce the energy demand for acceleration and deceleration [149], design measures concerning the structural components of machine tools are excluded at this point. This is justified by the fact, that the expected gains in terms of energy efficiency are rather small when feasible weight savings and common energy shares of the feed drive system are considered (see Section 3.3). A generally valid approach to increase the energy efficiency of machine tools is to reduce the operating time by increasing the machining speed, which in turn requires increased drive and bearing performance. However, in this case a high energy efficiency of the entire machine tool can only be ensured if energy intensive components are completely switched off when not in use, see Chapter 6. Fig. 16 provides an overview of the most important energy efficiency measures for individual main units; Table 1 summarises relevant literature on the energy efficient design of main units for machine tools.

Electrical drives typically have a high degree of efficiency. Hence, the efficiency optimisation of servo drives offers only low savings

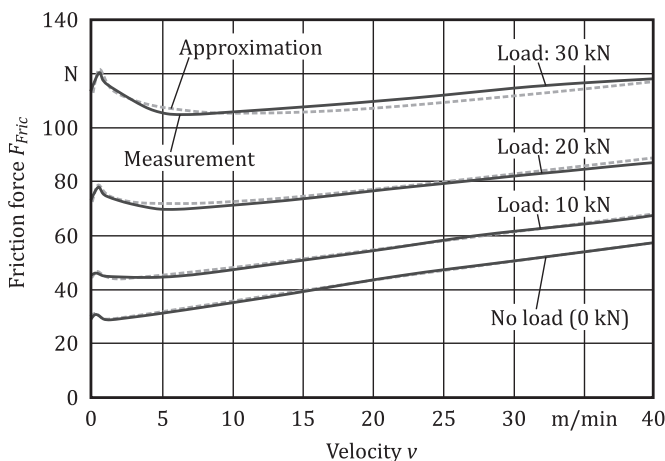

Fig. 14. Approximation and measurement of the velocity- and load-dependent friction characteristic for a linear guide [40].

**Overall objectives**

- Minimise ohmic losses in coil windings and friction losses in general
- Reduce friction in bearings and linear guides
- Increase efficiency of main units to decrease load on support units

**Work spindle (4.1.1)**

- Motor selection (synchronous or reluctance motors)
- Spindle design (directly or indirectly driven or hybrid)
- Control based measures (flux weakening, PWM pattern or frequency change)

**Feed drives (4.1.2)**

- Structure design (gantry, master-slave or multi-spindle system)
- Interpolator preferences (acceleration or deceleration)
- Control based measures (sliding mode control)

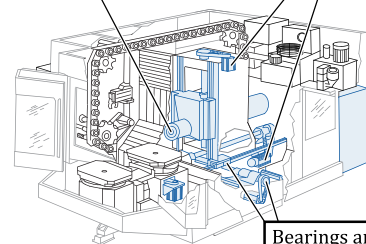

**Bearings and guideways (4.2)**

- Optimisation of lubrication

Fig. 16. Most relevant energy efficiency measure for machine tool main units.

**Table 1**  
References for energy efficiency main units

Main unit	Source
Drives in general	[11,14,32,84,104,105,124,212]
Work spindle	[2,6,9,99,140,193]
Feed drives	[15,135,162,184]
Spindle bearings	[35,93,144,186]
Alternative bearing principles	[42,74]
Linear guides	[40,58,75,98,112,198]
Ball screws	[168,215]

potential. Instead, the appropriate selection of more efficient motor types represents a promising approach. Moreover, the list of effective measures includes software-based changes, such as adjustments of the interpolator or PWM preferences and load-dependent adaptation of the control parameters.

Ball bearings represent the state of the art in conventional machine tools. Alternative bearing principles are only used in specific applications where their benefits outweigh the additional expenses. With ball bearings, a trade-off between the target parameters of applicable feed velocity, achievable precision and resulting friction force (which directly correlates with the energy efficiency) has to be considered. Again, a demand-oriented adaptation of the preload allows for both increased performance and energy efficiency.

## 5. Support units

Usually the support and auxiliary units dominate the overall energy demand of modern machine tools, see Chapter 3. In terms of energy efficiency, this represents an undesirable situation, since support units do not directly contribute to the value adding process. Nevertheless, they are indispensable to put the machine tool into an operational state. Naturally, reducing the support units' energy demand presents a practical approach to increase the overall energy efficiency of machine tools. However, an essential prerequisite is that the implemented energy efficiency measures do not affect process stability and machining results.

The following section describes the main findings and relevant measures concerning the energy efficient design of machine tool support units. The subsections address the components that account for the most significant shares of the total energy requirement, i.e. machine cooling, cutting fluid supply, and hydraulic system. Another subsection outlines further measures concerning support units with a smaller, but not negligible, impact on the total energy demand.

### 5.1. Cooling systems

The main task of cooling systems in machine tools is to dissipate the generated heat and, thus, to control the temperature of various components which determine the dimensional quality of the machined workpiece, e.g. spindles and feed drives, bearings and guideways, machine frame and other structural elements as well as cutting and hydraulic fluids. Likewise, the machine's control cabinet, which contains control and power electronics, requires cooling. The reliable operation of the cooling system is therefore crucial for maintaining the required machine tool performance, since local heat build-up may cause thermally induced displacement of structural components and may ultimately affect the functionality of sensitive units or even damage them permanently [144].

In many cases, the cooling system accounts for the most significant amount of a machine tool's electrical energy demand. The refrigeration compressor often dominates the energy requirements, fluid pumps and condenser fans regularly require a lesser amount of electrical energy [33]. Possible approaches to increase the energy efficiency of the cooling systems include the optimisation of individual components, such as pumps and compressors, and the overall circuit design. Here, many approaches aim at a need-based design and operation of the cooling system. Other (indirect) approaches focus on reducing the load on the cooling system, e.g. by minimising thermal

losses and integrating components with an extended thermal operating range, see Chapter 4.

#### 5.1.1. Hot gas bypass and compressor cooling units

Modern cooling systems consist of a dual circuit as depicted in Fig. 17 [53]. Tempered water is conveyed through the machine tool; the thermal energy of the return flow is transferred to a separate refrigerant circuit using an evaporator. The gaseous refrigerant is then compressed and condensed, thus, withdrawing thermal energy from the refrigeration circuit. To prevent a temperature drop below a specified lower limit, a hot gas bypass valve reroutes the refrigerant directly to the compressor, leading to a highly unfavourable energetic state.

A standard measure to improve the cooling system's energy efficiency is to install a clocked compressor, which can be switched off, when not in use [33]. Typically, a 2-point controller is used to switch the compressor on and off as soon as the coolant temperature reaches specified limits. This approach reduces the compressor's operating time and increases the energy efficiency compared to continuous operation with a hot gas bypass. However, the use of clocked compressors also has noteworthy limitations: The 2-point control inevitably leads to temperature fluctuations of the coolant, which, in turn, affects the thermal errors of the cooled components. Narrow temperature windows and short on/off intervals help to reduce the temperature fluctuations; however, frequent switching may affect the compressor's maintenance intervals and durability.

Mori et al. proposed an on/off control scheme for hot gas bypass cooling units with fixed switching intervals and investigated the trade-off between energy efficiency and thermally induced displacement [151]. For the proposed approach, the compressor was set to an operating point with maximum efficiency in the on state. The results of the experimental investigation show that the energy demand of the cooling unit was reduced by 25% compared to a state-of-the-art cooling unit with PID temperature control and hot gas bypass. At the same time, a TCP displacement of 3  $\mu\text{m}$  was measured. Regarding the heat generation of the coolant pump, an advanced approach included a complete pump cut-off. Here, the cooling unit's energy demand was reduced by 75% while a TCP displacement of up to 5  $\mu\text{m}$  was measured.

Another effective approach to increase the energy efficiency of cooling units is the use of variable speed compressors. Frequency inverter controlled compressors allow for the specific adjustment of the cooling capacity. As indicated by Mori et al., the efficiency of frequency inverter-controlled compressors deteriorates for low cooling capacities [151]. Nevertheless, the modulation of the cooling capacity with a variable speed compressor provides the possibility to completely eliminate the hot gas bypass. This solution involves further investment for frequency inverters and compatible compressors but also yields a significant saving potential of up to 70% [33].

Otherwise, scroll compressors can be used to control the cooling capacity without a hot gas bypass [8,33,116]. These compressors consist of two interleaving spirals (Fig. 18). In operation, one spiral follows an eccentric circular path, thus, gradually pumping, compressing and pressurising the enclosed medium over a single rotation as shown in the lower part of Fig. 18.

As a design variant of the conventional scroll compressor, digital scroll compressors allow for a pressure modulation from 10 to 100%

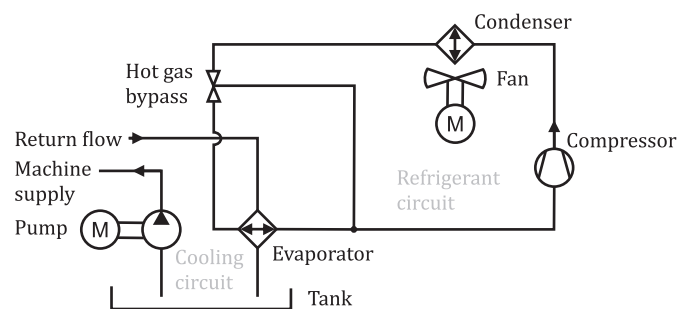

**Fig. 17.** Typical compression cooling system with hot gas bypass [101].

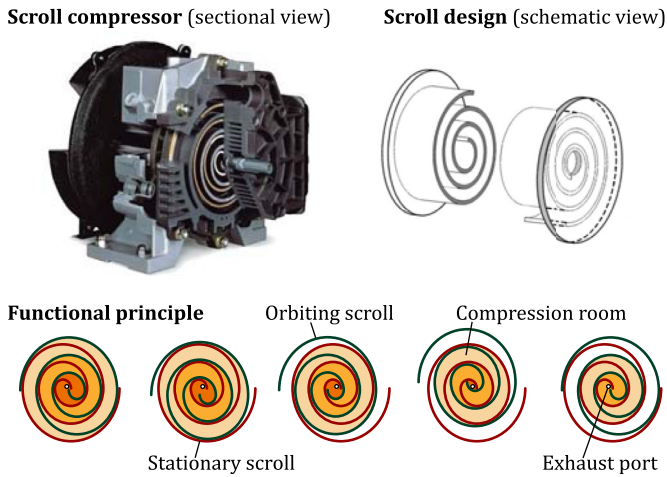

Fig. 18. Setup and operating principle of scroll compressors [206].

[33]. This is achieved through a temporary separation of the two spirals by approximately 1 mm, which results in a pressure equalisation between the intake and discharge side. Pressure build-up is not possible in this load-free state; thus, the energy demand drops to idle level. The ratio between regular compression and load-free operation over a rotation cycle of the moving spiral determines the degree of modulation. Advantages of this technology include a reduced number of moving parts, a constant actuator speed resulting in continuous refrigerant circulation and less electromagnetic interference, and precise temperature control. Brecher et al. investigated an optimised digital scroll compressor in comparison to a state-of-the-art hot gas bypass cooler and demonstrated saving potentials between 20% (spindle under full load) and 62% (machine in idle mode) [33]. Moreover, the thermally induced displacement of the tool centre point was reduced from 40 to 30  $\mu\text{m}$ .

5.1.2. Air cooling units

Air cooling units present an energy efficient alternative to compressor systems. With this cost-effective approach, a large passive heat exchanger with a variable speed fan fully substitutes the refrigerant circuit (see Fig. 19 on the left) [53,217]. The cooling capacity is adjusted via the fan speed and allows for a variety of set-point variables, e.g. the temperature of a specific machine component or the ambient temperature (see Fig. 19 on the right).

Since air cooling systems cannot achieve fluid temperatures below the ambient level, their use in the machine tool industry has been neglected so far. However, Denkena and Hülsemeyer investigated an air cooling system and demonstrated a reliable operation for usual ambient temperatures in production environments [56,101]. Initial results indicate a saving potential of up to 70%. Moreover, no negative impact on the machine tool accuracy, i.e. the displacement of the tool centre point, was detected for the investigated load cycle despite an increased temperature of the cooling fluid.

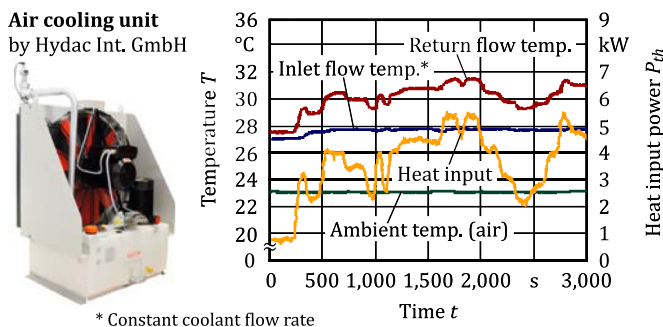

Fig. 19. Setup and temperature control of a variable speed air cooling system [101].

Regel et al. also used an air cooling system to investigate a novel method for the evaluation of cooling measures for energy efficient machine tools [175]. A high-performance concrete frame equipped with a linear axis, an air cooling unit and several coolant circuits to cool down individual components was used as a test bench. Based on a referenced system model, a sensitivity analysis regarding the thermo-energetic efficiency was performed. As a result, the impact of cooling measures and control parameters on the temperature distribution of the test bench was identified. Accordingly, the investigated method enables practical design of demand-oriented and energy efficient air cooling systems for machine tools.

5.1.3. Cold water admixture

The addition of cold water is another possibility to control the temperature of machine tools without a separate refrigerant system [8]. To adjust the temperature of the coolant, fluid is taken from the storage tank, cooled down to a defined temperature using a compressor, then returned to the tank and mixed with stored coolant. The approach requires a large tank, where the cold water and return flow from the machine tool are mixed to achieve the desired temperature. Eventually, the system requires some time after start-up to cool down the tank volume. Afterwards, it works efficiently for small loads.

5.2. Cutting fluid supply systems

Cutting fluids, also known as metalworking fluids or cooling lubricants, perform various essential tasks during the machining process to ensure workpiece quality, to reduce tool wear and to increase process productivity [21,43,44]. Primary tasks include cooling and lubrication of the contact zone as well as chip transport and breaking (chip control). However, the use of cutting fluids entails considerable economic and ecological costs [52]. The economic costs cover the costs of the procurement, processing and disposal as well as the electrical energy for pumps and preparation equipment, e.g. filter systems. The ecological costs are often associated with the environmentally harmful composition of the fluid, which results in health risks for the machine operator and environmental damage in the event of improper disposal [21]. Despite significant progress in the field of minimum quantity lubrication and (near) dry machining [216], the use of conventional cutting fluids is still inevitable for a wide range of machining operations. At the same time, it has a considerable impact on the overall energy demand of machine tools [122,143].

The cutting fluid supply system is usually designed as a circulation system and consists of supply, recirculation and conditioning. Fig. 20 illustrates these three stages as well as their distinct components, which allow for an individual energetic optimisation. The following subsections provide an overview of energy efficiency measures for practically relevant design variants of cutting fluid systems. In particular, the various pumps within the cutting fluid circuit as well as the cooling systems account for a large share of the electrical energy demand [143]. Regarding the temperature control of cutting fluids, the results from Section 5.1 can be applied. Moreover, the deliberate supply of cutting fluid through directed nozzles or tool-integrated channels enables vastly improved cooling of the cutting zone, which is an essential requirement for increasing the cutting performance without sacrificing process stability or machining quality, as proposed in Chapter 4. Alternatives to common cutting fluid supply concepts rather concern the process design and the operation of the machine tool, and are therefore addressed in Chapter 6.

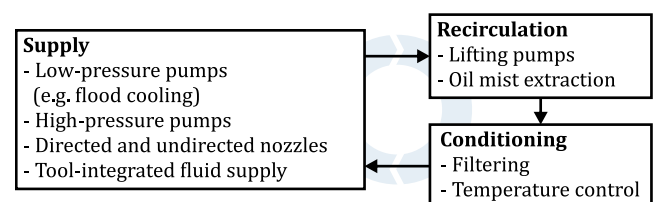

Fig. 20. Stages of the cutting fluid circuit.

### 5.2.1. Low-pressure cutting fluid supply

The most common concept is to flood the area of chip formation with cutting fluid. Depending on the machining situation, nozzles are used to ensure directional supply [95]. However, the cutting fluid usually flows uncontrollably into the contact zone. Optimising the efficiency and effectiveness of the cutting fluid supply is particularly important for grinding processes due to the high amount of friction and heat generation compared to processes utilising geometrically defined cutting edges, like milling or turning. Hence, Madanchi et al. investigated the effects of nozzle design and alignment in grinding processes and identified a significant impact of the regarded variables (nozzle type, design, and position) on the energy efficiency of the cutting fluid supply [142].

Due to the consistent flow resistance of the supply lines and nozzles, low-pressure pumps operating at constant speed are used to convey the cutting fluid. In this case, appropriate dimensioning of the pump power is crucial for high efficiency. The design of the machine tool's cutting fluid circuit usually follows a fairly practical approach. It is currently not known whether optimisation approaches concerning pipe diameters, cross-section changes and deflection elements are applied to increase the energy efficiency of the machine tools' fluidic systems. However, small bore diameters and, thus, large flow resistance are found on coolant nozzles and tools with internal cooling. Hence, these components present the most sensible starting point for further optimisation. But even if an appropriate pump and circuit design is possible for low-pressure systems, further savings potential remains relatively low. This is because the cutting fluid supply as well as other auxiliary pump systems, e.g. lifting pumps for fluid recirculation, are activated by NC commands or float switches [32], which already represents a demand-oriented and thus efficient approach. Extending demand-oriented control concepts to other auxiliary pump system, such as bed flushing, provides further energy saving potential.

### 5.2.2. Internal high-pressure cutting fluid supply

Naturally, the power rating of fluid pumps increases with higher pressures and flow rates. Nevertheless, the use of an internal high-pressure cutting fluid supply offers high potential for increasing the overall energy efficiency due to considerably improved process stability and productivity [20,56,57,119,125,127,174,182]. In particular, the investigations of Sangermann provide an in-depth look at the technological cause-effect relationships for machining operations with internal high-pressure cutting fluid supply [182].

High-pressure pumps for the internal cutting fluid supply regularly provide pressure levels of 80 to 100 bar; in some cases, up to 300 bar can be achieved. The energy efficient operation of these high-pressure coolant pumps in combination with different tools requires the option to adapt the hydraulic power to varying flow resistances. For a constant speed pump, this can be achieved with a bypass valve for pressure relief in case of an increased flow resistance. However, this solution leads to poor energy efficiency. A more promising approach is the demand-oriented control of the pump power via frequency inverters [32]. The use of different tools with individual flow resistances results in specific system characteristics of variable speed pumps. Hence, adjusting the pumps' operating point for individual tools yields a substantial energy efficiency potential, as depicted in Fig. 21. Since this approach ultimately aims at the modification of the machine tool's control system, it is discussed in more detail in Section 6.3.

In summary, the use of internal high-pressure cutting fluid supply can increase the overall energy efficiency of machine tools – as long as the technology allows for increased material removal rates, which compensate the temporarily increased energy input during machining for an improved energy budget. This condition must be assessed individually since certain use cases may benefit from the application of high-pressure cooling concerning tool life and process stability but still suffer from lower energy efficiency [69]. Furthermore, there are still significant potentials regarding the demand-oriented adjustment of the cutting fluid supply parameters (i.e. flow rate and supply

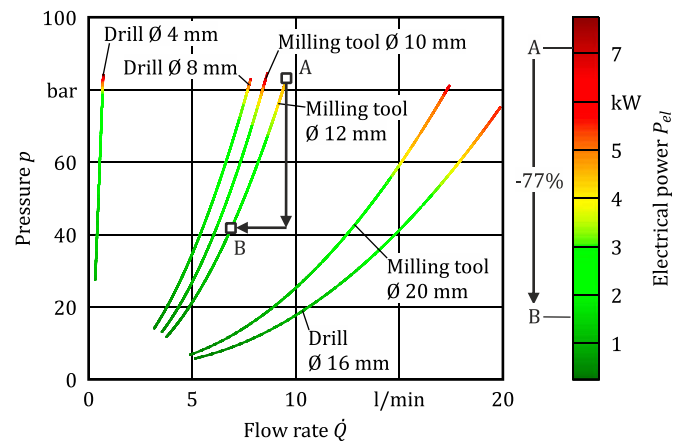

Fig. 21. Pump characteristics and power demand for a machine tool with various cutting tools [56].

pressure), which allows for a drastic reduction of the energy demand while maintaining the technological benefits of the internal high-pressure cutting fluid supply.

### 5.2.3. Recirculation and conditioning of cutting fluids

After application in the workspace, the cutting fluid must be removed from a machine tool for filtering and often also for temperature control. The cutting fluid is usually drained into a basin underneath the machine tool and then transported to the treatment stage using lifting pumps. Since the cutting fluid is dispersed in the air during the machining process, especially when using high-pressure supplies, it is necessary to remove the airborne lubricant drops from the workspace. Oil mist extraction systems consisting of suction units and oil mist separators are used for this purpose.

To ensure energy efficient recirculation of the cutting fluid, the findings from Section 5.2.1 can be applied, meaning that appropriate dimensioning of the pump power according to real process requirements is a key factor. Apart from that, the lifting pumps are usually controlled by float switches, which present a simple but effective solution for demand-oriented operation. Here, it can be beneficial to use large basin capacities for long switching intervals to prevent frequent start-ups. Looking at oil mist extraction systems, oversizing is a common reason for poor energy efficiency. Need-based dimensioning of the suction system and adaptive control of the suction power via frequency inverters present reasonable solutions [53]. The control of the suction power based on the actual cabin air contamination presents a highly promising concept as studies by Denkena et al. concerning dust extraction for machining of carbon fibre reinforced plastic imply [54,55]. The proposed solution includes design considerations for strategically placed suction boxes and sensor-based control concepts for a demand-oriented and energy efficient dust removal from the machine workspace. Preliminary studies demonstrated a savings potential of up to 72% by reducing the operating time and suction power of the extraction system. It can be assumed that this concept can be transferred to the oil mist extraction system as well. However, this approach has not yet been investigated for the extraction of airborne cutting fluid particles.

Conditioning of the cutting fluid includes filtering and temperature control. For the latter, the findings from Section 5.1 apply. The removal of contaminants, such as metal particles and oils, is carried out by filter systems and oil skimmers respectively. In machine tool applications, belt filters are commonly used for cleaning the cutting fluid [197,214]. Depending on particle size and specifications for residual contamination, different variants of belt filter are applied [164]. Again, fluid pumps account for the largest share of the electrical energy demand and demand-oriented design and control strategies present evident energy efficiency measures.

Precoat filters present a technological alternative to belt filters but require a consistent flow rate for effective operation. Rahäuser et al. point out current deficits in state-of-the-art filter plants and present a retrofit for a demand-based flow rate control in precoat filter systems [170]. Based on a simulation of an existing plant, a saving potential of up to 73% was identified. Although the investigations were carried out for a central system supplying several machines within a plant, the results can also be transferred to decentralised filter systems.

### 5.3. Hydraulic units

Hydraulic units enable various functions in machine tools such as tool and palette changes, workpiece clamping as well as weight compensation for vertical axes. Furthermore, they provide hydraulic pressure for hydrostatic bearings and guides. Typically, hydraulic units are accountable for up to 10% of the overall electrical energy demand in machine tools [34]. In particular, hydraulic systems exhibit relatively high energy requirements in idle times due to leakage losses [38]. The following measures are available to increase the energy efficiency of hydraulic units:

- Pressure accumulators and intensifiers (booster),
- variable speed pumps,
- variable displacement pumps,
- directed seat valves,
- optimised components in the hydraulic circuit for minimal leakage.

Reducing the leakage of the hydraulic system through an optimised component design and the use of seat valves always leads to an increase in energy efficiency. Here, the potential savings increases with the system pressure. However, the benefits of design changes regarding pumps and accumulators heavily depend on the machine configuration and the use case. Fig. 22 provides an overview of fundamental design concepts for hydraulic systems in machine tools [101].

Constant speed pumps in combination with hydraulic accumulators present an efficient solution, when hydraulic power demand occurs sporadically. The accumulator allows for a fast response and the use of relatively small pumps with low power ratings. Different pressure levels can be achieved with multiple accumulators in combination with a single pump. Moreover, it is possible to deactivate the pump completely when no hydraulic power is required, reducing the losses to leakage within the hydraulic system [8,101]. However, this configuration becomes gradually inefficient when hydraulic power is required more frequently since frequent start-ups of the pump increase the thermal load of the hydraulic system. Variable speed pumps (usually driven by frequency inverters) enable a demand-oriented adjustment of the flow rate and of the resulting system pressure. Hence, they provide an energy efficient solution for machine configurations with fluctuating hydraulic power requirements [1, 101]. The lack of an accumulator results in a high power rating of the pump as well as continuous operation to compensate the leakage. Variable displacement pumps act as an alternative to variable speed pumps for controlling the hydraulic power without additional frequency inverters. They also require electrical energy to compensate for leakage losses and suffer from long reaction times. With regard to

energy efficiency, they provide a sensible solution for applications with high hydraulic power demand [101].

Since machine tools are commonly complex systems, the setup of hydraulic units also becomes more complex, e.g. by including several pumps and accumulators for low-pressure and high-pressure cycles. Accordingly, the application of single measures or the combination of several measures may lead to interactions and potential synergies. Even the composition of the hydraulic fluid influences the energy efficiency of the system [191].

Abele et al. demonstrated a reduction of the hydraulic unit's electrical power demand of 91% for a specified demonstrator process by implementing seat valves and accumulators [8]. Hülsemeyer confirms that the use of accumulators is the most energy efficient solution for low hydraulic power demand [101]. Brecher et al. compared a state-of-the-art hydraulic system consisting of two variable displacement pumps for low and high pressure with an optimised hydraulic unit including a (low pressure) variable displacement pump and a pressure intensifier [34]. The optimised setup reduced the leakage by 79%, but suffered from a slow response. Further research led to an advanced setup with a variable speed pump (for high pressures), a pressure intensifier and two separate accumulators for low- and high-pressure cycles [38,41]. With the optimised unit, pressure losses in idle mode were reduced by 90% and active power requirements were reduced by 26% compared to the state-of-the-art hydraulic unit. Furthermore, the optimised unit exhibited a lower thermal load. Looking at temperature control of hydraulic fluids in general, the results from Section 5.1 apply [139].

### 5.4. Other auxiliary units

The use of compressed air accounts for up to 10% of the total industrial energy demand in some countries [180]. Even though only a relatively small share is allocated to machine tools, energy optimisation of the compressed air supply network is inevitable to increase the overall energy efficiency. After the supply of liquid media and temperature control of machine components, the supply of compressed air for bearings, pneumatics and sealing applications requires a considerable amount of the total electrical energy demand of machine tools [214].

In general, compressed air systems suffer from a low degree of efficiency. Only 10 to 15% of the energy input is utilised for actual work [156]. The main causes for the low efficiency of the compressed air supply are waste heat and, most of all, leakage in connectors, valves and actuators [214]. The first logical step to evaluate losses is to monitor the air flow at several points in the supply network [92]. Simulation models can be applied to identify the actual compressed air requirements of the machine tool for a need-based design and control of the network. For example, Mousavi et al. presented a comprehensive modelling and control approach [153]. According to their findings, the most energy efficient approach is to cover the base load with an appropriately dimensioned fixed speed drive compressor and use variable speed drives to compensate for dynamic loads. Denkena et al. identified the air volume flow and not the pressure to be the relevant control parameter in compressed air supply networks [53]. Consequently, they recommended to provide a constant air mass flow and to increase pressure where required locally, e.g. by using side channel compressors or rotary piston blowers. Saidur et al. provided an extensive overview of literature concerning energy use and savings for compressed air systems [180]. Moreover, Nehler investigated additional non-energy benefits of energy efficiency measures in compressed air supply networks [156]. Overall, it is recommended to reduce the size of the network and the number of connected devices, e.g. by replacing pneumatic actuators with electro-mechanical actuators.

Another support unit with a certain saving potential is the chip conveyor. Usually, chip conveyors are continuously active or activated in timed intervals with no concern for the actual chip production, compare Section 3.1. Utilising process knowledge, such as the actual material removal per time unit, allows for the implementation of more judicious control strategies according to the immediate requirements

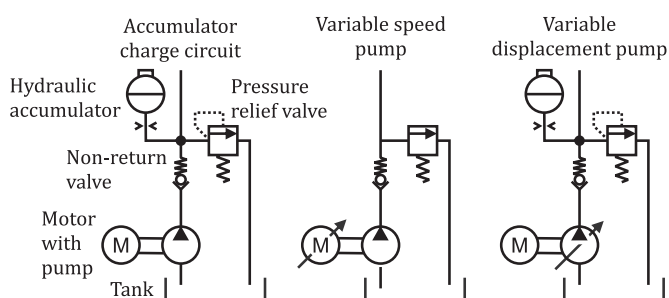

Fig. 22. Basic design concepts for hydraulic units in machine tools [101].

of the process [53]. Accordingly, it is possible to fully stop the chip conveyor in non-productive times or for finishing operations.

### 5.5. Interim conclusion

Auxiliary units typically dominate the overall energy demand of machine tools. The required energy input for the machine and process conditioning often exceeds the share for the actual value adding process. The most common reasons for inefficient support units are oversized or outdated components as well as poor design choices and unoptimised operation of individual components. Accordingly, a large variety of studies regarding the energy efficient design and operation of machine tool support units is available today, see Tab. 2 for an overview.

In general, the operation of support units is defined by fixed on/off cycles. Hence, demand-oriented approaches for the operation of specific auxiliary units hold a significant potential for increasing energy efficiency. This is impressively demonstrated by the example of the high-pressure cutting fluid supply, see Section 6.3. The challenge here is to determine reasonable supply parameters, i.e. cutting fluid flow rate and supply pressure, according to the actual requirements of the cutting process. The relevant question is how the flow rate and supply pressure affect the machining results and tool wear for specific workpiece material and cutting tool configurations. Consequently, this approach must be extended to other support units. For example, in the case of machine cooling, the cooling capacity can be adjusted according to required machining accuracy and permissible temperature levels for individual components. The question of actual process requirements and relevant cause-effect relationships in that context represents important objectives for future research. Further potentials lie in the area of media supply. In particular, the

**Table 2**  
References for energy efficient support units.

Support unit	Source
Cooling systems	[8,33,53,70,101,116,139,175,217]
High-pressure cutting fluid supply	[20,32,56,57,69,95,101,119,125,127,174,182]
Hydraulic system	[1,8,34,38,41,101,191]
Compressed air supply	[53,54,55,92,153,156,180]

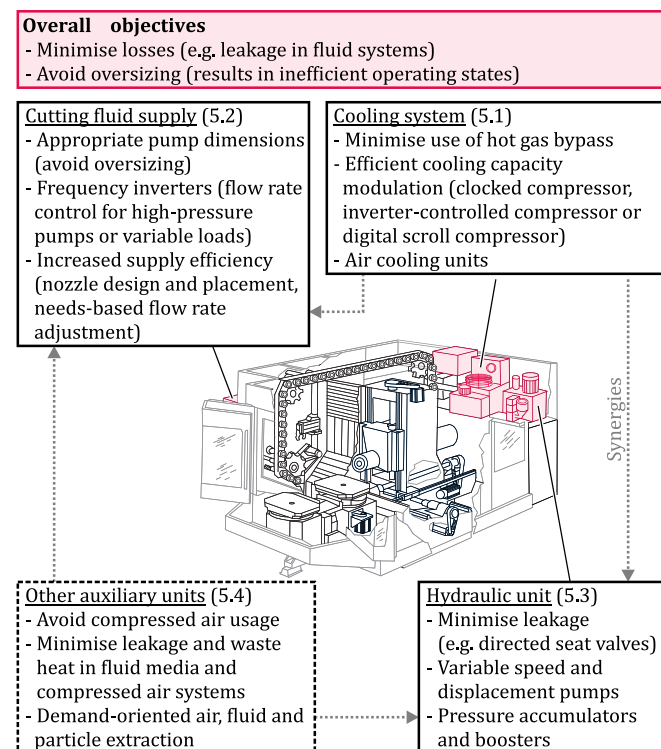

**Fig. 23.** Most relevant energy efficiency measures for machine tool support units.

replacement of pneumatic and hydraulic actuators with more efficient electro-mechanical actuators presents a sensible measure. Fig. 23 summarises the most relevant measures to increase energy efficiency of auxiliary components.

## 6. Operation of machine tools

The energy efficiency measures illustrated in Chapter 4 and 5 serve to design and optimise machine tool components, but the energy efficiency is also affected by the operating mode of the individual components and the entire machine tool. Approaches to reduce energy demand in operation include process-oriented control of the machine tool's operational state and its media supply systems, cutting parameter optimisation, as well as adaptive process control [66]. These measures can reduce the energy demand by up to 40% [159]. The following section provides an overview of measures to monitor and control the operational state of machine tools, energy efficient selection of process parameters, and demand-oriented process cooling strategies.

### 6.1. Monitoring and control of the operational state

A considerable part of the energy demand is caused in non-productive periods [62]. In the simplest case, improving the energy efficiency of a production system is a matter of switching off the machine tool at times of non-use, e.g. on weekends. However, thermal stability of the machine tool and fast ramp-up of the overall production system must be ensured at all times. An indicator for an inefficiently operated component is, for example, a continuous energy demand in operation, even if the production process does not require a corresponding amount of energy [26]. In this case, standby functions are integrated in the machine tool control system to automatically shut down unneeded components during production. Practical examples for this approach are presented in Chapter 7.

A further way of saving energy is to adapt the operational state of the machine tool to the available energy supply [134]. This approach is summarised under the term energy flexibility. Over the recent years, energy flexibility has gained increasing interest [28,166,167,187,189]. Reasons for this are rising energy prices but also a more volatile availability of electricity due to an increasing fraction of renewable energy sources.

In order to estimate the energy demand of machine tools at different states of operation (e.g. standby, air cutting or machining), reliable models are required. Exemplary models based on the operational state of machine components can be found in [48,93,136]. Yoon et al. introduced a model, which consists of four summands: the constant energy demand of the machine tool  $E_{Const}$ , the energy demand of the spindle  $E_{Spindle}$ , the feed rate dependent energy demand  $E_{Feed}$  and the cutting energy  $E_{Cut}$  [221,222]. To detect the different states automatically, Vijayaraghavan and Dornfeld developed a framework for an automated energy monitoring of machine tools [211]. Dietmair and Verl presented a state/transition model of a machine tool to predict the energy demand based on usage profiles of the different machine states [67]. By doing this, they could not only accurately predict the energy usage during the material removal process, but also for events like start-up of the machine tool. In a sophisticated approach, Abele et al. established a machine tool model that encompasses sub-models of the machine tool components [5]. By connecting the machine model to a machine control system, actual NC-codes can be executed and the energy demand can be simulated prior to the machining process.

### 6.2. Cutting parameters

According to the analysis presented in Chapter 3, the energy demand in machining is usually dominated by the support units of the machine tool. Consequently, reducing machining time by increasing the material removal rate  $Q_w$  appears to be a promising approach to lower the energy demand. This approach is also in agreement with Eq. (1), since a higher  $Q_w$  leads to a higher utilisation of the main spindle.

In an extensive study, Gutowsky et al. analysed and modelled the variable energy demand with respect to the material removal rate [89]. While the results simplify the actual effect of different process parameters, they allow a comparison of a broad range of manufacturing processes. However, Kara and Li pointed out that the used factors in the proposed model are not clearly defined and, thus, the model's applicability is limited [136]. Therefore, they developed an approach based on the specific energy demand. They validated their model by experiments and found out that higher  $Q_w$  lead to a lower specific cutting energy  $e_c$ . Nevertheless, they stated that the energy demand depends strongly on the use case. For example, a higher  $Q_w$  leads to a lower  $e_c$ , but also to higher temperatures and tool wear and, thus, requires the use of cooling lubricant, which, in turn, increases the overall energy demand [122]. It should also be noted that the same  $Q_w$  can be obtained using different process parameters, e.g. in milling the cutting velocity  $v_c$ , the tooth feed  $f_t$ , the cutting width  $a_w$  and the cutting depth  $a_p$ , which have a high influence on spindle load, tool wear and process cooling requirements.

A more detailed view on the influence of different process parameters on the energy demand in milling is given by Draganescu et al. [72]. The results show that the depth of cut and the feed per tooth have the highest effect on the specific energy demand. These results are supported by Rentsch and Heinzel, who were able to reduce the energy requirement for a milling process by 28 to 35% by doubling the feed rate [176]. Similarly, Yan and Li identified the width of cut as the most influencing factor on the cutting energy demand in milling within a sensitivity study [219]. Based on these findings, they reduced the energy demand by 18% by adjusting the process parameters while keeping the material removal rate constant. Similar potentials were identified for parameter optimisation in turning [120,138]. Schlosser et al. analysed the variation of process parameters in drilling [185]. The main result is an energy saving potential of 5% through shorter processing times caused by higher feed rates and an increased cutting velocity. Regarding grinding processes, Hacksteiner et al. recommend a high equivalent chip thickness to optimise the specific cutting energy [90]. Barrenetxea et al. suggested the use of process cycles with defined feed and speed profiles to reduce the energy demand in grinding [24]. In general, it can be summarised that the material removal rate should be adapted by increasing the undeformed chip thickness and width rather than the cutting speed. However, the required surface quality must always be ensured and taken into account when optimising the process parameters.

Aiming to support parameter optimisation in process planning, energy demand models are widely investigated and parameterised for different machining operations, e.g. turning, milling, or grinding. Since it has been emphasised in the literature that the environmental impact of machine tools results mainly from their demand for electrical energy, most models are based on this energy form [227]. Generally, a distinction can be made between physical and empirical models. Examples for physical energy or power demand models are presented in [25] or [154]. However, physical models are difficult to obtain and, in most cases, limited to the energy demand closely related to the process features. Thus, the machine tool, part and tool features or friction effects are often not taken into account. To consider these factors, empirical models are very common. Within this group, models can be further categorised into static and dynamic, deterministic and stochastic, as well as discrete and continuous models. Abele et al. provide an extensive overview of different modelling approaches [7,76,94,132]. In addition to explicitly formulated empirical models, AI methods are also used for the identification of non-linear relationships between variables [72]. Examples are given in [31] and [169].

While these models offer insight into general correlations between process parameters and the energy demand, the application is usually limited to simple workpiece geometries. In order to evaluate the energy demand prior to machining in an industrial environment, it becomes necessary to analyse the CNC tool path. This offers the potential to adjust the tool path accordingly and to shorten processing times by minimising air cutting movements [18,63,173]. Balogun et al. developed a framework to parse NC-codes and relate the G-code fragments to operational states [23]. In an experimental study,

they showed a deviation of 12% between calculated and measured energy demand in machining of an exemplary workpiece. However, the approach does not consider neither the actual tool trajectory nor the tool engagement. Especially trajectory and feed rate optimisation of the tool path supports high productivity and, consequently, a high utilisation of the machine tool. Moreover, the workpiece quality can be ensured, which reduces scrap. Examples for optimisation techniques are given in [16,78,224]. In this context, virtual machining will play an increasingly important role in the future. Similarly, approaches for online control of the feed rate or chatter suppression are not only beneficial with respect to productivity, but also from an ecological point of view.

However, a sole focus on processing time does not consider effects on the auxiliary energy demand in the form of tool wear or cutting fluid usage. Aggarwal et al. adjusted process parameters in turning with regard to the cooling strategy. A minimisation of process parameters in combination with cryogenic cooling led to a minimal energy demand. Here, the cooling strategy had the biggest impact, followed by depth of cut and cutting velocity [12]. Based on a semi-analytical model, Mativenga and Rajemi presented an approach to minimise the energy requirement for turning operations by adjusting the material removal rate. By separating the energy demand into four parts (setup, material removal, tool change and cutting edge), they were also able to consider the embodied energy per used tool [143,172]. Wang et al. used a non-dominated sorting genetic algorithm to evaluate the optimum between product quality, manufacturing cost and energy demand, including the embodied energy of tool and cutting fluid, to determine cutting depth, feed rate and cutting speed for a turning process [213].

Adjusting the macro and micro geometry of the cutting tool as well as its coating can reduce cutting force and the required specific cutting energy. However, these effects are rather small compared to the fixed energy share of the process. Thus, cutting tools should be designed to withstand high material removal rates and display long tool life in order to maximise the utilisation of the machine tool. A timely replacement of worn cutting tools can be supported by monitoring the spindle current [165,227].

### 6.3. Process cooling

Reducing the energy demand of the cutting fluid supply holds a significant savings potential due to its typically high share of the machine tool's overall energy requirement. Although there has been great progress in the area of alternative process cooling strategies [141], conventional flood cooling and lately internal high pressure cutting fluid supply are the predominant concepts used in the industry.

#### 6.3.1. Efficiency measures for conventional cutting fluid supply

The efficiency of flood cooling systems can be increased by adjusting the control variables of the cutting fluid supply according to the cutting conditions [195]. Denkena et al. analysed the flow rate variation for an internal high-pressure cutting fluid supply in turning, milling, and drilling with various cutting speeds and feed rates in consideration of the technological risks, i.e. tool wear. Looking at the system characteristics of a machine tool with a variable speed high-pressure fluid pump (compare Fig. 21), small changes of the cutting fluid flow rate had a significant impact on the electrical pump power without affecting tool wear for a given set of cutting parameters.

Further investigations focussed on the effects on tool wear and work spindle power in machining of Ti-6Al-4V with reduced cutting fluid flow rates. The results confirm the potential of a demand-oriented control of the cutting fluid system [56,57]. Based on these results, three approaches to adapt the cutting fluid supply parameters to the actual cutting conditions were presented: a manual setting (Approach 1), a CAx-based adjustment (Approach 2) and a simulation-based setting (Approach 3). In the manual setting, optimised flow rates for each tool configuration were entered directly into the human machine interface. This strategy, though, requires additional default values in the parameter catalogues of the tool manufacturers. The CAx-based approach used process information, like roughing and

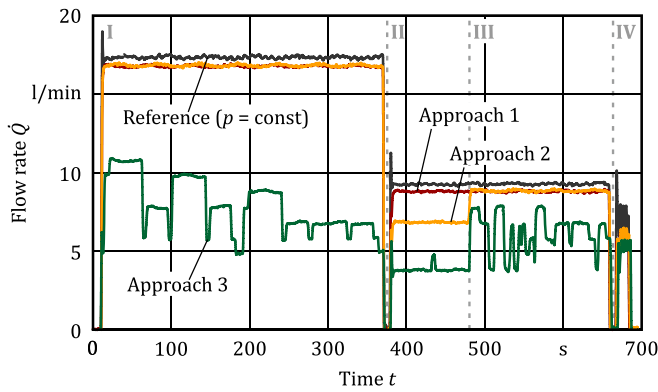

#### Process information

- I: Roughing (Milling cutter, D = 20 mm)
- II: Finishing (Milling cutter, D = 10 mm)
- III: Plunge cutting (Milling cutter, D = 10 mm)
- IV: Drilling (Drill, D = 8 mm)



Fig. 24. Flow rates for different approaches of adaptive cutting fluid supply [56].

finishing phases, to select appropriate flow rates and stored the commands in the generated NC-code. Taking into account additional process information, the simulation-based approach introduced a more complex strategy for locally optimising and adjusting the flow rate per NC command line based on the expected cutting conditions, i.e. the material removal rate. Fig. 24 shows the resulting flow rates for the three approaches compared to a reference setting (with constant pressure control) for an exemplary machining process. For the considered reference process, the adaptation of the flow rate (Approach 1) allowed for a reduction of the pump power by 12%. Using the simulation-based approach (Approach 3) the energy demand of the high-pressure pump was reduced by 81%, which corresponds to an overall energy saving of up to 37% for the entire machine tool.

Klocke et al. considered flow rate and pressure variations for an internal high-pressure cutting fluid supply (with up to 300 bar) in turning [125,127]. Their contributions compare the performance of flood cooling and internal high-pressure cutting fluid supply for turning of difficult-to-cut materials. Tool wear, chip formation and energy demand (per part) were set as evaluation criteria. Again, the findings indicate a potential for reducing the overall energy demand per part by approximately 40% and a significant increase of the material removal rate in combination with increased process stability when using a high-pressure cutting fluid supply.

#### 6.3.2. Alternatives to conventional cutting fluid supply concepts

While previously presented optimisation measures aim at demand-oriented and more efficient supply strategies, a more drastic reduction of the cutting fluid quantity is far more desirable. In this context, minimum quantity lubrication (MQL) acts as an enabling technology for near dry machining. Weinert et al. provide a comprehensive insight into the technological requirements and the potential of minimum quantity lubrication and dry machining [216]. The step to near dry machining involves various benefits regarding the economic and ecological impact of machine tools by drastically reducing the cutting fluid quantity in use as well as the electrical energy requirements for its supply and conditioning [82]. At the same time, transferring a manufacturing process to near dry machining often influences the complete production system and requires a careful revision of cutting tools, process parameters, and possibly the overall machine tool design [216]. Nowadays, near dry machining is mainly applied in high volume or large scaled industries, e.g. automotive and aerospace manufacturing. However, the implementation of respective high-performance processes requires specialised solutions, which are not available to small and medium-sized manufacturers. Solid lubrication is principally possible, but is rarely used in industrial practice and limited to very specific applications [44]. Hence, it is not considered to be a viable alternative in metal cutting applications.

Cryogenic cooling is emerging as an innovative process cooling technology which holds out the prospect of a considerable increase in productivity. Jawahir et al. provide an extensive overview of the current state of the art in cryogenic manufacturing processes [113]. Most commonly, cryogenic machining processes use liquefied nitrogen gas (LN<sub>2</sub>), which is inert, non-toxic, non-flammable as well as colour- and odourless. It is lighter than air and disperses after application, thus, reducing the effort for recirculation, conditioning and disposal of applied media compared to the use of conventional cutting fluids. Conversely, the production and the storage of the liquefied nitrogen gas (typically at -196 °C) is fairly energy intensive. Due to considerably improved cooling in the cutting zone, cryogenic machining allows for significantly increased material removal rates with lower tool wear [51], which, in turn, allows for shorter processing times, especially when machining difficult-to-cut materials. Exemplary studies on the cryogenic milling of Inconel 718 claim that cryogenic cooling presents the most energy efficient strategy compared to minimum quantity lubrication and conventional flood cooling [17,47]. However, the validity of this claim depends on the chosen frame of reference and system boundaries for the calculation of the specific energy demand, as is the case in the previously mentioned examples. While machining performance and tool wear are vastly improved with cryogenic cooling, a holistic evaluation of its impact on the energy efficiency of the entire production system is currently not available.

#### 6.4. Interim conclusion

From the reviewed literature, it can be concluded that a process-oriented control of the operational state and cutting fluid supply as well as the optimisation of process parameters are promising approaches to reduce the energy demand of machine tools in operation (Fig. 25). The choice of process parameters significantly affects the required energy for the cutting process. The main recommendation is to increase the material removal rate and, thus, productivity, while maintaining the required quality. One should keep in mind that increased feed rates and cutting speeds affect tool wear and can lead to higher process cooling requirements, which, in turn, have a negative impact on the overall energy demand. Additionally, an optimised tool path reduces air-cutting time and the energy demand. Still, these measures can only develop their full potential in combination with intelligent standby modes.

Many empirical models have been developed to support an energy efficient selection of process parameters over the last 30 years. However, the definition of the model coefficients often remains unclear and the empirical nature of the models causes strong dependencies on machine tool characteristics and other processing factors [227]. Furthermore, it can be stated that simple linear models based on the material removal rate neglect several process specific aspects. Especially,

#### Overall objectives

- Utilisation of differentiated standby modes (6.1)
- Decrease production time to increase efficiency
- Need-based and demand-oriented control strategies

#### Process parameters (6.2)

- Cutting parameters for maximised material removal
- Minimise air cutting through efficient tool path planning

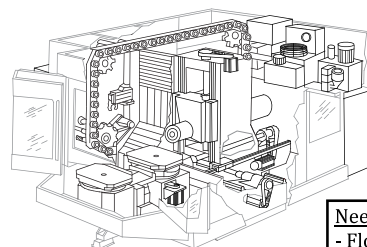

#### Need-based supply strategies (6.3)

- Flow rate control for need-based cutting fluid supply

Fig. 25. Most relevant measures to increase energy efficiency in operation of machine tools.



interdependencies between process parameters and part and tool features are not considered. Contrary to this, more sophisticated models reflect the process specific characteristics of the energy demand much better. Though, parameterisation is more challenging and transferability to other processes is very limited. Due to these issues, energy demand models are rarely used in process planning nowadays. In order to address this issue, future development should focus on the analysis of NC-codes and the subsequent optimisation thereof.

With respect to process cooling, it can be stated that dry machining or MQL offer a considerable potential to eliminate energy intensive supply units. In addition, need-based cutting fluid supply can decrease the energy demand significantly. From a technical point of view, adaptive cooling strategies require frequency inverters to control the pump power, which is already feasible with currently available industrial solutions (see Section 5.2.2). However, tool manufacturers usually do not provide data on the required amount of cutting fluid with respect to cutting conditions and workpiece materials. Moreover, software tools that consider adaptive cooling strategies are currently not available.

### 7. Transfer to machine tool industry

The research results presented so far impressively demonstrate the effectiveness and the savings potential of available energy efficiency measures. Although the technical feasibility of specific measures has been proven, practical restriction cannot be ruled out due to the research focus on individual components and measures as well as the given experimental conditions, which were often influenced by a predominantly academic point of view. In this context, open questions relate to possible synergies through combination of selected measures, economic feasibility, and acceptance from machine tool manufacturers and user.

Against this background, large-scale collaborative research projects were carried out, involving not only research institutions but machine tool and component manufacturers, as well as software developers for CAM and production scheduling applications. Each of these comprehensive case studies considered a variety of energy efficiency measures implemented in a machine tool demonstrator and investigated for a practically relevant reference process. The main results of three representative projects, namely *EWOTeK*, *Maxiem* and *NCplus*, are summarised in Figs. 26–28 [8,32,53].

These case studies consider different machine tool configurations and demonstrate savings potentials ranging from approximately 30 to 52% through implementation of various coordinated optimisation measures based on the approaches from the previous Chapters 4 to 6. Notably, the relative energy shares of the main units were increased in all presented case studies, thus, reducing the share of the support units, which do not directly contribute to the value adding process.

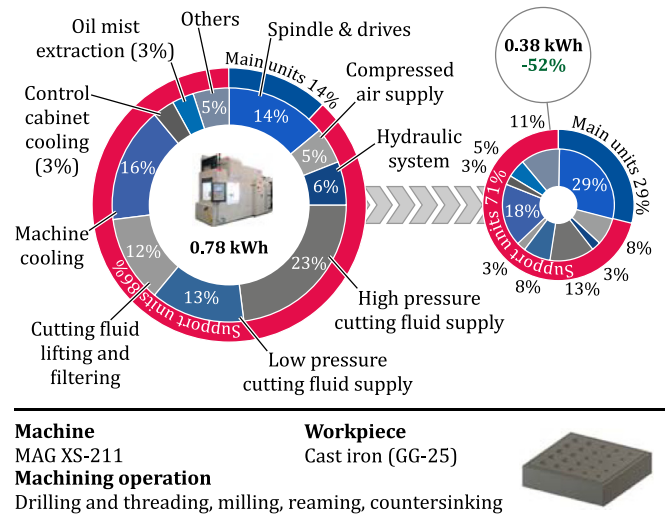

Fig. 27. Exemplary saving potential for machining of a reference workpiece achieved in the research project *Maxiem* [8].

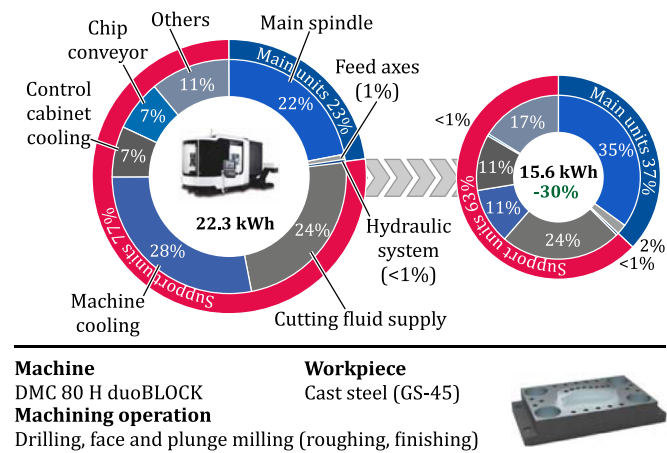

Fig. 28. Exemplary saving potential for machining of a reference workpiece achieved in the research project *NCplus* [101].

This way, the energy efficiency according to Eq. (1) is increased in all of the considered studies. All of the implemented measures were developed in cooperation with industrial partners and therefore represent solutions suitable for industrial use. Due to the convincing results of the collaborative projects, many solutions were then transferred into industrial applications. Hence, the following section provides a brief overview of relevant measures already available in the machine tool industry. Here, only those measures are considered that reduce the energy demand during use. Constructive measures, e.g. lightweight construction, are not taken into account.

In line with the most energy intensive components identified in Chapter 3, the fluid pumps of the cutting fluid supply and hydraulic system represent an essential focus for optimisation measures at machine tool manufacturers (see Section 3.2). Here, downsizing of pumps [160], a reduction of the pumps' motion frequency, and through-spindle coolant systems allow for considerable energy savings [161]. Regarding the main units, machine tool and component manufacturers have developed energy efficiency measures, which mainly reduce the electrical energy demand of spindles and drives [68,194]. Furthermore, brake energy recovery [71,106,194] and direct optical measuring systems for drive control optimisation [71] are often implemented to minimise the energy demand of work spindles and feed axes. Also, waste heat recovery systems [106] as well as LED lighting inside the machine tool workspace [68,218] are commonly applied measures.

Further available measures concern the coordinated control of individual components. Most measures aim to increase productivity

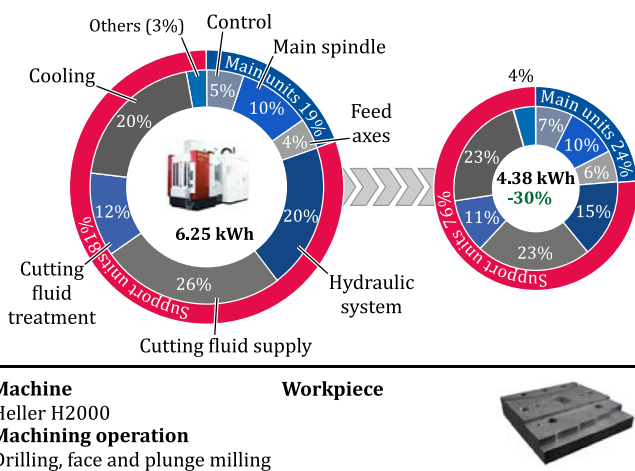

Fig. 26. Exemplary saving potential for machining of a reference workpiece achieved in the research project *EWOTeK* [32].

in order to reduce the machine operating time or to coordinate energy intensive operating states of several units. For instance, adjusting the cutting fluid supply parameters to actual process requirements via inverter-controlled fluid pumps minimises energy and resource demand [68,106]. The automatic adjustment of the feed axis positioning speed in accordance with spindle acceleration and deceleration times, which is described in Chapter 4, enables energy savings of up to 10% [68,152,160]. Alternatively, overlapping of operations [68,106,152], i.e. the specification of a machine code command before completing the previous one, or the control of pecking movements [68,160], reduces machining time and, thus, energy demand. In addition, auxiliary times can be reduced by using precise tactile system for a fast and reliable workpiece setup [71].

Another established approach to increase energy efficiency of machine tools is the use of energy monitoring systems and differentiated standby modes. Energy monitoring systems allow for the visualisation, control and strategic optimisation of the machine tool's energy requirements [68,194]. Consequently, this results in distinct standby functions, which automatically switch off peripheral units in case of idle times and ultimately minimises the machine tool's energy input in non-productive phases [68,71,106,160,194,218]. A more sophisticated approach considers a strategic machine tool selection, e.g. a 5-axis machining centre instead of a series of horizontal machining centres, to reduce transport efforts and cycle times, leading to energy savings of approximately 8% [161].

In recent years, energy efficiency has become an increasingly prominent topic in the machine tool industry. A growing environmental awareness, rising energy costs and increasingly specific (and in the future eventually obligatory) government regulations present relevant incentives to address energy efficiency in production engineering. In this context, an investigation carried out by DMG Mori Co. Ltd. compared a new machine to a 15-year-old model. The new machine tool used 45% less energy per year, which is equivalent to 2,650 kg CO<sub>2</sub> emissions savings [68]. In further work, a modern production machine was optimised for energy efficiency with regard to cutting parameters, standby modes, cutting fluid pumps and supply strategy, which led to energy savings of up to 17% [83].

Despite the availability of energy efficiency measures in the machine tool industry, the use in industrial practice falls short of expectations. Naturally, the decision for or against the procurement of energy efficiency features when purchasing or upgrading a machine tool depends on an economic evaluation, which is typically based on the return on investment, the payback period, or the net present value [86,87]. The return on investment depends on the investment costs and is also influenced by the electricity price [134]. Companies regularly demand short payback periods and the share of energy costs in their total costs is usually still low. Moreover, energy-related measures compete with investments in quality- or process-related measures [225]. This makes the implementation of energy efficiency measures more difficult as they are regularly associated with higher costs compared to standard variants [148]. In some cases, government institutions provide subsidies as an incentive to implement energy saving measures [45]. In this context, Götze et al. present an integrated energy-oriented method for the technical and economic evaluation of machine tools [88].

## 8. Summary and outlook

The growing global energy demand from industry results in significant ecological and economical costs. From the reviewed literature, it can be learned that the design of machine tools and their operation have high potential for energy savings in the industrial sector. Looking at the energy distribution of individual machine tools, the overall energy demand exceeds the required energy for the actual chip removal process by far. Moreover, even the variable energy demand (which correlates with the material processing) is relatively small compared to the fixed energy requirement, because of the high energy demand of the machine tools' support units and auxiliary systems. In particular, cooling

systems, cutting fluid supplies and hydraulic units have a decisive impact on the overall energy demand. Based on this finding, a definition for energy efficiency of machine tools has been proposed. The definition relates the energy demand of the main spindle to the overall energy. Consequently, a high spindle utilisation and a low energy demand of the support units are beneficial. While the definition is easy to apply, it is limited to electrical energy and does not consider indirect energy flows, e.g. pressurised air, coolants or tools.

Aiming to increase energy efficiency of machine tools, approaches for main and support units from research and industry have been reviewed in this paper. The main results are summarised in the respective interim conclusions. Nevertheless, several research topics remain:

- Investigation and evaluation for the replacement of pneumatic and hydraulic components with electromechanical actuators (for a media-free machine tool),
- robust thermo-mechanical models with low implementation effort (e.g. observer-based approaches) for productive use of warm-up periods,
- intelligent standby modes for machine tool components,
- strategies for retrofitting of existing machine tools with more energy efficient components.

Besides the design of machine tools, energy efficiency is largely determined by their operation. In this regard, process parameters should be selected to maximise productivity. However, side effects like increased tool wear or higher coolant requirements must be considered. Moreover, intelligent standby modes are essential to reduce energy demand at non-productive times. From the reviewed literature, it can also be learned that adaptive cooling supply and (near) dry machining offer significant potential for energy savings. Despite these potentials, only few applications can be found in the industry, due to the following open research topics:

- Investigation of process interdependencies, e.g. for productivity and tool wear, idle times and thermal stability, temperature build-up and machining accuracy,
- identification of actually required cutting fluid volume and pressure for demand-oriented supply strategies,
- further research of minimum quantity lubrication and near dry machining for a widespread use in the production industry,
- CAM tools for energy efficient selection of process parameters, trajectory optimisation and adaptive cooling strategies including self-optimisation based on process data.

The presented case studies demonstrate that a combination of different energy efficiency measures may decrease the energy demand between 30% and 52%. It can be summarised that high energy savings are technically already feasible. But many of these technologies are still in the prototype stage and not established in industry yet. Therefore, significant effort is recommended to transfer scientific knowledge into industrial application. Moreover, specific guidelines (e.g. Cecimo or Blue Competence) as well as regulations could help to speed up implementation. Financial incentives for machine tool users may also help decrease amortisation time and, thus, increase demand for energy efficiency measures. Increasing energy efficiency in industry is not only a technical but also an economical and governmental task across national borders.

## Acknowledgements

The authors thank the CIRP community for their technical contributions to this paper. In particular, many thanks are extended to H.-K. Tönshoff for the careful review of the manuscript and the valuable suggestions in the creation of the paper. Special thanks are dedicated to M. Gärtner, S. Kehne, R. Krüger, L. Onken and L. Petruschke for the support in the preparation of this paper.

## References

- [1] ABB Ltd. (2009) Energy Savings for Hydraulic Systems. *World Pumps* 514:14–16.
- [2] Abele E (2003) *Energieeffiziente Produktionsmaschinen durch Simulation in der Produktentwicklung: Ergebnisbericht des BMBF Verbundprojektes eSimPro*. Report, Technical University of Darmstadt.
- [3] Abele E (2015) *Simulationsgestützte Integration des Energie- und Ressourcenverbrauchs in die Auswahl alternativer Prozessketten in der Arbeitsvorbereitung (SIERPA)*. Report, Technical University of Darmstadt.
- [4] Abele E, Eisele C, Dittrich M, Kessing O, Klöblen W, Rudolph M, Rummel W (2013) *Schlussbericht zum Projekt eSimPro - Energieeffiziente Produktionsmaschinen durch Simulation in der Produktentwicklung*. Report, Technical University of Darmstadt.
- [5] Abele E, Eisele C, Schrems S (2012) Simulation of the Energy Consumption of Machine Tools for a Specific Production Task. *Leveraging Technology for a Sustainable World*. Springer, Berlin:233–237.
- [6] Abele E, Rothenbücher S, Schiffler A (2007) Digitally Controlled Output Filters for Improvement of Temperature Behavior of Machine Tool Main Spindle Drives. *Production Engineering Research and Development* 1(2):219–226.
- [7] Abele E, Schraml P, Beck M, Flum D, Eisele C (2019) Two Practical Approaches to Assess the Energy Demand of Production Machines. *Eco-Factories of the Future*. Springer, Cham:127–146.
- [8] Abele E, Sielaff T, Beck M (2013) *Schlussbericht zum Projekt Maxiemi: Maximierung der Energieeffizienz spanender Werkzeugmaschinen*. Report, Technical University of Darmstadt.
- [9] Abele E, Sielaff T, Holland L (2013) *Abschlussbericht Energie MSP - Energiebedarfsoptimierte Motorspindel und angepasster elektrischer Antriebsstrang - BMBF-Rahmenkonzept Forschung für die Produktion von morgen*. Report, Technical University of Darmstadt. <http://tubiblio.ulb-tu-darmstadt.de/63635/>.
- [10] Abele E, Sielaff T, Schiffler A, Rothenbücher S (2011) Analyzing Energy Consumption of Machine Tool Spindle Units and Identification of Potential for Improvements of Efficiency. *Globalized Solutions for Sustainability in Manufacturing*. Springer, Berlin: 280–285.
- [11] Abrahamsen F, Blaabjerg F, Pedersen JK, Thøgersen PB (2001) Efficiency-Optimized Control of Medium-Size Induction Motor Drives. *IEEE Transaction on Industrial Applications* 37(6):1761–1767.
- [12] Aggarwal A, Singh H, Kumar P, Singh M (2008) Optimizing power consumption for CNC turned parts using response surface methodology and Taguchi's technique – A comparative analysis. *Journal of Materials Processing Technology* 200 (1–3):373–384.
- [13] Akamatsu Y, Mori M (2004) Development of Eco-friendly Oil Jet Lubricated Angular Contact Ball Bearings for Machine Tools. *NTN Technical Review* 72:6–10.
- [14] Almeida AT de, Ferreira FJTE, Baoming G (2014) Beyond Induction Motors – Technology Trends to Move Up Efficiency. *IEEE Transactions on Industrial Applications* 50(3):2103–2114.
- [15] Altintas Y, Verl A, Brecher C, Uriarte L, Pritschow G (2011) Machine Tool Feed Drives. *CIRP Annals* 60(2):779–796.
- [16] Altintas Y, Kersing P, Biermann D, Budak E, Denkena B, Lazoglu I (2014) Virtual Process Systems for Part Machining Operations. *CIRP Annals* 63(2):585–605.
- [17] Aramcharoen A, Chuan SK (2014) An Experimental Investigation on Cryogenic Milling of Inconel 718 and its Sustainability Assessment. *Procedia CIRP* 14: 529–534.
- [18] Aramcharoen A, Mativenga PT (2014) Critical Factors in Energy Demand Modelling for CNC Milling and Impact of Toolpath Strategy. *Journal of Cleaner Production* 78:63–74.
- [19] Armendia M, Ghassempouri M, Ozturk E, Peysson F (2019) *Twin-Control: A Digital Twin Approach to Improve Machine Tools Lifecycle*. Springer, Cham.
- [20] Astakhov VP (2012) High-pressure supply of metalworking fluids. *Metalworking Fluids (MWFs) for Cutting and Grinding: Fundamentals and Recent Advances*. CCR Press, Sawston: 201–290.
- [21] Astakhov VP, Joksch S (2012) *Metalworking Fluids (MWFs) for Cutting and Grinding: Fundamentals and Recent Advances*. CRC Press, Sawston.
- [22] Balogun VA, Mativenga PT (2013) Modelling of Direct Energy Requirements in Mechanical Machining Processes. *Journal of Cleaner Production* 41:179–186.
- [23] Balogun VA, Edem IF, Mativenga PT (2016) E-smart Toolpath Machining Strategy for Process Planning. *International Journal of Advanced Manufacturing Technology* 86: 1499–1508.
- [24] Barrenetxea D, Alvarez J, Marquinez JI, Sanchez JA (2016) Grinding with Controlled Kinematics and Chip Removal. *CIRP Annals* 65(1):341–344.
- [25] Bayoumi AE, Yücesan G, Hutton DV (1994) On the Closed Form Mechanistic Modeling of Milling: Specific Cutting Energy, Torque, and Power. *Journal of Materials Engineering and Performance* 3(1):151–158.
- [26] Beck M, Helfert M, Burkhardt M, Abele E (2016) Rapid Assessment: Method to Configure Energy Performant Machine Tools in Linked Energy Systems. *Procedia CIRP* 48:514–519.
- [27] Beck M, Strobel N, Panten N, Richter M (2018) Energetische Vernetzung. *ETA - die Modell-Fabrik, Energieeffizienz weiter gedacht*. Report, Technical University of Darmstadt. 24–37.
- [28] Beier J, Thiede S, Herrmann C (2017) Energy Flexibility of Manufacturing Systems for Variable Renewable Energy Supply Integration: Real-Time Control Method and Simulation. *Journal of Cleaner Production* 141:648–661.
- [29] Bianchi N, Bolognani S, Frare P (2006) Design Criteria for High-Efficiency SPM Synchronous Motors. *IEEE Transactions on Energy Conversion* 21(2):396–404.
- [30] Bittencourt JL (2013) *Selbstoptimierende und bedarfsgerechte Steuerungsstrategien für Werkzeugmaschinen zur Steigerung der Energieeffizienz*. PhD-Thesis, RWTH Aachen University, Aachen.
- [31] Borgia S, Pellegrinelli S, Bianchi G, Leonisio M (2014) A Reduced Model for Energy Consumption Analysis in Milling. *Procedia CIRP* 17:529–534.
- [32] Brecher C, (Ed.) (2012) *Effizienzsteigerung von Werkzeugmaschinen durch Optimierung der Technologien zum Komponentenbetrieb - EWOTek: Verbundprojekt im Rahmenkonzept „Forschung für die Produktion von morgen, Ressourceneffizienz in der Produktion des Bundesministeriums für Bildung und Forschung (BMBF)*. Report, RWTH Aachen University, Aachen.
- [33] Brecher C, Bäuml S, Jasper D, Trieb J (2012) Energy Efficient Cooling Systems for Machine Tools. *Leveraging Technology for a Sustainable World*. Springer, Berlin:239–244.
- [34] Brecher C, Bäuml S, Trieb J (2012) Design of Energy Efficient Hydraulic Units for Machine Tools. *Sustainable Manufacturing*. Springer, Berlin:183–188.
- [35] Brecher C, Gerlach G (2012) Testing and Wear Analysis of HNS Spindle Ball Bearings Coated with a-C:H:W. *Tribology Transactions* 55(4):481–490.
- [36] Brecher C, Herfs W, Heyers C, Klein W, Trieb J, Beck E, Dorn T (2010) Ressourceneffizienz von Werkzeugmaschinen im Fokus der Forschung. *wt Werkstattstechnik online* 100(7/8):559–564.
- [37] Brecher C, Roissant J, Falker J (2013) Evaluation of an Internally Spring Preloaded Four Contact-Points Bearing for Spindle Units. *Production Engineering Research and Development* 7(2–3):195–201.
- [38] Brecher C, Jasper D, Fey M (2017) Analysis of New, Energy-Efficient Hydraulic Unit for Machine Tools. *International Journal of Precision Engineering and Manufacturing-Green Technology* 4(1):5–11.
- [39] Brecher C, Jasper D, Wennemer M, Klatt M (2016) Thermo Energetic Design of Machine Tools and Requirements for Smart Fluid Power Systems. *Proceedings of the 10th International Fluid Power Conference*:177–194.
- [40] Brecher C, Kunc M (2011) Reibkraftmodellierung von Profilschienenführungen: Mathematische Formulierung, Parametermittlung und Verifikation. *wt Werkstattstechnik online* 101(5):328–338.
- [41] Brecher C, Trieb J, Jasper D (2013) Energy Efficient Solutions for Hydraulic Units of Machine Tools. *Re-engineering Manufacturing for Sustainability*. Springer, Singapore: 191–196.
- [42] Brecher C, Weck M (2017) *Führungen, Lagerungen und Vorschubsysteme. Werkzeugmaschinen Fertigungssysteme: Konstruktion, Berechnung und messtechnische Beurteilung*. Springer, Berlin:203–404.
- [43] Brinksmeier E, Barbrecht M, Heinzel C, Koch T, Eckebrecht J (2009) Current Approaches in Design and Supply of Metalworking Fluids. *Tribology Transactions* 52(5):591–601.
- [44] Brinksmeier E, Meyer D, Huesmann-Cordes AG, Herrmann C (2015) Metalworking Fluids – Mechanisms and Performance. *CIRP Annals* 64(2):605–628.
- [45] Bundesministerium für Wirtschaft und Energie (2018). *Energieeffizienz und Prozesswärme aus erneuerbaren Energien in der Wirtschaft – Kredit und Zuschuss, Government directive*. [https://www.kfw.de/PDF/Download-Center/F%C3%B6rderprogramme-\(Inlandsf%C3%B6rderung\)/PDF-Dokumente/6000004389\\_m\\_295\\_ee\\_Prozessw%C3%A4rme.pdf](https://www.kfw.de/PDF/Download-Center/F%C3%B6rderprogramme-(Inlandsf%C3%B6rderung)/PDF-Dokumente/6000004389_m_295_ee_Prozessw%C3%A4rme.pdf) (accessed on 18.06.2020).
- [46] Bunse K, Vodicka M, Schönsleben P, Brühlhart M, Ernst FO (2011) Integrating energy efficiency performance in production management – Gap Analysis Between Industrial Needs and Scientific Literature. *Journal of Cleaner Production* 19(6–7):667–679.
- [47] Busch K, Hochmuth C, Pause B, Stoll A, Wertheim R (2016) Investigation of Cooling and Lubrication Strategies for Machining High-temperature Alloys. *Procedia CIRP* 41:835–840.
- [48] Calvanese ML, Albertelli P, Matta A, Taisch M (2013) Analysis of Energy Consumption in CNC Machining Centers and Determination of Optimal Cutting Conditions. *Re-Engineering Manufacturing for Sustainability*. Springer, Singapore, 227–232.
- [49] Cavagnino A, Vaschetto S, Ferraris L, Gmyrek Z, Agamloh E, Bramerdorfer G (2018) Towards an IE4 Efficiency Class for Induction Motors with Minimal Manufacturer Impact. In: *Proceedings of the IEEE Energy Conversion Congress and Exposition, 23.–27.09.2018, Portland*, 289–296.
- [50] Chen S, Song A, Sekiguchi T (2000) High Efficiency and Low Torque Ripple Control of Permanent Magnet Synchronous Motor Based on the Current Tracking Vector of Electromotive Force. In: *Proceedings of the 35th IAS Annual Meeting and World Conference on Industrial Applications of Electrical Energy, Conference Record of the IEEE Industry Applications Conference, 08.–12.10.2000, Rome*, 1725–1729.
- [51] Cordes S, Hübner F, Schaarschmidt T (2014) Next Generation High Performance Cutting by Use of Carbon Dioxide as Cryogenics. *Procedia CIRP* 14:401–405.
- [52] Dahms JB, Gutowski TG (2004) An Environmental Analysis of Machining. In: *Proceedings of the International Mechanical Engineering Congress and Exposition, . 15, 643–652*.
- [53] Denkena B (2013) *Abschlussbericht zum BMBF-Verbundprojekt NCplus: Prozess- und wertschöpfungsorientiert gesteuerte Werkzeugmaschine*. Report, Gottfried Wilhelm Leibniz University Hannover
- [54] Denkena B, Bergmann B, Rahner B-H (2018) Energy-Efficient Control of Dust Extraction for the Machining of Fibre-Reinforced Plastics. *Procedia CIRP* 78:49–54.
- [55] Denkena B, Dittrich M-A, Rahner B-H (2017) Smart and Energy-Efficient Dust Suction Concept for Milling of Fibre-Reinforced Plastics. *Production Engineering Research and Development* 11(6):723–729.
- [56] Denkena B, Helmecke P, Hülsemeyer L (2014) Energy Efficient Machining with Optimized Coolant Lubrication Flow Rates. *Procedia CIRP* 24:25–31.
- [57] Denkena B, Helmecke P, Hülsemeyer L (2015) Energy Efficient Machining of Ti–6Al–4V. *CIRP Annals* 64(1):61–64.
- [58] Denkena B, Hesse P, Gümmer O (2009) Energy Optimized Jerk-Decoupling Technology for Translatory Feed Axes. *CIRP Annals* 58(1):339–342.
- [59] Deutsches Institut für Normung, DIN EN 12417: Machine tools - Safety - Machining centres, DIN standard, Beuth, Berlin. <https://doi.org/10.31030/1510563>.
- [60] Deutsches Institut für Normung (2015) DIN EN 50598 (VDE 0160-201:2015-05). DIN standard, VDE, Berlin. <https://www.vde-verlag.de/normen/0100261/din-en-50598-1-vde-0160-201-2015-05.html> (accessed on 19.06.2019).
- [61] Deutsches Institut für Normung, (2018) *DIN EN 61800-9-1: Adjustable speed electrical power drive systems – Part 9-1: Ecodesign for power drive systems, motor starters, power electronics and their driven applications - General requirements for setting energy efficiency standards for power driven equipment using the extended product approach (EPA) and semi analytic model (SAM) (VDE 0160-109-1:2018-01)*, DIN standard, VDE: Berlin.
- [62] Devoldere T, Dewulf W, Depres W, Willems B, Duflou JR (2007) Improvement Potential for Energy Consumption in Discrete Part Production Machines.

- Advances in Life Cycle Engineering for Sustainable Manufacturing Businesses*, Springer, Tokyo, 311–316.
- [63] Diaz N, et al. (2010) Machine Tool Design and Operation Strategies for Green Manufacturing. In: *Proceedings of 4th CIRP International Conference on High Performance Cutting*, 271–276.
- [64] Diaz N, Redelsheimer E, Dornfeld D (2011) Energy Consumption Characterization and Reduction Strategies for Milling Machine Tool Use. *Globalized Solutions for Sustainability in Manufacturing*, Springer, Berlin 263–267.
- [65] Dictionary.com (2018) Efficiency. <http://www.dictionary.com/browse/efficiency> (accessed on 19.07.2018)
- [66] Dietmair A, Verl A (2010) Energy Consumption Assessment and Optimisation in the Design and Use Phase of Machine Tools. In: *Proceedings of the 17th CIRP International Conference on Life Cycle Engineering*, 116–121.
- [67] Dietmair A, Verl A (2009) Energy Consumption Forecasting and Optimisation for Machine Tools. *Modern Machinery Science Journal* 01:63–67.
- [68] DMG Mori Seiki Co. Ltd. (2014) DMG MORI Going Green with New Energy-Saving Functions. [https://www.dmgmori.co.jp/corporate/en/news/pdf/20140905\\_energy\\_e.pdf](https://www.dmgmori.co.jp/corporate/en/news/pdf/20140905_energy_e.pdf) (accessed on 11.12.2018)
- [69] Döbbeler B, Klocke F (2017) Process Oriented Choice of Lubricant Pressure and Volume Flow to Increase Machining Process Efficiency. *Procedia Manufacturing* 8:361–368.
- [70] Donmez MA, Hahn MH, Soons JA (2007) A Novel Cooling System to Reduce Thermally-Induced Errors of Machine Tools. *CIRP Annals* 56(1):521–524.
- [71] Dr. Johannes Heidenhain GmbH. Technische Information - Aspekte der Energieeffizienz von Werkzeugmaschinen. [https://www.heidenhain.de/fileadmin/pdb/media/img/751261\\_00\\_Energieeffizienz\\_WZM\\_de.pdf](https://www.heidenhain.de/fileadmin/pdb/media/img/751261_00_Energieeffizienz_WZM_de.pdf) (accessed on 11.06.2019)
- [72] Draganescu F, Gheorghie M, Doicin CV (2003) Models of machine tool efficiency and specific consumed energy. *Journal of Materials Processing Technology* 141(1):9–15.
- [73] Duflo J, Sutherland JW, Dornfeld D, Herrmann C, Jeswiet J, Kara S, Hauschild M, Kellens K (2012) Towards energy and resource efficient manufacturing: A processes and systems approach. *CIRP Annals* 61(2):587–609.
- [74] Dupont R (2015) Robust rotor dynamics for high-speed air bearing spindles. *Precision Engineering* 40:7–13.
- [75] Dresdner Freundeskreis der Werkzeugmaschinen- und Steuerungstechnik (DWM e.V.) (Ed.), Energieeffiziente Linearachsen für die Werkzeugmaschine. *Profilschienenführungen in Werkzeugmaschinen: Produktinnovationen - Anwendungserfahrungen - Randbedingungen*, 30.09.-01.10.2020, Dresden.
- [76] Abele Eberhard, Schraml Philipp, Eisele Christian (2012) Abschätzung des Energieverbrauchs durch Kennfelder. *Productivity Management* 17(4):26–28. GITO, Berlin.
- [77] Eisele C (2014) Simulationsgestützte Optimierung des elektrischen Energiebedarfs spanender Werkzeugmaschinen. PhD-Thesis, Technical University of Darmstadt.
- [78] Erkokmaz K, Layegh SE, Zaloglu I, Erdim H (2013) Feedrate optimization for freeform milling considering constraints from the feed drive system and process mechanics. *CIRP Annals* 62(1):395–398.
- [79] European Commission. Regulation 640/2009. <https://eur-lex.europa.eu/legal-content/DE/ALL/?uri=CELEX%3A32009R0640> (accessed on 02.03.2020)
- [80] Eyran A (2014) *Eco Manufactured transportation means from Clean and Competitive Factory: Project Final Report*. EMC2-Factory. <https://cordis.europa.eu/project/rcn/101388/reporting/en> (accessed on 29.07.2019).
- [81] Filippi A de, Ippolito R (1980) Forecast of the Electric Energy Requirement in a Mechanical Plant by Using a Stochastic Model. *CIRP Annals* 29(1):285–288.
- [82] Fratila D (2010) Macro-Level Environmental Comparison of Near-Dry Machining and Flood Machining. *Journal of Cleaner Production* 18(10-11):1031–1039.
- [83] Fujishima M, Shimano H, Mori M (2017) Reducing the Energy Consumption of Machine Tools. *International Journal of Automation Technology* 11(4):601–607.
- [84] Gavrilă H, Manescu V, Paltanea G, Scutaru G, Peter I (2017) New Trends in Energy Efficient Electrical Machines. *Procedia Engineering* 181:568–574.
- [85] Ghadimi P, Li W, Kara S, Herrmann C (2014) Integrated Material and Energy Flow Analysis towards Energy Efficient Manufacturing. *Procedia CIRP* 15:117–122.
- [86] Gontarz A, Schudeleit T, Wegener K (2015) Framework of a Machine Tool Configurator for Energy Efficiency. *Procedia CIRP* 26:706–711.
- [87] Gontarz AM, Hänni F, Weiss LB, Wegener K (2013) Machine Tool Optimization Strategies for Ecologic and Economic Efficiency. In: *Proceedings of the Institution of Mechanical Engineers, Part B: Journal of Engineering Manufacture*, 54–61.
- [88] Götz U, Koriath H-J, Kolesnikov A, Lindner R, Paetzold J (2012) Integrated Methodology for the Evaluation of the Energy- and Cost-Effectiveness of Machine Tools. *CIRP Journal of Manufacturing Science and Technology* 5(3):151–163.
- [89] Gutowski TG, Dahmus JB, Thiriez A (2006) Electrical Energy Requirements for Manufacturing Processes. In: *Proceedings of the 13th CIRP International Conference of Life Cycle Engineering*, 31.05.–02.06.2006, Leuven.
- [90] Hacksteiner M, Peherstorfer H, Bleicher F (2018) Energy efficiency of state-of-the-art grinding processes. *Procedia Manufacturing* 21:717–724.
- [91] Halevi Y, Carpanzano E, Montalbano G, Koren Y (2011) Minimum energy control of redundant actuation machine tools. *CIRP Annals* 60(1):433–436.
- [92] Harris P, Nolan S, O'Donnell GE, Meskell C (2013) Optimising Compressed Air System Energy Efficiency – The Role of Flow Metering and Exergy Analysis. *Re-engineering Manufacturing for Sustainability*, Springer, Singapore: 129–134.
- [93] He Y, Liu F, Wu T, Zhong F-P, Peng B (2011) Analysis and estimation of energy consumption for numerical control machining. In: *Proceedings of the Institution of Mechanical Engineers, Part B: Journal of Engineering Manufacture*, 255–266.
- [94] Heinemann T, Schraml P, Thiede S, Eisele C, Herrmann C, Abele E (2014) Hierarchical Evaluation of Environmental Impacts from Manufacturing System and Machine Perspective. *Procedia CIRP* 15:141–146.
- [95] Heinzl C, Meyer D, Kolkwitz B, Eckerbrecht J (2015) Advanced Approach for a Demand-Oriented Fluid Supply in Grinding. *CIRP Annals* 64(1):333–336.
- [96] Helfert M, Weber M (2018) Energieeffiziente Zerspanung mit Werkzeugmaschinen. *ETA - die Modell-Fabrik, Energieeffizienz Weiter Gedacht*, Report, Technical University of Darmstadt 13–16.
- [97] Helu M, Behmann B, Meier H, Dornfeld D, Lanza G, Schulze V (2012) Impact of green machining strategies on achieved surface quality. *CIRP Annals* 61(1):55–58.
- [98] Hesse P (2008) *Energieeffizientes Relativführungskonzept für ruckentkoppelte Vorschubachsen*, PhD-Thesis, Leibniz University Hannover.
- [99] Heyers C (2013) *Energieeffizienter Betrieb von Asynchron-Hauptspindelantrieben in Werkzeugmaschinen*. PhD-Thesis, RWTH Aachen University, Apprimus.
- [100] Hu S, Liu F, He Y, PENG B (2010) Characteristics of Additional Load Losses of Spindle System of Machine Tools. *Journal of Advanced Mechanical Design, Systems and Manufacturing* 4(7):1221–1233.
- [101] Hülsemeyer L (2016) *Energieeffizienz spanender Werkzeugmaschinen und bedarfsgerechter Betrieb am Beispiel der inneren Kühlschmierstoffzufuhr*. PhD-Thesis, Leibniz University Hannover.
- [102] International Energy Agency (IEA), Key World Energy Statistics 2017, 2017. [https://doi.org/10.1787/key\\_world\\_energy\\_stat-2017-en](https://doi.org/10.1787/key_world_energy_stat-2017-en)
- [103] International Energy Agency (IEA), Energy Efficiency: Industry, 2019. <https://www.iea.org/topics/energyefficiency/industry/> (accessed on 29.07.2019)
- [104] IEC (2014) Rotating electrical machines - Part 30-1: Efficiency classes of line operated AC motors (IE code)(60034-30-1:2014). NEN, Geneva.
- [105] IEC Rotating electrical machines - Part 2-1: Standard methods for determining losses and efficiency from tests (excluding machines for traction vehicles) (60034-2-1), NEN Geneva.
- [106] INDEX-Werke GmbH & Co.KG Hahn & Tessky (2019) ECO concept. [https://www.index-werke.de/fileadmin/user\\_upload/technology/energy/Eco\\_fluid\\_Broschuere.pdf](https://www.index-werke.de/fileadmin/user_upload/technology/energy/Eco_fluid_Broschuere.pdf) (accessed on 11.06.2019)
- [107] Industrieanzeiger (2019) Energieeffizienz: Viel Potenzial an Werkzeugmaschinen aufgedeckt und genutzt Verbrauch auf Bedarf reduziert. <https://industrieanzeiger.industrie.de/technik/fertigung/verbrauch-auf-bedarf-reduziert/> (Accessed on 27.01.2019).
- [108] International Panel on Climate Change (IPCC), Global Warming of 1.5°, Special report, 2018. [https://www.ipcc.ch/site/assets/uploads/sites/2/2019/06/SR15\\_Full\\_Report\\_High\\_Res.pdf](https://www.ipcc.ch/site/assets/uploads/sites/2/2019/06/SR15_Full_Report_High_Res.pdf) (accessed on 18.06.2020)
- [109] International Organization for Standardization (ISO). ISO 14955-1: Machine tools – Environmental evaluation of machine tools: Part 1: Design methodology for energy-efficient machine tools, ISO standard 2017, Beuth, Berlin.
- [110] ISO 14955-2: Machine tools – Environmental evaluation of machine tools: Part 2: Methods for measuring energy supplied to machine tools and machine tool components, ISO standard, 2018, Beuth, Berlin.
- [111] International Organization for Standardization (ISO). SO/DIS 14955-3: Machine tools – Environmental evaluation of machine tools: Part 3: Principles for testing metal-cutting machine tools with respect to energy efficiency, ISO standard, 2019, Beuth, Berlin.
- [112] Ispaylar H (1996) *Betriebseigenschaften von Profilschienen-Wälzführungen*. PhD-Thesis, RWTH Aachen University, Aachen.
- [113] Jawahir IS, Attia H, Biermann D, Duflo J, Klocke F, Meyer D, Newman ST, Pusa-vec F, Putz M, Rech J, Schulze V, Umbrello D (2016) Cryogenic Manufacturing Processes. *CIRP Annals* 65(2):713–736.
- [114] Jedrzejewski J, Kwasny W (2011) Study on Reducing Energy Consumption in Manufacturing Systems. *Journal of Machine Engineering* 11(3):7–20.
- [115] Jedrzejewski J, Kowal Z, Kwasny W, Modrzycki W (2005) High-Speed Precise Machine Tools Spindle Units Improving. *Journal of Materials Processing Technology* 162(163):615–621.
- [116] Jiang Z, Harrison DK, Cheng K (2003) Computer-Aided Design and Manufacturing of Off Scroll Compressors. *Journal of Materials Processing Technology* 138(1-3):145–151.
- [117] Junge F, Abele E, Vogel F (2017) Qualification of Aqueous Part Cleaning Machines for the Use of Waste Heat in Industrial Production Companies. *Procedia CIRP* 61:570–575.
- [118] Junge F, Helfert M, Abele E, Vogel F (2017) Increase in Energy Efficiency of Industrial Production Processes through Thermal Crosslinking of Cutting-Machine Tools and Cleaning Machines by Heat-Pump Technology. In: *Proceedings of the 12th IEA Heat Pump Conference*, P.3.7.7.
- [119] Kaminski J, Alvelid B (2000) Temperature Reduction in the Cutting Zone in Water-Jet Assisted Turning. *Journal of Materials Processing Technology* 106(1-3):68–73.
- [120] Kant G, Sangwan KS (2014) Prediction and Optimization of Machining Parameters for Minimizing Power Consumption and Surface Roughness in Machining. *Journal of Cleaner Production* 83:151–164.
- [121] Kara S, Bogdanski G, Li W (2011) Electricity Metering and Monitoring in Manufacturing Systems. *Globalized Solutions for Sustainability in Manufacturing*, Springer, Berlin: 1–10.
- [122] Kara S, Li W (2011) Unit Process Energy Consumption Models for Material Removal Processes. *CIRP Annals* 60(1):37–40.
- [123] Kianinejad K, Uhlmann E, Peukert B (2015) Investigation into Energy Efficiency of Outdated Cutting Machine Tools and Identification of Improvement Potentials to Promote Sustainability. *Procedia CIRP* 26:533–538.
- [124] Kioskeridis I, Margaritis N (1996) Loss minimization in induction motor adjustable-speed drives. *IEEE Transactions on Industrial Electronics* 43(1):226–231.
- [125] Klocke F, Lung D, Krämer A, Cayli T, Sangermann H (2013) Potential of Modern Lubricant Strategies on Cutting Performance. *Key Engineering Materials* 554-557:2062–2071.
- [126] Klocke F, Lung D, Sangermann H, Cayli T (2013) *Steigerung der Produktivität und Prozesssicherheit bei der Drehbearbeitung von Stählen durch den energieeffizienten Einsatz der Hochdruck-Kühlschmierstoff-Zufuhr*, Report, RWTH Aachen University, Klocke.
- [127] Klocke F, Schlosser R, Sangermann H (2012) *Evaluation of the Energy Consumption of a Directed Lubricant Supply with Variable Pressures and Flow Rates in Cutting Processes*. Sustainable Manufacturing, Springer, Berlin:203–209.
- [128] Koyama M, Fujii T, Uchida R, Kawabata T (1992) Space voltage vector-based new PWM method for large capacity three-level GTO inverter. In: *Proceedings of the 1992 International Conference on Industrial Electronics, Control, Instrumentation, and Automation*, 271–276.

- [129] Kramer MJ, McCallum RW, Anderson IA, Constantinides S (2012) Prospects for Non-Rare Earth Permanent Magnets for Traction Motors and Generators. *Journal of The Minerals, Metals and Materials Society* 64(7):752–763.
- [130] Kreitlein S, Kupfer I, Mühlbauer M, Franke J (2015) The Relative Energy Efficiency as Standard for Evaluating the Energy Efficiency of Production Processes Based on the Least Energy Demand. *Applied Mechanics and Materials* 805:11–18.
- [131] Kührke B (2011) Methode zur Energie- und Medienbedarfsbewertung spanender Werkzeugmaschinen, PhD-Thesis, Technical University of Darmstadt.
- [132] Kührke B, Schrems S, Eisele C, Abele E (2010) Methodology to assess the energy consumption of cutting machine tools. In: *Proceedings of the 17th CIRP LCE Conference*, 76–82.
- [133] Laptev I, Zahn P, Pritschow G (2015) Direct sliding mode current control of feed drives. *CIRP Annals* 64(1):373–376.
- [134] Lenz J, Kotschenreuther J, Westkämper E (2017) Energy Efficiency in Machine Tool Operation by Online Energy Monitoring Capturing and Analysis. *Procedia CIRP* 61:365–369.
- [135] Li W (2015) *Efficiency of Manufacturing Processes: Energy and Ecological Perspectives*. Springer, Switzerland.
- [136] Li W, Kara S (2011) An empirical model for predicting energy consumption of manufacturing processes: a case of turning process. In: *Proceedings of the Institution of Mechanical Engineers, Part B: Journal of Engineering Manufacture*, 1636–1646.
- [137] Li W, Zein A, Kara S, Herrmann C (2011) An Investigation into Fixed Energy Consumption of Machine Tools. *Globalized Solutions for Sustainability in Manufacturing*, Springer, Berlin:268–273.
- [138] Lin CL (2004) Use of the Taguchi Method and Grey Relational Analysis to Optimize Turning Operations with Multiple Performance Characteristics. *Materials and Manufacturing Processes* 19(2):209–220.
- [139] Lu C-H, Tsai C-C (2008) Adaptive Predictive Control With Recurrent Neural Network for Industrial Processes: An Application to Temperature Control of a Variable-Frequency Oil-Cooling Machine. *IEEE Transactions on Industrial Electronics* 55(3):1366–1375.
- [140] Lv J, Tang R, Tang W, Liu Y, Zhang Y, Jia S (2017) An investigation into reducing the spindle acceleration energy consumption of machine tools. *Journal of Cleaner Production* 143:794–803.
- [141] Madanchi N, Kurlle D, Winter M, Thiede S, Herrmann C (2015) Energy Efficient Process Chain: The Impact of Cutting Fluid Strategies. *Procedia CIRP* 29:360–365.
- [142] Madanchi N, Winter M, Thiede S, Herrmann C (2017) Energy Efficient Cutting Fluid Supply: The Impact of Nozzle Design. *Procedia CIRP* 61:564–569.
- [143] Mativenga PT, Rajemi MF (2011) Calculation of Optimum Cutting Parameters Based on Minimum Energy Footprint. *CIRP Annals* 60(1):149–152.
- [144] Mayr J, Jedrzejewski J, Uhlmann E, Alkan Donmez M, Knapp W, Härtig F, Wendt K, Moriawaki T, Shore P, Schmitt R, Brecher C, Würz T, Wegener K (2012) Thermal Issues in Machine Tools. *CIRP Annals* 61(2):771–791.
- [145] Meadows DH, Randers J, Meadows DL (2004) *The Limits to Growth: The 30-year Update*.
- [146] Melfi MJ (2009) Quantifying the Energy Efficiency of Motors Fed by Adjustable Frequency Inverters. In: *Proceedings of the 56th Annual Petroleum and Chemical Industry Conference, 14.–16.09.2009, Industry Applications Society, Anaheim, 1–7*.
- [147] Mert G, Waltemode S, Aurich JC (2015) How Services Influence the Energy Efficiency of Machine Tools: A Case Study of a Machine Tool Manufacturer. *Procedia CIRP* 29:287–292.
- [148] Meyer F (2014) Making Machine Tools Work More efficiently: Researchers are Reducing the Energy Consumption of Modern Machining Centres. [http://www.bine.info/fileadmin/content/Publikationen/Projekt-Infos/2014/Projekt\\_03-2014/ProjektInfo\\_0314\\_engl\\_internetx.pdf](http://www.bine.info/fileadmin/content/Publikationen/Projekt-Infos/2014/Projekt_03-2014/ProjektInfo_0314_engl_internetx.pdf) (accessed on 27.06.2019).
- [149] Möhring HC, Brecher C, Abele E, Fleischer J, Bleicher F (2015) Materials in machine tool structures. *CIRP Annals* 64(2):725–748.
- [150] Moradnazard M, Unver HO (2017) Energy Consumption Characteristics of Turn-Mill Machining. *International Journal Advanced Manufacturing Technology* 91(5-8):1991–2016.
- [151] Mori K, Bergmann B, Kono D, Denkena B, Matsubara A (2019) Energy Efficiency Improvement of Machine Tool Spindle Cooling System with On–Off Control. *CIRP Journal of Manufacturing Science and Technology* 25:14–21.
- [152] Mori M, Fujishima M, Inamasu Y, Oda Y (2011) A Study on Energy Efficiency Improvement for Machine Tools. *CIRP Annals* 60(1):145–148.
- [153] Mousavi S, Kara S, Kornfeld B (2014) Energy Efficiency of Compressed Air Systems. *Procedia CIRP* 15:313–318.
- [154] Munoz AA, Sheng P (1995) An Analytical Approach for Determining the Environmental Impact of Machining Processes. *Journal of Materials Processing Technology* 53(3-4):736–758.
- [155] NEFF Gewindetriebe GmbH (2018) Gewindetriebe und Spindelhubgetriebe 02/2018. [https://www.neff-gewindetriebe.de/fileadmin/Servicecenter/Kataloge/20180222\\_Kat\\_D\\_Downloadversion.pdf](https://www.neff-gewindetriebe.de/fileadmin/Servicecenter/Kataloge/20180222_Kat_D_Downloadversion.pdf) (accessed on 11.07.2019)
- [156] Nehler T (2018) Linking Energy Efficiency Measures in Industrial Compressed Air Systems with Non-Energy Benefits – A Review. *Renewable and Sustainable Energy Reviews* 89:72–87.
- [157] Neugebauer R, Wabner M, Rentzsch H, Ihlenfeldt S (2011) Structure Principles of Energy Efficient Machine Tools. *CIRP Journal of Manufacturing Science and Technology* 4(2):136–147.
- [158] Neugebauer R, Wertheim R, Hochmuth C, Schmidt G, Dix M (2010) Modelling of Energy and Resource-Efficient Machining. In: *Proceedings of the CIRP Conference of High Performance Cutting*, 295–300.
- [159] Newman ST, Nassehi A, Imani-Asrai R, Dhokia V (2015) Energy Efficient Process Planning for CNC Machining. *CIRP Journal of Manufacturing Science and Technology* 5(2):127–136.
- [160] Oda Y, Fujishima M, Kawamura Y, Hideta M (2012) Energy Reduction of Machine Tools. *Key Engineering Materials* 523-524:985–990.
- [161] Oda Y, Kawamura Y, Fujishima M (2012) Energy Consumption Reduction by Machining Process Improvement. *Procedia CIRP* 4:120–124.
- [162] Okwudire C, Rodgers J (2013) Design and Control of a Novel Hybrid Feed Drive for High Performance and Energy Efficient Machining. *CIRP Annals* 62(1):391–394.
- [163] Patterson MG (1996) What is Energy Efficiency? Concepts, Indicators and Methodological Issues. *Energy Policy* 24:377–390.
- [164] Peick H, Filtration device, Patent application DE102013006107A1, 2014.
- [165] Peng T, Xu X (2014) Energy-Efficient Machining Systems: A Critical Review. *International Journal Advanced Manufacturing Technology* 72(9-12):1389–1406.
- [166] Popp RSH, Liebl C, Zaeh MF (2018) A Multi-level Procedure to Evaluate the Energy Flexibility Potential of Production Machines. *Procedia CIRP* 67:75–80.
- [167] Popp RSH, Zaeh MF (2014) Determination of the Technical Energy Flexibility of Production Systems. *Advanced Materials Research* 1018:365–372.
- [168] Puii G, Olaru D, Puii V (2004) Friction Torque and Efficiency in Ball-Screw Systems. In: *Proceedings of the International Conference on Tribology*, 25–29.
- [169] Quintana G, Ciurana J, Ribatallada J (2011) Modelling Power Consumption in Ball-End Milling Operations. *Materials and Manufacturing Processes* 26(5):746–756.
- [170] Rahäuser R, Klemm P, Verl A, Kircher C (2013) Increasing the energy Efficiency in Metal Cutting Manufacturing through Demand Based Coolant Filtration. In: *Proceedings of the 20th CIRP International Conference on Life Cycle Engineering, Re-engineering Manufacturing for Sustainability*, 233–239.
- [171] Rahmani M, Krall S, Bleicher F (2015) Experimental Investigations on Stick-Slip Phenomenon and Friction Characteristics of Linear Guides. *Procedia Engineering* 100:1023–1031.
- [172] Rajemi MF, Mativenga PT, Aramcharoen A (2010) Sustainable Machining: Selection of Optimum Turning Conditions Based on Minimum Energy Considerations. *Journal of Cleaner Production* 18(10-11):1059–1065.
- [173] Rangarajan A, Dornfeld D (2004) Efficient Tool Paths and Part Orientation for Face Milling. *CIRP Annals* 53(1):73–76.
- [174] Rasch FO, Vigeland T, Bjørke Ø (1981) Hydraulic Chipbreaking. *CIRP Annals* 30(1):333–335.
- [175] Regel J, Xu Du, Brüning M, Wittstock V, Putz M (2018) Evaluation of Thermo-Energetic Behavior for demand-Oriented Operating of Machine Tool Cooling Systems. *Procedia Manufacturing* 21:213–220.
- [176] Rentsch R, Heinzl C (2015) Development of a Discrete Event Model for Energy and Resource Efficient Milling. *Procedia CIRP* 31:441–446.
- [177] Riemer B, Herold T, Hameyer K (2012) Impact Assessment of Machine Tool Auxiliary Drives Oversizing to Energy Efficiency Aspects. *Sustainable Manufacturing*, Springer, Berlin:77–81.
- [178] Rossaint J (2014) *Steigerung der Leistungsfähigkeit von Spindellagern durch optimierte Lagergeometrien*. PhD-Thesis, RWTH Aachen Apprimus.
- [179] Rothenbücher S, Schiffler A, Bauer J (2019) Die Speisung macht's, *Werkstatt +Betrieb*: 62–65.
- [180] Saidur R, Rahim NA, Hasanuzzaman M (2010) A Review on Compressed-Air Energy Use and Energy Savings. *Renewable and Sustainable Energy Reviews* 14(4):1135–1153.
- [181] Salgado DR, Alonso FJ (2008) Optimal Machine Tool Spindle Drive Gearbox Design. *International Journal of Advanced Manufacturing Technology* 37(9-10):851–860.
- [182] Sangermann H (2013) Hochdruck-Kühlschmierstoffzufuhr in der Zerspaltung. PhD-Thesis, RWTH Aachen University, Apprimus.
- [183] Schischke K (2012) *Energy-Using Product Group Analysis - Lot 5: Machine tools and related machinery*. Report, Fraunhofer IZM, Berlin.
- [184] Schleinkofer U, Laufer F, Zimmermann M, Roth D, Bauernhansl T (2018) Resource-Efficient Manufacturing Systems Through Lightweight Construction by Using a Combined Development Approach. *Procedia CIRP* 72:856–861.
- [185] Schlosser R, Klocke F, Lung D (2011) *Sustainability in Manufacturing – Energy Consumption of Cutting Processes*, Springer, Berlin.
- [186] Schmidt H, Schwartz J (2014) Energy-Efficient Minimal Quantity Lubrication for High-Speed Spindles. *Evolution* . <http://evolution.skf.com/us/energy-efficient-minimal-quantity-lubrication-for-high-speed-spindles/> (Accessed on 11.09.2014).
- [187] Schott P, Ahrens R, Bauer D, Hering F, Keller R, Pullmann J, Schel D, Schimmelpfennig J, Simon P, Weber T, Abele E, Bauernhansl T, Fridgen G, Jarke M, Reinhardt G (2018) Flexible IT Platform for Synchronizing Energy Demands with Volatile Markets. *it - Information Technology* 60(3):155–164.
- [188] Schudeleit T, Züst S, Weiss L, Wegener K (2016) The Total Energy Efficiency Index for Machine Tools. *Energy* 102:682–693.
- [189] Schulz J, Popp RS-H, Scharmer VM, Zaeh MF (2018) An IoT Based Approach for Energy Flexible Control of Production Systems. *Procedia CIRP* 69:650–655.
- [190] Schulz M, Lambert L, Marquardt R (2013) Dimensioning of Modular High Frequency converter for drives. In: *Proceedings of the 5th IEEE Annual International Energy Conversion Congress and Exhibition in the Asia Pacific Region, 03.–06.06.2013, Melbourne, 675–680*.
- [191] Shell Lubricants. Energy-Efficient Hydraulic Fluid. *World Pumps* 8:8.
- [192] Shivakumar EG, Somasekhar VT, Mohapatra KK, Gopakumar K, Umanand L, Sinha SK (2001) A Multi Level Space Phasor Based PWM Strategy for an Open-End Winding Induction Motor Drive Using Two Inverters with Different DC Link Voltages. In: *Proceedings of the 4th IEEE International Conference on Power Electronics and Drive Systems, 25.10.2001, Denpasar, 169–175*.
- [193] Sielaff T (2017) Zum Einsatz von Synchronreluktanzmotoren in Motorspindeln für Universal-Bearbeitungszentren, PhD-Thesis, RWTH Aachen University, Shaker.
- [194] Siemens AG (2011) SINUMERIK Ctrl-Energy: Maximum Energy Efficiency for the Machine Tool. <https://c4b.gss.siemens.com/resources/articles/e20001-a1440-p610-x-7600.pdf> (Accessed on 03.04.2020)
- [195] Soković M, Mijanović K (2001) Ecological Aspects of the Cutting Fluids and its Influence on Quantifiable Parameters of the Cutting Processes. *Journal of Materials Processing Technology* 109(1-2):181–189.
- [196] Sozer Y, Torrey DA, Reva S (2000) New Inverter Output Filter Topology for PWM Motor Drives. *IEEE Transactions on Power Electronics* 15(6):1007–1017.
- [197] Sparks T, Chase G (2016) *Filters and Filtration Handbook*, Butterworth-Heinemann, Oxford.

- [198] Technische Informationsbibliothek (TIB) (2019) Energiebedarfsoptimierte Motorspindel und angepasster elektrischer Antriebsstrang <https://www.tib.eu/de/suchen/id/TIBKAT%3A779026217/Energiebedarfsoptimierte-Motorspindel-und-angepasster/> (accessed on 23.01.2019)
- [199] Thiede S, Bogdanski G, Herrmann C (2012) A Systematic Method for Increasing the Energy and Resource Efficiency in Manufacturing Companies. *Procedia CIRP* 2:28–33.
- [200] Tönshoff H-K (1995) *Werkzeugmaschinen: Grundlagen*, Springer, Berlin.
- [201] Triebe MJ, Mendis GP, Zhao F, Sutherland JW (2018) Understanding Energy Consumption in a Machine Tool through Energy Mapping. *Procedia CIRP* 69:259–264.
- [202] Triebe MJ, Zhao F, Sutherland JW (2019) Achieving Energy Efficient Machine Tools by Mass Reduction through Multi-Objective Optimization. *Procedia CIRP* 80:73–78.
- [203] U.S. Energy Information Administration (EIA), International Energy Outlook 2017, 2017. [https://www.eia.gov/outlooks/ieo/pdf/0484\(2017\).pdf](https://www.eia.gov/outlooks/ieo/pdf/0484(2017).pdf) (accessed on 18.06.2020)
- [204] U.S. Energy Information Administration. Office of Energy Consumption and Efficiency Statistics. *Manufacturing Energy Consumption Survey*. (Accessed on 02.11.2018).
- [205] Umweltbundesamt (2019) Stromverbrauch: Entwicklung des Stromverbrauchs nach Sektoren. <https://www.umweltbundesamt.de/daten/energie/stromverbrauch> (Accessed on 29.07.2019)
- [206] van de Beld C (2018) The scroll compressor: quiet and easy. <http://theworkshopcompressor.com/learn/compressor-types/scroll-compressor/> (Accessed on 08.12.2018)
- [207] Verband Deutscher Maschinen- und Anlagenbau e.V.. *VDMA 34179:2019-04: Measurement instruction to determine the energy- and resource demand of machine tools for mass production*, Beuth, Berlin.
- [208] Verein Deutscher Werkzeugmaschinen (VDW), Market Report 2015: The German Machine Tool Industry and its Position in the World Market, 2015. [https://wzm.vdma.org/documents/106072/650870/pub\\_vdw%20marktbericht\\_2015.pdf/6b0c9689-da6e-4384-9fcc-2324e45e3c99](https://wzm.vdma.org/documents/106072/650870/pub_vdw%20marktbericht_2015.pdf/6b0c9689-da6e-4384-9fcc-2324e45e3c99) (accessed on 18.06.2020)
- [209] Verl A, Frey S (2010) Correlation between feed velocity and preloading in ball screw drives. *CIRP Annals* 59(1):429–432.
- [210] Verl A, (Ed.) (2016) *Steuerung des Energiebedarfs in der Fertigung und Steigerung der Energieeffizienz durch Automatisierung: Abschlussbericht FOR 1088 ECOMATION*. Report, VDI, Düsseldorf.
- [211] Vijayaraghavan A, Dornfeld D (2010) Automated Energy Monitoring of Machine Tools. *CIRP Annals* 59(1):21–24.
- [212] Waide P, Brunner CU (2011) Energy-Efficiency Policy Opportunities for Electric Motor-Driven Systems. *IEA Energy Papers* 7. <https://doi.org/10.1787/5kkg52gb9gjd-en>. (Accessed on 02.03.2020).
- [213] Wang Q, Liu F, Wang X (2014) Multi-Objective Optimization of Machining Parameters Considering Energy Consumption. *Journal of Advanced Mechanical Design, Systems and Manufacturing* 71:1133–1142.
- [214] Wegener K, Mayr J, Merklein M, Behrens B-A, Aoyama T, Sulitka M, Fleischer J, Groche P, Kaftanoglu B, Jochum N, Möhring H-C (2017) Fluid Elements in Machine Tools. *CIRP Annals* 66(2):611–634.
- [215] Wei C, Lai R (2011) Kinematical Analyses and Transmission Efficiency of a Pre-loaded Ball Screw Operating at High Rotational Speeds. *Mechanism and Machine Theory* 7:880–898.
- [216] Weinert K, Inasaki I, Sutherland JW, Wakabayashi T (2004) Dry Machining and Minimum Quantity Lubrication. *CIRP Annals* 53(2):511–537.
- [217] Welsch A (2010) DE102010056567A1: Liquid-air cooling system. Patent.
- [218] Yamazaki Mazak UK Ltd. (2019) Advanced Technology & Environmentally Friendly. <https://www.mazakeu.co.uk/machines-technology/technology/ecofriendly/> (Accessed on 11.06.2019)
- [219] Yan J, Li L (2013) Multi-Objective Optimization of Milling Parameters – the Trade-Offs Between Energy, Production Rate and Cutting Quality. *Journal of Cleaner Production* 52:462–471.
- [220] Yang F, Taylor AR, Bai H, Cheng B, Khan AA (2015) Using d–q Transformation to Vary the Switching Frequency for Interior Permanent Magnet Synchronous Motor Drive Systems. *IEEE Transactions on Transportation Electrification* 1(3):277–286.
- [221] Yoon H-S, Lee J-Y, Kim H-S, Kim M-S, Kim E-S, Shin Y-J, Chu W-S, Ahn S-H (2014) A Comparison of Energy Consumption in Bulk Forming, Subtractive, and Additive Processes: Review and Case Study. *International Journal of Precision Engineering and Manufacturing-Green Technology* 1(3):261–279.
- [222] Yoon H-S, Moon J-S, Pham M-Q, Lee G-B, Ahn S-H (2013) Control of Machining Parameters for Energy and Cost Savings in Micro-Scale Drilling of PCBs. *Journal of Cleaner Production* 54:41–48.
- [223] Yoshitsugu J, Inoue K, Hiraki E, Nakaoka M (2001) Resonant DC link snubber-assisted soft switching inverter type AC servo driver with low common mode current characteristics. In: *Proceedings of the IEEE International Conference on Power Electronics and Drive Systems, Piscataway*, 494–499.
- [224] Yuen A, Zhang K, Altintas Y (2013) Smooth trajectory generation for five-axis machine tools. *International Journal of Machine Tools and Manufacture* 71:11–19.
- [225] Zein A (2012) *Transition Towards Energy Efficient Machine Tools*, Springer, Berlin.
- [226] Zhao GY, Liu ZY, He Y, Cao HJ, Guo YB (2017) Energy Consumption in Machining: Classification, Prediction, and Reduction Strategy. *Energy* 133:142–157.
- [227] Zhou L, Li J, Li F, Meng Q, Li J, Xu X (2016) Energy Consumption Model and Energy Efficiency of Machine Tools: A Comprehensive Literature Review. *Journal of Cleaner Production* 112:3721–3734.